
	Page
Introduction.....	1 - 10
Seal-Lok O-Ring Face Seal Fittings.....	Section A
Introduction.....	A5
Visual Index.....	A2
Triple-Lok 37° Flare Fittings.....	Section B
Introduction.....	B6
Visual Index.....	B2
Ferulok Flareless Bite Type Fittings.....	Section C
Introduction.....	C4
Visual Index.....	C2
Intru-Lok Flareless Bite Type Fittings.....	Section D
Introduction.....	D3
Visual Index.....	D2
EO and EO-2 Metric Bite Type Fittings.....	Section E
Introduction.....	E6
Visual Index.....	E2
Pipe Fittings and Port Adapters.....	Section F
Introduction.....	F4
Visual Index.....	F2
Pipe Swivels Adapters.....	Section G
Introduction.....	G3
Visual Index.....	G2
JIS Fittings Adapters.....	Section H
Introduction.....	H3
Visual Index.....	H2

Continued



	Page
K4 BSP Adapters	Section I
Introduction.....	I3
Visual Index	I2
Komatsu Style Adapters	Section J
Introduction.....	J3
Visual Index	J2
Conversion Adapters	Section K
Visual Index	K2
Hydraulic Code 61/62 Flange Connections & Components	Section L
Introduction.....	L5
Visual Index	L2
Diagnostic, Orifice, Bleed Adapters, Screen and Specialty Fittings	Section M
Introduction.....	M3
Visual Index	M2
O-Rings and Seals.....	Section N
Visual Index	N2
ParKlamp Inch Tube Clamps.....	Section O
Introduction.....	O4
Visual Index	O2
Metric Clamps.....	Section P
Introduction.....	P3
Visual Index	P2
Metric Tube.....	Section Q
Introduction.....	Q3
Assembly and Installation.....	Q3

Continued



	Page
Fabricating Equipment.....	Section R
<i>Visual Index</i>	<i>R2</i>
Assembly/Installation.....	Section S
<i>Port End Assembly</i>	<i>S3</i>
<i>Tube End Preparation</i>	<i>S12</i>
<i>Seal-Lok O-Ring Face Seal Fittings and UPTC Assembly</i>	<i>S13</i>
<i>Triple-Lok 37° Flare Fittings.....</i>	<i>S20</i>
<i>Ferulok Flareless Bite Type Fittings.....</i>	<i>S23</i>
<i>Intru-Lok Flareless Bite Type Fittings.....</i>	<i>S27</i>
<i>EO Metric Bite Type Fittings</i>	<i>S28</i>
<i>EO-2 Metric Bite Type Fittings</i>	<i>S32</i>
<i>Bulkhead Locknut Assembly.....</i>	<i>S35</i>
<i>Pipe Swivel Assembly.....</i>	<i>S35</i>
<i>Routing and Clamping Recommendations.....</i>	<i>S36</i>
<i>Bending Tips.....</i>	<i>S39</i>
<i>Plumbing and Assembly Hints.....</i>	<i>S40</i>
General Technical	Section T
<i>Size.....</i>	<i>T4</i>
<i>Temperature.....</i>	<i>T9</i>
<i>Application.....</i>	<i>T11</i>
<i>Media.....</i>	<i>T16</i>
<i>Pressure</i>	<i>T24</i>
<i>How To Order (TFD Standard Nomenclature Construction).....</i>	<i>T29</i>
<i>Port Details</i>	<i>T32</i>

Continued



Appendix	Section U
<i>Fitting Materials</i>	<i>U2</i>
<i>Selection of Fitting Type.....</i>	<i>U4</i>
<i>Pre-Setting Tools</i>	<i>U9</i>
<i>Flaring Tools</i>	<i>U11</i>
<i>Counterbores and Taps</i>	<i>U13</i>
<i>Reference Material</i>	<i>U14</i>
<i>Metric Conversions.....</i>	<i>U17</i>
<i>Glossary</i>	<i>U19</i>
Numeric Index, Fitting End Size Chart & Offer of Sale.....	Section V

Continued



TABLE
OF
CONTENTS



Industrial Tube Fittings, Adapters and Equipment

Catalog 4300 December 2011

aerospace
climate control
electromechanical
filtration
fluid & gas handling
hydraulics
pneumatics
process control
sealing & shielding



ENGINEERING YOUR SUCCESS.



Together, we can keep expectations high and equipment maintenance low.



Trap-Seal™ O-ring, with its revolutionary trapezoidal shape, dramatically improves seal retention.



Robust Port Stud™ SAE adjustable connector allows for remarkably easier assembly.



Superior Plating™ has unrivaled corrosion and rust protection reducing replacement costs.

Step up to even greater leak-free security and rely on peak fitting performance that lasts longer than ever before. Parker never stops targeting the challenges of connection component designs and performance. With our ever-growing exclusive innovations, we are making sure our components extend their like-new integrity even further. We are committed to setting new standards and raising the industry bar to a new level. To learn more, call 1-800-C-Parker or visit www.fittingsthatraisethebar.com.

aerospace
climate control
electromechanical
filtration
fluid & gas handling
hydraulics
pneumatics
process control
sealing & shielding



ENGINEERING YOUR SUCCESS.

www.parker.com 1 800 C-Parker

⚠ WARNING

FAILURE OR IMPROPER SELECTION OR IMPROPER USE OF THE PRODUCTS AND/OR SYSTEMS DESCRIBED HEREIN OR RELATED ITEMS CAN CAUSE DEATH, PERSONAL INJURY AND PROPERTY DAMAGE.

This document and other information from Parker Hannifin Corporation, its subsidiaries and authorized distributors provide product and/or system options for further investigation by users having technical expertise. It is important that you analyze all aspects of your application and review the information concerning the product or system in the current product catalog. Due to the variety of operating conditions and applications for these products or systems, the user, through its own analysis and testing, is solely responsible for making the final selection of the products and systems and assuring that all performance, safety and warning requirements of the application are met.

The products described herein, including without limitation, product features, specifications, designs, availability and pricing, are subject to change by Parker Hannifin Corporation and its subsidiaries at any time without notice.

Offer of Sale

The items described in this document are hereby offered for sale by Parker Hannifin Corporation, its subsidiaries or its authorized distributors. This offer and its acceptance are governed by the provisions stated in the "Offer of Sale."

Table of Contents

O-Ring Face Seal Tube Fittings	Seal-Lok	A
37° Flare Tube Fittings and Adapters	Triple-Lok & Triple-Lok 2	B
Flareless Bite Type Fittings	Ferulok	C
	Intru-Lok	D
Metric Bite Type Fittings	EO and EO-2	E
Adapters	Pipe Fittings and Port Adapters	F
	Pipe Swivels	G
	JIS Fittings	H
	K4 BSP Adapters	I
	Komatsu Style Adapters	J
	Conversion Adapters	K
Code 61/62 Flange Connections	Hydraulic Flanges & Components	L
Diagnostic, Orifice, Bleed Adapters, Screen and Specialty Fittings		M
O-Rings and Seals		N
Tube Clamps	ParKlump Inch Tube Clamps	O
	Metric Clamps	P
Tube	Metric Tube	Q
Fabricating Equipment	Equipment	R
Assembly / Installation		S
General Technical		T
Appendix		U
Numeric Index, Fitting End Size Chart and Offer of Sale		V

PRODUCT SPOTLIGHT

The Latest From Parker, Your Fitting Authority.

Added Value

The Parker advantage you can count on

When our name is on the product or service, you can be sure it includes Parker innovations and exclusives developed to maximize the leak-free performance and service life of your hydraulic connections. Here are some of our industry-leading examples.



Competitor A



Parker

Fittings exposed for 240 hours to neutral salt spray test ASTM B117 (independent testing)

Superior Plating provides unrivaled protection against corrosion, even in the harshest conditions. Parker fittings and adapters with this valuable enhancement exceed SAE red rust requirements and competitors' performance by far.

www.ravagesofredrust.com




ACEsolutions™ including our unique Trap-Seal™ O-ring and Robust Port Stud™ virtually eliminate problems like O-ring pop-out and washer damage that cause potential leaks in standard SAE connections.

www.fittingsthatraisethebar.com



TABLE OF CONTENTS




ToolSpec™ is the quick, easy online way to determine the right tube fitting tool and tooling information for your particular need, saving valuable time on the job. Just select

and enter your criteria, and this exclusive Parker system displays the appropriate product selection and details. Find it fast at www.tfdtoolspec.com.



Custom Products are an unsurpassed Parker advantage. Our dedicated facilities manufacture custom fittings, flanges and adapters precisely to your specifications or drawings – responsively and efficiently. For assistance, e-mail customfittings@Parker.com

Parker SAE Aluminum Fittings

save weight, resist corrosion and conserve energy resources



When your application requires corrosion-resistant, lighter weight components that perform reliably in a range of environments, specify Parker's SAE aluminum fittings.

Ideal for mobile hydraulic systems, their lightweight advantage reduces overall vehicle weight and costs, and their "green" eco-friendly anodized coating improves corrosion resistance. They make system conversion simple too, with no need for redesign.



Compare the weight of a **steel/ stainless steel** fitting (top) to that of an **aluminum** fitting (bottom). Aluminum fittings are approximately **65% lighter**.

Parker aluminum fittings are ideal for use in agricultural, military, marine, mining and transportation applications where lighter weight and corrosion resistance are required.



Get the substantial advantages:

- Up to 65% lighter than comparable steel and stainless steel fittings
- Superior corrosion resistance over comparable steel fittings
- Meets SAE J1453 and J514 fittings' dimension standards, eliminating system redesign and minimizing conversion costs
- Leak-free seal reliability with Parker's patented Trap-Seal™ O-ring and Robust Port Stud™
- Available in most any size, configuration or color



Parker Fittings with XTR Coating

for extreme resistance to corrosion



An outstanding advantage for equipment in highly caustic applications and environments, Parker fittings with XTR (Extreme-Resistance) Coating withstand corrosion more than seven times longer than the SAE standard of 96 hours. In fact, Parker's proprietary formulation has been **tested to resist corroding for more than 720 hours.**

In applications where connections come in contact with nitrogen-based fertilizers, salt spray and other aggressive chemicals, standard hose and tube fittings become severely corroded. In fact, corrosion can begin to occur in as few as 14 days, putting assemblies at increased risk of early failure, causing unnecessary and costly equipment downtime.

End users have been asking for an improvement to industry-standard hose and tube fittings to extend the life of their equipment. Parker's XTR Coating with unprecedented corrosion resistance is the answer.

Where systems are exposed to highly corrosive external conditions, Parker's XTR Coating is a valuable advantage. Ideal applications for Parker fittings and adapters with XTR Coating include construction, agriculture, utility, intermodal transportation, snow/ice removal equipment, above-ground mining, processing plants, car washes and other similar uses with high-corrosive conditions.

For manufacturers shipping vehicles, equipment and systems overseas, XTR Coated Parker components

provide the level of protection critical to maintaining the factory-new look of those products on arrival.

In addition, Parker XTR Coating is compliant with environmental restrictions worldwide, including RoHS, ELV, and REACH.*

Parker products with XTR Coating assure all the leak-free performance and installation advantages that our customers expect. Even the assembly torque remains the same. For unmatched quality, service and support, now with extreme corrosion resistance, specify Parker hose and tube fitting products with XTR Coating.

Parker steel fittings can be ordered with the XTR Coating, offering corrosion protection above the standard zinc trivalent chromium. The most common configurations can be ordered, including Seal-Lok, Triple-Lok and Pipe Fittings.

*European Union restrictions for electronics products (Directive 2002/95/EG of European Union), Restrictions of Hazardous Substances Directive" – RoHS – 1st July 2006), automobile products (Directive 2000/53/EG of European Union – "End of Life Vehicle Directive" – ELV – 1st July 2007), and chemical products ("Registration, Evaluation, and Authorization of Chemicals Directive" – REACH – in preparation).



Universal Push-to-Connect (UPTC) Assembly

for unprecedented savings, from product design to maintenance

TABLE
OF
CONTENTS



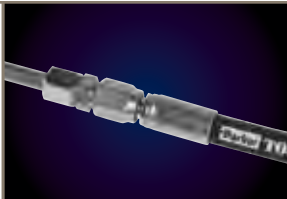
Push.



Click.



Done.



“Push, click, done” literally describes how simple it is to achieve reliable leak-free assemblies with Parker’s UPTC hose and tube assembly. That alone yields direct savings in time, equipment costs, rework and warranties. Unlike other push-to-connect assemblies, it’s also universally compatible.

Parker UPTC delivers:

- Substantial assembly efficiencies – no special tools
- Assured proper connections – with both tactile and visual indicators
- Leak-free performance – rigorously tested and field proven
- Wide-range availability and easy design implementation
- Excellent field serviceability – standard wrench disassembly

And it’s truly “universal” for compatibility worldwide:

- Utilizes standard Seal-Lok™ ORFS or EO fittings
- Suited for inch or metric tube, rubber or thermoplastic hose assemblies

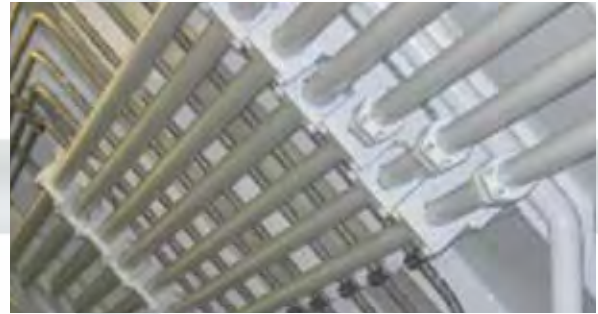


UPTC assembly consists of a standard Seal-Lok™ (ORFS) or EO bite-type fitting, factory-assembled UPTC nut with internal sealing and retaining elements, and hydraulic hose or rigid tube.



Complete Piping Solutions

providing Parflange® F37 technology – and its implementation



More than a superior component supplier, Parker is positioned globally as a system partner for non-welded piping systems. We have combined the innovative Parflange F37 non-welded piping system with a broad array of piping services in Parker's Complete Piping Solutions (CPS). For industries ranging from energy and mining to metals processing, testing systems and more, Parker CPS tailors piping solutions to maximize our customers' profitability.

Moving the technology forward
Parker is the worldwide leader in tube fitting and adapter technology. Numerous connector innovations and advancements are attributed to our engineering and customer-centric collaborations. Our Parflange® F37 system is the proven alternative to time-consuming and costly welding, and we continue to expand this product range to solve new customer challenges.

The complete services advantage
By coupling the best non-welded piping system with a complete engineered piping services package, CPS offers incomparable assurance, efficiency and value for our customers. Our Parflange F37 technology is supported with engineering consultation, design, state-of-the art piping fabrication facilities and on-site installation. Currently, Parker operates five CPS centers located worldwide with additional centers opening soon.

Parker's CPS team is on the jobsite providing the necessary expertise throughout the entire piping project.

Consultation and Design
The Parker CPS team of engineers offers expert consultation and design services.

During consultation, the customer's project requirements are reviewed with the CPS engineering team to determine the best-suited services. Technical and commercial requirements are reviewed. Line sizing, clamping requirements, routing, and environmental and safety concerns are considered during this early stage, as well as early commercial options.

Parker's CPS team provides a tailored proposal to match the customer's technical and commercial requirements whether the project is a line expansion, retrofit of existing piping



system or for OEM piping assemblies. This key collaborative planning provides a solid foundation for subsequent design work, as well as for fabrication of piping assemblies at a CPS center or on site.

As the project enters the design stage, Parker's engineer-to-engineer collaboration with the customer ensures that all technical requirements are met. Depending on the scope of work, piping assemblies are designed either on the jobsite or at the CPS center. Our piping designers are experts in on-site measurement/surveying, development or modification of detailed piping drawings, and steadfast review of customer technical specifications and applicable standards.

Prefabricated Assemblies and Installations

Parker's CPS team migrates the upfront piping engineering to factory prefabricated pipe assemblies with several installation options.



With state-of-the-art CNC large- and small-capacity bending equipment, as well as all complementary pipe end finishing equipment, the CPS team expertly manufactures prefabricated piping assemblies.

By using cold drawn seamless tubes, the non-welded Parflange F37 system is inherently cleaner than welded piping systems, providing the benefit of reduced system flushing time. The CPS center employs Parker filtration and condition monitoring technologies to bring piping cleanliness to documented customer requirements. On-site leak-proof testing services can also be specified.

Parker delivers fabricated pipe assemblies to the worksite. These pipe assemblies will be protected, labeled and ready for installation by the customer or Parker.

With the largest CNC cold bending capabilities in the industry, Parker's CPS team specializes in the factory fabrication of pre-bent piping assemblies. These assemblies reduce much of the on-site design and fabrication and allow for the most efficient installation on the jobsite. When the project does not allow for prefabrication of assemblies, Parker's CPS technicians dispatch these capabilities to the job.

Parker is fully engaged in the on-site installation of piping assemblies. A Parker CPS project manager leads the team of trained installers to maximize installation throughput and quality of installation work. Parker's lead role in overseeing the project from start to finish, and in ensuring that the installed piping system meets all requirements, instills a high degree of customer confidence.

The on-site piping installation service also enables quick reaction to unforeseen project obstacles or design changes. Costly project delays and downtime are dramatically minimized.

Parker provides best-in-class non-welded piping systems. Whether the scope of the project requires the complete redesign of a welded piping system or the fabrication and delivery of a pre-engineered non-welded piping assembly, Parker CPS will engineer a solution to maximize customer value.



Flare Flange



Retaining Ring



Light Duty

Robust technology is the foundation of Parker Complete Piping Solutions (CPS). Parflange F37 non-welded piping systems utilize standard SAE Code 61/62, ISO 6162 and ISO 6164 flange interfaces. Parflange F37 is fully complemented with Parker's fabrication equipment and a broad range of interconnect components, valves, clamps and seamless tubes.

Application Specific Piping Solutions

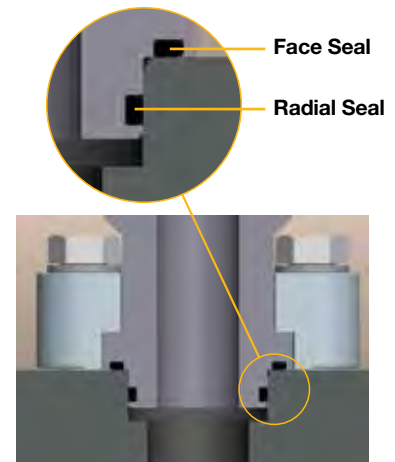
Some projects may require significant consultation and design services, while others may only need prefabricated pipe assemblies from a customer supplied print. Customers have the ability to choose from the breadth of services provided through the Parker CPS center – whether this is prefabricated piping assemblies delivered to the jobsite, on-site piping fabrication or a more turnkey approach including installation.

Parker Dual Seal Flange Adapters

for safer, more reliable flange connections in subsea applications



Dual Seal Flange Adapters use both a radial seal and face seal to achieve a leak-free port connection, eliminating traditional SAE flange connection problems.



Parker's Dual Seal Flange Adapters improve the reliability of high-vibration, high-shock hydraulic four-bolt connections in critical oil and gas applications.

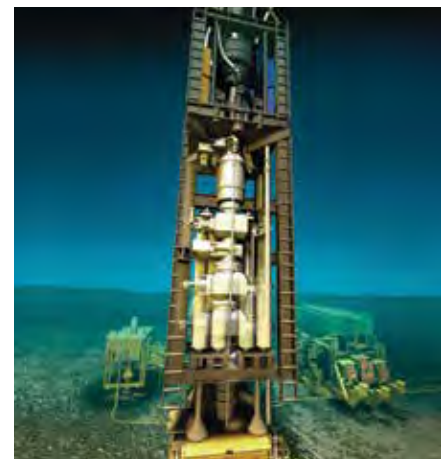
Dual Seal Flange Adapters incorporate both radial and face seal technologies, reducing the potential for system leakage and air or water ingress caused by side loading of traditional flange face seal connections.

This Parker innovation is offered as an alternative to traditional SAE Code 62 Flange connections for improved port retention, increased sealing capability and elimination of costly field replacement due to failure.

Key benefits include:

- Incorporates both radial and face sealing methods for improved sealing and port retention
- Available in standard Code 62 footprint sizes: ½", 1" and 1 ½"
- 7500 psi / 515 bar working pressure rating with 4:1 design factor
- NACE MR0175 Compliant
- SAE 316/316L stainless steel construction
- Heat Code Traceable
- Tested to 1 million impulse cycles for proven reliability
- Face seal design includes captive O-ring for superior retention
- SAE Code 62 bolt pattern enables use of standard flange hardware
- Seal-Lok™, Triple-Lok® and socket weld configurations offered

Illustrated above, the primary radial seal improves this adapter's pressure capabilities to 7500 psi while affording additional system integrity. The face seal provides resistance of external pressures introduced by the application environment.



Phastite® Pipe Connectors

deliver permanent, highly efficient non-welded piping solutions

TABLE
OF
CONTENTS



A breakthrough in pipe connection systems, Phastite connectors bring the proven technology of mechanically attached fittings to fluid and gas systems in a wide range of sizes.



Phastite non-welded piping connections provide permanent, leak-free connections quickly and efficiently. OEM or repair applications can be completed in less than three minutes as costly, time-consuming and hazardous welding can be eliminated. Parker has adapted the tube-sized Phastite technology to medium and heavy schedule nominal pipe size (NPS) range of 3/4" to 2".

Key benefits include:

- Reduces install time for piping systems in NPS sizes 1" and 1-1/2" (*complete selection of 3/4" to 2" available soon*)
- Reduces dye penetrant testing
- Reduces post welding RT/X-Ray expenditures
- Reduces requirements for special pipe sizing or beveling
- All 316/316L SS construction
- HCT – Heat Code Traceable
- 6000 psi / 415 bar pressure rating at 4:1 design factor
- Inherently safe and clean process
- No post-weld clean up or cool down period required
- No post-weld chemical cleaning or passivation required
- No hot works permits required
- Simple hydraulic assembly tool



PRODUCT SPOTLIGHT

The Latest From Parker, Your Fitting Authority.

TABLE
OF
CONTENTS

Mechanical Crimp Connection

for piping or tube systems saves the time and costs of welding



For today's piping or tube assemblies, Parker's Mechanical Crimp Connection (MCC) eliminates time-consuming, costly welding - and ensures reliable, leak-free performance.

MCC consists of a simple hydraulic assembly tool, specially designed bite ring and adapters. The bite ring attaches to the pipe or tube and secures the adapter. Internal seals in the MCC adapter ensure a leak-free connection and protect against ingress.

Assembly welding processes, from pre-cleaning to x-rays to post-cleaning, reduce valuable equipment uptime and require more labor. By comparison, MCC enables remarkably quick, easy

mechanical crimping of adapters to tube or piping. A 1" heavy-scheduled stainless steel pipe, for example, can take more than 30 minutes to weld and clean if all the steps are followed. An MCC assembly can be crimped within five minutes!

In the shop or the field, MCC also eliminates a key failure mode of welding: weld cracks, which can form while the weld is hot or while it is cooling, or due to fatigue or corrosion.

Key Features and Advantages

- **Eliminates time and costs of welding and post-weld processes**
- **Quicker, easier assembly promotes increased equipment uptime**
- **An inherently safe, clean process**
- **Simple hydraulic assembly tool**
- **Specially engineered bite ring for maximum retention**
- **Internal sealing components ensure leak-free performance**
- **Achieves "weld-less" NPS and tube connections from 1" to 2"**
- **Reduces requirements for special pipe sizing or beveling**
- **6000 psi/415 bar pressure rating at 4:1 design factor**

- **12L14 steel/ 316L stainless construction**
- **HTC - Heat Code Traceable**

Sizes and Configurations

Parker MCC achieves NPS and tube assemblies in the most common welded sizes, ranging from 1" to 2". Whether your system is transferring fluid at lower pressures or operating at high dynamic hydraulic pressures, MCC offers a working pressure capability up to 6000 psi for many applications.

MCC adapters are offered in steel (Chrome 6 Free plated) and 316 stainless steel. Multiple end configurations including code 61/62, male and female O-ring face seal, male and female 37° flare, and male and female NPT are available to ensure system compliance with SAE and/or ISO standards. MCC also offers full-range interchangeability with Parker Tube Fittings Division's extensive product lines, covering SAE and ISO specifications such as SAE J514, SAE J1453, and ISO 6162.

Ideal for a wide range of applications in industrial processing, construction, large mobile, oil and gas operations, and more, MCC gets equipment up and running sooner - and potentially much longer, thanks to Parker's decades of global leadership in Dry Technology. For all of the advantages that can improve your bottom line, contact your Parker representative about MCC now.

TH8-450 Production Crimper

for fast and accurate crimping

With Parker's horizontal crimper, anyone can make factory quality assemblies quickly, easily and cost effectively. An MCC assembly can be crimped within five minutes!





TABLE
OF
CONTENTS

VISUAL
INDEX














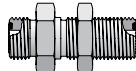
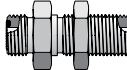
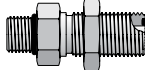






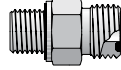


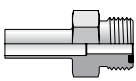
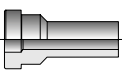
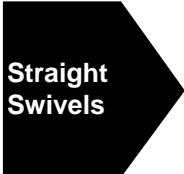
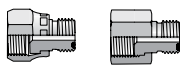

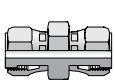
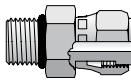
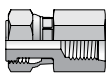
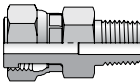
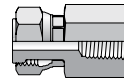
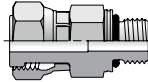
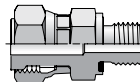


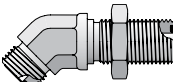
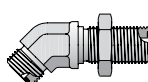
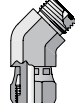
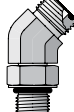
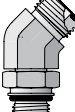
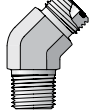
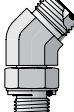
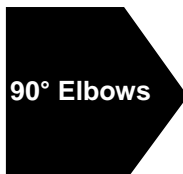

Seal-Lok™ O-Ring Face Seal Tube Fittings

A




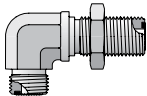
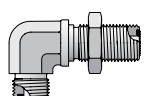
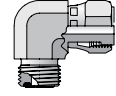
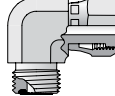
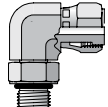
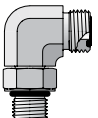
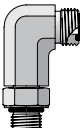

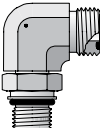
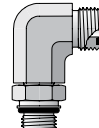
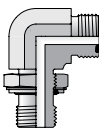
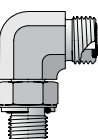
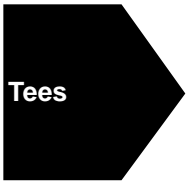
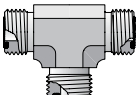
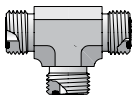
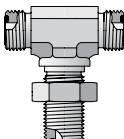
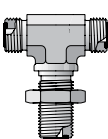
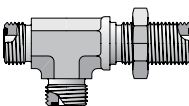
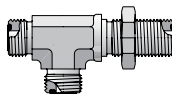
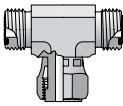
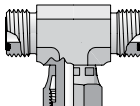
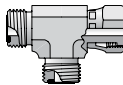
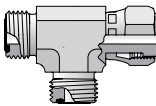
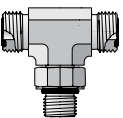
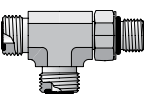
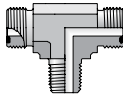
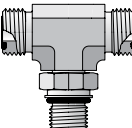
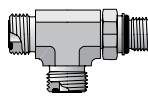
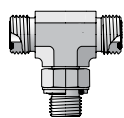
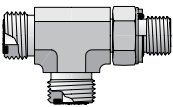
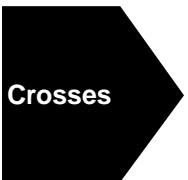
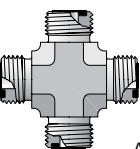







ENGINEERING YOUR SUCCESS.

TABLE OF CONTENTS

 <p>Nuts, Sleeves, Locknuts</p>	<p>BL Tube Nut</p>  <p>A9</p>	<p>BML Tube Nut - mm Hex</p>  <p>A9</p>	<p>TPLS (Metric) Parflange Sleeve</p>  <p>A9</p>	<p>TPL (Inch) Parflange Sleeve</p>  <p>A9</p>	<p>TL (Inch) Braze Reducer Sleeve</p>  <p>A10</p>
<p>TLS (Metric) Braze Reducer Sleeve</p>  <p>A10</p>	<p>SBR (Inch and Metric) Braze Ring</p>  <p>A11</p>	<p>WLN Bulkhead Locknut</p>  <p>A11</p>	<p>WLNML Blkhd Locknut - mm Hex</p>  <p>A11</p>	 <p>Straights</p>	<p>HLO Union</p>  <p>A12</p>
<p>HMLO Union - mm Hex</p>  <p>A12</p>	<p>WLO Bulkhead Union</p>  <p>A12</p>	<p>WMLO Bulkhead Union - mm Hex</p>  <p>A13</p>	<p>WF5OLO ORFS Blkhd / SAE-ORB</p>  <p>A13</p>	<p>F5OLO ORFS / SAE-ORB</p>  <p>A14</p>	<p>FF5OLO ORFS - Long / SAE-ORB</p>  <p>A14</p>
<p>FLO ORFS / NPTF</p>  <p>A14</p>	<p>GLO ORFS / NPTF</p>  <p>A15</p>	<p>F87OMLO ORFS / ISO 6149</p>  <p>A15</p>	<p>F82EDMLO ORFS / Metric-ED</p>  <p>A15</p>	<p>F42EDMLO ORFS / BSPP-ED</p>  <p>A15</p>	<p>LOHB3 ORFS / Braze Socket</p>  <p>A16</p>
<p>MMLOHB3 ORFS / Braze - mm Hex</p>  <p>A16</p>	<p>LOHT3 ORFS / Tube Weld</p>  <p>A16</p>	<p>TLW1 Butt Weld / Sleeve</p>  <p>A17</p>	 <p>Straight Swivels</p>	<p>TRLON Tube End Reducer</p>  <p>A17</p>	<p>LOHL6 Extender and Expander</p>  <p>A18</p>
<p>HL6 ORFS Swivel Union</p>  <p>A18</p>	<p>F65OL ORFS Swivel / SAE-ORB</p>  <p>A18</p>	<p>G65L ORFS Swivel / SAE-ORB</p>  <p>A18</p>	<p>F6L ORFS Swivel / NPTF</p>  <p>A18</p>	<p>G6L ORFS Swivel / NPTF</p>  <p>A18</p>	<p>F687OML ORFS Swivel / ISO 6149</p>  <p>A19</p>
<p>F682EDML ORFS Swivel / Metric-ED</p>  <p>A19</p>	<p>F642EDML ORFS Swivel / BSPP-ED</p>  <p>A19</p>	 <p>45° Elbows</p>	<p>WNLO Bulkhead Union</p>  <p>A19</p>	<p>WNMLO Bulkhead Union - mm Hex</p>  <p>A20</p>	<p>V6LO ORFS Swivel Elbow</p>  <p>A20</p>
<p>V5OLO ORFS / SAE-ORB</p>  <p>A20</p>	<p>V87OMLO ORFS / ISO 6149</p>  <p>A20</p>	<p>VLO ORFS / NPTF</p>  <p>A21</p>	<p>V4OMLO ORFS / BSPP-ORR</p>  <p>A21</p>	 <p>90° Elbows</p>	<p>ELO Union Elbow</p>  <p>A21</p>

A

TABLE OF CONTENTS

<p>EMLO Union Elbow - mm Hex</p>  <p>A21</p>	<p>WELO Bulkhead Union</p>  <p>A22</p>	<p>WEMLO Bulkhead Union - mm Hex</p>  <p>A22</p>	<p>C6LO ORFS Swivel Elbow</p>  <p>A23</p>	<p>C6MLO Swivel Elbow - mm Hex</p>  <p>A23</p>	<p>AOEL6 ORFS Swivel / SAE-ORB</p>  <p>A23</p>
<p>C5OLO ORFS / SAE-ORB</p>  <p>A23</p>	<p>CC5OLO ORFS / SAE-ORB - Long</p>  <p>A24</p>	<p>CLO ORFS / NPTF</p>  <p>A24</p>	<p>C87OMLO ORFS / ISO 6149</p>  <p>A24</p>	<p>CC87OMLO ORFS / ISO 6149 - Long</p>  <p>A25</p>	<p>C8OMLO ORFS / Metric-ORR</p>  <p>A25</p>
<p>C4OMLO ORFS / BSPP-ORR</p>  <p>A26</p>	<p>Tees</p> 	<p>JLO Union Tee</p>  <p>A26</p>	<p>JMLO Union Tee - mm Hex</p>  <p>A26</p>	<p>WJLO Bulkhead Branch</p>  <p>A26</p>	<p>WJMLO Blkhd Branch - mm Hex</p>  <p>A27</p>
<p>WJJLO Bulkhead Run</p>  <p>A27</p>	<p>WJJMLO Bulkhead Run - mm Hex</p>  <p>A28</p>	<p>S6LO ORFS Swivel Branch</p>  <p>A28</p>	<p>S6MLO Swivel Branch - mm Hex</p>  <p>A28</p>	<p>R6LO ORFS Swivel Run</p>  <p>A29</p>	<p>R6MLO Swivel Run - mm Hex</p>  <p>A29</p>
<p>S5OLO SAE-ORB Branch Tee</p>  <p>A29</p>	<p>R5OLO SAE-ORB Run Tee</p>  <p>A30</p>	<p>SLO NPTF Branch Tee</p>  <p>A30</p>	<p>S87OMLO ISO 6149 Branch Tee</p>  <p>A30</p>	<p>R87OMLO ISO 6149 Run Tee</p>  <p>A31</p>	<p>S4OMLO BSPP-ORR Branch Tee</p>  <p>A31</p>
<p>R4OMLO BSPP-ORR Run Tee</p>  <p>A32</p>	<p>Crosses</p> 	<p>KLO Union Cross</p>  <p>A32</p>	<p>Plugs, Caps and Bleed Adapters</p> 	<p>PNLO ORFS Plug</p>  <p>A33</p>	<p>PNMLO ORFS Plug - mm Hex</p>  <p>A33</p>
<p>FNL ORFS Cap</p>  <p>A33</p>	<p>FNML ORFS Cap - mm Hex</p>  <p>A33</p>	<p>UPTC Nut Assembly</p> 	<p>UPTC Nut Assembly</p>  <p>A34</p>		

Conversion Adapters (Shown in Section K)


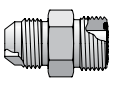
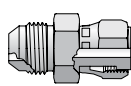
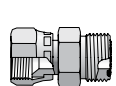
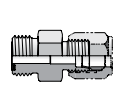
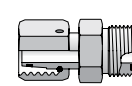
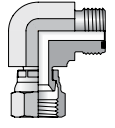

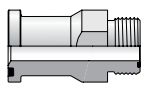
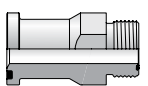
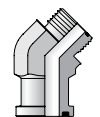
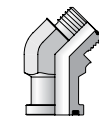
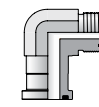
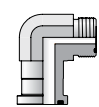

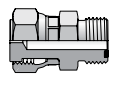
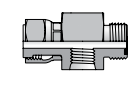
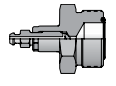
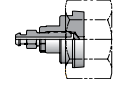

	XHLO 37° Flare / ORFS  K3	XHL6 37° Flare / ORFS Swivel  K3	LOHX6 ORFS / 37° Swivel  K3	BUHLO ORFS / Flareless (inch)  K4	LOHU86 Metric Swivel (EO)/ORFS  K4
	LOEX6 ORFS / 37° Swivel  K3				

TABLE OF CONTENTS


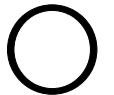
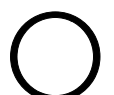
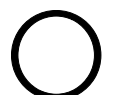
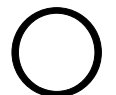
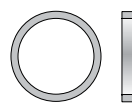
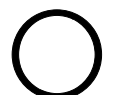
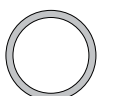

Flange Adapters (Shown in Section L)

	LOHQ1 Code 61 / ORFS  L12	LOHQ2 Code 62 / ORFS  L12	LOVQ1 Code 61 / ORFS  L30	LOVQ2 Code 62 / ORFS  L30	LOEQ1 Code 61 / ORFS  L31
	LOEQ2 Code 62 / ORFS  L31				

Diagnostic, Bleed Adapters & Screen Fittings (Shown in Section M)

	LOHL6 Orifice Orifice Swivel with Orifice / ORFS  M9	LOHL6G5TP Orifice Swivel / ORFS / SAE-ORB  M5	PNLOBA Bleed Screw / ORFS  M10	FNLBA Bleed Screw / SAE-ORB  M10	Screen Fittings  M12

O-Rings and Seals (Shown in Section N)

	ORFS O-Ring  N4	SAE O-Ring  N4	ISO 6149 O-Ring  N5	Metric O-Ring  N5	Metric Retaining Ring  N5
	BSPP O-Ring  N6	BSPP Retaining O-Ring  N6	EOlastic Seal Ring  N6		

Seal-Lok Introduction

The Seal-Lok fitting meets or exceeds the strict requirements of SAE J1453 and ISO 8434-3. It is an O-ring face seal type fitting that consists of a nut, a body, an O-ring and a sleeve. As shown in Fig. A2, the tube is flanged to 90° (or the tube may be brazed instead to a braze-type sleeve). When the fitting is assembled, it compresses an O-ring in the precision machined groove of the fitting body to form a leak tight seal.

Seal-Lok fittings are suitable for a wide range of tube wall thicknesses and are readily adaptable to inch or metric tubing and hose. (Please refer to Tables U3 and U4 located in the Appendix section for min./max. tube wall thickness for inch and metric tubing, respectively). Seal-Lok's leak-free design and rugged construction make it suitable for a wide range of applications where higher pressures, vibration and impulse are prevalent.

How Seal-Lok Fittings Work

The Seal-Lok fitting body face contains a high durometer trap seal to maximize retention in a precision machined groove also known as a Captive O-Ring Groove (CORG) referenced in Fig. A1. As the nut is tightened onto the fitting body, the trap seal is compressed between the body and flat face of the tube flange or braze sleeve to form a tight, positive seal (see Fig. A2).

As the two faces come in contact, further tightening of the nut produces a sharp rise in assembly torque. A solid pull of the wrench at this point, to recommended assembly torque, completes the assembly. The sharp torque rise gives a "solid feel" at assembly, minimizing the possibility of over tightening.

Because the sealing surfaces are flat and perpendicular to the assembly pull, they remain virtually free of distortion during assembly, giving Seal-Lok fittings practically unlimited remakability. The O-ring should be inspected at each disassembly and replaced when necessary. **See the O-Rings and Seals section for information on replacement ORFS O-rings.**

Because the tubing is a sealing surface, it must be smooth, free of any nicks, scratches, spiral tool marks, splits or weld beads. Seamless tube is recommended for Seal-Lok fittings for ease in flanging and bending. Certain types of harder tubes that are not fully annealed may not be suitable for flanging due to the potential for immediate or long-term cracking of the tube flange. For specific tube type and wall thickness recommendations, please see Table U3 in the Appendix Section.

Reference locations

Dynamic Pressure Ratings: Please refer to the last column of the part number tables located on the following pages of this section for the appropriate dynamic pressure ratings.

Recommended Tube Wall Thickness: Please refer to Table U3 located in the Appendix section.

Assembly and Installation: Please refer to Seal-Lok Assembly located within the Assembly/Installation section of this catalog.

Standard material specifications: Please refer to Table U1 located in the Appendix section.

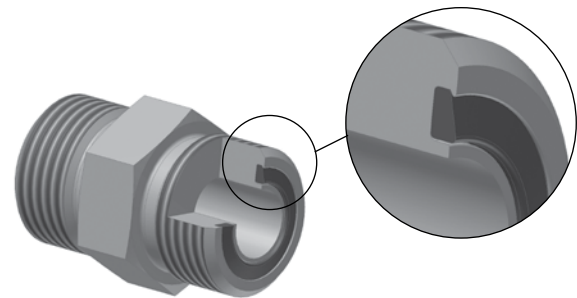


Fig. A1 — Captive O-ring Groove (CORG) Cutaway with Parker's trap seal

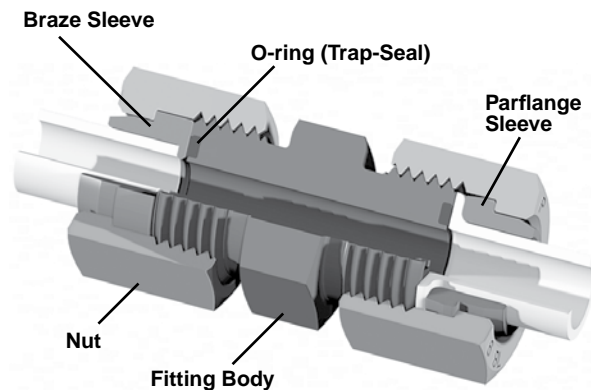


Fig. A2 — Seal-Lok Union cutaway with flanged and brazed assemblies

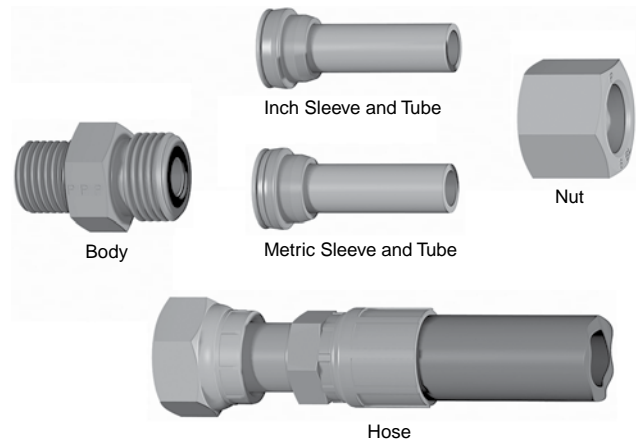


Fig. A3 — Seal-Lok Works with Inch or Metric Tube and Hose

Dimensions and pressures for reference only, subject to change.

Seal Material Selection: Please refer to Table T8 in the General Technical section of this catalog.

Tube Wall Thickness: Recommended min/max tube wall thicknesses for inch and metric Seal-Lok are provided in Tables U3 and U4 in the Appendix section, respectively. When using the braze method, all tube wall thicknesses can be used. For Parflange min/max tube wall thickness range, please refer to page R24 for tooling availability.



Fig. A4 — UPTC Seal-Lok is adaptable to a UPTC hydraulic or thermoplastic hose assembly. To be used with ET, EN, or EU hose ends.

TABLE OF CONTENTS

VISUAL INDEX

International Acceptance

The tube/hose end connection for metric Seal-Lok is the same as standard (inch) Seal-Lok. It consists of a body, a flange or braze sleeve, an O-ring and a nut. The difference is at the port end of the fitting. Instead of the SAE straight thread connection for example, it features a similar connection with metric threads per ISO 6149-2 or ISO 9974-1. Additionally, the fitting body, tube nut and locknut are manufactured with metric hexes or wrench flats for shaped fittings. The metric Seal-Lok fittings meet or exceed all requirements of ISO 8434-3.

To identify the metric sleeves used for metric tubing, there is a groove machined into the TPLS & TLS sleeves.

UPTC Pressure Ratings

Size	Pressure (psi)	Pressure (Bar)
-4	5800	400
-6	5000	345
-8	4250	293
-10	4000	276
-12	3125	216
-16	3125	216

Table A1 — UPTC Seal-Lok pressure ratings.

Universal Push-to-Connect (UPTC) Introduction

Traditionally, the fluid power industry has utilized threaded connectors to make a leak free connection. The speed of making connections is slow and the reliability of the connection is dependent on proper assembly procedures. Parker's UPTC connectors, on the other hand, rely on a mechanical retaining mechanism (other than threads) for holding power. No tools are required to assemble, and the reliability and speed of making connections with the UPTC design is greatly improved.

Design and Construction

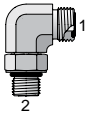
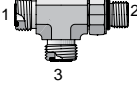
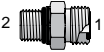
UPTC Seal-Lok consists of a base Seal-Lok ORFS fitting, a UPTC nut (including internal sealing and retaining elements) and a UPTC hose assembly, as shown in figure A4. The base ORFS fitting is a highly reliable and widely available off-the-shelf standard SAE J1453 adapter. The sealing O-Ring is supported by a pressure energized anti-extrusion ring that prevents O-Ring extrusion and ensures tight sealing even under high pressure. Once fully engaged, the retaining element is positively trapped between the male and UPTC nut. The dust seal keeps contamination out as well as giving a visual indication that the male stud has been inserted all the way. There is also a clear tactile indicator at the end of the push indicating a proper connection. Once a proper connection is made, the dust seal is covered by the UPTC nut. Proof of full engagement for easy inspection and quality control.

Once connected, the UPTC nut is permanently attached to the UPTC hose end similar to a traditional swivel nut. To disconnect, just use a wrench to unscrew the UPTC nut from the base adapter. Re-connect is possible by tightening the UPTC nut back to the base adapter, if the connection is not damaged. If the hose is damaged, it can be replaced by installing a readily available standard Seal-Lok ORFS hose assembly, or a new UPTC assembly.

Features

- Available in sizes 1/4", 3/8", 1/2", 5/8", 3/4", and 1"
- Utilizes all Seal-Lok adapters for a wide variety of configurations, as well as excellent field serviceability
- Meets or exceeds SAE 100R2 pressure ratings (see Table A1)
- Includes visual and tactile installation indicators
- Self-aligning nipple eliminates hose twist during assembly
- No special tooling required for disassembly
- Utilizes elastomeric seals, including Parker's patented Trap-Seal

How to order examples

Base Seal-Lok Part	UPTC Part #	Explanation
	8 C5OLO-S	8UR10 C5OLO-S Uniform size, UPTC subassembly on 1st end only
	8-10 C5OLO-S	8-10UR10 C5OLO-S Jump size, UPTC subassembly on 1st end only
	8 R5OLO-S	8UR101 R5OLO-S Uniform size, UPTC subassembly on 1st and 3rd end
	8-10-8 R5OLO-S	8-10-8UR001 R5OLO-S Jump size, UPTC subassembly on 3rd end only
	8-10-8 R5OLO-S	8-10-8UR100 R5OLO-S Jump size, UPTC subassembly on 1st end only
	8M14F87OMLOS	8M14UR10F87OMLOS Compressed nomenclature, UPTC subassembly on 1st end only

A

TABLE OF CONTENTS

VISUAL INDEX

The Parker Advantage

Trap Seal™: The patented trapezoidal seal of the Seal-Lok tube end allows for maximum o-ring retention in the CORG groove. This advantage over the competition increases the productivity of assembly as well as offers the maximum assurance for a leak free connection. Ultimately, operational and maintenance costs can be avoided.

Resistance to over-torque: The minimum requirement for a Seal-Lok connection is to withstand 200% torque above the rated value. This reduces the frequency of metal distortion and the potential of leaks. Seal-Lok reduces production assembly and maintenance costs by its resistance to over-torque.

Zero clearance: The flat face of Seal-Lok allows for easy and fast drop-in installation. This reduces rework costs from a design and assembly perspective. Maintenance cost can be avoided due to the time savings of disassembly and assembly.

High pressure rating: Seal-Lok offers a high pressure rating which can be used in a wide range of applications. This provides the opportunity to standardize across multiple product lines, saving procurement and inventory costs.

Superior Plating: Superior plating gives Parker steel tube fittings unmatched protection against red rust. In neutral salt spray test per ASTM B117, Parker Triple-Lok fittings substantially exceeded the SAE requirement of 96 hours to red rust.

Robust Port Stud: The adjustable port stud is manufactured with a longer locknut designed to cover the uppermost threads completely. Since the backup washer is never exposed to the upper threads, it cannot be damaged during assembly. During assembly, exposed upper threads, as common with fittings from other fitting manufacturers, can lead to a deformed backup washer that can pinch the o-ring and create an o-ring extrusion gap that has the potential to leak. The longer locknut also provides a greater grip area for the wrench.

Unlimited reusability: When a Seal-Lok connection is completely assembled and disassembled, very little metal is distorting in the connection. So, Seal-Lok allows for unlimited reusability in the field, reducing the component replacement and maintenance costs of the connection.

Universal Push to Connect (UPTC): Parker's UPTC offers a quick and easy way to assemble Seal-Lok configurations. UPTC is ideal for hard to reach applications or to speed up the process of assembly. The tangible operational and maintenance costs associated with each connection made will be reduced when using UPTC.

Dimensions and pressures for reference only, subject to change.



Seal-Lok O-Ring Face Seal Tube Ends

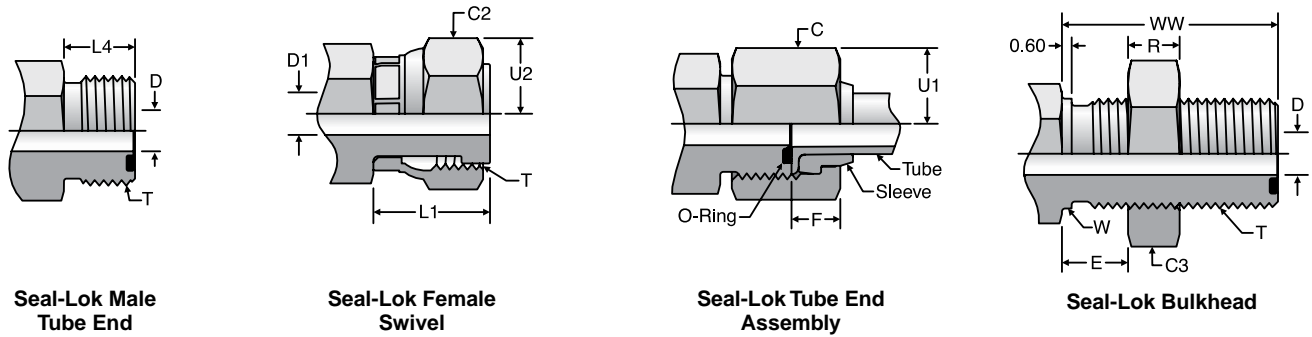


TABLE OF CONTENTS

VISUAL INDEX

SAE Dash	Tube O.D.	T	Thread						Nominal Drill Tube End	Nominal Drill Swivel End	Max Bulkhead Thickness	Tube Nut Assembled Allowance	Swivel Turn Back	Male Turn Back	Bulkhead			Across Corners	
			UN/UNF	C		C2		C3							Locknut Thickness	Pilot Dia	Length	Tube Nut Hex	Swivel Nut Hex
Size	(in.) (mm)		(in.) (mm)	(in.) (mm)	(in.) (mm)	(in.) (mm)	(in.) (mm)	(in.) (mm)	(in.) (mm)	(in.) (mm)	(in.) (mm)	(in.) (mm)	(in.) (mm)	(in.) (mm)	(in.) (mm)	(in.) (mm)	(in.) (mm)	(in.) (mm)	
4	1/4 6	9/16-18	11/16 17	11/16 17	13/16 22	11/16 17	13/16 22	0.177	0.157	0.55	0.270	0.642	0.394	0.27	0.563	1.24	0.80	0.80	
6	3/8 8/10	11/16-16	13/16 22	13/16 22	1 27	13/16 22	1 27	0.256	0.256	0.55	0.340	0.715	0.441	0.32	0.688	1.34	0.94	0.94	
8	1/2 12	13/16-16	15/16 24	15/16 24	1 1/8 30	15/16 24	1 1/8 30	0.374	0.354	0.55	0.400	0.865	0.512	0.35	0.813	1.44	1.08	1.08	
10	5/8 14/15/16	1-14	1 1/8 30	1 1/8 30	1 5/16 36	1 1/8 30	1 5/16 36	0.492	0.453	0.55	0.455	0.980	0.618	0.41	1.000	1.60	1.30	1.30	
12	3/4 18/20	1 3/16-12	1 3/8 36	1 3/8 36	1 1/2 41	1 3/8 36	1 1/2 41	0.610	0.551	0.55	0.510	1.110	0.677	0.41	1.188	1.64	1.58	1.58	
14	7/8 —	1 5/16-12	1 1/2 41	1 1/2 41	1 5/8 46	1 1/2 41	1 5/8 46	0.709	0.709	0.55	0.512	1.145	0.697	0.41	1.313	1.66	1.74	1.74	
16	1 22/25	1 7/16-12	1 5/8 41	1 5/8 41	1 3/4 46	1 5/8 41	1 3/4 46	0.807	0.787	0.55	0.596	1.190	0.697	0.41	1.438	1.66	1.88	1.88	
20	1 1/4 28/30/32	1 11/16-12	1 7/8 50	1 7/8 50	2 50	1 7/8 50	2 50	1.024	1.024	0.55	0.566	1.251	0.697	0.41	1.688	1.66	2.16	2.16	
24	1 1/2 35/38	2-12	2 1/4 60	2 1/4 60	2 3/8 60	2 1/4 60	2 3/8 60	1.260	1.260	0.55	0.545	1.330	0.697	0.41	2.000	1.66	2.60	2.60	
32	2 42/50	2 1/2-12	2 7/8 60	2 7/8 60	2 3/4 60	2 7/8 60	2 3/4 60	1.772	1.732	0.50	0.606	1.690	0.874	0.54	2.500	1.83	3.32	3.32	

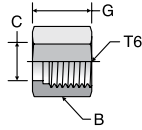
- 1) D and D1 nominal may vary from the values shown in the chart by 0.004 to 0.008. Also, D for -4 metric based Seal-Lok may be D.197 (5 mm) to satisfy ISO 8434-3 (1994 edition). Contact the Tube Fittings Division if there are any questions.
- 2) Recommended clearance hole = W + 0.015.
- 3) See page N4 for ORFS O-rings.
- 4) Note: For port and stud end dimensions reference section F: Pipe Fittings and Port Adapters.

Dimensions and pressures for reference only, subject to change.



BL
Tube Nut
ORFS

SAE 520110



TUBE FITTING PART #	END SIZE (in.)	T6 UNF/UNF-2B	B HEX (in.)	C (in.)	G (in.)	Material	
						-S	-SS
4 BL	1/4	9/16 - 18	11/16	0.410	0.59	•	•
5 BL	5/16	5/8 - 18	3/4	0.470	0.63	•	•
6 BL	3/8	11/16 - 18	13/16	0.530	0.67	•	•
8 BL	1/2	13/16 - 16	15/16	0.650	0.79	•	•
10 BL	5/8	1 - 14	1 1/8	0.830	0.94	•	•
12 BL	3/4	1 3/16 - 12	1 3/8	0.950	1.04	•	•
12-14 BL	7/8	1 3/16 - 12	1 3/8	0.990	1.20	•	•
14 BL	7/8	1 5/16 - 12	1 1/2	1.075	1.04	•	•
16 BL	1	1 7/16 - 12	1 5/8	1.150	1.08	•	•
20 BL	1 1/4	1 11/16 - 12	1 7/8	1.420	1.08	•	•
24 BL	1 1/2	2 - 12	2 1/4	1.730	1.08	•	•
32 BL*	2	2 1/2 - 12	2 7/8	2.220	1.30	•	•

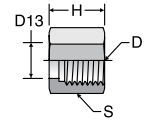
* Sizes 14 and 32 are not included in SAE J1453.

** These tube nuts should not be exposed to annealing temperatures, such as furnace brazing. Contact the Tube Fittings Division for information on special nuts.

• Stainless steel tube nuts are prelubricated for ease of assembly.

BML
Tube Nut – mm Hex
ORFS

ISO 8434-3 NA
SAE 52M0110A



TUBE FITTING PART #	END SIZE		D THREAD UN/UNF-2B	D13 DRILL (mm)	H (mm)	S HEX (mm)	Material S
	(mm)	(in.)					
4BML	6	1/4	9/16 - 18	10.50	15.0	17	•
6BML	8,10	3/8	11/16 - 16	13.55	17.5	22	•
8BML	12	1/2	13/16 - 16	16.60	20.0	24	•
10BML	14,15,16	5/8	1 - 14	21.10	24.0	30	•
12BML	18,20	3/4	1 3/16 - 12	24.15	26.5	36	•
16BML	22,25	1	1 7/16 - 12	29.10	27.5	41	•
20BML	28,30,32	1 1/4	1 11/16 - 12	36.00	27.5	50	•
24BML	35,38	1 1/2	2 - 12	44.00	27.5	60	•

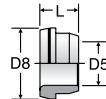
A

TABLE OF CONTENTS

VISUAL INDEX

TPLS (Metric)

Parflange Sleeve for
Metric Tubing
ORFS Mechanically
Attachable Sleeve

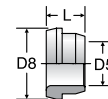


TUBE FITTING PART #	USED WITH FITTING SIZE	D5 END SIZE (mm)	D8 DIA (mm)	L (mm)	Material
					S
TPLS6	-4	6	12.75	7.5	•
TPLS8	-6	8	15.75	8.5	•
TPLS10	-6	10	15.75	8.5	•
TPLS12	-8	12	18.90	10.5	•
TPLS14	-10	14	23.50	10.5	•
TPLS15	-10	15	23.50	10.5	•
TPLS16	-10	16	23.50	10.5	•
TPLS18	-12	18	27.80	12.0	•
TPLS20	-12	20	27.80	12.0	•
TPLS25	-16	25	34.00	13.5	•
TPLS30	-20	30	40.50	13.0	•
TPLS32	-20	32	40.50	13.0	•
TPLS35	-24	35	48.50	12.5	•
TPLS38	-24	38	48.50	12.5	•

• Must be mechanically attached using Parflange system.
• Additional -S not required, TPLS6 is complete part number.

TPL (Inch)

Parflange Sleeve
for Inch Tubing
ORFS Mechanically
Attachable Sleeve



TUBE FITTING PART #	D5 END SIZE (in.)	D8 DIA (in.)	L (in.)	Material
				-S
4 TPL	1/4	0.50	0.30	•
6 TPL	3/8	0.62	0.34	•
8 TPL	1/2	0.74	0.42	•
10 TPL	5/8	0.92	0.42	•
12 TPL	3/4	1.09	0.47	•
16 TPL	1	1.34	0.53	•
20 TPL	1 1/4	1.59	0.51	•
24 TPL	1 1/2	1.91	0.49	•
32 TPL	2	2.39	0.54	•

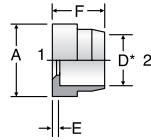
• Must be mechanically attached using Parflange system.

Dimensions and pressures for reference only, subject to change.

TL (Inch)

Braze Sleeve for Inch Tubing
ORFS Silver Braze Sleeve Reducer

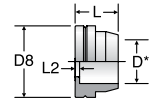
SAE 520115



TLS (Metric)

Braze Sleeve for Metric Tubing
ORFS Silver Braze Sleeve

ISO 8434-3 BRSL
SAE 5201M15



TUBE FITTING PART #	END SIZE		A (in.)	D* (in.)	E (in.)	F (in.)	Material	
	1 (in.)	2 (in.)					-S	-SS
4 TL	1/4		0.50	0.26	0.04	0.37	•	•
6 TL	3/8		0.62	0.38	0.04	0.37	•	•
6-4 TL	3/8	1/4	0.62	0.26	0.08	0.41	•	•
8 TL	1/2		0.75	0.51	0.04	0.37	•	•
8-4 TL	1/2	1/4	0.75	0.26	0.14	0.47	•	•
8-6 TL	1/2	3/8	0.75	0.38	0.14	0.47	•	•
10 TL	5/8		0.92	0.63	0.06	0.41	•	•
10-4 TL	5/8	1/4	0.92	0.26	0.20	0.53	•	•
10-6 TL	5/8	3/8	0.92	0.38	0.20	0.53	•	•
10-8 TL	5/8	1/2	0.92	0.51	0.20	0.53	•	•
12 TL	3/4		1.10	0.76	0.06	0.55	•	•
12-4 TL	3/4	1/4	1.10	0.26	0.24	0.57	•	•
12-6 TL	3/4	3/8	1.10	0.38	0.24	0.57	•	•
12-8 TL	3/4	1/2	1.10	0.51	0.24	0.57	•	•
12-10 TL	3/4	5/8	1.10	0.63	0.22	0.57	•	•
12-14 TL**	3/4	7/8	1.10	0.88	0.06	0.65	•	•
14 TL***	7/8		1.22	0.88	0.06	0.55	•	•
16 TL	1		1.35	1.01	0.06	0.61	•	•
16-8 TL	1	1/2	1.35	0.51	0.28	0.61	•	•
16-10 TL	1	5/8	1.35	0.63	0.26	0.61	•	•
16-12 TL	1	3/4	1.35	0.76	0.18	0.67	•	•
16-14 TL	1	7/8	1.35	0.88	0.18	0.67	•	•
20 TL	1 1/4		1.60	1.26	0.06	0.61	•	•
20-12 TL	1 1/4	3/4	1.60	0.76	0.28	0.77	•	•
20-16 TL	1 1/4	1	1.60	1.01	0.28	0.83	•	•
24 TL	1 1/2		1.91	1.51	0.06	0.61	•	•
24-16 TL	1 1/2	1	1.91	1.01	0.28	0.83	•	•
24-20 TL	1 1/2	1 1/4	1.91	1.26	0.28	0.83	•	•
32 TL***	2		2.41	2.01	0.06	0.65	•	•

Unplated part, oil dipped for corrosion protection.

* D is for silver brazing.

** 12-14 TL must be assembled with 12-14 BL.

*** Sizes 14 and 32 are not included in SAE J1453.

• Uses SBR silver braze rings

TUBE FITTING PART #	USED WITH FITTING SIZE	D* END SIZE (mm)	D8 DIA (mm)	L (mm)	L2 (mm)	Material	
						S	SS
TLS6	-4	6	12.8	9.5	1.0	•	•
TLS8	-6	8	15.8	9.5	1.0	•	•
TLS10	-6	10	15.8	9.5	1.0	•	•
TLS12	-8	12	18.9	9.5	1.0	•	•
TLS16	-10	16	23.5	10.5	1.5	•	•
TLS20	-12	20	27.9	14.0	1.5	•	•
TLS25	-16	25	34.2	15.5	1.5	•	•
TLS30	-20	30	40.6	15.5	1.5	•	•
TLS38	-24	38	48.5	15.5	1.5	•	•

Unplated part, oil dipped for corrosion protection.

* D is for silver brazing.

• Uses SBR (metric) silver braze rings

• Stainless steel part number example: TLSS10

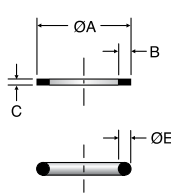
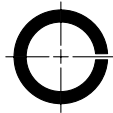
TABLE OF CONTENTS

VISUAL INDEX

Dimensions and pressures for reference only, subject to change.

SBR (Inch)

Silver Braze Ring for Inch Tubing

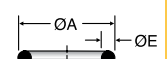
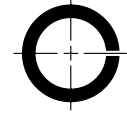


TUBE FITTING PART #	END SIZE (in.)	A DIA (in.)	B (in.)	C (in.)	E (in.)
4 SBR	1/4	0.260	—	—	0.05
6 SBR	3/8	0.390	0.07	0.03	—
8 SBR	1/2	0.515	0.07	0.03	—
10 SBR	5/8	0.640	0.07	0.03	—
12 SBR	3/4	0.765	0.08	0.04	—
14 SBR	7/8	0.890	—	—	0.06
16 SBR	1	1.015	0.08	0.04	—
20 SBR	1 1/4	1.265	0.08	0.04	—
24 SBR	1 1/2	1.515	0.08	0.04	—
32 SBR	2	2.015	—	—	0.09

SBR recommended for steel or copper tubing. -S not required.
SBR-SS recommended for stainless tubing, but can be used on steel tubing.
Contact the Tube Fittings Division for braze rings used in marine or special applications.

SBR (Metric)

Silver Braze Ring for Metric Tubing



TUBE FITTING PART #	END SIZE (mm)	A DIA (mm)	E (mm)
SBR 6mm	6	6.4	1.2
SBR 8mm	8	8.4	1.2
SBR 10mm	10	10.4	1.2
SBR 12mm	12	12.4	1.2
SBR 16mm	16	16.4	1.2
SBR 20mm	20	20.4	1.6
SBR 25mm	25	25.4	1.6
SBR 30mm	30	30.4	1.6
SBR 38mm	38	38.4	1.6

SBR recommended for steel or copper tubing.
SBR-SS recommended for stainless tubing, but can be used on steel tubing.
Contact the Tube Fittings Division for braze rings used in marine or special applications.

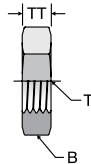
A

TABLE OF CONTENTS
VISUAL INDEX

WLNL

Bulkhead Locknut

SAE 520118



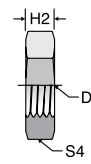
TUBE FITTING PART #	END SIZE (in.)	T TUBE END UN/UNF-2A	B HEX (in.)	TT (in.)	Material
					-S
4 WLNL	1/4	9/16 - 18	13/16	0.27	•
6 WLNL	3/8	11/16 - 16	1	0.31	•
8 WLNL	1/2	13/16 - 16	1 1/8	0.35	•
10 WLNL	5/8	1 - 14	1 5/16	0.41	•
12 WLNL	3/4	1 3/16 - 12	1 1/2	0.41	•
14 WLNL*	7/8	1 5/16 - 12	1 5/8	0.41	•
16 WLNL	1	1 7/16 - 12	1 3/4	0.41	•
20 WLNL	1 1/4	1 11/16 - 12	2	0.41	•
24 WLNL	1 1/2	2 - 12	2 3/8	0.41	•

* Size 14 is not included in SAE J1453.

WLNML

Bulkhead Locknut – mm Hex

ISO 8434-3 BHLN
SAE 52M0118



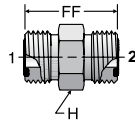
TUBE FITTING PART #	END SIZE		D TUBE END UN/UNF-2B	H2 (mm)	S4 HEX (mm)	Material
	(mm)	(in.)				S
4WLNML	6	1/4	9/16 - 18	7.0	22	•
6WLNML	8,10	3/8	11/16 - 16	8.0	27	•
8WLNML	12	1/2	13/16 - 16	9.0	30	•
10WLNML	14,15,16	5/8	1 - 14	10.5	36	•
12WLNML	18,20	3/4	1 3/16 - 12	10.5	41	•
16WLNML	22,25	1	1 7/16 - 12	10.5	46	•
20WLNML	28,30,32	1 1/4	1 11/16 - 12	10.5	50	•
24WLNML	35,38	1 1/2	2 - 12	10.5	60	•

Dimensions and pressures for reference only, subject to change.

HLO

Union
ORFS / ORFS

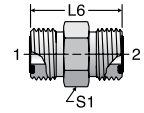
SAE 520101



HMLO

Union – mm Hex
ORFS / ORFS

ISO 8434-3 S
SAE 52M0101



TUBE FITTING PART #	END SIZE		FF (in.)	H HEX (in.)	Dynamic Pressure (x 1,000 PSI)	
	1 (in.)	2 (in.)			-S	-SS
	4 HLO	1/4			1/4	1.08
6 HLO	3/8	3/8	1.22	3/4	9.2	9.2
6-4 HLO	3/8	1/4	1.18	3/4	9.2	9.2
8 HLO	1/2	1/2	1.40	7/8	9.2	9.2
8-6 HLO	1/2	3/8	1.32	7/8	9.2	9.2
10 HLO	5/8	5/8	1.67	1 1/16	6.0	6.0
10-8 HLO	5/8	1/2	1.57	1 1/16	6.0	6.0
12 HLO	3/4	3/4	1.85	1 1/4	6.0	6.0
12-8 HLO	3/4	1/2	1.69	1 1/4	6.0	6.0
12-10 HLO	3/4	5/8	1.79	1 1/4	6.0	6.0
16 HLO	1	1	1.95	1 1/2	6.0	6.0
16-12 HLO	1	3/4	1.93	1 1/2	6.0	6.0
20 HLO	1 1/4	1 1/4	2.03	1 3/4	6.0	6.0
20-16 HLO	1 1/4	1	2.03	1 3/4	6.0	6.0
24 HLO	1 1/2	1 1/2	2.09	2 1/8	5.0	5.0
32 HLO*	2	2	2.48	2 3/4	3.0	3.0

* Size 32 is not included in SAE J1453.

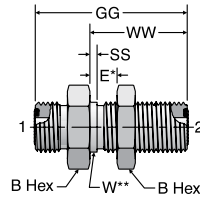
TUBE FITTING PART #	END SIZE 1 & 2		L6 (mm)	S1 HEX (mm)	Dynamic Pressure (x 1,000 PSI)	
	(mm)	(in.)			S	SS
	4HMLO	6			1/4	27.5
6HMLO	8,10	3/8	31.0	19	9.2	9.2
8HMLO	12	1/2	35.5	22	9.2	9.2
10HMLO	14,15,16	5/8	42.5	27	6.0	6.0
12HMLO	18,20	3/4	47.0	32	6.0	6.0
16HMLO	22,25	1	49.5	41	6.0	6.0
20HMLO	28,30,32	1 1/4	51.5	46	6.0	6.0
24HMLO	35,38	1 1/2	53.0	55	5.0	5.0

TABLE OF CONTENTS
VISUAL INDEX

WLO

Bulkhead Union
ORFS / ORFS

SAE 520601
WLO-WLNL Body with Locknut
(See page A11 for WLNL)



TUBE FITTING PART #	END SIZE (in.)	B HEX (in.)	E MAX (in.)	GG (in.)	SS	W DIA (in.)	WW (in.)	Dynamic Pressure (x 1,000 PSI)	
								-S	-SS
								4 WLO	1/4
6 WLO	3/8	1	0.55	2.09	0.06	0.69	1.34	9.2	9.2
8 WLO	1/2	1 1/8	0.55	2.30	0.06	0.81	1.44	9.2	9.2
10 WLO	5/8	1 5/16	0.55	2.62	0.06	1.00	1.59	6.0	6.0
12 WLO	3/4	1 1/2	0.55	2.72	0.06	1.19	1.63	6.0	6.0
16 WLO	1	1 3/4	0.55	2.76	0.06	1.44	1.65	6.0	6.0
20 WLO	1 1/4	2	0.55	2.76	0.06	1.69	1.65	6.0	6.0
24 WLO	1 1/2	2 3/8	0.55	2.76	0.06	2.00	1.65	5.0	5.0

** W – Bulkhead pilot diameter. Recommended clearance hole is W + 0.015".

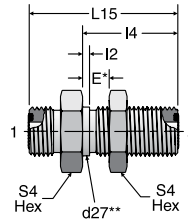
Dimensions and pressures for reference only, subject to change.



WMLO

Bulkhead Union – mm Hex
ORFS / ORFS

ISO 8434-3 BHS
SAE 52M0601
WMLO-WLNML - Body with Locknut
(See page A11 for WLNML)



A

TABLE OF CONTENTS

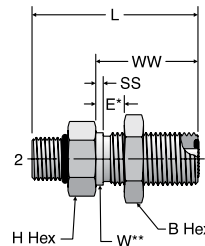
VISUAL INDEX

TUBE FITTING PART #	END SIZE		d27** (mm)	E (mm)	I4 (mm)	I2 (mm)	L15 (mm)	S4 HEX (mm)	Dynamic Pressure (x 1,000 PSI)	
	1 & 2								S	SS
	(mm)	(in.)								
4WMLO	6	1/4	14.3	14	31.5	1.5	48.0	22	9.2	9.2
6WMLO	8,10	3/8	17.5	14	34.0	1.5	53.0	27	9.2	9.2
8WMLO	12	1/2	20.6	14	36.5	1.5	58.5	30	9.2	9.2
10WMLO	14,15,16	5/8	25.4	14	40.5	1.5	66.5	36	6.0	6.0
12WMLO	18,20	3/4	30.2	14	41.5	1.5	69.0	41	6.0	6.0
16WMLO	22,25	1	36.5	14	42.0	1.5	70.0	46	6.0	6.0
20WMLO	28,30,32	1 1/4	42.9	14	42.0	1.5	70.0	50	6.0	6.0
24WMLO	35,38	1 1/2	50.8	14	42.0	1.5	70.0	60	5.0	5.0

* E – Maximum bulkhead thickness.
**d27 – Bulkhead pilot diameter. Recommended clearance hole is d27 + 0.4 mm

WF5OLO

Straight Thread Bulkhead Connector
ORFS / SAE-ORB
WF5OLO-WLNL - Body with Locknut
(See page A11 for WLNL)



TUBE FITTING PART #	END SIZE		B HEX (in.)	E MAX (in.)	H HEX (in.)	L (in.)	SS (in.)	W DIA (in.)	WW (in.)	Dynamic Pressure (x 1,000 PSI)	
	1 (in.)	2 UN/UNF-2A								-S	-SS
	4 WF5OLO	1/4									
6 WF5OLO	3/8	9/16 - 18	1	0.55	1	2.31	0.06	0.69	1.34	9.2	9.2
8 WF5OLO	1/2	3/4 - 16	1 1/8	0.55	1 1/8	2.60	0.06	0.81	1.44	9.2	9.2
10 WF5OLO	5/8	7/8 - 14	1 5/16	0.55	1 5/16	2.69	0.06	1.00	1.60	6.0	6.0
12 WF5OLO	3/4	1 1/16 - 12	1 1/2	0.55	1 1/2	2.89	0.06	1.19	1.64	6.0	6.0
16 WF5OLO	1	1 5/16 - 12	1 3/4	0.55	1 3/4	2.95	0.20	1.58	1.66	6.0	6.0

* E – Maximum bulkhead thickness.
** W – Bulkhead pilot diameter. Recommended clearance hole is W + 0.015".

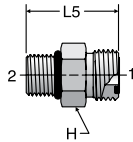
Dimensions and pressures for reference only, subject to change.



F5OLO

Straight Thread Connector
ORFS / SAE-ORB

SAE 520120

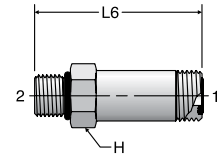


TUBE FITTING PART #	END SIZE		H HEX (in.)	L5 (in.)	Dynamic Pressure (x 1,000 PSI)	
	1 (in.)	2 UN/UNF-2A			-S	-SS
4 F5OLO	1/4	7/16 - 20	5/8	1.13	9.2	9.2
4-5 F5OLO	1/4	1/2 - 20	5/8	1.16	9.2	9.2
4-6 F5OLO	1/4	9/16 - 18	3/4	1.20	9.2	9.2
4-8 F5OLO	1/4	3/4 - 16	7/8	1.32	9.2	9.2
6 F5OLO	3/8	9/16 - 18	3/4	1.26	9.2	9.2
6-4 F5OLO	3/8	7/16 - 20	3/4	1.34	9.2	9.2
6-5 F5OLO	3/8	1/2 - 20	3/4	1.22	9.2	9.2
6-8 F5OLO	3/8	3/4 - 16	7/8	1.38	9.2	9.2
6-10 F5OLO	3/8	7/8 - 14	1	1.52	9.2	9.2
8-12 F5OLO	3/8	1 1/16 - 12	1 1/4	1.67	9.2	9.2
8 F5OLO	1/2	3/4 - 16	7/8	1.44	9.2	9.2
8-4 F5OLO	1/2	7/16 - 20	7/8	1.44	9.2	9.2
8-6 F5OLO	1/2	9/16 - 18	7/8	1.48	6.0	6.0
8-10 F5OLO	1/2	7/8 - 14	1	1.59	6.0	6.0
8-12 F5OLO	1/2	1 1/16 - 12	1 1/4	1.75	6.0	6.0
8-16 F5OLO	1/2	1 5/16 - 12	1 1/2	1.79	6.0	6.0
10 F5OLO	5/8	7/8 - 14	1 1/16	1.69	6.0	6.0
10-6 F5OLO	5/8	9/16 - 18	1 1/16	1.63	6.0	6.0
10-8 F5OLO	5/8	3/4 - 16	1 1/16	1.77	6.0	6.0
10-12 F5OLO	5/8	1 1/16 - 12	1 1/4	1.85	6.0	6.0
10-16 F5OLO	5/8	1 5/16 - 12	1 1/2	1.89	6.0	6.0
12 F5OLO	3/4	1 1/16 - 12	1 1/4	1.91	6.0	6.0
12-6 F5OLO	3/4	9/16 - 16	1 1/4	1.77	6.0	6.0
12-8 F5OLO	3/4	3/4 - 16	1 1/4	1.91	6.0	6.0
12-10 F5OLO	3/4	7/8 - 14	1 1/4	1.99	6.0	6.0
12-16 F5OLO	3/4	1 5/16 - 12	1 1/2	1.95	6.0	6.0
14 F5OLO	7/8	1 3/16 - 12	1 3/8	1.91	6.0	6.0
16 F5OLO	1	1 5/16 - 12	1 1/2	1.97	6.0	6.0
16-8 F5OLO	1	3/4 - 16	1 1/2	1.96	6.0	6.0
16-10 F5OLO	1	7/8 - 14	1 1/2	2.05	6.0	6.0
16-12 F5OLO	1	1 1/16 - 12	1 1/2	2.15	6.0	6.0
16-20 F5OLO	1	1 5/8 - 12	1 7/8	2.07	6.0	6.0
16-24 F5OLO	1	1 7/8 - 12	2 1/8	2.13	6.0	6.0
20 F5OLO	1 1/4	1 5/8 - 12	1 7/8	2.07	6.0	6.0
20-16 F5OLO	1 1/4	1 5/16 - 12	1 7/8	2.28	6.0	6.0
20-24 F5OLO	1 1/4	1 7/8 - 12	2 1/8	2.13	5.0	5.0
24 F5OLO	1 1/2	1 7/8 - 12	2 1/8	2.13	5.0	5.0
24-20 F5OLO	1 1/2	1 5/8 - 12	2 1/8	2.34	5.0	5.0
32 F5OLO*	2	2 1/2 - 12	2 3/4	2.32	3.0	3.0

FF5OLO

Long Straight Thread Connector
ORFS-Long / SAE-ORB

SAE 521720 (previously 520122)



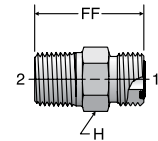
TUBE FITTING PART #	END SIZE		H HEX (in.)	L6 (in.)	Dynamic Pressure (x 1,000 PSI)	
	1 (in.)	2 UN/UNF-2A			-S	-SS
4 FF5OLO	1/4	7/16 - 20	5/8	2.07	9.2	9.2
6 FF5OLO	3/8	9/16 - 18	3/4	2.27	9.2	9.2
6-4 FF5OLO	3/8	7/16 - 20	3/4	2.39	9.2	9.2
8 FF5OLO	1/2	3/4 - 16	7/8	2.67	9.2	9.2
10 FF5OLO	5/8	7/8 - 14	1 1/16	3.14	6.0	6.0
12 FF5OLO	3/4	1 1/16 - 12	1 1/4	3.76	6.0	6.0
16 FF5OLO	1	1 5/16 - 12	1 1/2	4.14	6.0	6.0
20 FF5OLO	1 1/4	1 5/8 - 12	1 7/8	4.76	6.0	6.0
24 FF5OLO	1 1/2	1 7/8 - 12	2 1/8	5.26	5.0	5.0

TABLE OF CONTENTS

VISUAL INDEX

FLO

Male Pipe Connector
ORFS / NPTF

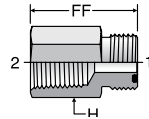


TUBE FITTING PART #	END SIZE		FF (in.)	H HEX (in.)	Dynamic Pressure (x 1,000 PSI)	
	1 (in.)	2 NPTF			-S	-SS
4 FLO	1/4	1/8 - 27	1.07	5/8	6.0	6.0
4-4 FLO	1/4	1/4 - 18	1.26	5/8	6.0	6.0
4-6 FLO	1/4	3/8 - 18	1.32	3/4	6.0	6.0
4-8 FLO	1/4	1/2 - 14	1.52	7/8	6.0	6.0
6 FLO	3/8	1/4 - 18	1.25	3/4	6.0	6.0
6-2 FLO	3/8	1/8 - 27	1.16	3/4	6.0	6.0
6-6 FLO	3/8	3/8 - 18	1.34	3/4	6.0	6.0
6-8 FLO	3/8	1/2 - 14	1.55	7/8	6.0	6.0
8 FLO	1/2	3/8 - 18	1.48	7/8	6.0	6.0
8-4 FLO	1/2	1/4 - 18	1.48	7/8	6.0	6.0
8-8 FLO	1/2	1/2 - 14	1.64	7/8	6.0	6.0
8-12 FLO	1/2	3/4 - 14	1.69	1 1/8	6.0	6.0
10 FLO	5/8	1/2 - 14	1.82	1 1/16	6.0	6.0
10-12 FLO	5/8	3/4 - 14	1.82	1 1/8	5.5	5.5
12 FLO	3/4	3/4 - 14	1.93	1 1/4	5.5	5.5
12-8 FLO	3/4	1/2 - 14	1.93	1 1/4	6.0	6.0
12-16 FLO	3/4	1 - 11 1/2	2.13	1 3/8	4.5	4.5
16 FLO	1	1 - 11 1/2	2.19	1 1/2	4.5	4.5
16-12 FLO	1	3/4 - 14	2.00	1 1/2	5.5	5.5
16-20 FLO	1	1 1/4 - 11 1/2	2.30	1 3/4	3.0	3.0
20 FLO	1 1/4	1 1/4 - 11 1/2	2.30	1 7/8	3.0	3.0
20-12 FLO	1 1/4	3/4 - 14	2.02	1 7/8	4.5	4.5
20-16 FLO	1 1/4	1 - 11 1/2	2.27	1 7/8	4.5	4.5
24 FLO	1 1/2	1 1/2 - 11 1/2	2.40	2 1/8	3.0	3.0

Dimensions and pressures for reference only, subject to change.

GLO

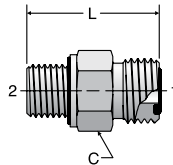
Female NPT
ORFS / Female Pipe



TUBE FITTING PART #	END SIZE		FF (in.)	H HEX (in.)	Dynamic Pressure (x 1,000 PSI)	
	1 (in.)	2 NPTF			-S	-SS
	4 GLO	1/4				
4-4 GLO	1/4	1/4 - 18	1.25	3/4	6.0	6.0
6 GLO	3/8	1/4 - 18	1.30	3/4	6.0	6.0
6-6 GLO	3/8	3/8 - 18	1.34	7/8	6.0	6.0
8 GLO	1/2	3/8 - 18	1.34	7/8	6.0	6.0

F42EDMLO

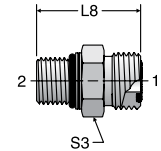
Male Connector – BSPP
(for ISO 1179-1 Port)
ORFS / BSPP-ED



TUBE FITTING PART #	END SIZE			C HEX (mm)	L (mm)	Dynamic Pressure (x 1,000 PSI)	
	1		2			S	SS
	(mm)	(in.)	BSPP				
4F42EDMLO	6	1/4	1/8 - 28	17	25.7	9.2	9.2
4-4F42EDMLO	6	1/4	1/4 - 19	19	30.5	9.2	9.2
4-6F42EDMLO	6	1/4	3/8 - 19	22	31.6	9.2	9.2
4-8F42EDMLO	6	1/4	1/2 - 14	27	35.4	6.0	6.0
6F42EDMLO	8,10	3/8	1/4 - 19	19	31.9	9.2	9.2
6-2F42EDMLO	8,10	3/8	1/8 - 28	19	31.1	9.2	9.2
6-6F42EDMLO	8,10	3/8	3/8 - 19	22	33.0	9.2	9.2
6-8F42EDMLO	8,10	3/8	1/2 - 14	27	36.5	6.0	6.0
6-12F42EDMLO	8,10	3/8	3/4 - 14	32	40.3	6.0	6.0
8F42EDMLO	12	1/2	3/8 - 19	22	34.6	9.2	9.2
8-4F42EDMLO	12	1/2	1/4 - 19	22	37.5	9.2	9.2
8-8F42EDMLO	12	1/2	1/2 - 14	27	38.4	6.0	6.0
8-12F42EDMLO	12	1/2	3/4 - 14	32	41.9	6.0	6.0
10F42EDMLO	14,15,16	5/8	1/2 - 14	27	41.1	6.0	6.0
10-6F42EDMLO	14,15,16	5/8	3/8 - 19	27	42.4	9.2	9.2
10-12F42EDMLO	14,15,16	5/8	3/4 - 14	32	44.3	6.0	6.0
12F42EDMLO	18,20	3/4	3/4 - 14	32	46.1	6.0	6.0
12-8F42EDMLO	18,20	3/4	1/2 - 14	32	48.5	6.0	6.0
12-16F42EDMLO	18,20	3/4	1 - 11	41	47.5	6.0	6.0
12-20F42EDMLO	18,20	3/4	1 1/4 - 11	50	53.0	6.0	6.0
16F42EDMLO	22,25	1	1 - 11	41	49.8	6.0	6.0
16-12F42EDMLO	22,25	1	3/4 - 14	38	50.3	6.0	6.0
16-20F42EDMLO	22,25	1	1 1/4 - 11	50	53.8	6.0	6.0
16-24F42EDMLO	22,25	1	1 1/2 - 11	55	57.5	5.0	5.0
20F42EDMLO	28,30,32	1 1/4	1 1/4 - 11	50	53.8	6.0	6.0
20-16F42EDMLO	28,30,32	1 1/4	1 - 11	48	55.9	6.0	6.0
20-24F42EDMLO	28,30,32	1 1/4	1 1/2 - 11	55	57.6	5.0	5.0
24F42EDMLO	38	1 1/2	1 1/2 - 11	55	57.6	5.0	5.0

F870MLO

Metric Straight Thread Connector
ORFS / ISO 6149

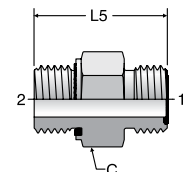


ISO 8434-3 SDS
SAE 52M0187

TUBE FITTING PART #	END SIZE			L8 (mm)	S3 HEX (mm)	Dynamic Pressure (x 1,000 PSI)	
	1		2			S	SS
	(mm)	(in.)	ISO 261				
4M12F870MLO	6	1/4	M12X1.5	28.5	17	9.2	9.2
4M14F870MLO	6	1/4	M14X1.5	29.5	19	9.2	9.2
6M12F870MLO	8,10	3/8	M12X1.5	32.0	22	9.2	9.2
6M14F870MLO	8,10	3/8	M14X1.5	32.0	22	9.2	9.2
6M16F870MLO	8,10	3/8	M16X1.5	33.5	22	9.2	9.2
6M18F870MLO	8,10	3/8	M18X1.5	36.1	24	9.2	9.2
8M14F870MLO	12	1/2	M14X1.5	35.1	24	9.2	9.2
8M16F870MLO	12	1/2	M16X1.5	36.6	24	9.2	9.2
8M18F870MLO	12	1/2	M18X1.5	38.1	24	9.2	9.2
8M22F870MLO	12	1/2	M22X1.5	39.6	27	6.0	6.0
8M27F870MLO	12	1/2	M27X2.0	44.2	32	6.0	6.0
10M18F870MLO	14,15,16	5/8	M18X1.5	41.0	27	6.0	6.0
10M22F870MLO	14,15,16	5/8	M22X1.5	42.0	27	6.0	6.0
10M27F870MLO	14,15,16	5/8	M27x2.0	47.0	32	6.0	6.0
12M22F870MLO	18,20	3/4	M22X1.5	45.0	32	6.0	6.0
12M27F870MLO	18,20	3/4	M27X2.0	48.5	32	6.0	6.0
12M33F870MLO	18,20	3/4	M33X2.0	51.5	41	6.0	6.0
16M27F870MLO	22,26	1	M27X2.0	33.6	41	6.0	6.0
16M33F870MLO	22,25	1	M33X2.0	52.0	41	6.0	6.0
20M33F870MLO	28,30,32	1 1/4	M33x2.0	35.1	46	5.0	5.0
20M42F870MLO	28,30,32	1 1/4	M42X2.0	54.5	50	5.0	5.0
24M48F870MLO	35,38	1 1/2	M48X2.0	57.0	55	5.0	5.0

F82EDMLO

Male Connector – Metric
(for ISO 9974-1 Port)
ORFS / Metric-ED



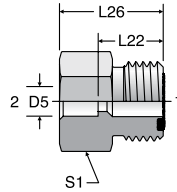
TUBE FITTING PART #	END SIZE			C HEX (mm)	L5 (mm)	Dynamic Pressure (x 1,000 PSI)	
	1		2			S	SS
	(mm)	(in.)	Metric				
4M12F82EDMLO	6	1/4	M12X1.5	17	29.7	9.2	9.2
4M14F82EDMLO	6	1/4	M14X1.5	19	30.5	9.2	9.2
6M14F82EDMLO	8,10	3/8	M14X1.5	19	31.9	9.2	9.2
6M16F82EDMLO	8,10	3/8	M16X1.5	22	31.9	9.2	9.2
8M16F82EDMLO	12	1/2	M16X1.5	22	32.0	9.2	9.2
8M18F82EDMLO	12	1/2	M18X1.5	24	34.6	9.2	9.2
10M22F82EDMLO	14,15,16	5/8	M22X1.5	27	41.1	6.0	6.0
12M22F82EDMLO	18,20	3/4	M22X1.5	32	42.7	6.0	6.0
12M27F82EDMLO	18,20	3/4	M27X2	32	46.1	6.0	6.0
16M33F82EDMLO	22,25	1	M33X2	41	49.8	6.0	6.0
20M42F82EDMLO	28,30,32	1 1/4	M42X2	50	54.0	5.0	5.0

Dimensions and pressures for reference only, subject to change.

MMLOHB3

Braze Connector
ORFS / Braze Socket

ISO 8434-3 BRS
SAE 52M0104



TUBE FITTING PART #	END SIZE		D5* TUBE SOCKET	L22 (mm)	L26 (mm)	S1 HEX	Dynamic Pressure (x 1,000 PSI)		
	1	2					S	SS	
	(mm)	(in.)							
4-6MMLOHB3	6	1/4	6	6.15	13.5	22.0	17	9.2	9.2
4-8MMLOHB3	6	1/4	8	8.15	13.5	22.0	17	9.2	9.2
6-10MMLOHB3	8, 10	3/8	10	10.15	14.5	23.0	19	9.2	9.2
8-12MMLOHB3	12	1/2	12	12.15	16.0	24.5	22	9.2	9.2
10-16MMLOHB3	14, 15, 16	5/8	16	16.15	19.0	27.5	27	6.0	6.0
12-20MMLOHB3	18, 20	3/4	20	20.18	21.0	33.5	32	6.0	6.0
16-25MMLOHB3	22, 25	1	25	25.18	24.5	38.5	41	6.0	6.0
20-30MMLOHB3	28, 30, 32	1 1/4	30	30.20	24.5	38.5	46	6.0	6.0
24-38MMLOHB3	35, 38	1 1/2	38	38.20	24.5	38.5	55	5.0	5.0

* D5 is for silver brazing. Standard steel parts are not recommended for welding.

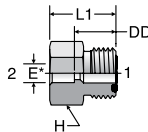
TABLE OF CONTENTS

VISUAL INDEX

LOHB3

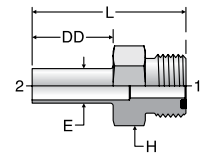
Braze Connector
ORFS / Braze Socket

SAE 520104



LOHT3

Tube Stub Connector
ORFS / Tube Weld



TUBE FITTING PART #	END SIZE		DD (in.)	E* DIA (in.)	H HEX (in.)	L1 (in.)	Dynamic Pressure (x 1,000 PSI)	
	1	2					-S	-SS
	(in.)	(in.)						
4 LOHB3	1/4	1/4	0.53	0.26	5/8	0.86	9.2	9.2
4-6 LOHB3	1/4	3/8	0.53	0.38	5/8	0.86	9.2	9.2
6 LOHB3	3/8	3/8	0.57	0.38	3/4	0.90	9.2	9.2
6-4 LOHB3	3/8	1/4	0.57	0.26	3/4	0.90	9.2	9.2
6-8 LOHB3	3/8	1/2	0.57	0.51	3/4	0.90	9.2	9.2
8 LOHB3	1/2	1/2	0.63	0.51	7/8	0.97	9.2	9.2
8-4 LOHB3**	1/2	1/4	0.64	0.26	7/8	0.97	9.2	9.2
8-6 LOHB3	1/2	3/8	0.63	0.38	7/8	0.97	9.2	9.2
8-10 LOHB3	1/2	5/8	0.63	0.63	7/8	0.97	6.0	6.0
8-12 LOHB3**	1/2	3/4	0.67	0.76	1 1/16	1.16	6.0	6.0
10 LOHB3	5/8	5/8	0.74	0.63	1 1/16	1.07	6.0	6.0
10-6 LOHB3	5/8	3/8	0.74	0.38	1 1/16	1.07	6.0	6.0
10-8 LOHB3	5/8	1/2	0.74	0.51	1 1/16	1.07	6.0	6.0
10-12 LOHB3	5/8	3/4	0.74	0.76	1 1/16	1.23	6.0	6.0
12 LOHB3	3/4	3/4	0.83	0.76	1 1/4	1.32	6.0	6.0
12-8 LOHB3	3/4	1/2	0.83	0.51	1 1/4	1.16	6.0	6.0
12-10 LOHB3	3/4	5/8	0.83	0.63	1 1/4	1.16	6.0	6.0
12-16 LOHB3	3/4	1	0.83	1.01	1 1/2	1.38	6.0	6.0
16 LOHB3	1	1	0.97	1.01	1 1/2	1.52	6.0	6.0
16-8 LOHB3**	1	1/2	0.97	0.51	1 1/2	1.30	6.0	6.0
16-12 LOHB3	1	3/4	0.97	0.76	1 1/2	1.46	6.0	6.0
16-20 LOHB3	1	1 1/4	0.96	1.26	1 3/4	1.52	6.0	6.0
20 LOHB3	1 1/4	1 1/4	0.97	1.26	1 3/4	1.52	6.0	6.0
20-16 LOHB3	1 1/4	1	0.97	1.01	1 3/4	1.52	6.0	6.0
20-24 LOHB3	1 1/4	1 1/2	0.97	1.51	2 1/8	1.52	5.0	5.0
24 LOHB3	1 1/2	1 1/2	0.97	1.51	2 1/8	1.52	5.0	5.0
24-20 LOHB3	1 1/2	1 1/4	0.97	1.26	2 1/8	1.52	5.0	5.0

* E is for silver brazing. Standard steel parts are not recommended for welding.

** Size 14 is not included in SAE J1453.

TUBE FITTING PART #	END SIZE	DD (in.)	E DIA (in.)	H HEX (in.)	L (in.)	Dynamic Pressure (x 1,000 PSI)
	1 & 2 (in.)					
4-4X035 LOHT3	1/4	0.88	0.25	5/8	1.58	5.9
6-6X035 LOHT3	3/8	0.88	0.38	3/4	1.67	3.8
8-8X065 LOHT3	1/2	1.00	0.50	7/8	1.89	5.5
12-12X065 LOHT3	3/4	1.16	0.75	1 1/4	2.35	3/5
12-16X065 LOHT3	1	1.13	1.00	1 1/4	2.32	2.6
16-16X065 LOHT3	1	1.13	1.00	1 1/2	2.40	2.6

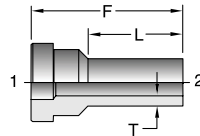
* Contact Tube Fittings Division for pressure ratings.

Dimensions and pressures for reference only, subject to change.



TLW1

Butt Weld
Sleeve



A

TABLE
OF
CONTENTS

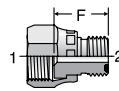
VISUAL
INDEX

TUBE FITTING PART #	END SIZE		F (in.)	L (in.)	T (in.)	Dynamic Pressure (x 1,000 PSI)	
	1 (in.)	2 (in.)				-S	-SS
4-4X035 TLW1	1/4	1/4	1.20	0.75	0.035	5950	
6-4X035 TLW1	3/8	1/4	1.26	0.75	0.035	5950	
6-4X049 TLW1	3/8	1/4	1.26	0.75	0.049	8650	
6-6X035 TLW1	3/8	3/8	1.20	0.75	0.035	3850	
6-6X049 TLW1	3/8	3/8	1.20	0.75	0.049	5550	
6-6X065 TLW1	3/8	3/8	1.20	0.75	0.065	7550	
8-8X049 TLW1	1/2	1/2	1.20	0.75	0.049	4050	
8-8X065 TLW1	1/2	1/2	1.20	0.75	0.065	5500	
12-12X065 TLW1	3/4	3/4	1.39	0.75	0.065	3500	
12-12X083 TLW1	3/4	3/4	1.39	0.75	0.083	4600	
12-12X095 TLW1	3/4	3/4	1.39	0.75	0.095	5350	
12-8X049 TLW1	3/4	1/2	1.52	0.75	0.049	4050	
16-16X083 TLW1	1	1	1.43	0.75	0.083	3400	
16-16X095 TLW1	1	1	1.43	0.75	0.095	3900	

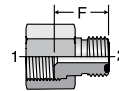
TRLON

Tube End Reducer
ORFS Swivel / ORFS Tube End

SAE 520123 (body only)
SAE 520123A (body with large nut)



* Assembled with Crimp Nut



** Assembled with Large BL Nut

TUBE FITTING PART #			END SIZE			Dynamic Pressure (x 1,000 PSI)	
TRLON	TRLON	TRLO	1 (in.)	2 (in.)	F (in.)	-S	-SS
*One Piece Design (With Crimp Nut)	**Two Piece Design (With Large Nut)	***Body Only (For Two-Piece Design Only)					
6-4 TRLON	—	—	3/8	1/4	0.77	9.2	9.2
—	8-4 TRLON	8-4 TRLO	1/2	1/4	0.87	9.2	9.2
8-6 TRLON	—	—	1/2	3/8	0.89	9.2	9.2
—	10-4 TRLON	10-4 TRLO	5/8	1/4	0.91	6.0	6.0
—	10-6 TRLON	10-6 TRLO	5/8	3/8	0.94	6.0	6.0
—	10-8 TRLON	10-8 TRLO	5/8	1/2	1.00	6.0	6.0
—	12-4 TRLON	12-4 TRLO	3/4	1/4	0.98	6.0	6.0
—	12-6 TRLON	12-6 TRLO	3/4	3/8	1.02	6.0	6.0
—	12-8 TRLON	12-8 TRLO	3/4	1/2	1.08	6.0	6.0
12-10 TRLON	—	—	3/4	5/8	1.16	6.0	6.0
—	16-8 TRLON	16-8 TRLO	1	1/2	1.14	6.0	6.0
—	16-10 TRLON	16-10 TRLO	1	5/8	1.26	6.0	6.0
16-12 TRLON	—	—	1	3/4	1.30	6.0	6.0
—	20-12 TRLON	20-12 TRLO	1 1/4	3/4	1.32	5.0	5.0
20-16 TRLON	—	—	1 1/4	1	1.34	5.0	5.0
—	24-12 TRLON-S	—	1 1/2	3/4	1.32	4.0	4.0
—	24-16 TRLON	24-16 TRLO	1 1/2	1	1.34	4.0	4.0
—	24-20 TRLON	24-20 TRLO	1 1/2	1 1/4	1.34	4.0	4.0
—	32-20 TRLON**	32-20 TRLO**	2	1 1/4	1.42	3.0	3.0
—	32-24 TRLON**	32-24 TRLO**	2	1 1/2	1.42	3.0	3.0

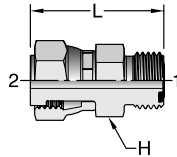
* Assembled with crimp nut.
** Assembled with large BL nut.
***To order reducer without large nut (body only) remove the "N" from the part number (i.e., TRLO).

Dimensions and pressures for reference only, subject to change.



LOHL6

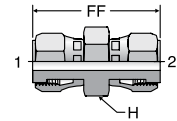
Tube End Extender / Expander
ORFS / ORFS Swivel



TUBE FITTING PART #	END SIZE		L (in.)	H HEX (in.)	Dynamic Pressure (x 1,000 PSI)	
	1 (in.)	2 (in.)			-S	-SS
	4 LOHL6	1/4			1/4	1.33
6 LOHL6	3/8	3/8	1.44	3/4	9.2	9.2
6-4 LOHL6	3/8	1/4	1.37	3/4	9.2	9.2
8 LOHL6	1/2	1/2	1.67	7/8	9.2	9.2
8-6 LOHL6	1/2	3/8	1.62	7/8	9.2	9.2
10-8 LOHL6	5/8	1/2	1.81	1 1/16	6.0	6.0
12-10 LOHL6	3/4	5/8	1.99	1 1/4	6.0	6.0
16-12 LOHL6	1	3/4	2.16	1 1/2	6.0	6.0
20-16 LOHL6	1 1/4	1	2.28	1 3/4	5.0	5.0
24-20 LOHL6	1 1/2	1 1/4	2.35	2 1/8	4.0	4.0

HL6

Swivel Nut Union
ORFS Swivel / ORFS Swivel



TUBE FITTING PART #	END SIZE		FF (in.)	H HEX (in.)	Dynamic Pressure (x 1,000 PSI)	
	1 (in.)	2 (in.)			-S	-SS
	4 HL6	1/4			1/4	1.59
6 HL6	3/8	3/8	1.77	3/4	9.2	9.2
8 HL6	1/2	1/2	2.12	7/8	9.2	9.2
10 HL6	5/8	5/8	2.42	1 1/16	6.0	6.0
12 HL6	3/4	3/4	2.74	1 1/4	6.0	6.0
16 HL6	1	1	2.95	1 7/16	6.0	6.0

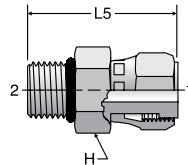
TABLE OF CONTENTS

VISUAL INDEX

F650L

Straight Thread Swivel Connector
ORFS Swivel / SAE-ORB

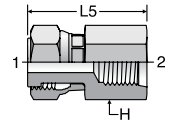
SAE 520181



TUBE FITTING PART #	END SIZE		H HEX (in.)	L5 (in.)	Dynamic Pressure (x 1,000 PSI)	
	1 (in.)	2 UN/UNF-2A			-S	-SS
	4 F650L	1/4			7/16 - 20	5/8
6 F650L	3/8	9/16 - 18	3/4	1.57	9.2	9.2
8 F650L	1/2	3/4 - 16	7/8	1.95	9.2	9.2
10 F650L	5/8	7/8 - 14	1 1/16	2.13	6.0	6.0
12 F650L	3/4	1 1/16 - 12	1 1/4	2.34	6.0	6.0
16 F650L	1	1 5/16 - 12	1 1/2	2.66	6.0	6.0
20 F650L	1 1/4	1 5/8 - 12	1 7/8	2.66	5.0	5.0

G65L

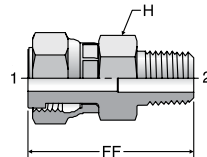
Straight Thread Swivel
Female Connector
ORFS Swivel / SAE-ORB



TUBE FITTING PART #	END SIZE		H HEX (in.)	L5 (in.)	Dynamic Pressure (x 1,000 PSI)	
	1 (in.)	2 UN/UNF-2B			-S	-SS
	4 G65L	1/4			7/16 - 20	3/4
4-6 G65L	1/4	9/16 - 18	13/16	1.45	6.0	6.0
6-4 G65L	3/8	7/16 - 20	3/4	1.51	6.0	6.0
8-4 G65L	1/2	7/16 - 20	7/8	1.57	6.0	6.0

F6L

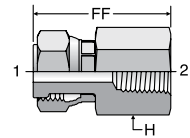
Pipe Thread Swivel Connector
ORFS Swivel / NPTF



TUBE FITTING PART #	END SIZE		FF (in.)	H HEX (in.)	Dynamic Pressure (x 1,000 PSI)	
	1 (in.)	2 NPTF			-S	-SS
	4 F6L	1/4			1/8 - 27	1.33
4-4 F6L	1/4	1/4 - 18	1.52	5/8	6.0	6.0
6 F6L	3/8	1/4 - 18	1.69	3/4	6.0	6.0
6-6 F6L	3/8	3/8 - 18	1.67	3/4	6.0	6.0
8 F6L	1/2	3/8 - 18	1.95	3/4	6.0	6.0
8-8 F6L	1/2	1/2 - 14	2.14	7/8	6.0	6.0
10 F6L	5/8	1/2 - 14	2.29	1 1/16	6.0	6.0
12 F6L	3/4	3/4 - 14	2.37	1 1/4	5.5	5.5
16 F6L	1	1 - 11 1/2	2.87	1 1/2	4.5	4.5

G6L

Female Pipe Thread Swivel Connector
ORFS Swivel / NPTF

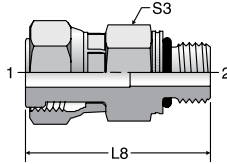


TUBE FITTING PART #	END SIZE		FF (in.)	H (in.)	Dynamic Pressure (x 1,000 PSI)	
	1 (in.)	2 NPTF			-S	-SS
	4-4 G6L	1/4			1/4 - 18	1.48
6 G6L	3/8	1/4 - 18	1.60	7/8	6.0	6.0
8-4 G6L	1/2	1/4 - 18	1.75	7/8	6.0	6.0

Dimensions and pressures for reference only, subject to change.

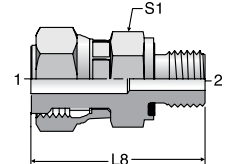
F687OML

Swivel ISO 6149 Connector
ORFS Swivel / ISO 6149



F682EDML

Swivel Metric Connector
ORFS Swivel / Metric-ED

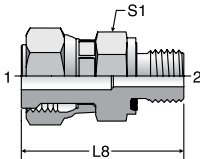


TUBE FITTING PART #	END SIZE			L8 (mm)	S3 HEX (mm)	Dynamic Pressure (x 1,000 PSI)	
	1		2			S	SS
	(mm)	(in.)	ISO 261				
4M12F687OML	6	1/4	M12x1.5	37.0	17	9.2	9.2
6M12F687OML	8, 10	3/8	M12x1.5	39.0	17	9.2	9.2
6M14F687OML	8, 10	3/8	M14x1.5	38.0	19	9.2	9.2
6M16F687OML	8, 10	3/8	M16x1.5	43.5	22	9.2	9.2
8M16F687OML	12	1/2	M16x1.5	48.0	22	9.2	9.2
10M22F687OML	14, 15, 16	5/8	M22x1.5	53.0	27	6.0	6.0
10M27F687OML	14, 15, 16	5/8	M27x2	57.0	32	6.0	6.0
12M27F687OML	18, 20	3/4	M27x2	59.5	32	6.0	6.0
16M33F687OML	22, 25	1	M33x2	67.5	41	6.0	6.0

TUBE FITTING PART #	END SIZE			L8 (mm)	S1 HEX (mm)	Dynamic Pressure (x 1,000 PSI)	
	1		2			S	SS
	(mm)	(in.)	Metric				
4M12F682EDML	6	1/4	M12x1.5	38.2	17	9.2	9.2
6M14F682EDML	8, 10	3/8	M14x1.5	40.2	19	9.2	9.2
8M16F682EDML	12	1/2	M16x1.5	47.3	22	9.2	9.2
10M22F682EDML	14, 15, 16	5/8	M22x1.5	51.8	27	6.0	6.0
12M27F682EDML	18, 20	3/4	M27x2	57.2	32	6.0	6.0
16M33F682EDML	22, 25	1	M33x2	67.0	41	6.0	6.0

F642EDML

Swivel BSPP Connector
ORFS Swivel / BSPP-ED

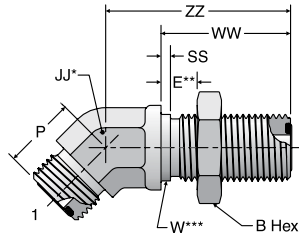


TUBE FITTING PART #	END SIZE			L8 (mm)	S1 HEX (mm)	Dynamic Pressure (x 1,000 PSI)	
	1		2			S	SS
	(mm)	(in.)	BSPP				
4F642EDML	6	1/4	1/8	34.0	14	7.2	7.2
6F642EDML	8, 10	3/8	1/4	40.2	19	9.2	9.2
8F642EDML	12	1/2	3/8	47.3	22	9.2	9.2
10F642EDML	14, 15, 16	5/8	1/2	51.8	27	6.0	6.0
12F642EDML	18, 20	3/4	3/4	57.2	32	6.0	6.0
16F642EDML	22, 25	1	1	67.0	46	6.0	6.0

WNLO

45° Bulkhead Union Elbow
ORFS / ORFS

SAE 520801
WNLO-WLNL - Body with Locknut
(See page A11 for WLNL)



TUBE FITTING PART #	END SIZE		B HEX (in.)	E MAX (in.)	JJ (in.)	P (in.)	SS (in.)	W DIA (in.)	WW (in.)	ZZ (in.)	Dynamic Pressure (x 1,000 PSI)	
	1 (in.)	2 (in.)									-S	-SS
	4 WNLO	1/4										
6 WNLO	3/8	3/8	1	0.55	3/4	0.75	0.06	0.69	1.34	1.91	9.2	9.2
8 WNLO	1/2	1/2	1 1/8	0.55	3/4	0.81	0.06	0.81	1.44	2.01	9.2	9.2
10 WNLO	5/8	5/8	1 5/16	0.55	1 1/16	0.93	0.06	1.00	1.59	2.22	6.0	6.0
12 WNLO	3/4	3/4	1 1/2	0.55	1 3/16	1.02	0.06	1.19	1.63	2.38	6.0	6.0
16 WNLO	1	1	1 3/4	0.55	1 7/16	1.18	0.06	1.44	1.65	2.56	6.0	6.0
20 WNLO	1 1/4	1 1/4	2	0.55	1 5/8	1.26	0.06	1.69	1.65	2.64	5.0	5.0
24 WNLO	1 1/2	1 1/2	2 3/8	0.55	1 7/8	1.46	0.06	2.00	1.65	2.64	4.0	4.0

* JJ – Across wrench flats.

** E – Maximum bulkhead thickness.

*** W – Bulkhead pilot diameter. Recommended clearance hole is W + 0.015".

Dimensions and pressures for reference only, subject to change.

A

TABLE OF CONTENTS

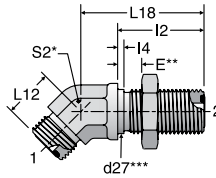
VISUAL INDEX



WNMLO

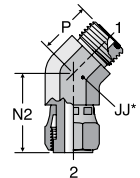
45° Bulkhead Union Elbow – mm Hex
ORFS / ORFS

ISO 8434-3 BHE45
SAE 52M0801
WNMLO-WLNML - Body with Locknut
(See page A11 for WLNML)



V6LO

45° Swivel Nut Elbow
ORFS / ORFS Swivel



* JJ – Across Wrench Flats

TUBE FITTING PART #	END SIZE		d27*** (mm)	E (mm)	I2 (mm)	I4 (mm)	L12 (mm)	L18 (mm)	S2 (mm)	Dynamic Pressure (x 1,000 PSI)	
	1 & 2									S	SS
	(mm)	(in.)									
4WNMLO	6	1/4	14.3	14	31.5	1.5	16.0	44.0	14	9.2	9.2
6WNMLO	8,10	3/8	17.5	14	34.0	1.5	19.0	48.5	19	9.2	9.2
8WNMLO	12	1/2	20.6	14	36.5	1.5	20.5	51.0	19	9.2	9.2
10WNMLO	14,15,16	5/8	25.4	14	40.5	1.5	23.5	56.5	27	6.0	6.0
12WNMLO	18,20	3/4	30.2	14	41.5	1.5	26.0	60.5	30	6.0	6.0
16WNMLO	22,25	1	36.5	14	42.0	1.5	30.0	65.0	36	6.0	6.0
20WNMLO	28,30,32	1 1/4	42.9	14	42.0	1.5	32.0	67.0	41	5.0	5.0
24WNMLO	35,38	1 1/2	50.8	14	42.0	1.5	37.0	67.0	50	4.0	4.0

* S2 – Across Wrench Flats.

** E – Maximum bulkhead thickness.

***d27 – Bulkhead pilot diameter. Recommended clearance hole is d27 + 0.4 mm.

TUBE FITTING PART #	END SIZE		JJ (in.)	N2 (in.)	P (in.)	Dynamic Pressure (x 1,000 PSI)	
	1 & 2					-S	-SS
	(in.)						
4 V6LO	1/4	9/16	0.99	0.63	9.2	9.2	
6 V6LO	3/8	3/4	1.12	0.74	9.2	9.2	
8 V6LO	1/2	3/4	1.49	0.80	9.2	9.2	
10 V6LO	5/8	1 1/16	1.53	0.92	6.0	6.0	
12 V6LO	3/4	1 3/16	1.73	1.02	6.0	6.0	
16 V6LO	1	1 7/16	1.87	1.18	6.0	6.0	
20 V6LO	1 1/4	1 5/8	1.98	1.26	5.0	5.0	
24 V6LO	1 1/2	1 7/8	2.06	1.45	4.0	4.0	

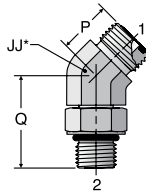
TABLE OF CONTENTS

VISUAL INDEX

V5OLO

45° Straight Thread Elbow
ORFS / SAE-ORB

SAE 520320

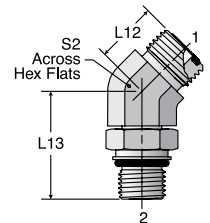


* JJ – Across Hex Flats

V87OMLO

45° Metric Straight Thread Elbow
ORFS / ISO 6149

ISO 8434-3 SDE45
SAE 52M0387



* S2 – Across Hex Flats

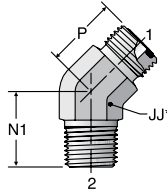
TUBE FITTING PART #	END SIZE		JJ (in.)	P (in.)	Q (in.)	Dynamic Pressure (x 1,000 PSI)	
	1	2				-S	-SS
	(in.)	UNUNF-2A					
4 V5OLO	1/4	7/16 - 20	9/16	0.63	1.18	6.0	6.0
4-6 V5OLO	1/4	9/16 - 18	3/4	0.69	1.30	6.0	6.0
6 V5OLO	3/8	9/16 - 18	3/4	0.75	1.30	6.0	6.0
6-4 V5OLO	3/8	7/16 - 20	3/4	0.75	1.22	6.0	6.0
6-8 V5OLO	3/8	3/4 - 16	3/4	0.75	1.44	6.0	6.0
8 V5OLO	1/2	3/4 - 16	3/4	0.81	1.44	6.0	6.0
8-6 V5OLO	1/2	9/16 - 18	3/4	0.81	1.28	6.0	6.0
8-10 V5OLO	1/2	7/8 - 14	3/4	0.85	1.75	6.0	6.0
10 V5OLO	5/8	7/8 - 14	1 1/16	0.93	1.75	6.0	6.0
10-8 V5OLO	5/8	3/4 - 16	1 1/16	0.93	1.57	6.0	6.0
10-12 V5OLO	5/8	1 1/16 - 12	1 3/16	0.96	1.97	6.0	6.0
12 V5OLO	3/4	1 1/16 - 12	1 3/16	1.02	1.97	6.0	6.0
12-10 V5OLO	3/4	7/8 - 14	1 3/16	1.02	1.81	6.0	6.0
12-16 V5OLO	3/4	1 5/16 - 12	1 7/16	1.16	2.07	5.5	5.5
16 V5OLO	1	1 5/16 - 12	1 7/16	1.18	2.07	5.5	5.5
16-10 V5OLO	1	7/8 - 14	1 7/16	1.18	2.03	6.0	6.0
16-12 V5OLO	1	1 1/16 - 12	1 7/16	1.18	2.03	6.0	6.0
16-20 V5OLO	1	1 5/8 - 12	1 5/8	1.26	2.11	4.0	4.0
20 V5OLO	1 1/4	1 5/8 - 12	1 5/8	1.26	2.11	4.0	4.0
24 V5OLO	1 1/2	1 7/8 - 12	1 7/8	1.46	2.11	4.0	4.0

TUBE FITTING PART #	END SIZE			L12 (mm)	L13 (mm)	S2 (mm)	Dynamic Pressure (x 1,000 PSI)	
	1	2	-S				-SS	
	(mm)	(in.)						ISO 261
4M12V87OMLO	6	1/4	M12X1.5	16.0	30.0	14	6.0	6.0
4M14V87OMLO	6	1/4	M14X1.5	17.5	31.5	17	6.0	6.0
6M16V87OMLO	8,10	3/8	M16X1.5	19.0	33.5	19	6.0	6.0
8M18V87OMLO	12	1/2	M18X1.5	20.5	37.0	19	6.0	6.0
10M22V87OMLO	14,15,16	5/8	M22X1.5	23.5	44.0	27	6.0	6.0
12M27V87OMLO	18,20	3/4	M27X2	26.0	50.5	27	6.0	6.0
16M33V87OMLO	22,25	1	M33X2	30.0	52.5	36	5.0	5.0
20M42V87OMLO	28,30,32	1 1/4	M42X2	32.0	54.0	41	4.0	4.0
24M48V87OMLO	35,38	1 1/2	M48X2	37.0	56.5	50	4.0	4.0

Dimensions and pressures for reference only, subject to change.

VLO

45° Male Elbow
ORFS / NPTF

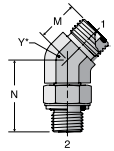


* JJ – Across Wrench Flats

TUBE FITTING PART #	END SIZE		JJ (in.)	N1 (in.)	P (in.)	Dynamic Pressure (x 1,000 PSI)	
	1 (in.)	2 NPTF				-S	-SS
	4 VLO	1/4					
4-4 VLO	1/4	1/4 - 18	9/16	0.86	0.68	6.0	6.0
6 VLO	3/8	1/4 - 18	3/4	0.87	0.74	6.0	6.0
6-6 VLO	3/8	3/8 - 18	3/4	0.87	0.74	6.0	6.0
8 VLO	1/2	3/8 - 18	3/4	0.95	0.80	6.0	6.0
8-8 VLO	1/2	1/2 - 14	7/8	1.17	0.86	6.0	6.0
10 VLO	5/8	1/2 - 14	1 1/16	1.17	0.92	6.0	6.0
12 VLO	3/4	3/4 - 14	1 5/16	1.30	1.02	4.0	4.0
16 VLO	1	1 - 11 1/2	1 7/16	1.48	1.18	3.0	3.0
20 VLO	1 1/4	1 1/4 - 11 1/2	1 5/8	1.67	1.26	2.5	2.5

V40MLO

Male 45° Elbow – BSPP
(for ISO 1179-1 Port)
ORFS / BSPP-ORR



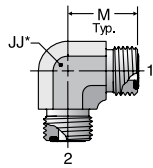
* Y – Across Hex Flats

TUBE FITTING PART #	END SIZE		M (mm)	N (mm)	Y (mm)	Dynamic Pressure (x 1,000 PSI)	
	1 (mm)	2 (in.) BSPP				S	SS
	4V40MLO	6					
4-4V40MLO	6	1/4 1/4 - 19	17.5	32.0	19	4.0	4.0
6V40MLO	8,10	3/8 1/4 - 19	19.0	32.0	19	4.0	4.0
6-6V40MLO	8,10	3/8 3/8 - 19	19.0	33.5	19	4.0	4.0
6-8V40MLO	8,10	3/8 1/2 - 14	19.5	43.5	27	4.0	4.0
8V40MLO	12	1/2 3/8 - 19	20.5	33.5	19	4.0	4.0
8-8V40MLO	12	1/2 1/2 - 14	21.0	43.5	27	4.0	4.0
10V40MLO	14,15,16	5/8 1/2 - 14	23.5	43.5	27	4.0	4.0
10-12V40MLO	14,15,16	5/8 3/4 - 14	24.5	46.5	30	4.0	4.0
12V40MLO	18,20	3/4 3/4 - 14	26.0	46.5	30	4.0	4.0
12-16V40MLO	18,20	3/4 1 - 11	26.0	51.0	37	4.0	4.0
16V40MLO	22,25	1 1 - 11	30.0	51.0	37	4.0	4.0

ELO

Union Elbow
ORFS / ORFS

SAE 520201



* JJ – Across Wrench Flats

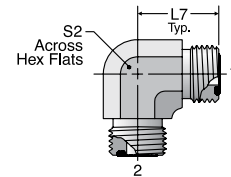
TUBE FITTING PART #	END SIZE		JJ (in.)	M (in.)	Dynamic Pressure (x 1,000 PSI)	
	1 (in.)	2 (in.)			-S	-SS
	4 ELO	1/4				
6 ELO	3/8	3/8	3/4	0.98	9.2	9.2
8 ELO	1/2	1/2	3/4	1.10	9.2	9.2
10 ELO	5/8	5/8	1 1/16	1.32	6.0	6.0
12 ELO	3/4	3/4	1 3/16	1.48	6.0	6.0
16 ELO	1	1	1 7/16	1.63	6.0	6.0
20 ELO	1 1/4	1 1/4	1 5/8	1.75	5.0	5.0
24 ELO	1 1/2	1 1/2	1 7/8	1.93	4.0	4.0
32 ELO*	2	2	2 1/2	2.76	3.0	3.0

** Size 32 is not included in SAE J1453.

EMLO

Union Elbow – mm Hex
ORFS / ORFS

ISO 8434-3 E
SAE 52M0201



TUBE FITTING PART #	END SIZE		L7 (mm)	S2 (mm)	Dynamic Pressure (x 1,000 PSI)	
	1 & 2 (mm)				S	SS
	4EMLO	6				
6EMLO	8,10	3/8	25.0	19	9.2	9.2
8EMLO	12	1/2	28.0	19	9.2	9.2
10EMLO	14,15,16	5/8	33.5	27	6.0	6.0
12EMLO	18,20	3/4	37.5	30	6.0	6.0
16EMLO	22,25	1	41.5	36	6.0	6.0
20EMLO	28,30,32	1 1/4	44.5	41	5.0	5.0
24EMLO	35,38	1 1/2	49.0	50	4.0	4.0

Dimensions and pressures for reference only, subject to change.



WELO

Bulkhead Union Elbow
 ORFS / ORFS

SAE 520701
 WELO-WLNL - Body with Locknut
 (See page A11 for WLNL)

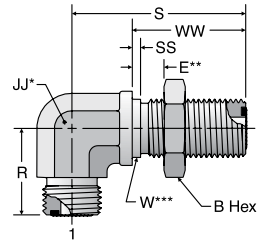


TABLE
 OF
 CONTENTS

VISUAL
 INDEX

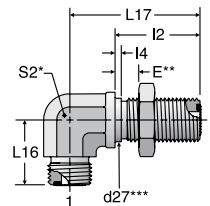
TUBE FITTING PART #	END SIZE		B HEX (in.)	E MAX (in.)	JJ (in.)	R (in.)	S (in.)	SS (in.)	W (in.)	WW (in.)	Dynamic Pressure (x 1,000 PSI)	
	1 (in.)	2 (in.)									-S	-SS
4 WELO	1/4	1/4	13/16	0.55	9/16	0.89	1.85	0.06	0.56	1.24	9.2	9.2
6 WELO	3/8	3/8	1	0.55	3/4	1.02	2.05	0.06	0.69	1.34	9.2	9.2
8 WELO	1/2	1/2	1 1/8	0.55	3/4	1.14	2.19	0.06	0.81	1.44	9.2	9.2
10 WELO	5/8	5/8	1 5/16	0.55	1 1/16	1.36	2.48	0.06	1.00	1.59	6.0	6.0
12 WELO	3/4	3/4	1 1/2	0.55	1 3/16	1.52	2.64	0.06	1.19	1.63	6.0	6.0
16 WELO	1	1	1 3/4	0.55	1 7/16	1.67	2.80	0.06	1.44	1.65	6.0	6.0
20 WELO	1 1/4	1 1/4	2	0.55	1 5/8	1.79	2.97	0.06	1.69	1.65	5.0	5.0
24 WELO	1 1/2	1 1/2	2 3/8	0.55	1 7/8	1.95	3.13	0.06	2.00	1.65	4.0	4.0

* JJ – Across wrench flats.
 ** E – Maximum bulkhead thickness.
 *** W – Bulkhead pilot diameter. Recommended clearance hole is $W + 0.015"$.

WEMLO

Bulkhead Union Elbow – mm Hex
 ORFS / ORFS

ISO 8434-3 BHE
 SAE 52M0701
 WEMLOWLNL - Body with Locknut
 (See page A11 for WLNL)



TUBE FITTING PART #	END SIZE		d27*** (mm)	E (mm)	I2 (mm)	I4 (mm)	L16 (mm)	L17 (mm)	S2 (mm)	Dynamic Pressure (x 1,000 PSI)	
	1 & 2 (mm)	(in.)								S	SS
4WEMLO	6	1/4	14.3	14	31.5	1.5	22.5	47.0	14	9.2	9.2
6WEMLO	8,10	3/8	17.5	14	34.0	1.5	26.0	52.0	19	9.2	9.2
8WEMLO	12	1/2	20.6	14	36.5	2.5	29.0	55.5	19	9.2	9.2
10WEMLO	14,15,16	5/8	25.4	14	40.5	2.5	34.5	63.0	27	6.0	6.0
12WEMLO	18,20	3/4	30.2	14	41.5	3.0	38.5	67.0	30	6.0	6.0
16WEMLO	22,25	1	36.5	14	42.0	3.0	42.5	71.0	36	6.0	6.0
20WEMLO	28,30,32	1 1/4	42.9	14	42.0	3.0	45.5	75.5	41	5.0	5.0
24WEMLO	35,38	1 1/2	50.8	14	42.0	3.0	49.5	79.5	50	4.0	4.0

* S2 – Across wrench flats.
 ** E – Maximum bulkhead thickness.
 ***d27 - Bulkhead pilot diameter. Recommended clearance is $d27 + 0.4$ mm.

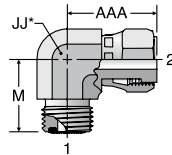
Dimensions and pressures for reference only, subject to change.



C6LO

Swivel Nut Elbow
ORFS / ORFS Swivel

SAE 520221



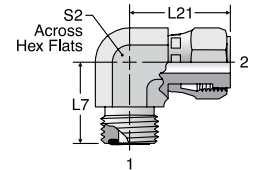
* JJ – Across Wrench Flats

TUBE FITTING PART #	END SIZE		AAA (in.)	JJ (in.)	M (in.)	Dynamic Pressure (x 1,000 PSI)	
	1 (in.)	2 (in.)				-S	-SS
	4 C6LO	1/4					
6 C6LO	3/8	3/8	1.17	3/4	0.98	9.2	9.2
8 C6LO	1/2	1/2	1.50	3/4	1.10	9.2	9.2
10 C6LO	5/8	5/8	1.61	1 1/16	1.32	6.0	6.0
12 C6LO	3/4	3/4	1.83	1 3/16	1.48	6.0	6.0
16 C6LO	1	1	2.11	1 7/16	1.64	6.0	6.0
20 C6LO	1 1/4	1 1/4	2.28	1 5/8	1.75	5.0	5.0
24 C6LO	1 1/2	1 1/2	2.41	1 7/8	1.92	4.0	4.0

C6MLO

Swivel Nut Elbow – mm Hex
ORFS / ORFS Swivel

ISO 8434-3 SWE
SAE 52M0221



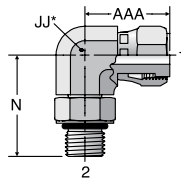
* S2 – Across Hex Flats

TUBE FITTING PART #	END SIZE		L7 (mm)	L21 (mm)	S2 (mm)	Dynamic Pressure (x 1,000 PSI)	
	1 (mm)	2 (in.)				-S	-SS
	4C6MLO	6					
6C6MLO	8,10	3/8	25.0	29.7	19	9.2	9.2
8C6MLO	12	1/2	28.0	38.0	19	9.2	9.2
10C6MLO	14,15,16	5/8	33.5	41.0	27	6.0	6.0
12C6MLO	18,20	3/4	37.5	46.5	30	6.0	6.0
16C6MLO	22,25	1	41.6	53.5	36	6.0	6.0
20C6MLO	28,30,32	1 1/4	44.5	58.0	41	4.0	4.0
24C6MLO	35,38	1 1/2	48.8	61.0	50	4.0	4.0

AOEL6

Straight Thread Swivel Elbow
ORFS Swivel / SAE-ORB

SAE 520281



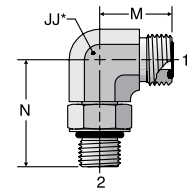
* JJ – Across Wrench Flats

TUBE FITTING PART #	END SIZE		AAA (in.)	JJ (in.)	N (in.)	Dynamic Pressure (x 1,000 PSI)	
	1 (in.)	2 UN/UNF-2A				-S	-SS
	4 AOEL6	1/4					
6 AOEL6	3/8	9/16 - 18	1.17	3/4	1.46	6.0	6.0
8 AOEL6	1/2	3/4 - 16	1.50	3/4	1.59	6.0	6.0
10 AOEL6	5/8	7/8 - 14	1.65	1 1/16	1.97	6.0	6.0
12 AOEL6	3/4	1 1/16 - 12	1.79	1 1/16	2.17	6.0	6.0
16 AOEL6	1	1 5/16 - 12	2.07	1 5/16	2.34	5.5	5.5
20 AOEL6	1 1/4	1 5/8 - 12	2.28	1 5/8	2.44	4.0	4.0
24 AOEL6	1 1/2	1 7/8 - 12	2.40	1 7/8	2.60	4.0	4.0

C5OLO

Straight Thread Elbow
ORFS / SAE-ORB

SAE 520220



* JJ – Across Wrench Flats

TUBE FITTING PART #	END SIZE		JJ (in.)	M (in.)	N (in.)	Dynamic Pressure (x 1,000 PSI)	
	1 (in.)	2 UN/UNF-2A				-S	-SS
	4 C5OLO	1/4					
4-6 C5OLO***	1/4	9/16 - 18	9/16	0.93	1.46	6.0	6.0
4-8 C5OLO	1/4	3/4 - 16	3/4	0.98	1.59	6.0	6.0
6 C5OLO	3/8	9/16 - 18	3/4	0.98	1.46	6.0	6.0
6-4 C5OLO	3/8	7/16 - 20	3/4	0.98	1.38	6.0	6.0
6-5 C5OLO	3/8	1/2 - 20	3/4	0.98	1.38	6.0	6.0
6-8 C5OLO	3/8	3/4 - 16	3/4	1.04	1.59	6.0	6.0
6-10 C5OLO***	3/8	7/8 - 14	7/8	1.15	1.97	6.0	6.0
6-12 C5OLO	3/8	1 1/16 - 12	1 1/16	1.28	2.17	6.0	6.0
8 C5OLO	1/2	3/4 - 16	3/4	1.10	1.59	6.0	6.0
8-6 C5OLO	1/2	9/16 - 18	3/4	1.10	1.44	6.0	6.0
8-10 C5OLO***	1/2	7/8 - 14	7/8	1.21	1.97	6.0	6.0
8-12 C5OLO	1/2	1 1/16 - 12	1 3/16	1.32	2.17	6.0	6.0
10 C5OLO	5/8	7/8 - 14	1 1/16	1.32	1.97	6.0	6.0
10-8 C5OLO	5/8	3/4 - 16	1 1/16	1.32	1.81	6.0	6.0
10-12 C5OLO	5/8	1 1/16 - 12	1 3/16	1.42	2.17	6.0	6.0
12 C5OLO	3/4	1 1/16 - 12	1 3/16	1.48	2.17	6.0	6.0
12-8 C5OLO	3/4	3/4 - 16	1 3/16	1.48	1.83	6.0	6.0
12-10 C5OLO	3/4	7/8 - 14	1 3/16	1.48	2.01	6.0	6.0
12-16 C5OLO	3/4	1 5/16 - 12	1 7/16	1.61	2.34	5.5	5.5
16 C5OLO	1	1 5/16 - 12	1 7/16	1.63	2.34	5.5	5.5
16-12 C5OLO	1	1 1/16 - 12	1 7/16	1.63	2.30	6.0	6.0
16-20 C5OLO	1	1 5/8 - 12	1 5/8	1.75	2.44	4.0	4.0
20 C5OLO	1 1/4	1 5/8 - 12	1 5/8	1.75	2.44	4.0	4.0
20-16 C5OLO	1 1/4	1 5/16 - 12	1 5/8	1.75	2.44	4.0	4.0
20-24 C5OLO	1 1/4	1 7/8 - 12	1 7/8	1.93	2.60	4.0	4.0
24 C5OLO	1 1/2	1 7/8 - 12	1 7/8	1.93	2.60	4.0	4.0
24-20 C5OLO	1 1/2	1 5/8 - 12	1 7/8	1.93	2.60	4.0	4.0
32 C5OLO**	2	2 1/2 - 12	2 1/2	2.76	3.07	2.5	2.5

** Size 32 is not included in SAE J1453.

*** JJ for these parts does not conform to SAE.

Dimensions and pressures for reference only, subject to change.

A

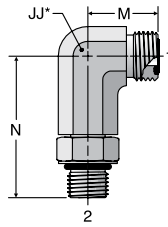
TABLE OF CONTENTS

VISUAL INDEX

CC5OLO

Long Straight Thread Elbow
ORFS-Long / SAE-ORB

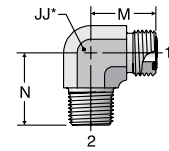
SAE 521520



* JJ – Across Wrench Flats

CLO

Male Pipe Elbow
ORFS / NPTF



* JJ – Across Wrench Flats

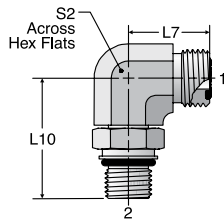
TUBE FITTING PART #	END SIZE		JJ (in.)	M (in.)	N (in.)	Dynamic Pressure (x 1,000 PSI)	
	1 (in.)	2 UN-UNF-2A				-S	-SS
	4 CC5OLO	1/4					
6 CC5OLO	3/8	9/16 - 18	3/4	0.98	2.62	6.0	6.0
8 CC5OLO	1/2	3/4 - 16	3/4	1.10	2.95	6.0	6.0
10 CC5OLO	5/8	7/8 - 14	1 1/16	1.32	3.50	6.0	6.0
12 CC5OLO	3/4	1 1/16 - 12	1 5/16	1.48	3.98	6.0	6.0
16 CC5OLO	1	1 5/16 - 12	1 5/8	1.63	4.49	5.5	5.5

TUBE FITTING PART #	END SIZE		JJ (in.)	M (in.)	N (in.)	Dynamic Pressure (x 1,000 PSI)	
	1 (in.)	2 NPTF				-S	-SS
	4 CLO	1/4					
4-4 CLO	1/4	1/4 - 18	9/16	0.85	1.12	6.0	6.0
4-6 CLO	1/4	3/8 - 18	3/4	0.97	1.22	6.0	6.0
4-8 CLO	1/4	1/2 - 14	7/8	1.07	1.47	6.0	6.0
6 CLO	3/8	1/4 - 18	3/4	0.98	1.09	6.0	6.0
6-6 CLO	3/8	3/8 - 18	3/4	0.98	1.22	6.0	6.0
6-8 CLO	3/8	1/2 - 14	7/8	1.15	1.47	6.0	6.0
8 CLO	1/2	3/8 - 18	3/4	1.10	1.22	6.0	6.0
8-4 CLO	1/2	1/4 - 18	3/4	1.10	1.22	6.0	6.0
8-8 CLO	1/2	1/2 - 14	7/8	1.10	1.47	6.0	6.0
8-12 CLO	1/2	3/4 - 14	1 1/16	1.32	1.59	4.0	4.0
10 CLO	5/8	1/2 - 14	1 1/16	1.31	1.47	6.0	6.0
10-6 CLO	5/8	3/8 - 18	1 1/16	1.31	1.28	6.0	6.0
10-12 CLO	5/8	3/4 - 14	1 3/16	1.41	1.59	4.0	4.0
12 CLO	3/4	3/4 - 14	1 3/16	1.47	1.59	4.0	4.0
12-8 CLO	3/4	1/2 - 14	1 3/16	1.47	1.59	6.0	6.0
12-16 CLO	3/4	1 - 11 1/2	1 5/16	1.62	1.97	3.0	3.0
16 CLO	1	1 - 11 1/2	1 7/16	1.64	1.97	3.0	3.0
16-12 CLO	1	3/4 - 14	1 7/16	1.64	1.78	4.0	4.0
20 CLO	1 1/4	1 1/4 - 11 1/2	1 5/8	1.76	2.38	2.5	2.5
24 CLO	1 1/2	1 1/2 - 11 1/2	1 7/8	1.92	2.64	2.5	2.5
24-20 CLO	1 1/2	1 1/4 - 11 1/2	1 7/8	1.92	2.61	2.5	2.5

C87OMLO

90° Metric Straight Thread Elbow
ORFS / ISO 6149

ISO 8434-3 SDE
SAE 52M0287



TUBE FITTING PART #	END SIZE			L7 (mm)	L10 (mm)	S2 (mm)	Dynamic Pressure (x 1,000 PSI)	
	1		2				S	SS
	(mm)	(in.)	ISO 261					
4M12C87OMLO	6	1/4	M12X1.5	21.5	33.0	14	6.0	6.0
4M14C87OMLO	6	1/4	M14X1.5	23.5	35.5	14	6.0	6.0
6M12C87OMLO	8,10	3/8	M12X1.5	25.0	35.5	19	6.0	6.0
6M14C87OMLO	8,10	3/8	M14X1.5	25.0	35.5	19	6.0	6.0
6M16C87OMLO	8,10	3/8	M16X1.5	25.0	37.5	19	6.0	6.0
8M14C87OMLO	12	1/2	M14X1.5	28.0	36.0	19	6.0	6.0
8M18C87OMLO	12	1/2	M18X1.5	28.0	41.0	19	6.0	6.0
8M22C87OMLO	12	1/2	M22X1.5	31.0	49.0	27	6.0	6.0
10M18C87OMLO	14,15,16	5/8	M18X1.5	33.5	47.5	27	6.0	6.0
10M22C87OMLO	14,15,16	5/8	M22X1.5	33.5	49.0	27	6.0	6.0
12M22C87OMLO	18,20	3/4	M22X1.5	37.5	49.0	27	6.0	6.0
12M27C87OMLO	18,20	3/4	M27X2	37.5	55.5	27	6.0	6.0
16M33C87OMLO	22,25	1	M33X2	41.5	59.5	36	5.0	5.0
20M38C87OMLO*	28,30,32	1 1/4	M38X2	44.5	62.0	41	4.0	4.0
20M42C87OMLO	28,30,32	1 1/4	M42X2	44.5	63.0	41	4.0	4.0
24M48C87OMLO	35,38	1 1/2	M48X2	49.0	71.5	50	4.0	4.0

* For special M38x2 (ISO 6149-1 style) port. The current ISO 6149 does not include the M38 size.

TABLE OF CONTENTS

VISUAL INDEX

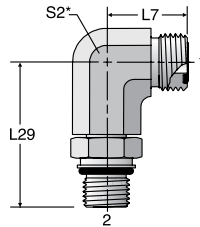
Dimensions and pressures for reference only, subject to change.



CC87OMLO

Long 90° Metric Straight Thread Elbow
ORFS-Long / ISO 6149

ISO 8434-3 SDEL
SAE 52M1587

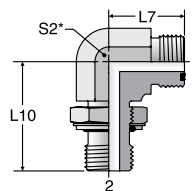


* S2 – Across Hex Flats

TUBE FITTING PART #	END SIZE			L7 (mm)	L29 (mm)	S2 (mm)	Dynamic Pressure (x 1,000 PSI)	
	1		2				S	SS
	(mm)	(in.)	ISO 261					
4M12CC87OMLO	6	1/4	M12X1.5	21.5	56.5	14	6.0	6.0
6M14CC87OMLO	8,10	3/8	M14X1.5	25.0	56.5	17	6.0	6.0
6M16CC87OMLO	8,10	3/8	M16X1.5	25.0	66.5	17	6.0	6.0
8M18CC87OMLO	12	1/2	M18X1.5	28.0	75.0	19	6.0	6.0
8M22CC87OMLO	12	1/2	M22X1.5	31.5	88.0	27	6.0	6.0
10M22CC87OMLO	14,15,16	5/8	M22X1.5	33.5	88.0	27	6.0	6.0
12M27CC87OMLO	18,20	3/4	M27X2	37.5	100.5	27	6.0	6.0
16M33CC87OMLO	22,25	1	M33X2	41.5	114.5	36	5.0	5.0
20M42CC87OMLO	28,30,32	1 1/4	M42X2	44.5	126.5	41	4.0	4.0

C8OMLO

Metric Straight Thread Elbow
ORFS / Metric-ORR



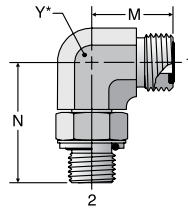
* S2 – Across Hex Flats

TUBE FITTING PART #	END SIZE			L7 (mm)	L10 (mm)	S2 (mm)	Dynamic Pressure (x 1,000 PSI)	
	1		2				S	SS
	(mm)	(in.)	ISO 261					
4M12C8OMLO	6	1/4	M12X1.5	21.5	33.0	14	3.6	3.6
6M12C8OMLO	8, 10	3/8	M12X1.5	25.0	35.5	19	3.6	3.6
6M14C8OMLO	8, 10	3/8	M14X1.5	25.0	35.5	19	3.6	3.6
6M16C8OMLO	8, 10	3/8	M16X1.5	25.0	37.5	19	3.6	3.6
8M14C8OMLO	12	1/2	M14X1.5	28.0	36.0	19	3.6	3.6
8M18C8OMLO	12	1/2	M18X1.5	28.0	41.0	19	3.6	3.6
8M22C8OMLO	12	1/2	M22X1.5	31.5	49.0	27	3.6	3.6
10M22C8OMLO	14, 15, 16	5/8	M22X1.5	33.5	49.0	27	3.6	3.6
12M27C8OMLO	18, 20	3/4	M27X2	37.5	55.5	30	3.6	3.6
16M33C8OMLO	22, 25	1	M33X2	41.5	59.5	36	2.5	2.5
20M38C8OMLO	28, 30, 32	1 1/4	M38X2	44.5	62.0	41	2.5	2.5
20M42C8OMLO	28, 30, 32	1 1/4	M42X2	44.5	63.0	41	2.5	2.5

Dimensions and pressures for reference only, subject to change.

C4OMLO

Male Elbow – BSPP
(for ISO 1179-1 Port)
ORFS / BSPP-ORR

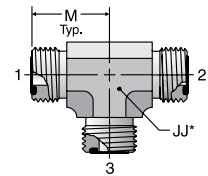


* Y – Across Wrench Flats

JLO

Union Tee
ORFS (all three ends)

SAE 520401



* JJ – Across Wrench Flats

TABLE OF CONTENTS

VISUAL INDEX

TUBE FITTING PART #	END SIZE			M (mm)	N (mm)	Y (mm)	Dynamic Pressure (x 1,000 PSI)	
	1		2				S	SS
	(mm)	(in.)	BSPP					
4C4OMLO	6	1/4	1/8 - 28	21.5	30.0	14	4.0	4.0
4-4C4OMLO	6	1/4	1/4 - 19	23.5	36.0	19	4.0	4.0
4-6C4OMLO	6	1/4	3/8 - 19	24.5	38.0	19	4.0	4.0
6C4OMLO	8,10	3/8	1/4 - 19	25.0	36.0	19	4.0	4.0
6-6C4OMLO	8,10	3/8	3/8 - 19	26.5	38.0	19	4.0	4.0
8-4C4OMLO	12	1/2	1/4 - 19	28.0	35.5	19	4.0	4.0
8C4OMLO	12	1/2	3/8 - 19	28.0	38.0	19	4.0	4.0
8-8C4OMLO	12	1/2	1/2 - 14	31.0	48.5	27	4.0	4.0
8-12C4OMLO	12	1/2	3/4 - 14	33.5	51.5	30	4.0	4.0
10-6C4OMLO	14,15,16	5/8	3/8 - 19	33.5	40.5	27	4.0	4.0
10C4OMLO	14,15,16	5/8	1/2 - 14	33.5	48.5	27	4.0	4.0
10-12C4OMLO	14,15,16	5/8	3/4 - 14	36.0	51.5	30	4.0	4.0
10-16C4OMLO	14,15,16	5/8	1 - 11	39.5	58.5	36	4.0	4.0
12-8C4OMLO	18,20	3/4	1/2 - 14	37.5	49.5	30	4.0	4.0
12C4OMLO	18,20	3/4	3/4 - 14	37.5	51.5	30	4.0	4.0
12-16C4OMLO	18,20	3/4	1 - 11	41.0	58.5	36	4.0	4.0
16-12C4OMLO	22,25	1	3/4 - 14	41.5	56.0	36	4.0	4.0
16C4OMLO	22,25	1	1 - 11	41.5	58.5	36	4.0	4.0
16-20C4OMLO	22,25	1	1 1/4 - 11	44.5	61.0	41	3.0	3.0
20-16C4OMLO	28,30,32	1 1/4	1 - 11	44.5	61.0	41	4.0	4.0
20C4OMLO	28,30,32	1 1/4	1 1/4 - 11	44.5	61.0	41	2.0	2.0
20-24C4OMLO	28,30,32	1 1/4	1 1/2 - 11	49.0	64.5	50	2.0	2.0
24C4OMLO	35,38	1 1/2	1 1/2 - 11	49.0	64.5	50	2.0	2.0

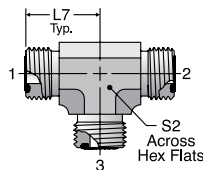
TUBE FITTING PART #	END SIZE		M (in.)	Dynamic Pressure (x 1,000 PSI)	
	1-3 (in.)	JJ (in.)		-S	-SS
	4 JLO	1/4			
6 JLO	3/8	3/4	0.98	9.2	9.2
8 JLO	1/2	3/4	1.10	9.2	9.2
10 JLO	5/8	1 1/16	1.32	6.0	6.0
12 JLO	3/4	1 3/16	1.48	6.0	6.0
16 JLO	1	1 7/16	1.63	6.0	6.0
20 JLO	1 1/4	1 5/8	1.75	5.0	5.0
24 JLO	1 1/2	1 7/8	1.93	4.0	4.0
32 JLO*	2	2 1/2	2.76	3.0	3.0

* Size 32 is not included in SAE J1453.

JMLO

Union Tee – mm Hex
ORFS (all three ends)

ISO 8434-3 T
SAE 52M0401

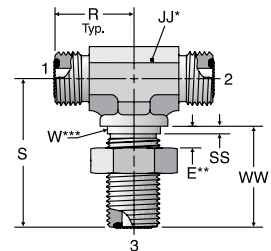


* S2 – Across Hex Flats

WJLO

Bulkhead Branch Tee
ORFS (all three ends)

SAE 520959
WJLO-WLNL - Body with Locknut
(See page A11 for WLNL)



TUBE FITTING PART #	END SIZE		L7 (mm)	S2 (mm)	Dynamic Pressure (x 1,000 PSI)	
	1-3				S	SS
	(mm)	(in.)				
4JMLO	6	1/4	21.5	14	9.2	9.2
6JMLO	8,10	3/8	25.0	19	9.2	9.2
8JMLO	12	1/2	28.0	19	9.2	9.2
10JMLO	14,15,16	5/8	33.5	27	6.0	6.0
12JMLO	18,20	3/4	37.5	30	6.0	6.0
16JMLO	22,25	1	41.5	36	6.0	6.0
20JMLO	28,30,32	1 1/4	44.5	41	5.0	5.0
24JMLO	35,38	1 1/2	49.0	50	4.0	4.0

TUBE FITTING PART #	END SIZE 1-3 (in.)	E MAX (in.)	JJ (in.)	R (in.)	S (in.)	SS (in.)	W DIA (in.)	WW (in.)	Dynamic Pressure (x 1,000 PSI)	
									-S	-SS
									4 WJLO	1/4
6 WJLO	3/8	0.55	3/4	1.02	2.05	0.06	0.69	1.34	9.2	9.2
8 WJLO	1/2	0.55	3/4	1.14	2.19	0.06	0.81	1.44	9.2	9.2
10 WJLO	5/8	0.55	1 1/16	1.36	2.48	0.06	1.00	1.59	6.0	6.0
12 WJLO	3/4	0.55	1 3/16	1.52	2.64	0.06	1.19	1.63	6.0	6.0
16 WJLO	1	0.55	1 7/16	1.67	2.80	0.06	1.44	1.65	6.0	6.0

* JJ – Across wrench flats.

** E – Maximum bulkhead thickness.

*** W – Bulkhead pilot diameter. Recommended clearance hole is W + 0.015".

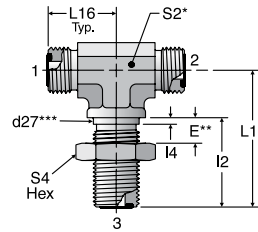
Dimensions and pressures for reference only, subject to change.



WJMLO

Bulkhead Union Tee – mm Hex
ORFS (all three ends)

ISO 8434-3 BHBT
SAE 52M0959
WJMLOWLNML - Body with Locknut
(See page A11 for WLNML)



A

TABLE OF CONTENTS

VISUAL INDEX

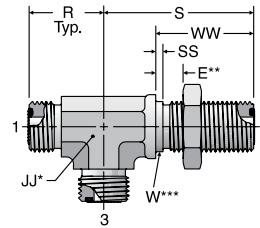
TUBE FITTING PART #	END SIZE		d27*** (mm)	E (mm)	I2 (mm)	I4 (mm)	L16 (mm)	L17 (mm)	S2 (mm)	S4 HEX (mm)	Dynamic Pressure (x 1,000 PSI)	
	1-3										S	SS
	(mm)	(in.)										
4WJMLO	6	1/4	14.3	14	31.5	1.5	22.5	47.0	14	22	9.2	9.2
6WJMLO	8,10	3/8	17.5	14	34.0	1.5	26.0	52.0	19	27	9.2	9.2
8WJMLO	12	1/2	20.6	14	36.5	2.5	29.0	55.5	19	30	9.2	9.2
10WJMLO	14,15,16	5/8	25.4	14	40.5	2.5	34.5	63.0	27	36	6.0	6.0
12WJMLO	18,20	3/4	30.2	14	41.5	3.0	38.5	67.0	30	41	6.0	6.0
16WJMLO	22,25	1	36.5	14	42.0	3.0	42.5	71.0	36	46	6.0	6.0
20WJMLO	28,30,32	1 1/4	42.9	14	42.0	3.0	45.5	75.5	41	50	5.0	5.0
24WJMLO	35,38	1 1/2	50.8	14	42.0	3.0	49.5	79.5	50	60	4.0	4.0

* S2 – Across wrench flats.
** E – Maximum bulkhead thickness.
***d27 - Bulkhead pilot diameter. Recommended clearance hole is d27 + 0.4 mm.

WJJLO

Bulkhead Run Tee
ORFS (all three ends)

SAE 520958
WJJLOWLNML - Body with Locknut
(See page A11 for WLNML)



TUBE FITTING PART #	END SIZE	E MAX (in.)	JJ (in.)	R (in.)	S (in.)	SS (in.)	W DIA (in.)	WW (in.)	Dynamic Pressure (x 1,000 PSI)	
									-S	-SS
4 WJJLO	1/4	0.55	9/16	0.89	1.85	0.06	0.56	1.24	9.2	9.2
6 WJJLO	3/8	0.55	3/4	1.02	2.05	0.06	0.69	1.34	9.2	9.2
8 WJJLO	1/2	0.55	3/4	1.14	2.19	0.06	0.81	1.44	9.2	9.2
10 WJJLO	5/8	0.55	1 1/16	1.36	2.48	0.06	1.00	1.59	6.0	6.0
12 WJJLO	3/4	0.55	1 3/16	1.52	2.64	0.06	1.19	1.63	6.0	6.0
16 WJJLO	1	0.55	1 7/16	1.67	2.80	0.06	1.44	1.65	6.0	6.0
20 WJJLO	1 1/4	0.55	1 5/8	1.79	2.79	0.06	1.69	1.65	5.0	5.0
24 WJJLO	1 1/2	0.55	1 7/8	1.95	3.13	0.06	2.00	1.65	4.0	4.0

* JJ – Across wrench flats.
** E – Maximum bulkhead thickness.
*** W – Bulkhead pilot diameter. Recommended clearance hole is W + 0.015".

Dimensions and pressures for reference only, subject to change.



WJJMLO

Bulkhead Run Tee – mm Hex
ORFS (all three ends)

ISO 8434-3 BHRT
SAE 52M0958
WJJMLOWLNML - Body with Locknut
(See page A11 for WLNML)

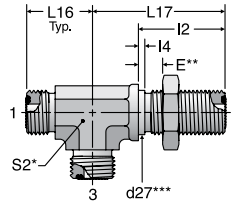


TABLE
OF
CONTENTS

VISUAL
INDEX

TUBE FITTING PART #	END SIZE		d27*** (mm)	E (mm)	I2 (mm)	I4 (mm)	L16 (mm)	L17 (mm)	S2 (mm)	Dynamic Pressure (x 1,000 PSI)	
	1-3									S	SS
	(mm)	(in.)									
4WJJMLO	6	1/4	14.3	14	31.5	1.5	22.5	47.0	14	9.2	9.2
6WJJMLO	8,10	3/8	17.5	14	34.0	1.5	26.0	52.0	19	9.2	9.2
8WJJMLO	12	1/2	20.6	14	36.5	2.5	29.0	55.5	19	9.2	9.2
10WJJMLO	14,15,16	5/8	25.4	14	40.5	2.5	34.5	63.0	27	6.0	6.0
12WJJMLO	18,20	3/4	30.2	14	41.5	3.0	38.5	67.0	30	6.0	6.0
16WJJMLO	22,25	1	36.5	14	42.0	3.0	42.5	71.0	36	6.0	6.0
20WJJMLO	28,30,32	1 1/4	42.9	14	42.0	3.0	45.5	71.0	41	5.0	5.0
24WJJMLO	35,38	1 1/2	50.8	14	42.0	3.0	49.5	79.5	50	4.0	4.0

* S2 – Across wrench flats.

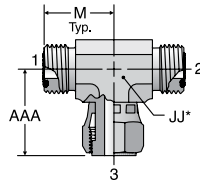
** E – Maximum bulkhead thickness.

***d27 - Bulkhead pilot diameter. Recommended clearance hole is d27 + 0.4 mm.

S6LO

Swivel Nut Branch Tee
ORFS / ORFS / ORFS Swivel

SAE 520433

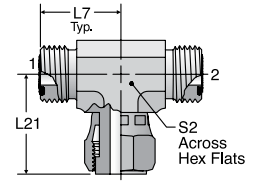


* JJ – Across Wrench Flats

S6MLO

Swivel Nut Branch Tee – mm Hex
ORFS / ORFS / ORFS Swivel

ISO 8434-3 SWBT
SAE 52M0433



* S2 – Across Wrench Flats

TUBE FITTING PART #	END SIZE		AAA (in.)	JJ (in.)	M (in.)	Dynamic Pressure (x 1,000 PSI)	
	1-3					-S	-SS
	(in.)	(in.)					
4 S6LO	1/4	1.07	9/16	0.85	9.2	9.2	
6 S6LO	3/8	1.17	3/4	0.98	9.2	9.2	
8 S6LO	1/2	1.50	3/4	1.10	9.2	9.2	
10 S6LO	5/8	1.61	1 1/16	1.32	6.0	6.0	
12 S6LO	3/4	1.83	1 3/16	1.48	6.0	6.0	
16 S6LO	1	2.11	1 7/16	1.63	6.0	6.0	
20 S6LO	1 1/4	2.28	1 5/8	1.75	5.0	5.0	
24 S6LO	1 1/2	2.40	1 7/8	1.93	4.0	4.0	

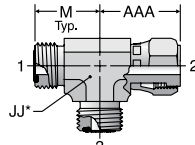
TUBE FITTING PART #	END SIZE		L7 (mm)	L21 (mm)	S2 (mm)	Dynamic Pressure (x 1,000 PSI)	
	1-3					S	SS
	(mm)	(in.)					
4S6MLO	6	1/4	21.5	27.2	14		
6S6MLO	8,10	3/8	25.0	29.7	19	9.2	9.2
8S6MLO	12	1/2	28.0	38.0	19	9.2	9.2
10S6MLO	14,15,16	5/8	33.5	41.0	27	6.0	6.0
12S6MLO	18,20	3/4	37.5	46.5	30	6.0	6.0
16S6MLO	22,25	1	41.5	53.5	36	6.0	6.0
20S6MLO	28,30,32	1 1/4	44.5	58.0	41	4.0	4.0
24S6MLO	35,38	1 1/2	49.0	61.0	50	4.0	4.0

Dimensions and pressures for reference only, subject to change.

R6LO

Swivel Nut Run Tee
ORFS / ORFS Swivel / ORFS

SAE 520432

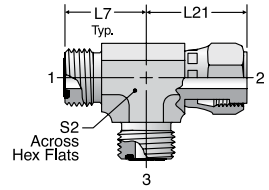


* JJ – Across
Wrench Flats

R6MLO

Swivel Nut Run Tee – mm Hex
ORFS / ORFS Swivel / ORFS

ISO 8434-3 SWRT
SAE 52M0432



A

**TABLE
OF
CONTENTS**

TUBE FITTING PART #	END SIZE		JJ (in.)	M (in.)	Dynamic Pressure (x 1,000 PSI)	
	1-3 (in.)	AAA (in.)			-S	-SS
6 R6LO	3/8	1.17	3/4	0.98	9.2	9.2
8 R6LO	1/2	1.50	3/4	1.10	9.2	9.2
10 R6LO	5/8	1.61	1 1/16	1.32	6.0	6.0
12 R6LO	3/4	1.83	1 3/16	1.48	6.0	6.0
16 R6LO	1	2.11	1 7/16	1.63	6.0	6.0
20 R6LO	1 1/4	2.28	1 5/8	1.75	5.0	5.0
24 R6LO	1 1/2	2.40	1 7/8	1.93	4.0	4.0

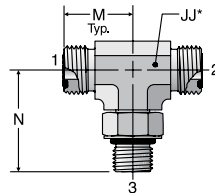
TUBE FITTING PART #	END SIZE		L7 (mm)	L21 (mm)	S2 (mm)	Dynamic Pressure (x 1,000 PSI)	
	1-3					-S	-SS
	(mm)	(in.)					
4R6MLO	6	1/4	21.5	27.2	14	9.2	9.2
6R6MLO	8,10	3/8	25.0	29.7	19	9.2	9.2
8R6MLO	12	1/2	28.0	38.0	19	9.2	9.2
10R6MLO	14,15,16	5/8	33.5	41.0	27	6.0	6.0
12R6MLO	18,20	3/4	37.5	46.5	30	6.0	6.0
16R6MLO	22,25	1	41.5	53.5	36	6.0	6.0
20R6MLO	28,30,32	1 1/4	44.5	58.0	41	4.0	4.0
24R6MLO	35,38	1 1/2	49.0	61.0	50	4.0	4.0

**VISUAL
INDEX**

S5OLO

Straight Thread Branch Tee
ORFS / ORFS / SAE-ORB

SAE 520429



* JJ – Across
Wrench Flats

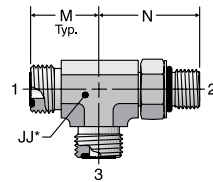
TUBE FITTING PART #	END SIZE			JJ (in.)	M (in.)	N (in.)	Dynamic Pressure (x 1,000 PSI)	
	1 (in.)	2 (in.)	3 UN/UNF-2A				-S	-SS
4-4-6 S5OLO	1/4	1/4	9/16 - 18	9/16	0.93	1.46	6.0	6.0
6 S5OLO	3/8	3/8	9/16 - 18	3/4	0.98	1.46	6.0	6.0
6-6-4 S5OLO	3/8	3/8	7/16 - 20	3/4	0.98	1.38	6.0	6.0
6-6-8 S5OLO	3/8	3/8	3/4 - 16	3/4	1.04	1.59	6.0	6.0
8 S5OLO	1/2	1/2	3/4 - 16	3/4	1.10	1.59	6.0	6.0
8-8-10 S5OLO	1/2	1/2	7/8 - 14	1 1/16	1.24	1.97	6.0	6.0
8-8-12 S5OLO	1/2	1/2	1 1/16 - 12	1 3/16	1.34	2.17	6.0	6.0
10 S5OLO	5/8	5/8	7/8 - 14	1 1/16	1.32	1.97	6.0	6.0
10-10-12 S5OLO	5/8	5/8	1 1/16 - 12	1 3/16	1.42	2.17	6.0	6.0
12 S5OLO	3/4	3/4	1 1/16 - 12	1 3/16	1.48	2.17	6.0	6.0
12-12-16 S5OLO	3/4	3/4	1 5/16 - 12	1 7/16	1.61	2.34	5.5	5.5
16 S5OLO	1	1	1 5/16 - 12	1 7/16	1.63	2.34	5.5	5.5
16-16-20 S5OLO	1	1	1 5/8 - 12	1 5/8	1.75	2.44	4.0	4.0
20 S5OLO	1 1/4	1 1/4	1 5/8 - 12	1 5/8	1.75	2.44	4.0	4.0
24 S5OLO	1 1/2	1 1/2	1 7/8 - 12	1 7/8	1.93	2.60	4.0	4.0

Dimensions and pressures for reference only, subject to change.

R5OLO

Straight Thread Run Tee
ORFS / SAE-ORB / ORFS

SAE 520428

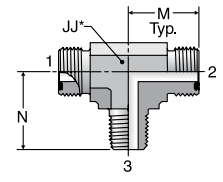


* JJ – Across
Wrench Flats

SLO

Male Pipe Tee
ORFS / ORFS / NPTF

SAE 520425



* JJ – Across
Wrench Flats

TABLE
OF
CONTENTS

TUBE FITTING PART #	END SIZE			JJ (in.)	M (in.)	N (in.)	Dynamic Pressure (x 1,000 PSI)	
	1	2	3				-S	-SS
	(in.)	UN/UNF-2A	(in.)					
4 R5OLO	1/4	7/16 - 20	1/4	9/16	0.85	1.30	6.0	6.0
4-6-4 R5OLO	1/4	9/16 - 18	1/4	3/4	0.92	1.46	6.0	6.0
6 R5OLO	3/8	9/16 - 18	3/8	3/4	0.98	1.46	6.0	6.0
6-8-6 R5OLO	3/8	3/4 - 16	3/8	3/4	1.04	1.59	6.0	6.0
8 R5OLO	1/2	3/4 - 16	1/2	3/4	1.10	1.59	6.0	6.0
8-10-8 R5OLO	1/2	7/8 - 14	1/2	1 1/16	1.24	1.97	6.0	6.0
10 R5OLO	5/8	7/8 - 14	5/8	1 1/16	1.32	1.97	6.0	6.0
10-12-10 R5OLO	5/8	1 1/16 - 12	5/8	1 3/16	1.42	2.17	6.0	6.0
12 R5OLO	3/4	1 1/16 - 12	3/4	1 3/16	1.48	2.17	6.0	6.0
12-16-12 R5OLO	3/4	1 5/16 - 12	3/4	1 7/16	1.61	2.34	5.5	5.5
16 R5OLO	1	1 5/16 - 12	1	1 7/16	1.63	2.34	5.5	5.5
16-20-16 R5OLO	1	1 5/8 - 12	1	1 5/8	1.75	2.44	4.0	4.0
20 R5OLO	1 1/4	1 5/8 - 12	1 1/4	1 5/8	1.75	2.44	4.0	4.0
24 R5OLO	1 1/2	1 7/8 - 12	1 1/2	1 7/8	1.93	2.60	4.0	4.0

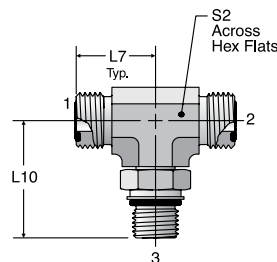
TUBE FITTING PART #	END SIZE		JJ (in.)	M (in.)	N (in.)	Dynamic Pressure (x 1,000 PSI)	
	1 & 2	3				-S	-SS
	(in.)	NPTF					
4-4-4 SLO	1/4	1/4 - 18	9/16	0.85	1.12	6.0	6.0
6 SLO	3/8	1/4 - 18	3/4	0.98	1.09	6.0	6.0
6-6-6 SLO	3/8	3/8 - 18	3/4	0.98	1.22	6.0	6.0
8 SLO	1/2	3/8 - 18	3/4	1.10	1.22	6.0	6.0
8-8-8 SLO	1/2	1/2 - 14	7/8	1.10	1.47	6.0	6.0
10 SLO	5/8	1/2 - 14	1 1/16	1.31	1.47	6.0	6.0
12 SLO	3/4	3/4 - 14	1 3/16	1.47	1.59	4.0	4.0
16 SLO	1	1 - 11 1/2	1 7/16	1.64	1.97	3.0	3.0
20 SLO	1 1/4	1 1/4 - 11 1/2	1 5/8	1.76	2.38	2.5	2.5

VISUAL
INDEX

S87OMLO

Metric Straight Thread Branch Tee
ORFS / ORFS / ISO 6149

ISO 8434-3 SDBT
SAE 52M0489



* S2 – Across
Hex Flats

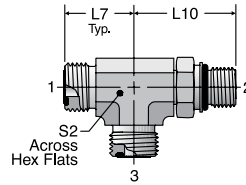
TUBE FITTING PART #	END SIZE			L7 (mm)	L10 (mm)	S2 (mm)	Dynamic Pressure (x 1,000 PSI)	
	1 & 2	3	S				SS	
	(mm)	(in.)						ISO 261
4M12S87OMLO	6	1/4	M12X1.5	21.5	33.0	14	6.0	6.0
4M14S87OMLO	6	1/4	M14X1.5	23.5	35.5	19	6.0	6.0
6M14S87OMLO	8,10	3/8	M14X1.5	25.0	35.5	19	6.0	6.0
6M16S87OMLO	8,10	3/8	M16X1.5	25.0	37.5	19	6.0	6.0
8M14S87OMLO	12	1/2	M14X1.5	28.0	36.0	19	6.0	6.0
8M18S87OMLO	12	1/2	M18X1.5	28.0	41.0	19	6.0	6.0
8M22S87OMLO	12	1/2	M22X1.5	31.0	49.0	27	6.0	6.0
10M22S87OMLO	14,15,16	5/8	M22X1.5	33.5	49.0	27	6.0	6.0
12M27S87OMLO	18,20	3/4	M27X2	37.5	55.5	30	6.0	6.0
16M33S87OMLO	22,25	1	M33X2	41.5	59.5	36	5.1	5.1
20M42S87OMLO	28,30,32	1 1/4	M42X2	44.5	63.0	41	4.0	4.0
24M48S87OMLO	35,38	1 1/2	M48X2	49.0	71.5	50	4.0	4.0

Dimensions and pressures for reference only, subject to change.

R87OMLO

Metric Straight Thread Run Tee
ORFS / ISO 6149 / ORFS

ISO 8434-3 SDRT
SAE 52M0488



A

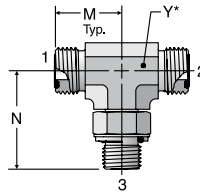
TABLE OF CONTENTS

VISUAL INDEX

TUBE FITTING PART #	END SIZE			L7 (mm)	L10 (mm)	S2 (mm)	Dynamic Pressure (x 1,000 PSI)	
	1 & 3		2				S	SS
	(mm)	(in.)	ISO 261					
4M12R87OMLO	6	1/4	M12X1.5	21.5	33.0	14	6.0	6.0
4M14R87OMLO	6	1/4	M14X1.5	23.5	35.5	19	6.0	6.0
6M14R87OMLO	8,10	3/8	M14X1.5	25.0	35.5	19	6.0	6.0
6M16R87OMLO	8,10	3/8	M16X1.5	25.0	37.5	19	6.0	6.0
8M14R87OMLO	12	1/2	M14X1.5	28.0	36.0	19	6.0	6.0
8M18R87OMLO	12	1/2	M18X1.5	28.0	41.0	19	6.0	6.0
8M22R87OMLO	12	1/2	M22X1.5	31.0	49.0	27	6.0	6.0
10M22R87OMLO	14,15,16	5/8	M22X1.5	33.5	49.0	27	6.0	6.0
12M27R87OMLO	18,20	3/4	M27X2	37.5	55.5	30	6.0	6.0
16M33R87OMLO	22,25	1	M33X2	41.5	59.5	36	4.0	4.0
20M42R87OMLO	28,30,32	1 1/4	M42X2	44.5	63.0	41	4.0	4.0
24M48R87OMLO	35,38	1 1/2	M48X2	49.0	71.5	50	4.0	4.0

S4OMLO

Branch Tee – BSPP
(for ISO 1179-1 Port)
ORFS / ORFS / BSPP-ORR



*Y – Across Wrench Flats

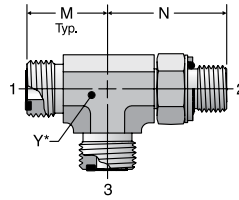
TUBE FITTING PART #	END SIZE			M (mm)	N (mm)	Y (mm)	Dynamic Pressure (x 1,000 PSI)	
	1 & 2		3				S	SS
	(mm)	(in.)	BSPP					
4S4OMLO	6	1/4	1/8 - 28	21.5	30.0	14	4.0	4.0
4-4-4S4OMLO	6	1/4	1/4 - 19	23.5	36.0	19	4.0	4.0
6S4OMLO	8,10	3/8	1/4 - 19	25.0	36.0	19	4.0	4.0
6-6-6S4OMLO	8,10	3/8	3/8 - 19	26.5	38.0	19	4.0	4.0
8S4OMLO	12	1/2	3/8 - 19	28.0	38.0	19	4.0	4.0
8-8-8S4OMLO	12	1/2	1/2 - 14	31.0	48.5	27	4.0	4.0
10S4OMLO	14,15,16	5/8	1/2 - 14	33.5	48.5	27	4.0	4.0
12S4OMLO	18,20	3/4	3/4 - 14	37.5	51.5	30	4.0	4.0
16S4OMLO	22,25	1	1 - 11	41.5	58.5	36	4.0	4.0

Dimensions and pressures for reference only, subject to change.



R4OMLO

Run Tee – BSPP
 (for ISO 1179-1 Port)
 ORFS / BSPP-ORR / ORFS



* Y – Across
 Wrench Flats

TABLE
 OF
 CONTENTS

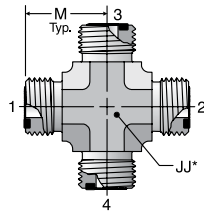
VISUAL
 INDEX

TUBE FITTING PART #	END SIZE			M (mm)	N (mm)	Y (mm)	Dynamic Pressure (x 1,000 PSI)	
	1 & 3		2				S	SS
	(mm)	(in.)	BSPP					
4R4OMLO	6	1/4	1/8 - 28	21.5	30.0	14	4.0	4.0
4-4-4R4OMLO	6	1/4	1/4 - 19	23.5	36.0	19	4.0	4.0
6R4OMLO	8,10	3/8	1/4 - 19	25.0	36.0	19	4.0	4.0
6-6-6R4OMLO	8,10	3/8	3/8 - 19	26.5	38.0	19	4.0	4.0
8R4OMLO	12	1/2	3/8 - 19	28.0	38.0	19	4.0	4.0
8-8-8R4OMLO	12	1/2	1/2 - 14	31.0	48.5	27	4.0	4.0
10R4OMLO	14,15,16	5/8	1/2 - 14	33.5	45.2	27	4.0	4.0
12R4OMLO	18,20	3/4	3/4 - 14	37.5	51.5	30	4.0	4.0
16R4OMLO	22,25	1	1 - 11	41.5	58.5	37	4.0	4.0

KLO

Union Cross
 ORFS (all four ends)

SAE 520501



* JJ – Across
 Wrench Flats

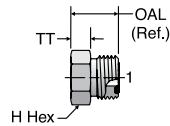
TUBE FITTING PART #	END SIZE	JJ (in.)	M (in.)	Dynamic Pressure (x 1,000 PSI)	
	1-4 (in.)			-S	-SS
4 KLO	1/4	9/16	0.85	9.2	9.2
6 KLO	3/8	3/4	0.98	9.2	9.2
8 KLO	1/2	3/4	1.10	9.2	9.2
10 KLO	5/8	1 1/16	1.32	6.0	6.0
12 KLO	3/4	1 3/16	1.48	6.0	6.0
16 KLO	1	1 5/8	1.63	6.0	6.0
20 KLO	1 1/4	1 5/8	1.75	5.0	5.0
24 KLO					

Dimensions and pressures for reference only, subject to change.

PNLO

Plug
ORFS

SAE 520109



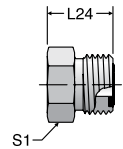
TUBE FITTING PART #	END SIZE	H HEX (in.)	OAL (REF) (in.)	TT (in.)	Dynamic Pressure (x 1,000 PSI)	
					-S	-SS
					1 (in.)	5/8
6 PNLO	3/8	3/4	0.75	0.32	9.2	9.2
8 PNLO	1/2	7/8	0.87	0.35	9.2	9.2
10 PNLO	5/8	1 1/16	1.02	0.41	6.0	6.0
12 PNLO	3/4	1 1/4	1.08	0.41	6.0	6.0
14 PNLO*	7/8	1 3/8	1.10	0.49	6.0	6.0
16 PNLO	1	1 1/2	1.10	0.41	6.0	6.0
20 PNLO	1 1/4	1 3/4	1.10	0.41	6.0	6.0
24 PNLO	1 1/2	2 1/8	1.10	0.41	5.0	5.0
32 PNLO*	2	2 3/4	1.40	0.50	3.0	3.0

* Sizes 14 and 32 are not included in SAE J1453.

PNMLO

Plug – mm Hex
ORFS

ISO 8434-3 PL
SAE 52M0109



TUBE FITTING PART #	ORFS TUBE O.D.		L24 (mm)	S1 HEX (mm)	Dynamic Pressure (x 1,000 PSI)	
	(mm)	(in.)			S	SS
	4PNMLO	6			1/4	16.5
6PNMLO	8,10	3/8	19.0	19	9.2	9.2
8PNMLO	12	1/2	22.0	22	9.2	9.2
10PNMLO	14,15,16	5/8	26.0	27	6.0	6.0
12PNMLO	18,20	3/4	27.5	32	6.0	6.0
16PNMLO	22,25	1	28.0	41	6.0	6.0
20PNMLO	28,30,32	1 1/4	28.0	46	6.0	6.0
24PNMLO	38	1 1/2	28.0	55	5.0	5.0

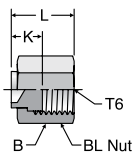
TABLE OF CONTENTS

VISUAL INDEX

FNL

Cap
ORFS

SAE 520112

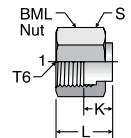


TUBE FITTING PART #	TUBE O.D. (in.)	T6 SWIVEL UN/UNF-2B	B HEX (in.)	K (in.)	L (in.)	Dynamic Pressure (x 1,000 PSI)	
						-S	-SS
						4 FNL	1/4
6 FNL	3/8	11/16 - 16	13/16	0.41	0.74	9.2	9.2
8 FNL	1/2	13/16 - 16	15/16	0.47	0.87	9.2	9.2
10 FNL	5/8	1 - 14	1 1/8	0.53	1.02	6.0	6.0
12 FNL	3/4	1 3/16 - 12	1 3/8	0.59	1.12	6.0	6.0
14 FNL*	7/8	1 5/16 - 12	1 1/2	0.59	1.12	6.0	6.0
16 FNL	1	1 7/16 - 12	1 5/8	0.63	1.16	6.0	6.0
20 FNL	1 1/4	1 11/16 - 12	1 7/8	0.63	1.16	6.0	6.0
24 FNL	1 1/2	2 - 12	2 1/4	0.63	1.16	5.0	5.0
32 FNL*	2	2 1/2 - 12	2 7/8	0.79	1.46	3.0	3.0

* Sizes 14 and 32 are not included in SAE J1453.

FNML

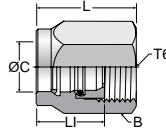
Cap
ORFS



TUBE FITTING PART #	TUBE O.D.		T6 SWIVEL UN/UNF-2B	K (mm)	L (mm)	S HEX (mm)	Dynamic Pressure (x 1,000 PSI)	
	(mm)	(in.)					S	SS
	4FNML	6					1/4	9/16 - 18
6FNML	8, 10	3/8	11/16 - 16	10.5	18.8	22	9.2	9.2
8FNML	12	1/2	13/16 - 16	12.0	22.0	24	9.2	9.2
10FNML	14, 15, 16	5/8	1 - 14	13.5	26.0	30	6.0	6.0
12FNML	18, 20	3/4	1 3/16 - 12	15.0	28.6	36	6.0	6.0
16FNML	22, 25	1	1 7/16 - 12	16.0	29.5	41	6.0	6.0
20FNML	28, 30, 32	1 1/4	1 11/16 - 12	16.0	29.5	50	6.0	6.0
24FNML	35, 38	1 1/2	2 - 12	16.0	29.5	60	5.0	5.0

Dimensions and pressures for reference only, subject to change.

UPTC Nut Assembly



TUBE FITTING PART #	END SIZE (in.)	T6 UN/UNF-2B	B HEX (in.)	L (in.)	L1 (in.)	C	
						Nominal Nipple Size	
						(in.)	(mm)
4 UPTCL	1/4	9/16-18	11/16	0.97	0.68	0.31	8
6 UPTCL	3/8	11/16-16	13/16	1.06	0.74	0.47	12
8 UPTCL	1/2	13/16-16	15/16	1.19	0.81	0.59	15
10 UPTCL	5/8	1-14	1 1/8	1.34	0.87	0.71	18
12 UPTCL	3/4	1 3/16-12	1 3/8	1.38	0.86	0.87	22
16 UPTCL	1	1 7/16-12	1 5/8	1.48	0.94	0.98	25

To order as pre-torqued assembly on standard Seal-Lok adapters, see page A7.

TABLE
OF
CONTENTS

VISUAL
INDEX

Dimensions and pressures for reference only, subject to change.



TABLE
OF
CONTENTS

VISUAL
INDEX








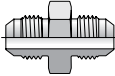
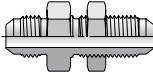
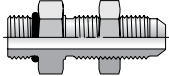
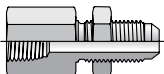
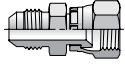
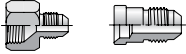

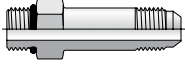
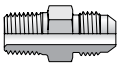

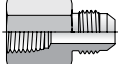





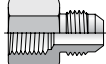
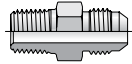

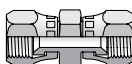
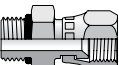

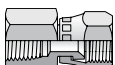


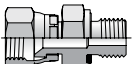


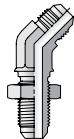
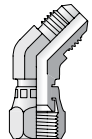
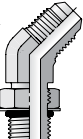
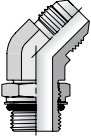
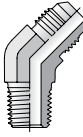
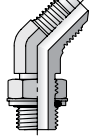
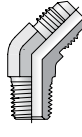
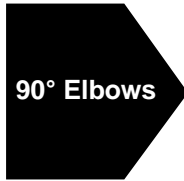
Triple-Lok™ & Triple-Lok™ 2 37° Flare Tube Fittings

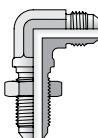
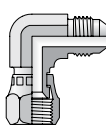
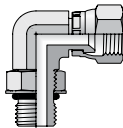
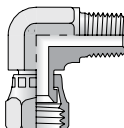
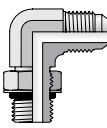
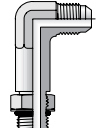
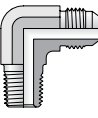
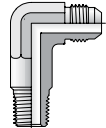
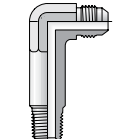
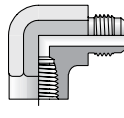
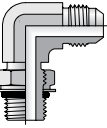
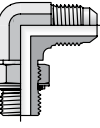
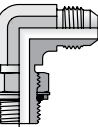
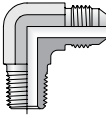

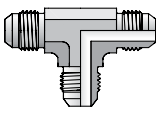
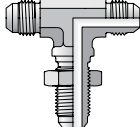
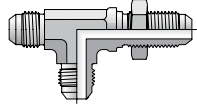
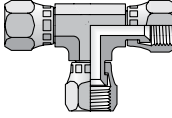
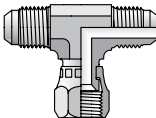
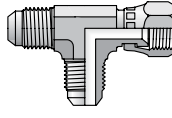
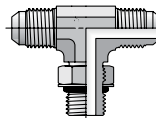
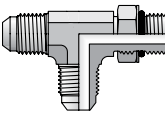
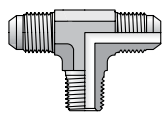
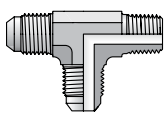
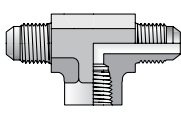
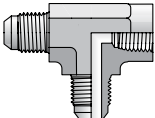
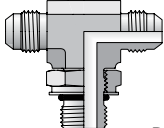
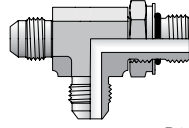
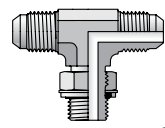
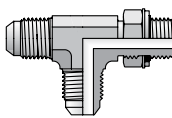
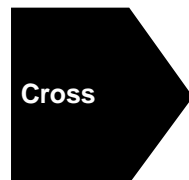

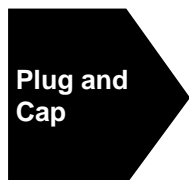



B



ENGINEERING YOUR SUCCESS.

TABLE
 OF
 CONTENTS


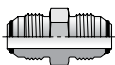



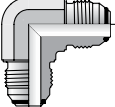
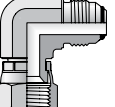
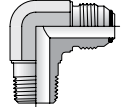
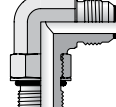
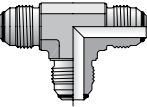
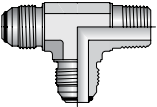
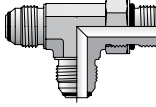
 <p>Nuts, Sleeves, Locknuts</p>	<p>BTX Nut</p>  <p>B9</p>	<p>TX and TX Metric Sleeve</p>  <p>B9</p>	<p>WLN Bulkhead Locknut</p>  <p>B10</p>	<p>SBR Braze Ring</p>  <p>B10</p>	
	 <p>Straights</p>	<p>HTX Union</p>  <p>B10</p>	<p>LHTX Large Hex Union</p>  <p>B10</p>	<p>WTX Bulkhead Union</p>  <p>B11</p>	<p>WF50X SAE-ORB / 37° Bulkhead</p>  <p>B11</p>
<p>WGTX NPTF / 37° Bulkhead</p>  <p>B12</p>		<p>XXH6 Extender and Expander</p>  <p>B12</p>	<p>TRTX / TRTXN Reducer</p>  <p>B13</p>	<p>F50X SAE-ORB / 37° Flare</p>  <p>B14</p>	<p>FF50X SAE-ORB / 37° – Long</p>  <p>B14</p>
<p>FTX NPTF / 37° Flare</p>  <p>B15</p>	<p>FFTX NPTF / 37° Flare – Long</p>  <p>B15</p>	<p>GTX NPTF / 37° Flare</p>  <p>B15</p>	<p>F870MX ISO 6149 / 37° Flare</p>  <p>B16</p>	<p>F82EDMX Metric-ED / 37° Flare</p>  <p>B16</p>	<p>F80MX Metric-ORR / 37° Flare</p>  <p>B16</p>
<p>F42EDMX BSPP-ED / 37° Flare</p>  <p>B16</p>	<p>F40MX BSPP-ORR / 37° Flare</p>  <p>B17</p>	<p>G4MX BSPP / 37° Flare</p>  <p>B17</p>	<p>F3MX BSPT / 37° Flare</p>  <p>B17</p>	 <p>Straight Swivels</p>	<p>HX6 37° Swivel Union</p>  <p>B17</p>
<p>F650X SAE-ORB / 37° Swivel</p>  <p>B18</p>	<p>F6X NPTF / 37° Swivel</p>  <p>B18</p>	<p>G6X NPTF / 37° Swivel</p>  <p>B18</p>	<p>F6870MX ISO-6149 / 37° Swivel</p>  <p>B18</p>		<p>F680MX Metric-ORR / 37° Swivel</p>  <p>B19</p>
<p>F642EDMX BSPP-ED / 37° Swivel</p>  <p>B19</p>	<p>F63MX BSPT / 37° Swivel</p>  <p>B19</p>	 <p>45° Elbows</p>	<p>WNTX Bulkhead Union</p>  <p>B20</p>	<p>V6X 37° Swivel Elbow</p>  <p>B20</p>	<p>V50X SAE-ORB / 37° Flare</p>  <p>B20</p>
<p>V870MX ISO-6149 / 37° Flare</p>  <p>B20</p>	<p>VTX NPTF / 37° Flare</p>  <p>B21</p>		<p>V40MX BSPP-ORR / 37° Flare</p>  <p>B21</p>	<p>V3MX BSPT / 37° Flare</p>  <p>B21</p>	 <p>90° Elbows</p>

WETX Bulkhead Union  B22	C6X 37° Swivel Elbow  B22	AOEX6 SAE-ORB / 37° Swivel  B22	X6EF NPTF / 37° Swivel  B23	C50X SAE-ORB / 37° Flare  B23	CC50X SAE-ORB / 37° – Long  B23
CTX NPTF / 37° Flare  B24	CCTX NPTF / 37° Flare – Long  B24	CCCTX NPTF / 37° – Extra Long  B24	DTX NPTF / 37° Flare  B25	C870MX ISO-6149 / 37° Flare  B25	C80MX Metric-ORR / 37° Flare  B25
C40MX BSPP-ORR / 37° Flare  B26	C3MX BSPT / 37° Flare  B26		JTX Union Tee  B26	WJTX Bulkhead Branch Tee  B27	WJJTX Bulkhead Run Tee  B27
JX6 37° Swivel Union Tee  B28	S6X 37° Swivel Branch Tee  B28	R6X 37° Swivel Run Tee  B28	S50X SAE-ORB Branch Tee  B29	R50X SAE-ORB Run Tee  B29	STX NPTF Branch Tee  B30
RTX NPTF Run Tee  B30	OTX NPTF Branch Tee  B30	MTX NPTF Run Tee  B30	S870MX ISO 6149 Branch Tee  B31	R870MX ISO 6149 Run Tee  B31	S40MX BSPP-ORR Branch Tee  B31
R40MX BSPP-ORR Run Tee  B31		KTX Union Cross  B32		PNTX 37° Plug  B32	FNTX 37° Cap  B32
T22X Mountie Cap  B32					

B




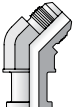
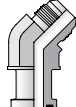


TABLE OF CONTENTS

Triple-Lok® 2 Soft Seal Flare Tube Fittings


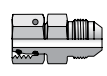
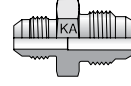
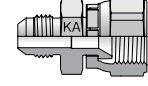
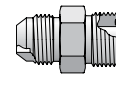
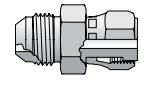
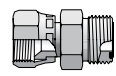
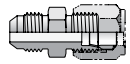
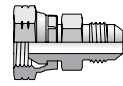
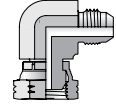
 <p>Straights</p>	<p>HTXO Union</p>  <p>B33</p>	<p>F5OXO SAE-ORB / 37° Flare</p>  <p>B33</p>	<p>FTXO NPTF / 37° Flare</p>  <p>B33</p>	<p>GTXO NPTF / 37° Flare</p>  <p>B33</p>
	<p>ETXO Union Elbow</p>  <p>B34</p>	<p>C6XO 37° Swivel Elbow</p>  <p>B34</p>	<p>CTXO NPTF / 37° Flare</p>  <p>B34</p>	<p>C5OXO SAE-ORB / 37° Flare</p>  <p>B34</p>
	<p>JTXO Union Tee</p>  <p>B35</p>	<p>RTXO 37° Swivel Run Tee</p>  <p>B35</p>	<p>R5OXO SAE-ORB Run Tee</p>  <p>B35</p>	

**TABLE
 OF
 CONTENTS**

Flange Adapters (Shown in Section L)


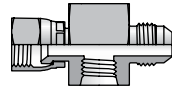

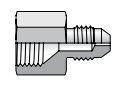
 <p>SAE Flange Adapters</p>	<p>XHQ1 Code 61 / 37° Flare</p>  <p>L12</p>	<p>XHQ2 Code 62 / 37° Flare</p>  <p>L12</p>	<p>XVQ1 Code 61 / 37° Flare</p>  <p>L30</p>	<p>XVQ2 Code 62 / 37° Flare</p>  <p>L30</p>	<p>XEQ1 Code 61 / 37° Flare</p>  <p>L31</p>
	<p>XEQ2 Code 62 / 37° Flare</p>  <p>L31</p>				

Conversion Adapters (Shown in Sections J and K)


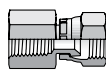
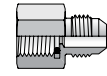
	XHU86 Metric Swivel (EO) / 37°  K6	XHMKA Komatsu 30° / 37° Flare  J5	XHMKA6 Komatsu 30° Swivel / 37°  J5	XHLO 37° Flare / ORFS  K3	XHL6 37° Flare / ORFS Swivel  K3
	LOHX6 ORFS / 37° Swivel  K3	XHBU 37° Flare / Flareless  K4	XHMK46 37° Flare / BSPP Swivel  K5	XEMK46 37° Flare / BSPP Swivel  K6	

B
 TABLE OF CONTENTS


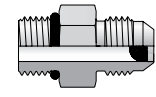
Diagnostic and Orifice Fittings (Shown in Section M)

	XHX6G5TP 37° Flare / 37° Swivel / SAE-ORB  M5		XHX7 37° Flare / 37° Female with Orifice  M9
---	--	---	---


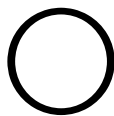
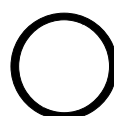
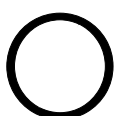
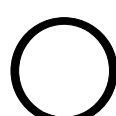
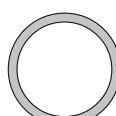
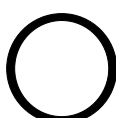


Gauge Fittings (Shown in Section M)

	G6X NPT Gauge / 37° Swivel  M7	G4MXSMO BSPP Gauge / 37° Flare  M6
---	---	---

Screen Fittings (Shown in Section M)

	Screen Fittings  M12
--	---

O-Rings and Seals (Shown in Section N)

	XO O-Ring  N4	SAE O-Ring  N4	ISO 6149 O-Ring  N5	Metric O-Ring  N5	Metric Retaining Ring  N5
	BSPP O-Ring  N6	BSPP Retaining Ring  N6	EOLastic Seal Ring  N6		

Triple-Lok

Parker Triple-Lok fittings meet the strict requirements of SAE J514 and ISO 8434-2 industry standards for 37° flare fittings. Its design is simple. It uses an easily produced flare at the tube end to seal and hold fluid under high pressure. The fitting consists of three pieces: the body, sleeve and nut. The tube is flared at a 37° angle (74° included angle) and held between the fitting nose (seat) and the sleeve (support) with the nut as shown in Fig. B1, providing a very effective seal between the fitting nose and the tube flare.

The design of Triple-Lok fittings is very efficient. The fitting incorporates the smallest seal area of all fitting types. This seal area, as seen in Fig. B1, is only slightly larger than the fluid flow area. The small seal area results in a compact design, low assembly torque, and a relatively high-pressure capability.

How Triple-Lok Fittings Work

Tightening of the nut clamps the tube flare between the body nose (seat) producing a leak tight connection. This clamping on the 37° taper provides a measure of elasticity to the joint helping it to resist loosening under vibration. The clamping force results in a small radial load that tends to deform the fitting nose radially. The resistance of the nose to elastic deformation provides a constant preload (similar to a lockwasher) keeping it tight.

The clamping force provided by the nut resists the opposing force of the fluid under pressure. The joint remains leak tight as long as the clamping force is higher than the opposing pressure load. Properly assembled Triple-Lok fittings with appropriate tube will seal consistently under pressure until tube bursts.

Sealing in Triple-Lok fittings takes place between two smooth metal surfaces, the fitting nose and inside of the tube flare. Therefore, the sealing surfaces have to be smooth, free of any nicks, scratches, spiral tool marks, splits or weld beads. Seamless or welded and drawn fully annealed tube is recommended for Triple-Lok fittings for ease in flaring and bending. Certain types of harder tubes that are not fully annealed may not be suitable for flaring due to the potential for immediate or long-term cracking of the tube flare. For specific tube type and wall thickness recommendations, please see Table U3 in the Appendix Section.

International Acceptance

The versatility of 37° flare fittings is a primary reason for its worldwide acceptance. To illustrate the versatility of Triple-Lok, refer to Fig. B2. The Triple-Lok adapter is attachable to either inch tube, metric tube, or a hose assembly. To adapt to metric tube, simply change the sleeve (using the standard inch adapter and nut). Please see Table U4 in the Appendix Section for a clear illustration of every "convertible sleeve" connection for the 37° design. For example, for a 25 mm tube assembly, a standard SAE -16 (1") flare fitting and nut would be used, however, a 25 mm metric sleeve (TXS25) would replace the inch size sleeve.

Triple-Lok fittings are available with many different port options for the various international hydraulic ports available, such as SAE straight thread, NPT/NPTF, BSPP, BSPT and Metric (including ISO 6149).

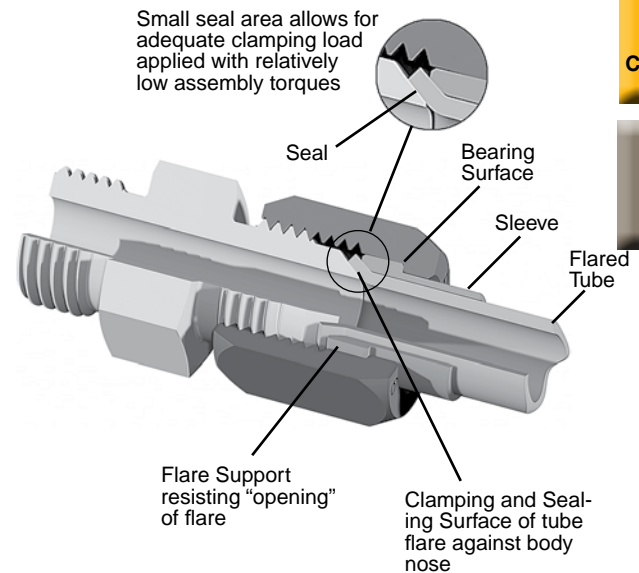


Fig. B1 – Triple-Lok Design and Features

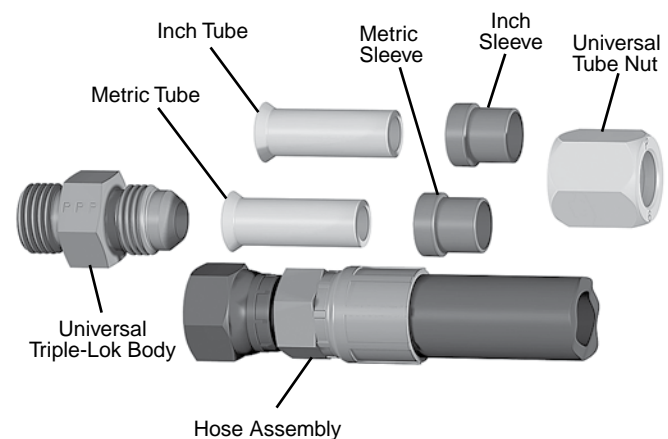


Fig. B2 – Triple-Lok's Adaptability to Inch Tube, Metric Tube, or Hose Assemblies

TABLE
 OF
 CONTENTS

VISUAL
 INDEX

Triple-Lok 2

Triple-Lok 2 combines the versatility of stainless steel Triple-Lok with the added advantage of an elastomeric seal. It incorporates an O-ring that is positioned in the nose of the 37° flare so that elastomeric sealing occurs with the mating flared tube. Similar to the standard stainless steel Triple-Lok, Triple-Lok 2 consists of three pieces: the body (with O-ring), the standard Triple-Lok sleeve and standard Triple-Lok nut. The tube end is flared at a 37° angle (74° included angle) and held between the fitting nose and sleeve with the nut as shown in Fig. B3, providing a very effective elastomeric seal between the fitting nose and the tube flare.

The Parker Advantage

Robust Port Stud: The adjustable port stud is manufactured with a longer locknut designed to cover the uppermost threads completely. Since the backup washer is never exposed to the upper threads, it cannot be damaged during assembly. During assembly, exposed upper threads, as common with fittings from other fitting manufacturers, can lead to a deformed backup washer that can pinch the o-ring and create an o-ring extrusion gap that has the potential to leak. The longer locknut also provides a greater grip area for the wrench.

Superior Plating: Superior plating gives Parker steel tube fittings unmatched protection against red rust. In neutral salt spray test per ASTM B117, Parker Triple-Lok fittings substantially exceeded the SAE requirement of 96 hours to red rust.

Pre-Lubricated Stainless Steel Tube Nut: All stainless steel Triple-Lok tube nuts have a pre-applied anti-seize lubricant to prevent galling during assembly.

Triple-Lok 2: Triple-Lok 2 utilizes an elastomeric seal in the flare nose for improved seal reliability in applications where stainless steel fittings are required.

Wide Selection: Triple-Lok fittings are available as standard in steel, stainless steel, brass and aluminum materials. Coupled with its broad line of configurations and port end options, Parker is well positioned to better service the hydraulic requirements of the international markets.

Reference locations

Dynamic Pressure Ratings: Please refer to the last column of the part number tables located on the following pages of this section for the appropriate dynamic pressure ratings.

Recommended Tube Wall Thickness: Please refer to Table U3 located in the Appendix section.

Assembly and Installation: Please refer to Triple-Lok Assembly located within the Assembly/Installation section of this catalog.

Standard material specifications: Please refer to Table U1 located in the Appendix section.

Seal Material Selection: Please refer to Table T8 in the General Technical section of this catalog.

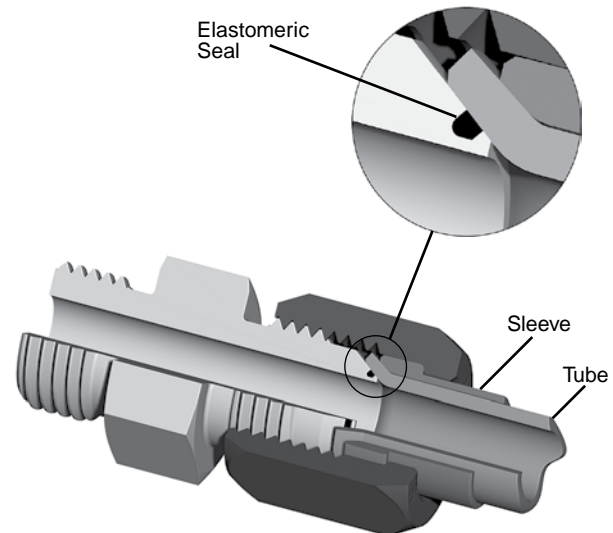
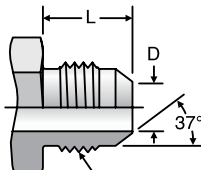


Fig. B3 – Triple-Lok 2 Design and Features

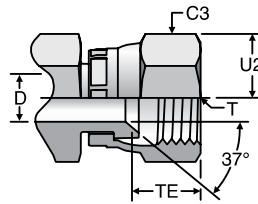


Dimensions and pressures for reference only, subject to change.

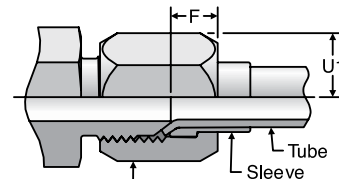
Triple-Lok 37° Flared Tube Ends



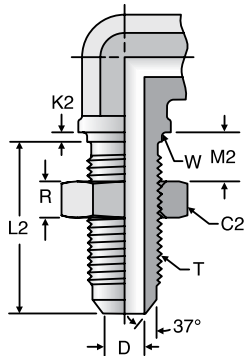
Triple-Lok Male Flare Tube End



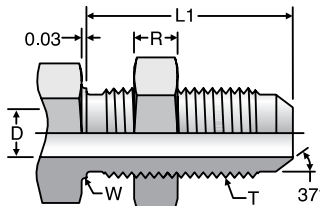
Triple-Lok Swivel



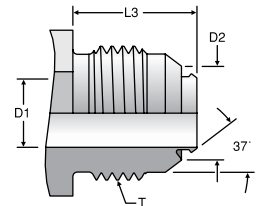
Triple-Lok Tube End Assembly



Triple-Lok Shape Bulkhead



Triple-Lok Straight Bulkhead



Triple-Lok 2 Male Flare Tube End

TABLE OF CONTENTS

VISUAL INDEX

SAE Dash Size	Tube O.D.		T	C	C2	C3	D	D1	L	L3	F	TE	K2	L1	L2	R	W ¹⁾	Max Bulkhead Thickness		Min. Flare Dia.	
																		Straight	Shapes		
																					Bulkhead
Thread	Tube Nut Hex	Bulkhead Locknut Hex	Swivel Nut Hex	Max Drill	Male Turn Back	Tube Nut	Swivel Nut	Pilot Length - Shapes	Length - Straights	Length - Shapes	Locknut Thickness	Pilot Dia (Max)									
2	1/8	—	5/16-24	3/8	9/16	7/16	—	0.062	—	0.45	—	0.19	0.31	0.094	1.11	0.92	0.22	0.313	0.38	0.25	—
3	3/16	—	3/8-24	7/16	5/8	1/2	—	0.125	—	0.48	—	0.25	0.33	0.094	1.11	0.92	0.22	0.375	0.38	0.25	—
4	1/4	6	7/16-20	9/16	11/16	9/16	14	0.172	0.156	0.55	0.56	0.19	0.34	0.094	1.20	1.02	0.28	0.438	0.38	0.25	0.254
5	5/16	8	1/2-20	5/8	3/4	5/8	16	0.234	0.217	0.55	0.56	0.30	0.38	0.094	1.20	1.02	0.28	0.500	0.38	0.25	0.314
6	3/8	10	9/16-18	11/16	13/16	11/16	17	0.297	0.263	0.56	0.57	0.28	0.38	0.094	1.28	1.09	0.27	0.563	0.44	0.35	0.359
8	1/2	12	3/4-16	7/8	1	7/8	22	0.391	0.391	0.66	0.66	0.31	0.42	0.125	1.44	1.25	0.31	0.750	0.44	0.35	0.510
10	5/8	14 15 16	7/8-14	1	1 1/8	1	27	0.484	0.446	0.76	0.81	0.38	0.50	0.125	1.58	1.39	0.36	0.875	0.44	0.35	0.610
12	3/4	18 20	1 1/16-12	1 1/4	1 3/8	1 1/4	32	0.610	0.578	0.86	0.91	0.36	0.56	0.125	1.75	1.56	0.41	1.063	0.44	0.35	0.753
14	7/8	22	1 3/16-12	1 3/8	1 1/2	1 3/8	36	0.718	0.680	0.89	0.95	0.38	0.58	0.125	1.75	1.56	0.41	1.188	0.44	0.35	0.849
16	1	25	1 5/16-12	1 1/2	1 5/8	1 1/2	38	0.844	0.769	0.91	0.99	0.34	0.59	0.125	1.75	1.56	0.41	1.313	0.44	0.35	0.940
20	1 1/4	28 30 32	1 5/8-12	2	1 7/8	2	50	1.078	1.020	0.96	1.03	0.34	0.63	0.125	1.80	1.61	0.41	1.625	0.44	0.35	1.198
24	1 1/2	35 38	1 7/8-12	2 1/4	2 1/8	2 1/4	60	1.312	1.230	1.08	1.16	0.50	0.73	0.125	1.81	1.62	0.41	1.875	0.31	0.22	1.416
32	2	—	2 1/2-12	2 7/8	2 3/4	2 7/8	—	1.781	1.736	1.33	1.40	0.55	0.94	0.125	2.09	1.91	0.41	2.500	0.35	0.25	1.994
40 ²⁾	2 1/2	—	3-12	3 3/8	—	—	—	2.281	—	—	—	0.55	—	0.125	1.72	1.72	0.41	2.998	0.45	0.45	—

1) Recommended clearance hole = W + 0.015.

2) Not a standard SAE J514 size.

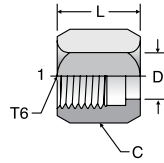
Dimensions and pressures for reference only, subject to change.



BTX

Nut
37° Flare

SAE 070110
HPD Base # 06B



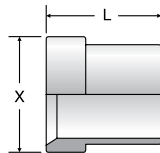
TUBE FITTING PART #	END SIZE		T6 UN/UNF-2B	C HEX (in.)	D (in.)	L (in.)	Material		
	(in.)	(mm)					-S	-SS	-B
2 BTX	1/8	—	5/16 - 24	3/8	0.180	0.55	•	•	•
3 BTX	3/16	—	3/8 - 24	7/16	0.240	0.61	•	•	•
4 BTX	1/4	6	7/16 - 20	9/16	0.310	0.62	•	•	•
5 BTX	5/16	8	1/2 - 20	5/8	0.380	0.68	•	•	•
6 BTX	3/8	10	9/16 - 18	11/16	0.440	0.73	•	•	•
8 BTX	1/2	12	3/4 - 16	7/8	0.570	0.85	•	•	•
10 BTX	5/8	14, 15, 16	7/8 - 14	1	0.700	0.98	•	•	•
12 BTX	3/4	18	1 1/16 - 12	1 1/4	0.840	1.03	•	•	•
20-12 BTX	—	20	1 1/16 - 12	1 1/4	0.862	0.87	•	•	•
14 BTX	7/8	—	1 3/16 - 12	1 3/8	0.960	1.09	•	•	•
16 BTX	1	25	1 5/16 - 12	1 1/2	1.090	1.13	•	•	•
20 BTX	1 1/4	28, 30, 32	1 5/8 - 12	2	1.350	1.23	•	•	•
24 BTX	1 1/2	35, 38	1 7/8 - 12	2 1/4	1.620	1.42	•	•	•
32 BTX	2	42, 50	2 1/2 - 12	2 7/8	2.170	1.75	•	•	•

Note: All stainless steel nuts are coated to prevent galling at assembly.

TX (inch)

Sleeve
37° Flare

SAE 070115
HPD Base # 06S

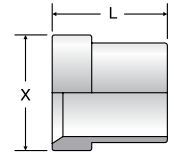


TUBE FITTING PART #	END SIZE (in.)	L (in.)	X (in.)	Material		
				-S	-SS	-B
2 TX	1/8	0.34	0.27	•	•	•
3 TX	3/16	0.34	0.33	•	•	•
4 TX	1/4	0.41	0.38	•	•	•
5 TX	5/16	0.44	0.45	•	•	•
6 TX	3/8	0.50	0.50	•	•	•
8 TX	1/2	0.56	0.68	•	•	•
10 TX	5/8	0.66	0.80	•	•	•
12 TX	3/4	0.69	0.97	•	•	•
14 TX	7/8	0.75	1.10	•	•	•
16 TX	1	0.78	1.22	•	•	•
20 TX	1 1/4	0.91	1.53	•	•	•
24 TX	1 1/2	1.13	1.78	•	•	•
32 TX	2	1.19	2.41	•	•	•

TX (metric)

Sleeve
37° Flare

SAE 070115



TUBE FITTING PART #	See Note	END SIZE (mm)	FITTING DASH SIZE	L (mm)	X (mm)	Material		
						S	SS	B
TXS6	3	6	-4	10.4	9.6	•	•	•
5 TX	1	8	-5	11.2	11.4	•	•	•
TXS10	3	10	-6	12.7	12.7	•	•	•
TXS12	3	12	-8	14.2	17.3	•	•	•
TXS14	3	14	-10	16.8	20.3	•	•	•
TXS15	3	15	-10	16.8	20.3	•	•	•
10 TX	1	16	-10	16.8	20.3	•	•	•
TXS18	3	18	-12	17.3	24.6	•	•	•
20-12 TX	2	20	-12	17.3	24.6	•	•	•
TXS22	3	22	-14	19.0	27.8	•	•	•
TXS25	3	25	-16	19.8	31.0	•	•	•
TXS28	3	28	-20	23.1	38.9	•	•	•
TXS30	3	30	-20	23.1	38.9	•	•	•
TXS32	3	32	-20	23.1	38.9	•	•	•
TXS35	3	35	-24	28.4	45.2	•	•	•
24 TX	1	38	-24	28.4	45.2	•	•	•

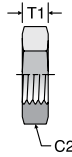
1. Inch sleeve for use with metric tubing.
2. Use with 20-12 BTX.
3. The part numbers above are for steel. Use "SS" in place of "S" for ordering stainless steel. Example: TXSS12

Dimensions and pressures for reference only, subject to change.

WLN

Bulkhead Locknut

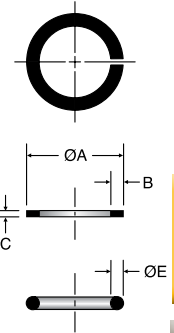
SAE 080118 and 070118
HPD Base # 53-XN



TUBE FITTING PART #	TUBE O.D. (in.)	C2 HEX (in.)	T1 (in.)	Material		
				-S	-SS	-B
3 WLN	3/16	5/8	0.22	•	•	•
4 WLN	1/4	11/16	0.28	•	•	•
5 WLN	5/16	3/4	0.28	•	•	•
6 WLN	3/8	13/16	0.27	•	•	•
8 WLN	1/2	1	0.31	•	•	•
10 WLN	5/8	1 1/8	0.36	•	•	•
12 WLN	3/4	1 3/8	0.41	•	•	•
14 WLN	7/8	1 1/2	0.41	•	•	•
16 WLN	1	1 5/8	0.41	•	•	•
20 WLN	1 1/4	1 7/8	0.41	•	•	•
24 WLN	1 1/2	2 1/8	0.41	•	•	•
32 WLN	2	2 3/4	0.41	•	•	•

SBR

Braze Ring



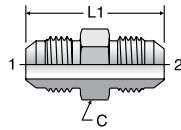
TUBE FITTING PART #	TUBE O.D. (in.)	A DIA. (in.)	B (in.)	C (in.)	E (in.)	Material		
						-S	-SS	-B
4 SBR	1/4	0.260	—	—	0.05	•	•	•
6 SBR	3/8	0.390	0.07	0.03	—	•	•	•
8 SBR	1/2	0.515	0.07	0.03	—	•	•	•
10 SBR	5/8	0.640	0.07	0.03	—	•	•	•
12 SBR	3/4	0.765	0.08	0.04	—	•	•	•
14 SBR	7/8	0.890	—	—	0.06	•	•	•
16 SBR	1	1.015	0.08	0.04	—	•	•	•
20 SBR	1 1/4	1.265	0.08	0.04	—	•	•	•
24 SBR	1 1/2	1.515	0.08	0.04	—	•	•	•
32 SBR	2	2.015	—	—	0.09	•	•	•

TABLE OF CONTENTS
VISUAL INDEX

HTX

Union
37° Flare / 37° Flare

SAE 070101
HPD Base # 0303

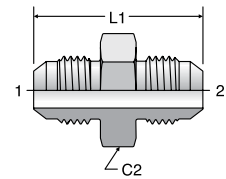


TUBE FITTING PART #	END SIZE		C HEX (in.)	L1 (in.)	Dynamic Pressure (x 1,000 PSI)		
	1 (in.)	2 (in.)			-S	-SS	-B
	2 HTX	1/8					
3 HTX	3/16	3/16	7/16	1.23	7.5	9.0	3.3
4 HTX	1/4	1/4	1/2	1.37	7.5	9.0	3.3
4-2 HTX	1/4	1/8	1/2	1.27	7.5	9.0	3.3
4-3 HTX	1/4	3/16	1/2	1.30	7.5	9.0	3.3
5 HTX	5/16	5/16	9/16	1.37	6.0	7.2	3.3
5-4 HTX	5/16	1/4	9/16	1.38	6.0	7.2	3.3
6 HTX	3/8	3/8	5/8	1.41	6.0	7.2	3.3
6-4 HTX	3/8	1/4	5/8	1.41	6.0	7.2	3.3
6-5 HTX	3/8	5/16	5/8	1.41	6.0	7.2	3.3
8 HTX	1/2	1/2	13/16	1.62	6.0	7.2	3.3
8-4 HTX	1/2	1/4	13/16	1.52	6.0	7.2	3.3
8-6 HTX	1/2	3/8	13/16	1.52	6.0	7.2	3.3
10 HTX	5/8	5/8	15/16	1.88	5.0	6.0	3.3
10-8 HTX	5/8	1/2	15/16	1.78	5.0	6.0	3.3
12 HTX	3/4	3/4	1 1/8	2.16	5.0	6.0	3.3
12-8 HTX	3/4	1/2	1 1/8	1.95	5.0	6.0	3.3
12-10 HTX	3/4	5/8	1 1/8	2.05	5.0	6.0	3.3
14 HTX	7/8	7/8	1 1/4	2.22	5.0	6.0	2.6
16 HTX	1	1	1 3/8	2.25	4.0	4.8	2.6
16-12 HTX	1	3/4	1 3/8	2.20	4.0	4.8	2.6
20 HTX	1 1/4	1 1/4	1 11/16	2.43	4.0	4.8	2.6
24 HTX	1 1/2	1 1/2	2	2.75	3.0	3.6	2.0
24-10 HTX	1 1/2	5/8	2	2.42	3.0	3.6	2.0
24-12 HTX	1 1/2	3/4	2	2.53	3.0	3.6	2.0
24-16 HTX	1 1/2	1	2	2.58	3.0	3.6	2.0
32 HTX	2	2	2 5/8	3.40	2.0	2.4	1.3
32-24 HTX	2	1 1/2	2 5/8	2.81	2.0	2.4	1.3

LHTX

Large Hex Union
37° Flare / 37° Flare

SAE 070119
HPD Base # 03L3



TUBE FITTING PART #	END SIZE		C2 HEX (in.)	L1 (in.)	Dynamic Pressure (x 1,000 PSI)		
	1 (in.)	2 (in.)			-S	-SS	-B
	4 LHTX	1/4					
4-3 LHTX	1/4	3/16	11/16	1.30	7.5	9.0	3.3
5 LHTX	5/16	5/16	3/4	1.37	6.0	7.2	3.3
6 LHTX	3/8	3/8	13/16	1.41	6.0	7.2	3.3
6-4 LHTX	3/8	1/4	13/16	1.41	6.0	7.2	3.3
8 LHTX	1/2	1/2	1	1.62	6.0	7.2	3.3
8-4 LHTX	1/2	1/4	1	1.52	6.0	7.2	3.3
8-6 LHTX	1/2	3/8	1	1.52	6.0	7.2	3.3
10 LHTX	5/8	5/8	1 1/8	1.88	5.0	6.0	3.3
12 LHTX	3/4	3/4	1 3/8	2.16	5.0	6.0	3.3
12-8 LHTX	3/4	1/2	1 3/8	1.95	5.0	6.0	3.3
16 LHTX	1	1	1 5/8	2.25	4.0	4.8	2.6
32 LHTX	2	2	2 3/4	3.40	2.0	2.4	1.3

• Contact TFD

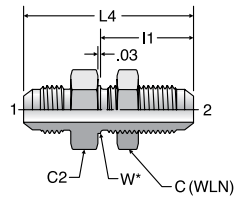
Dimensions and pressures for reference only, subject to change.



WTX

Bulkhead Union
37° Flare / 37° Flare

SAE 070601
HPD Base # 0353
WTX-WLN – Body with locknut
(See page B10 for WLN)

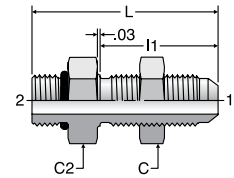


W* – Bulkhead pilot dia.
recommended clearance hole
+.015 over W dia.

WF5OX

SAE-ORB Bulkhead Connector
37° Flare / SAE-ORB

HPD Base # 0355
WF5OX-WLN – Body with locknut
(See page B10 for WLN)



B

TABLE
OF
CONTENTS

TUBE FITTING PART #	END SIZE		C HEX (in.)	C2 HEX (in.)	I1 (in.)	L4 (in.)	W DIA (in.)	MAX BULKHEAD WALL THICKNESS (in.)	Dynamic Pressure (x 1,000 PSI)		
	1 & 2 (in.)	2 (in.)							-S	-SS	-B
3 WTX	3/16	5/8	5/8	1.11	1.90	0.38	0.38	7.5	9.0	3.3	
4 WTX	1/4	11/16	11/16	1.20	2.07	0.44	0.38	7.5	9.0	3.3	
5 WTX	5/16	3/4	3/4	1.20	2.07	0.50	0.38	6.0	7.2	3.3	
6 WTX	3/8	13/16	13/16	1.28	2.18	0.56	0.44	6.0	7.2	3.3	
8 WTX	1/2	1	1	1.44	2.44	0.75	0.44	6.0	7.2	3.3	
10 WTX	5/8	1 1/8	1 1/8	1.58	2.74	0.88	0.44	5.0	6.0	3.3	
12 WTX	3/4	1 3/8	1 3/8	1.75	3.09	1.06	0.44	5.0	6.0	3.3	
14 WTX	7/8	1 1/2	1 1/2	1.75	3.12	1.19	0.44	5.0	6.0	3.3	
16 WTX	1	1 5/8	1 5/8	1.75	3.14	1.31	0.44	4.0	4.8	2.6	
20 WTX	1 1/4	1 7/8	1 7/8	1.80	3.31	1.63	0.44	4.0	4.8	2.6	
24 WTX	1 1/2	2 1/8	2 1/8	1.81	3.52	1.88	0.31	3.0	3.6	2.0	
32 WTX	2	2 3/4	2 3/4	2.09	4.20	2.50	0.35	2.0	2.4	1.3	

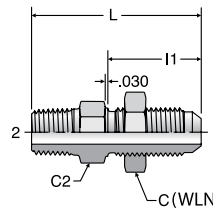
TUBE FITTING PART #	END SIZE		C HEX (in.)	C2 HEX (in.)	I1 (in.)	L (in.)	MAX BULKHEAD WALL THICKNESS (in.)	Dynamic Pressure (x 1,000 PSI)		
	1 (in.)	2 UN/UNF-2A						-S	-SS	-B
4 WF5OX	1/4	7/16 - 20	11/16	11/16	1.20	1.84	0.38	7.5	9.0	3.3
6 WF5OX	3/8	9/16 - 18	13/16	13/16	1.28	2.02	0.44	6.0	7.2	3.3
8 WF5OX	1/2	3/4 - 16	1	1	1.44	2.19	0.44	6.0	7.2	3.3
10 WF5OX	5/8	7/8 - 14	1 1/8	1 1/8	1.58	2.47	0.44	5.0	6.0	3.3
12 WF5OX	3/4	1 1/16 - 12	1 3/8	1 3/8	1.75	2.79	0.44	5.0	6.0	3.3
16 WF5OX	1	1 5/16 - 12	1 5/8	1 5/8	1.75	2.90	0.44	4.5	5.4	2.9

VISUAL
INDEX

WFTX

Male Bulkhead Connector
37° Flare / NPTF

HPD Base # 0153
WFTX-WLN – Body with locknut
(See page B10 for WLN)



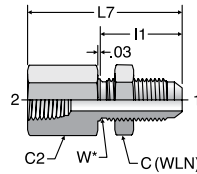
TUBE FITTING PART #	END SIZE		C HEX (in.)	C2 HEX (in.)	I1 (in.)	L (in.)	MAX BULKHEAD WALL THICKNESS (in.)	Dynamic Pressure (x 1,000 PSI)		
	1 (in.)	2 NPTF						-S	-SS	-B
4 WFTX	1/4	1/8 - 27	11/16	11/16	1.20	1.88	0.38	6.0	6.0	3.3
4-4 WFTX	1/4	1/4 - 18	11/16	11/16	1.20	2.10	0.38	6.0	6.0	3.3
6 WFTX	3/8	1/4 - 18	13/16	13/16	1.28	2.18	0.44	6.0	6.0	3.3
6-6 WFTX	3/8	3/8 - 18	13/16	13/16	1.28	2.16	0.44	6.0	6.0	3.3
6-8 WFTX	3/8	1/2 - 14	7/8	13/16	1.28	2.41	0.44	6.0	6.0	3.3
8 WFTX	1/2	3/8 - 18	1	1	1.44	2.34	0.44	6.0	6.0	3.3
8-8 WFTX	1/2	1/2 - 14	1	1	1.44	2.60	0.44	6.0	6.0	3.3
10 WFTX	5/8	1/2 - 14	1 1/8	1 1/8	1.58	2.74	0.44	5.0	5.0	3.3
12 WFTX	3/4	3/4 - 14	1 3/8	1 3/8	1.75	2.95	0.44	5.0	5.0	2.6
16 WFTX	1	1 - 11 1/2	1 5/8	1 5/8	1.75	3.14	0.44	4.5	4.5	2.0

Dimensions and pressures for reference only, subject to change.

WGTX

Female Bulkhead Connector
37° Flare / NPTF

HPD Base # 0253
WGTX-WLN – Body with locknut
(See page B10 for WLN)



W* – Bulkhead pilot dia.
recommended clearance hole
+.015 over W dia.

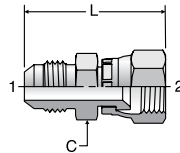
TABLE
OF
CONTENTS

VISUAL
INDEX

TUBE FITTING PART #	END SIZE		C HEX (in.)	C2 HEX (in.)	I1 (in.)	L7 (in.)	W DIA (in.)	MAX BULKHEAD WALL THICKNESS (in.)	Dynamic Pressure (x 1,000 PSI)		
	1 (in.)	2 NPTF							-S	-SS	-B
	4 WGTX	1/4							1/8 - 27	11/16	11/16
4-4 WGTX	1/4	1/4 - 18	11/16	3/4	1.20	2.11	0.44	0.38	6.0	6.0	3.3
6 WGTX	3/8	1/4 - 18	13/16	13/16	1.28	2.12	0.56	0.44	6.0	6.0	3.3
6-6 WGTX	3/8	3/8 - 18	13/16	7/8	1.28	2.24	0.56	0.44	6.0	6.0	3.3
8 WGTX	1/2	3/8 - 18	1	1	1.44	2.34	0.75	0.44	6.0	6.0	3.3
8-8 WGTX	1/2	1/2 - 14	1	1 1/8	1.44	2.61	0.75	0.44	5.0	5.0	3.3
10 WGTX	5/8	1/2 - 14	1 1/8	1 1/8	1.58	2.71	0.88	0.44	5.0	5.0	3.3
12 WGTX	3/4	3/4 - 14	1 3/8	1 3/8	1.75	2.95	1.06	0.44	4.0	4.0	2.6
14 WGTX	7/8	3/4 - 14	1 3/8	1 1/2	1.75	2.92	1.19	0.41	4.0	4.0	2.6
16 WGTX	1	1 - 11 1/2	1 5/8	1 5/8	1.75	3.19	1.31	0.44	3.0	3.0	2.0
24 WGTX	1 1/2	1 1/2-11 1/2	2 1/8	2 1/4	1.81	3.35	1.88	0.31	2.0	2.0	1.3

XHX6

Extender and Expander
37° Flare / 37° Flare Swivel



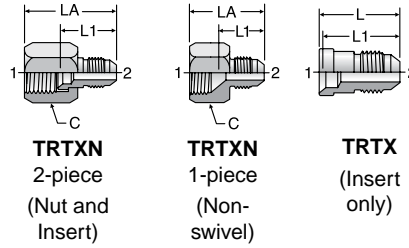
TUBE FITTING PART #	END SIZE		C HEX (in.)	L (in.)	Dynamic Pressure (x 1,000 PSI)		
	1 (in.)	2 (in.)			-S	-SS	-B
	4 XHX6	1/4			1/4	9/16	1.39
6 XHX6	3/8	3/8	5/8	1.50	6.0	6.0	3.3
6-4 XHX6	3/8	1/4	5/8	1.50	6.0	6.0	3.3
8 XHX6	1/2	1/2	13/16	1.71	6.0	6.0	3.3
8-6 XHX6	1/2	3/8	13/16	1.72	6.0	6.0	3.3
10 XHX6	5/8	5/8	1	2.01	5.0	5.0	3.3
10-8 XHX6	5/8	1/2	15/16	1.93	5.0	5.0	3.3
12 XHX6	3/4	3/4	1 1/4	2.20	5.0	5.0	3.3
12-10 XHX6	3/4	5/8	1 1/8	2.19	5.0	5.0	3.3
16 XHX6	1	1	1 1/2	2.47	4.0	3.0	2.6
16-12 XHX6	1	3/4	1 1/2	2.24	4.0	3.0	2.6
20-16 XHX6	1 1/4	1	1 11/16	2.50	4.0	3.0	2.6

Dimensions and pressures for reference only, subject to change.

TRTX / TRTXN

Reducer
37° Flare

SAE 070123 / SAE 070123A
HPD Base # 0603 (TRTXN only)



B

TABLE
OF
CONTENTS

VISUAL
INDEX

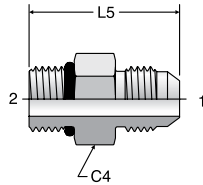
TUBE FITTING PART #			END SIZE		C HEX (in.)	L (TRTX) (in.)	LA (TRTXN) (in.)	L1 (TRTX & TRTXN) (in.)	Dynamic Pressure (x 1,000 PSI)		
TRTXN 2-pc. Design (with Large Nut)	TRTXN 1-pc. Design (Machined Female)	TRTX Reducer Insert (For 2-pc. Design Only)	1 (in.)	2 (in.)					-S	-SS	-B
4-2 TRTXN	-	4-2 TRTX	1/4	1/8	9/16	0.75	1.14	0.68	7.5	9.0	3.3
-	4-3 TRTXN	-	1/4	3/16	9/16	-	1.09	0.64	7.5	9.0	3.3
-	5-4 TRTXN	-	5/16	1/4	5/8	-	1.16	0.69	6.0	7.2	3.3
6-4 TRTXN	-	6-4 TRTX	3/8	1/4	11/16	0.97	1.40	0.90	6.0	7.2	3.3
-	6-5 TRTXN	-	3/8	5/16	11/16	-	1.19	0.73	6.0	7.2	3.3
8-4 TRTXN	-	8-4 TRTX	1/2	1/4	7/8	1.00	1.50	0.90	6.0	7.2	3.3
8-6 TRTXN	-	8-6 TRTX	1/2	3/8	7/8	1.00	1.50	0.90	6.0	7.2	3.3
10-4 TRTXN	-	10-4 TRTX	5/8	1/4	1	1.03	1.61	0.93	5.0	6.0	3.3
10-6 TRTXN	-	10-6 TRTX	5/8	3/8	1	1.03	1.61	0.93	5.0	6.0	3.3
-	10-8 TRTXN	-	5/8	1/2	1	-	1.48	0.85	5.0	6.0	3.3
12-4 TRTXN	-	12-4 TRTX	3/4	1/4	1 1/4	1.09	1.69	0.95	5.0	6.0	3.3
12-6 TRTXN	-	12-6 TRTX	3/4	3/8	1 1/4	1.09	1.69	0.95	5.0	6.0	3.3
12-8 TRTXN	-	12-8 TRTX	3/4	1/2	1 1/4	1.19	1.79	1.05	5.0	6.0	3.3
-	12-10 TRTXN	-	3/4	5/8	1 1/4	-	1.66	0.96	5.0	6.0	3.3
14-6 TRTXN	-	14-6 TRTX	7/8	3/8	1 3/8	1.13	1.78	1.00	5.0	6.0	3.3
14-10 TRTXN	-	14-10 TRTX	7/8	5/8	1 3/8	1.33	1.98	1.20	5.0	6.0	3.3
-	14-12 TRTXN	-	7/8	3/4	1 3/8	-	1.84	1.11	5.0	6.0	3.3
16-4 TRTXN	-	16-4 TRTX	1	1/4	1 1/2	1.22	1.90	1.09	4.5	5.4	2.9
16-6 TRTXN	-	16-6 TRTX	1	3/8	1 1/2	1.22	1.90	1.09	4.5	5.4	2.9
16-8 TRTXN	-	16-8 TRTX	1	1/2	1 1/2	1.27	1.95	1.14	4.5	5.4	2.9
16-10 TRTXN	-	16-10 TRTX	1	5/8	1 1/2	1.38	2.06	1.25	4.5	5.4	2.9
16-12 TRTXN	-	16-12 TRTX	1	3/4	1 1/2	1.47	2.15	1.34	4.5	5.4	2.9
-	16-14 TRTXN	-	1	7/8	1 1/2	-	1.91	1.15	4.5	5.4	2.9
-	-	20-8 TRTX	1 1/4	1/2	-	1.41	-	1.25	4.0	4.8	2.6
20-12 TRTXN	-	20-12 TRTX	1 1/4	3/4	2	1.53	2.17	1.37	4.0	4.8	2.6
20-16 TRTXN	-	20-16 TRTX	1 1/4	1	2	1.59	2.23	1.43	4.0	4.8	2.6
-	-	24-4 TRTX	1 1/2	1/4	-	1.47	-	1.32	3.0	3.6	2.0
24-8 TRTXN	-	24-8 TRTX	1 1/2	1/2	2 1/4	1.56	2.33	1.41	3.0	3.6	2.0
24-12 TRTXN	-	24-12 TRTX	1 1/2	3/4	2 1/4	1.63	2.40	1.48	3.0	3.6	2.0
24-16 TRTXN	-	24-16 TRTX	1 1/2	1	2 1/4	1.59	2.40	1.48	3.0	3.6	2.0
24-20 TRTXN	-	24-20 TRTX	1 1/2	1 1/4	2 1/4	1.69	2.46	1.54	3.0	3.6	2.0
-	-	32-12 TRTX	2	3/4	-	1.78	-	1.81	2.0	2.4	1.3
-	-	32-20 TRTX	2	1 1/4	-	1.78	-	1.59	2.0	2.4	1.3
32-24 TRTXN	-	32-24 TRTX	2	1 1/2	2 7/8	1.91	2.97	1.71	2.0	2.4	1.3

Dimensions and pressures for reference only, subject to change.

F50X

Straight Thread Connector
37° Flare / SAE-ORB

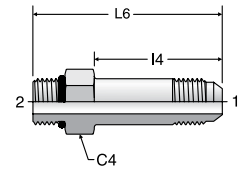
SAE 070120
HPD Base # 0503



FF50X

Long Straight Thread Connector
37° Flare / SAE-ORB

SAE 071720
HPD Base # 053E

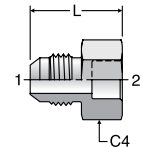


TUBE FITTING PART #	END SIZE		C4 HEX (in.)	L5 (in.)	Dynamic Pressure (x 1,000 PSI)		
	1 (in.)	2 UN/UNF-2A			-S	-SS	-B
2 F50X	1/8	5/16 - 24	7/16	1.06	7.5	9.0	3.3
3 F50X	3/16	3/8 - 24	1/2	1.10	7.5	9.0	3.3
3-2 F50X	3/16	5/16 - 24	1/2	1.10	7.5	9.0	3.3
4 F50X	1/4	7/16 - 20	9/16	1.23	7.5	9.0	3.3
4-2 F50X	1/4	5/16 - 24	9/16	1.17	7.5	9.0	3.3
4-3 F50X	1/4	3/8 - 24	9/16	1.19	7.5	9.0	3.3
4-5 F50X	1/4	1/2 - 20	5/8	1.23	6.0	7.2	3.3
4-6 F50X	1/4	9/16 - 18	11/16	1.29	6.0	7.2	3.3
4-8 F50X	1/4	3/4 - 16	7/8	1.38	6.0	7.2	3.3
4-10 F50X	1/4	7/8 - 14	1	1.49	5.0	6.0	3.3
5 F50X	5/16	1/2 - 20	5/8	1.23	6.0	7.2	3.3
5-4 F50X	5/16	7/16 - 20	9/16	1.23	6.0	7.2	3.3
5-6 F50X	5/16	9/16 - 18	11/16	1.30	6.0	7.2	3.3
5-8 F50X	5/16	3/4 - 16	7/8	1.37	6.0	7.2	3.3
6 F50X	3/8	9/16 - 18	11/16	1.30	6.0	7.2	3.3
6-4 F50X	3/8	7/16 - 20	5/8	1.27	6.0	7.2	3.3
6-5 F50X	3/8	1/2 - 20	5/8	1.27	6.0	7.2	3.3
6-8 F50X	3/8	3/4 - 16	7/8	1.38	6.0	7.2	3.3
6-10 F50X	3/8	7/8 - 14	1	1.50	5.0	6.0	3.3
6-12 F50X	3/8	1 1/16 - 12	1 1/4	1.66	5.0	6.0	3.3
8 F50X	1/2	3/4 - 16	7/8	1.48	6.0	7.2	3.3
8-4 F50X	1/2	7/16 - 20	13/16	1.50	6.0	7.2	3.3
8-6 F50X	1/2	9/16 - 18	13/16	1.44	6.0	7.2	3.3
8-10 F50X	1/2	7/8 - 14	1.00	1.60	5.0	6.0	3.3
8-12 F50X	1/2	1 1/16 - 12	1 1/4	1.76	5.0	6.0	3.3
8-16 F50X	1/2	1 5/16 - 12	1 1/2	1.78	4.5	5.4	2.9
10 F50X	5/8	7/8 - 14	1	1.70	5.0	6.0	3.3
10-6 F50X	5/8	9/16 - 18	15/16	1.71	5.0	6.0	3.3
10-8 F50X	5/8	3/4 - 16	15/16	1.64	5.0	6.0	3.3
10-12 F50X	5/8	1 1/16 - 12	1 1/4	1.86	5.0	6.0	3.3
10-16 F50X	5/8	1 5/16 - 12	1 1/2	1.89	4.5	5.4	2.9
12 F50X	3/4	1 1/16 - 12	1 1/4	1.97	5.0	6.0	3.3
12-8 F50X	3/4	3/4 - 16	1 1/8	1.94	5.0	6.0	3.3
12-10 F50X	3/4	7/8 - 14	1 1/8	1.88	5.0	6.0	3.3
12-14 F50X	3/4	1 3/16 - 12	1 3/8	1.96	5.0	6.0	3.3
12-16 F50X	3/4	1 5/16 - 12	1 1/2	1.99	4.5	5.4	2.9
12-20 F50X	3/4	1 5/8 - 12	1 7/8	2.08	4.0	4.8	2.6
14 F50X	7/8	1 3/16 - 12	1 3/8	1.99	5.0	6.0	3.3
14-16 F50X	7/8	1 5/16 - 12	1 1/2	2.02	4.5	5.4	2.9
16 F50X	1	1 5/16 - 12	1 1/2	2.04	4.5	5.4	2.9
16-8 F50X	1	3/4 - 16	1 3/8	1.78	4.5	5.4	2.9
16-10 F50X	1	7/8 - 14	1 3/8	2.08	4.5	5.4	2.9
16-12 F50X	1	1 1/16 - 12	1 3/8	1.99	4.5	5.4	2.9
16-14 F50X	1	1 3/16 - 12	1 3/8	2.05	4.5	5.4	2.9
16-20 F50X	1	1 5/8 - 12	1 7/8	2.12	4.0	4.8	2.6
16-24 F50X	1	1 7/8 - 12	2 1/8	2.20	3.0	3.6	2.0
20 F50X	1 1/4	1 5/8 - 12	1 7/8	2.17	4.0	4.8	2.6
20-12 F50X	1 1/4	1 1/16 - 12	1 11/16	2.30	4.0	4.8	2.6
20-16 F50X	1 1/4	1 5/16 - 12	1 11/16	2.33	4.0	4.8	2.6
20-24 F50X	1 1/4	1 7/8 - 12	2 1/8	2.24	3.0	3.6	2.0
24 F50X	1 1/2	1 7/8 - 12	2 1/8	2.38	3.0	3.6	2.0
24-20 F50X	1 1/2	1 5/8 - 12	2	2.53	3.0	3.6	2.0
24-32 F50X	1 1/2	2 1/2 - 12	2 3/4	2.53	2.0	2.4	1.3
32 F50X	2	2 1/2 - 12	2 3/4	2.78	2.0	2.4	1.3
32-24 F50X	2	1 7/8 - 12	2 5/8	2.94	2.0	2.4	1.3

TUBE FITTING PART #	END SIZE		C4 HEX (in.)	I4 (in.)	L6 (in.)	Dynamic Pressure (x 1,000 PSI)		
	1 (in.)	2 UN/UNF-2A				-S	-SS	-B
4 FF50X	1/4	7/16 - 20	9/16	1.39	2.08	7.5	9.0	3.3
4-6 FF50X	1/4	9/16 - 18	11/16	1.38	2.13	6.0	7.2	3.3
6 FF50X	3/8	9/16 - 18	11/16	1.56	2.31	6.0	7.2	3.3
8 FF50X	1/2	3/4 - 16	7/8	1.88	2.70	6.0	7.2	3.3
10 FF50X	5/8	7/8 - 14	1	2.09	3.04	5.0	6.0	3.3
12 FF50X	3/4	1 1/16 - 12	1 1/4	2.50	3.61	5.0	6.0	3.3
16 FF50X	1	1 5/16 - 12	1 1/2	2.84	3.98	4.5	5.4	2.9
20 FF50X	1 1/4	1 5/8 - 12	1 7/8	3.47	4.69	4.0	4.8	2.6

XHB3

Braze Socket
37° Flare / Inch Tube Braze



TUBE FITTING PART #	END SIZE		C4 HEX (in.)	L (in.)	Dynamic Pressure (x 1,000 PSI)		
	1 (in.)	2 (in.)			-S	-SS	-B
4 XHB3	1/4	1/4	9/16	0.97	7.5	7.5	3.3
6 XHB3	3/8	3/8	5/8	1.00	6.0	6.0	3.3
6-4 XHB3	3/8	1/4	5/8	1.00	6.0	6.0	3.3
6-8 XHB3	3/8	1/2	5/8	1.00	6.0	6.0	3.3
8 XHB3	1/2	1/2	13/16	1.12	6.0	6.0	3.3
8-10 XHB3	1/2	5/8	13/16	1.12	5.0	5.0	3.3
10 XHB3	5/8	5/8	15/16	1.21	5.0	5.0	3.3
10-8 XHB3	5/8	1/2	15/16	1.21	5.0	5.0	3.3
10-12 XHB3	5/8	3/4	1 1/8	1.37	5.0	5.0	3.3
12 XHB3	3/4	3/4	1 1/4	1.51	5.0	5.0	3.3
12-10 XHB3	3/4	5/8	1 1/8	1.51	5.0	5.0	3.3
12-16 XHB3	3/4	1	1 1/4	1.57	4.0	4.0	2.6
16 XHB3	1	1	1 3/8	1.63	4.0	4.0	2.6
16-20 XHB3	1	1 1/4	1 11/16	1.73	4.0	4.0	2.6
20 XHB3	1 1/4	1 1/4	1 11/16	1.71	4.0	4.0	2.6
20-24 XHB3	1 1/4	1 1/2	2	1.71	3.0	3.0	2.0
24 XHB3	1 1/2	1 1/2	2	1.84	3.0	3.0	2.0
32 XHB3	2	2	2 5/8	2.16	2.0	2.0	1.3

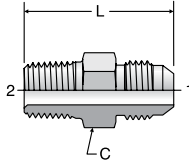
Note: Braze rings are on page B10.

Dimensions and pressures for reference only, subject to change.

FTX

Male Connector
37° Flare / NPTF

SAE 070102
HPD Base # 0103

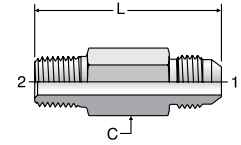


TUBE FITTING PART #	END SIZE		C HEX (in.)	L (in.)	Dynamic Pressure (x 1,000 PSI)		
	1 (in.)	2 NPTF			-S	-SS	-B
3 FTX	3/16	1/8 - 27	7/16	1.14	6.0	6.0	3.3
4 FTX	1/4	1/8 - 27	1/2	1.22	6.0	6.0	3.3
4-4 FTX	1/4	1/4 - 18	9/16	1.42	6.0	6.0	3.3
4-6 FTX	1/4	3/8 - 18	3/4	1.44	6.0	6.0	3.3
4-8 FTX	1/4	1/2 - 14	7/8	1.69	6.0	6.0	3.3
5 FTX	5/16	1/8 - 27	9/16	1.22	6.0	6.0	3.3
5-4 FTX	5/16	1/4 - 18	9/16	1.42	6.0	6.0	3.3
5-6 FTX	5/16	3/8 - 18	3/4	1.44	6.0	6.0	3.3
6 FTX	3/8	1/4 - 18	5/8	1.43	6.0	6.0	3.3
6-2 FTX	3/8	1/8 - 27	5/8	1.24	6.0	6.0	3.3
6-6 FTX	3/8	3/8 - 18	3/4	1.43	6.0	6.0	3.3
6-8 FTX	3/8	1/2 - 14	7/8	1.69	6.0	6.0	3.3
6-12 FTX	3/8	3/4 - 14	1 1/8	1.75	5.5	5.5	3.3
8 FTX	1/2	3/8 - 18	13/16	1.53	6.0	6.0	3.3
8-2 FTX	1/2	1/8 - 27	13/16	1.34	6.0	6.0	3.3
8-4 FTX	1/2	1/4 - 18	13/16	1.53	6.0	6.0	3.3
8-8 FTX	1/2	1/2 - 14	7/8	1.79	6.0	6.0	3.3
8-12 FTX	1/2	3/4 - 14	1 1/8	1.85	5.5	5.5	2.6
8-16 FTX	1/2	1 - 11 1/2	1 3/8	2.05	4.5	4.5	2.0
10 FTX	5/8	1/2 - 14	15/16	1.89	5.0	5.0	3.3
10-6 FTX	5/8	3/8 - 18	15/16	1.70	5.0	5.0	3.3
10-12 FTX	5/8	3/4 - 14	1 1/8	1.95	5.0	5.0	2.6
12 FTX	3/4	3/4 - 14	1 1/8	2.06	5.0	5.0	2.6
12-6 FTX	3/4	3/8 - 18	1 1/8	1.87	5.0	5.0	3.3
12-8 FTX	3/4	1/2 - 14	1 1/8	2.06	5.0	5.0	3.3
12-16 FTX	3/4	1 - 11 1/2	1 3/8	2.25	5.0	5.0	2.0
12-20 FTX	3/4	1 1/4 - 11 1/2	1 11/16	2.36	3.0	3.0	1.6
14 FTX	7/8	3/4 - 14	1 1/4	2.09	5.0	5.0	2.9
16 FTX	1	1 - 11 1/2	1 3/8	2.30	4.5	4.5	2.0
16-8 FTX	1	1/2 - 14	1 3/8	2.11	4.5	4.5	2.9
16-12 FTX	1	3/4 - 14	1 3/8	2.11	4.5	4.5	2.6
16-20 FTX	1	1 1/4 - 11 1/2	1 11/16	2.40	3.0	3.0	1.6
16-24 FTX	1	1 1/2 - 11 1/2	2	2.50	3.0	3.0	1.3
20 FTX	1 1/4	1 1/4 - 11 1/2	1 11/16	2.45	3.0	3.0	1.6
20-16 FTX	1 1/4	1 - 11 1/2	1 11/16	2.42	3.0	3.0	2.0
20-24 FTX	1 1/4	1 1/2 - 11 1/2	2	2.55	3.0	3.0	1.3
24 FTX	1 1/2	1 1/2 - 11 1/2	2	2.68	3.0	3.0	1.3
24-16 FTX	1 1/2	1 - 11 1/2	2	2.62	3.0	3.0	2.0
24-20 FTX	1 1/2	1 1/4 - 11 1/2	2	2.66	3.0	3.0	1.6
24-32 FTX	1 1/2	2 - 11 1/2	2 5/8	2.86	2.0	2.0	1.0
32 FTX	2	2 - 11 1/2	2 5/8	3.11	2.0	2.0	1.0
32-24 FTX	2	1 1/2 - 11 1/2	2 5/8	3.08	2.0	2.0	1.3
40 FTX	2 1/2	2 1/2 - 8	3 1/4	3.38	1.0	1.0	0.5

FFTX

Long Male Connector
37° Flare / NPTF

SAE 071802
HPD Base # 013E

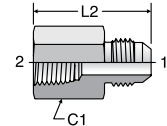


TUBE FITTING PART #	END SIZE		C (in.)	L (in.)	Dynamic Pressure (x 1,000 PSI)		
	1 (in.)	2 NPTF			-S	-SS	-B
4-4 FFTX	1/4	1/4 - 18	9/16	2.25	6.0	6.0	3.3
6 FFTX	3/8	1/4 - 18	5/8	2.25	6.0	6.0	3.3
6-6 FFTX	3/8	3/8 - 18	3/4	2.50	6.0	6.0	3.3
8 FFTX	1/2	3/8 - 18	13/16	2.75	6.0	6.0	3.3
8-8 FFTX	1/2	1/2 - 14	15/16	2.80	6.0	6.0	3.3
10 FFTX	5/8	1/2 - 14	15/16	3.12	5.0	5.0	3.3
12 FFTX	3/4	3/4 - 14	1 1/8	3.50	5.0	5.0	2.6

GTX

Female Connector
37° Flare / NPTF

SAE 070103
HPD Base # 0203



TUBE FITTING PART #	END SIZE		C1 HEX (in.)	L2 (in.)	Dynamic Pressure (x 1,000 PSI)		
	1 (in.)	2 NPTF			-S	-SS	-B
3 GTX	3/16	1/8 - 27	9/16	1.13	6.0	6.0	3.3
4 GTX	1/4	1/8 - 27	9/16	1.19	6.0	6.0	3.3
4-4 GTX	1/4	1/4 - 18	3/4	1.39	6.0	6.0	3.3
4-6 GTX	1/4	3/8 - 18	7/8	1.45	6.0	6.0	3.3
4-8 GTX	1/4	1/2 - 14	1 1/8	1.68	6.0	6.0	3.3
5 GTX	5/16	1/8 - 27	9/16	1.17	6.0	6.0	3.3
5-4 GTX	5/16	1/4 - 18	3/4	1.39	6.0	6.0	3.3
6 GTX	3/8	1/4 - 18	3/4	1.40	6.0	6.0	3.3
6-2 GTX	3/8	1/8 - 27	5/8	1.19	6.0	6.0	3.3
6-6 GTX	3/8	3/8 - 18	7/8	1.46	6.0	6.0	3.3
6-8 GTX	3/8	1/2 - 14	1 1/8	1.69	5.0	5.0	3.3
8 GTX	1/2	3/8 - 18	7/8	1.56	6.0	6.0	3.3
8-4 GTX	1/2	1/4 - 18	13/16	1.55	6.0	6.0	3.3
8-8 GTX	1/2	1/2 - 14	1 1/8	1.79	5.0	5.0	3.3
8-12 GTX	1/2	3/4 - 14	1 3/8	1.85	4.0	4.0	2.6
10 GTX	5/8	1/2 - 14	1 1/8	1.89	5.0	5.0	3.3
10-12 GTX	5/8	3/4 - 14	1 3/8	1.95	4.0	4.0	2.6
12 GTX	3/4	3/4 - 14	1 3/8	2.06	4.0	4.0	2.6
12-8 GTX	3/4	1/2 - 14	1 1/8	2.05	5.0	5.0	2.6
12-16 GTX	3/4	1 - 11 1/2	1 5/8	2.30	3.0	3.0	2.0
14 GTX	7/8	3/4 - 14	1 3/8	2.06	4.0	4.0	2.6
16 GTX	1	1 - 11 1/2	1 5/8	2.35	3.0	3.0	2.0
16-12 GTX	1	3/4 - 14	1 3/8	2.13	4.0	4.0	2.6
16-20 GTX	1	1 1/4 - 11 1/2	2	2.44	2.5	2.5	1.6
20 GTX	1 1/4	1 1/4 - 11 1/2	2	2.49	2.5	2.5	1.6
20-16 GTX	1 1/4	1 - 11 1/2	1 3/4	2.47	3.0	3.0	2.0
24 GTX	1 1/2	1 1/2 - 11 1/2	2 3/8	2.62	2.0	2.0	1.3
32 GTX	2	2 - 11 1/2	2 7/8	2.97	1.5	1.5	1.0

Dimensions and pressures for reference only, subject to change.



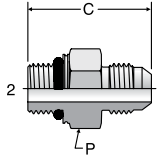
TABLE OF CONTENTS

VISUAL INDEX

B

F87OMX

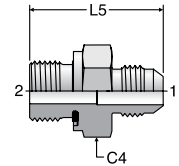
Male Connector – ISO 6149
37° Flare / ISO 6149



TUBE FITTING PART #	END SIZE			C (mm)	P (mm)	Dynamic Pressure (x 1,000 PSI)		
	1		Male Metric Parallel Thread			S	SS	B
	(mm)	(in.)						
4M10F87OMX	6	1/4	M10x1	30.0	14	7.2	5.0	3.3
5M12F87OMX	8	5/16	M12x1.5	33.1	19	6.0	5.0	3.3
6M14F87OMX	10	3/8	M14x1.5	34.1	19	6.0	5.0	3.3
6M16F87OMX	10	3/8	M16x1.5	35.5	22	6.0	5.0	3.3
8M16F87OMX	12	1/2	M16x1.5	38.0	22	6.0	5.0	3.3
8M18F87OMX	12	1/2	M18x1.5	39.1	24	5.0	5.0	3.3
10M18F87OMX	14, 15, 16	5/8	M18x1.5	43.1	24	5.0	5.0	3.3
10M22F87OMX	14, 15, 16	5/8	M22x1.5	43.5	27	5.0	5.0	3.3
12M22F87OMX	18, 20	3/4	M22x1.5	48.0	27	5.0	5.0	3.3
12M27F87OMX	18, 20	3/4	M27x2	50.9	32	5.0	5.0	3.3
16M27F87OMX	25	1	M27x2	50.5	36	5.0	5.0	3.3
16M33F87OMX	25	1	M33x2	52.7	41	4.0	4.0	2.6
20M42F87OMX	30, 32	1 1/4	M42x2	55.0	50	4.0	3.0	2.0
24M48F87OMX	38	1 1/2	M48x2	59.4	55	3.0	2.0	1.3

F82EDMX

Male Connector – Metric
37° Flare / Metric-ED



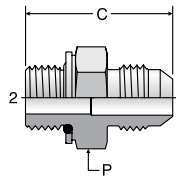
TUBE FITTING PART #	END SIZE			C4 (mm)	L5 (mm)	Dynamic Pressure (x 1,000 PSI)		
	1		Male Metric Parallel Thread			S	SS	B
	(mm)	(in.)						
4M10F82EDMX	6	1/4	M10x1	14	30.0	7.2	5.0	3.3
5M12F82EDMX	8	5/16	M12x1.5	17	34.0	6.0	5.0	3.3
6M14F82EDMX	10	3/8	M14x1.5	19	35.0	6.0	5.0	3.3
6M16F82EDMX	10	3/8	M16x1.5	22	36.0	6.0	5.0	3.3
8M16F82EDMX	12	1/2	M16x1.5	22	38.5	6.0	5.0	3.3
8M18F82EDMX	12	1/2	M18x1.5	24	38.5	5.0	5.0	3.3
10M18F82EDMX	14, 15, 16	5/8	M18x1.5	24	42.5	5.0	5.0	3.3
10M22F82EDMX	14, 15, 16	5/8	M22x1.5	27	44.5	5.0	5.0	3.3
12M22F82EDMX	18, 20	3/4	M22x1.5	27	49.0	5.0	5.0	3.3
12M27F82EDMX	18, 20	3/4	M27x2	32	51.0	5.0	5.0	3.3
16M33F82EDMX	25	1	M33x2	41	54.5	4.0	4.0	2.6
20M42F82EDMX	30, 32	1 1/4	M42x2	50	60.0	4.0	3.0	2.0

TABLE OF CONTENTS

VISUAL INDEX

F80MX

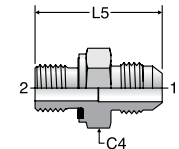
Male Connector – Metric
37° Flare / Metric-ORR



TUBE FITTING PART #	END SIZE			C (mm)	P (mm)	Dynamic Pressure (x 1,000 PSI)		
	1		Male Metric Parallel Thread			S	SS	B
	(mm)	(in.)						
4M10F80MX	6	1/4	M10x1	30.0	14	5.0	5.0	3.3
5M12F80MX	8	5/16	M12x1.5	33.1	19	6.0	6.0	3.3
6M14F80MX	10	3/8	M14x1.5	34.1	19	5.0	5.0	3.3
8M16F80MX	12	1/2	M16x1.5	38.0	22	5.0	5.0	3.3
8M18F80MX	12	1/2	M18x1.5	39.1	24	3.6	3.6	2.3
10M18F80MX	14, 15, 16	5/8	M18x1.5	43.1	24	3.6	3.6	2.3
10M22F80MX	14, 15, 16	5/8	M22x1.5	43.5	27	3.6	3.6	2.3
12M22F80MX	18, 20	3/4	M22x1.5	48.0	27	3.6	3.6	2.3
12M24F80MX	18, 20	3/4	M24x1.5	44.5	30	3.0	3.0	2.0
12M27F80MX	18, 20	3/4	M27x2	50.9	32	3.0	3.0	2.0
16M27F80MX	25	1	M27x2	50.5	36	3.0	3.0	2.0
16M33F80MX	25	1	M33x2	52.7	41	3.0	3.0	2.0
20M42F80MX	30, 32	1 1/4	M42x2	54.9	50	3.0	3.0	2.0
24M48F80MX	38	1 1/2	M48x2	59.4	55	2.0	2.0	1.3

F42EDMX

Male Connector – BSPP
37° Flare / BSPP-ED



TUBE FITTING PART #	END SIZE			C4 (mm)	L5 (mm)	Dynamic Pressure (x 1,000 PSI)		
	1		BSPP			S	SS	B
	(mm)	(in.)						
4F42EDMX	6	1/4	1/8 - 28	14	30.2	7.2	5.0	3.3
4-4F42EDMX	6	1/4	1/4 - 19	19	35.0	6.0	5.0	3.3
4-6F42EDMX	6	1/4	3/8 - 19	22	36.0	6.0	5.0	3.3
4-8F42EDMX	6	1/4	1/2 - 14	27	39.5	5.0	5.0	3.3
5F42EDMX	8	5/16	1/8 - 28	14	30.0	6.0	5.0	3.3
5-4F42EDMX	8	5/16	1/4 - 19	19	35.0	6.0	5.0	3.3
5-6F42EDMX	8	5/16	3/8 - 19	22	36.0	6.0	5.0	3.3
6-2F42EDMX	10	3/8	1/8 - 28	17	31.2	6.0	5.0	3.3
6F42EDMX	10	3/8	1/4 - 19	19	35.0	6.0	5.0	3.3
6-6F42EDMX	10	3/8	3/8 - 19	22	36.0	6.0	5.0	3.3
6-8F42EDMX	10	3/8	1/2 - 14	27	39.5	5.0	5.0	3.3
8F42EDMX	12	1/2	3/8 - 19	22	38.6	6.0	5.0	3.3
8-4F42EDMX	12	1/2	1/4 - 19	19	39.0	6.0	5.0	3.3
8-8F42EDMX	12	1/2	1/2 - 14	27	42.0	5.0	5.0	3.3
8-12F42EDMX	12	1/2	3/4 - 14	32	45.7	5.0	5.0	3.3
10F42EDMX	14, 15, 16	5/8	1/2 - 14	27	45.0	5.0	5.0	3.3
10-6F42EDMX	14, 15, 16	5/8	3/8 - 19	24	43.0	5.0	5.0	3.3
10-12F42EDMX	14, 15, 16	5/8	3/4 - 14	32	48.2	5.0	5.0	3.3
12F42EDMX	18, 20	3/4	3/4 - 14	32	51.0	5.0	5.0	3.3
12-6F42EDMX	18, 20	3/4	3/8 - 19	27	50.0	5.0	5.0	3.3
12-8F42EDMX	18, 20	3/4	1/2 - 14	27	49.0	5.0	5.0	3.3
12-16F42EDMX	18, 20	3/4	1 - 11	41	53.5	4.0	4.0	2.6
16F42EDMX	25	1	1 - 11	41	55.0	4.0	4.0	2.6
16-12F42EDMX	25	1	3/4 - 14	36	53.0	4.0	4.0	2.6
16-20F42EDMX	25	1	1 1/4 - 11	50	59.0	4.0	4.0	2.6
20-16F42EDMX	30, 32	1 1/4	1 - 11	46	62.0	4.0	3.0	2.0
20F42EDMX	30, 32	1 1/4	1 1/4 - 11	50	60.0	4.0	3.0	2.0
20-24F42EDMX	30, 32	1 1/4	1 1/2 - 11	55	64.0	3.0	2.0	1.3
24F42EDMX	38	1 1/2	1 1/2 - 11	55	67.0	3.0	2.0	1.3
24-20F42EDMX	38	1 1/2	1 1/4 - 11	50	62.0	3.0	3.0	2.0

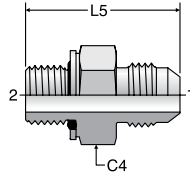
Note: If F80MX is not available, use F82EDMX.

Dimensions and pressures for reference only, subject to change.



F4OMX

Male Connector – BSPP
37° Flare / BSPP-ORR

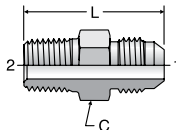


TUBE FITTING PART #	END SIZE			C4 (mm)	L5 (mm)	Dynamic Pressure (x 1,000 PSI)		
	1		2 BSPP			S	SS	B
	(mm)	(in.)						
4F4OMX	6	1/4	1/8 - 28	17	28.3	5.0	5.0	3.3
4-4F4OMX	6	1/4	1/4 - 19	19	32.2	5.0	5.0	3.3
4-6F4OMX	6	1/4	3/8 - 19	22	33.1	5.0	5.0	3.3
4-8F4OMX	6	1/4	1/2 - 14	30	38.6	5.0	5.0	3.3
5-4F4OMX	8	5/16	1/4 - 19	19	32.2	5.0	5.0	3.3
5-6F4OMX	8	5/16	3/8 - 19	22	33.1	5.0	5.0	3.3
6F4OMX	10	3/8	1/4 - 19	19	32.5	5.0	5.0	3.3
6-6F4OMX	10	3/8	3/8 - 19	22	33.4	5.0	5.0	3.3
6-8F4OMX	10	3/8	1/2 - 14	30	38.0	5.0	5.0	3.3
8-4F4OMX	12	1/2	1/4 - 19	19	35.0	5.0	5.0	3.3
8F4OMX	12	1/2	3/8 - 19	22	35.9	5.0	5.0	3.3
8-8F4OMX	12	1/2	1/2 - 14	30	41.4	5.0	5.0	3.3
8-12F4OMX	12	1/2	3/4 - 14	36	42.2	4.0	4.0	2.6
10-6F4OMX	14, 15, 16	5/8	3/8 - 19	24	39.1	5.0	5.0	3.3
10F4OMX	14, 15, 16	5/8	1/2 - 14	30	43.1	5.0	5.0	3.3
12-8F4OMX	18, 20	3/4	1/2 - 14	30	46.7	5.0	5.0	3.3
12F4OMX	18, 20	3/4	3/4 - 14	36	47.5	4.0	3.6	2.3
12-16F4OMX	18, 20	3/4	1 - 11	46	52.6	4.0	3.6	2.3
16-12F4OMX	25	1	3/4 - 14	36	48.5	4.0	3.6	2.3
16F4OMX	25	1	1 - 11	46	53.6	4.0	3.6	2.3
16-20F4OMX	25	1	1 1/4 - 11	50	54.7	3.6	2.5	1.6
20F4OMX	30, 32	1 1/4	1 1/4 - 11	50	56.0	3.6	2.5	1.6
24-20F4OMX	38	1 1/2	1 1/4 - 11	50	60.4	3.0	2.0	1.3
24F4OMX	38	1 1/2	1 1/2 - 11	55	61.1	3.0	2.0	1.3

Note: If F4OMX is not available, use F42EDMX.

F3MX

Male Connector – BSPT
37° Flare / BSPT

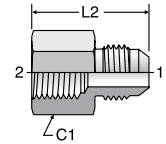


TUBE FITTING PART #	END SIZE			C HEX (mm)	L (mm)	Dynamic Pressure (x 1,000 PSI)		
	1		2 BSPT			S	SS	B
	(mm)	(in.)						
4F3MX	6	1/4	1/8 - 28	13	30.7	4.5	4.5	2.9
4-4F3MX	6	1/4	1/4 - 19	14	35.3	4.5	4.5	2.9
5F3MX	8	5/16	1/8 - 28	14	30.7	4.5	4.5	2.9
5-4F3MX	8	5/16	1/4 - 19	14	35.3	4.5	4.5	2.9
6F3MX	10	3/8	1/4 - 19	17	35.6	4.5	4.5	2.9
6-6F3MX	10	3/8	3/8 - 19	19	36.4	4.5	4.5	2.9
6-8F3MX	10	3/8	1/2 - 14	22	42.9	4.5	4.5	2.9
8-4F3MX	12	1/2	1/4 - 19	19	38.1	4.5	4.5	2.9
8F3MX	12	1/2	3/8 - 19	19	38.9	4.5	4.5	2.9
8-8F3MX	12	1/2	1/2 - 14	22	45.5	4.5	4.5	2.9
10-6F3MX	14, 15, 16	5/8	3/8 - 19	24	43.2	4.5	4.5	2.9
10F3MX	14, 15, 16	5/8	1/2 - 14	24	48.0	4.5	4.5	2.9
10-12F3MX	14, 15, 16	5/8	3/4 - 14	27	48.3	2.3	2.3	1.5
12-8F3MX	18, 20	3/4	1/2 - 14	27	50.8	4.5	4.5	2.9
12F3MX	18, 20	3/4	3/4 - 14	27	50.8	2.3	2.3	1.5
12-16F3MX	18, 20	3/4	1 - 11	36	57.1	2.3	2.3	1.5
16-12F3MX	25	1	3/4 - 14	36	53.6	2.3	2.3	1.5
16F3MX	25	1	1 - 11	36	58.5	2.3	2.3	1.5
20-16F3MX	30, 32	1 1/4	1 - 11	46	61.4	2.3	2.3	1.5
20F3MX	30, 32	1 1/4	1 1/4 - 11	46	62.2	2.3	2.3	1.5
24F3MX	38	1 1/2	1 1/2 - 11	50	68.1	2.3	2.0	1.3

Dimensions and pressures for reference only, subject to change.

G4MX

Female Connector – BSPP
37° Flare / BSPP



TUBE FITTING PART #	END SIZE			C1 (mm)	L2 (mm)	Dynamic Pressure (x 1,000 PSI)		
	1		2 BSPP			S	SS	B
	(mm)	(in.)						
4G4MX	6	1/4	1/8 - 28	17	30.2	4.5	4.5	2.9
4-4G4MX	6	1/4	1/4 - 19	19	35.3	5.8	5.8	3.3
5G4MX	8	5/16	1/8 - 28	17	29.7	4.5	4.5	2.9
6G4MX	10	3/8	1/4 - 19	19	35.6	5.8	5.8	3.3
6-6G4MX	10	3/8	3/8 - 19	22	37.1	5.0	5.0	3.3
8G4MX	12	1/2	3/8 - 19	22	39.6	5.0	5.0	3.3
8-8G4MX	12	1/2	1/2 - 14	30	45.5	5.0	5.0	3.3
10G4MX	14, 15, 16	5/8	1/2 - 14	30	48.0	5.0	5.0	3.3
12G4MX	18, 20	3/4	3/4 - 14	36	52.3	4.5	4.5	2.9
16G4MX	25	1	1 - 11	46	59.7	4.0	4.0	2.6

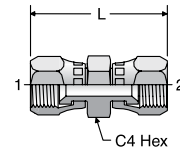
TABLE OF CONTENTS

VISUAL INDEX

B

HX6

Swivel Nut Union
37° Swivel / 37° Swivel



HPD Base # 0606

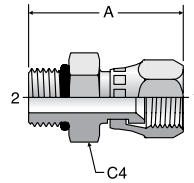
TUBE FITTING PART #	END SIZE		C4 HEX (in.)	L (in.)	Dynamic Pressure (x 1,000 PSI)		
	1 & 2 (in.)				-S	-SS	-B
4 HX6	1/4		9/16	1.48	7.5	7.7	3.3
6 HX6	3/8		11/16	1.75	6.0	6.0	3.3
8 HX6	1/2		7/8	2.02	6.0	6.0	3.3
10 HX6	5/8		1	2.24	5.0	5.0	3.3
12 HX6	3/4		1 1/4	2.31	5.0	5.0	3.3
16 HX6	1		1 1/2	2.75	4.0	3.0	2.6



F650X

Swivel Straight Thread Connector
37° Swivel / SAE-ORB

HPD Base # 0506

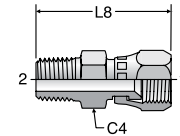


TUBE FITTING PART #	END SIZE		A (in.)	C4 HEX (in.)	Dynamic Pressure (x 1,000 PSI)		
	1 (in.)	2 UN/UNF-2A			-S	-SS	-B
4 F650X	1/4	7/16 - 20	1.31	9/16	7.5	7.5	3.3
4-6 F650X	1/4	9/16 - 18	1.33	11/16	6.0	7.2	3.3
5 F650X	5/16	1/2 - 20	1.39	5/8	6.0	7.2	3.3
6 F650X	3/8	9/16 - 18	1.43	11/16	6.0	7.2	3.3
6-4 F650X	3/8	7/16 - 20	1.37	9/16	6.0	7.2	3.3
6-8 F650X	3/8	3/4 - 16	1.50	7/8	6.0	7.2	3.3
8 F650X	1/2	3/4 - 16	1.61	7/8	6.0	7.2	3.3
8-6 F650X	1/2	9/16 - 18	1.54	13/16	6.0	7.2	3.3
8-10 F650X	1/2	7/8 - 14	1.78	1	5.0	6.0	3.3
10 F650X	5/8	7/8 - 14	1.81	1	5.0	6.0	3.3
10-8 F650X	5/8	3/4 - 16	1.75	1	5.0	6.0	3.3
10-12 F650X	5/8	1 1/16 - 12	1.85	1 1/4	5.0	6.0	3.3
12 F650X	3/4	1 1/16 - 12	2.07	1 1/4	5.0	6.0	3.3
12-10 F650X	3/4	7/8 - 14	2.10	1 1/4	5.0	6.0	3.3
12-16 F650X	3/4	1 5/16 - 12	2.04	1 1/2	4.5	4.5	2.9
16 F650X	1	1 5/16 - 12	2.14	1 1/2	4.0	4.0	2.6
16-12 F650X	1	1 1/16 - 12	2.14	1 1/2	4.0	4.0	2.6
20 F650X	1 1/4	1 5/8 - 12	2.55	2	4.0	4.0	2.6

F6X

Swivel Connector
37° Swivel / NPTF

HPD Base # 0106



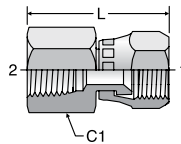
TUBE FITTING PART #	END SIZE		C4 (in.)	L8 (in.)	Dynamic Pressure (x 1,000 PSI)		
	1 (in.)	2 NPTF			-S	-SS	-B
4 F6X	1/4	1/8 - 27	9/16	1.21	6.0	6.0	3.3
4-4 F6X	1/4	1/4 - 18	9/16	1.54	6.0	6.0	3.3
5-4 F6X	5/16	1/4 - 18	5/8	1.60	6.0	6.0	3.3
6 F6X	3/8	1/4 - 18	11/16	1.66	5.0	5.0	3.3
6-6 F6X	3/8	3/8 - 18	3/4	1.69	5.0	5.0	3.3
8 F6X	1/2	3/8 - 18	7/8	1.74	5.0	5.0	3.3
8-8 F6X	1/2	1/2 - 14	7/8	1.97	5.0	5.0	3.3
10 F6X	5/8	1/2 - 14	1	2.05	5.0	5.0	3.3
10-6 F6X	5/8	3/8 - 18	1	1.84	5.0	5.0	3.3
12 F6X	3/4	3/4 - 14	1 1/4	2.15	5.0	5.0	3.3
12-8 F6X	3/4	1/2 - 14	1 1/4	2.15	5.0	5.0	3.3
16 F6X	1	1 - 11 1/2	1 1/2	2.50	3.6	3.6	2.3
16-12 F6X	1	3/4 - 14	1 1/2	2.33	3.6	3.6	2.3
20 F6X	1 1/4	1 1/4 - 11 1/2	2	2.76	3.0	3.0	2.0
24 F6X	1 1/2	1 1/2 - 11 1/2	2 1/4	3.05	2.5	2.5	1.6
32 F6X	2	2 - 11 1/2	2 5/8	3.53	2.0	2.0	1.3

TABLE OF CONTENTS
VISUAL INDEX

G6X

Swivel Nut Female Connector
37° Swivel / NPTF

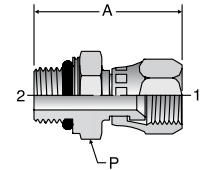
HPD Base # 0206



TUBE FITTING PART #	END SIZE		C1 (in.)	L (in.)	Dynamic Pressure (x 1,000 PSI)		
	1 (in.)	2 NPTF			-S	-SS	-B
4 G6X	1/4	1/8 - 27	9/16	1.27	6.0	6.0	3.3
4-4 G6X	1/4	1/4 - 18	3/4	1.43	6.0	6.0	3.3
6 G6X	3/8	1/4 - 18	3/4	1.44	5.0	5.0	3.3
6-6 G6X	3/8	3/8 - 18	7/8	1.54	5.0	5.0	3.3
6-8 G6X	3/8	1/2 - 14	1 1/8	1.80	5.0	5.0	3.3
8 G6X	1/2	3/8 - 18	7/8	1.69	5.0	5.0	3.3
8-8 G6X	1/2	1/2 - 14	1 1/8	1.94	5.0	5.0	3.3
10 G6X	5/8	1/2 - 14	1 1/8	1.98	5.0	5.0	3.3
12 G6X	3/4	3/4 - 14	1 3/8	2.01	4.0	4.0	2.6
12-8 G6X	3/4	1/2 - 14	1 1/4	2.00	5.0	5.0	3.3
16 G6X	1	1 - 11 1/2	1 5/8	2.48	3.0	3.0	2.0
20 G6X	1 1/4	1 1/4 - 11 1/2	2	2.86	2.5	2.5	1.6
24 G6X	1 1/2	1 1/2 - 11 1/2	2 3/8	3.01	2.0	2.0	1.3
32 G6X	2	2 - 11 1/2	2 7/8	3.40	1.5	1.5	1.0

F6870MX

Swivel - ISO 6149 Connector
37° Swivel / ISO 6149

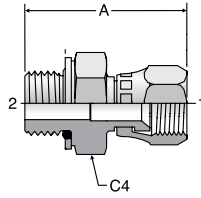


TUBE FITTING PART #	END SIZE		A (mm)	P (mm)	Dynamic Pressure (x 1,000 PSI)		
	1 (mm)	2 Male Metric Parallel Thread (in.)			S	SS	B
4M10F6870MX	6	1/4 M10x1	31.9	14	7.2	5.0	3.3
5M12F6870MX	8	5/16 M12x1.5	35.6	17	6.0	5.0	3.3
6M14F6870MX	10	3/8 M14x1.5	37.2	19	5.0	5.0	3.3
8M16F6870MX	12	1/2 M16x1.5	41.8	22	5.0	5.0	3.3
10M22F6870MX	14, 15, 16	5/8 M22x1.5	47.6	27	5.0	5.0	3.3
12M27F6870MX	18, 20	3/4 M27x2	51.7	32	5.0	5.0	3.3
16M33F6870MX	25	1 M33x2	56.9	41	3.6	3.6	2.3

Dimensions and pressures for reference only, subject to change.

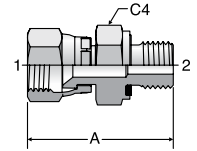
F68OMX

Swivel Metric ORR Connector
Metric-ORR / 37° Swivel



F682EDMX

Metric-ED / 37° Swivel



B

TUBE FITTING PART #	END SIZE			A (mm)	C4 (mm)	Dynamic Pressure (x 1,000 PSI)		
	1		2 Male Metric Parallel Thread			S	SS	B
	(mm)	(in.)						
4M10F68OMX	6	1/4	M10x1	30.2	14	5.0	5.0	3.3
5M12F68OMX	8	5/16	M12x1.5	35.6	17	6.0	6.0	3.3
6M14F68OMX	10	3/8	M14x1.5	37.2	19	5.0	5.0	3.3
8M16F68OMX	12	1/2	M16x1.5	42.4	22	3.6	3.6	2.3
10M22F68OMX	14, 15, 16	5/8	M22x1.5	47.9	27	3.6	3.6	2.3
12M27F68OMX	18, 20	3/4	M27x2	52.3	32	3.0	3.0	2.0
16M33F68OMX	25	1	M33x2	57.4	41	3.0	3.0	2.0

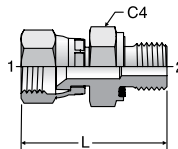
TUBE FITTING PART #	END SIZE			A (mm)	C4 (mm)	Dynamic Pressure (x 1,000 PSI)		
	1		2 Male Metric Parallel Thread			S	SS	B
	(mm)	(in.)						
4M10F682EDMX	6	1/4	M10x1	29.7	14	7.2	5.0	3.3
5M12F682EDMX	8	5/16	M12x1.5	36.6	17	6.0	5.0	3.3
6M14F682EDMX	10	3/8	M14x1.5	38.2	19	5.0	5.0	3.3
8M16F682EDMX	12	1/2	M16x1.5	42.3	22	5.0	5.0	3.3
10M22F682EDMX	14, 15, 16	5/8	M22x1.5	48.6	27	5.0	5.0	3.3
12M27F682EDMX	18, 20	3/4	M27x2	51.7	32	5.0	5.0	3.3
16M33F682EDMX	25	1	M33x2	59.0	41	3.6	3.6	2.3

TABLE OF CONTENTS

VISUAL INDEX

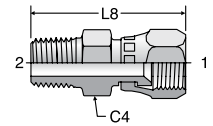
F642EDMX

Swivel – BSPP Connector
37° Swivel / BSPP-ED



F63MX

Swivel – BSPT Connector
37° Swivel / BSPT



TUBE FITTING PART #	END SIZE			C4 (mm)	L (mm)	Dynamic Pressure (x 1,000 PSI)		
	1		2 BSPP			S	SS	B
	(mm)	(in.)						
4F642EDMX	6	1/4	1/8 - 28	14	29.7	7.2	5.0	3.3
4-4F642EDMX	6	1/4	1/4 - 19	19	35.2	6.0	5.0	3.3
5F642EDMX	8	5/16	1/8 - 28	14	32.8	6.0	5.0	3.3
5-4F642EDMX	8	5/16	1/4 - 19	19	37.2	6.0	6.0	3.3
6F642EDMX	10	3/8	1/4 - 19	19	38.7	5.0	5.0	3.3
6-6F642EDMX	10	3/8	3/8 - 19	22	39.2	5.0	5.0	3.3
8F642EDMX	12	1/2	3/8 - 19	22	42.3	5.0	5.0	3.3
8-4F642EDMX	12	1/2	1/4 - 19	19	42.3	5.0	5.0	3.3
10F642EDMX	14, 15, 16	5/8	1/2 - 14	27	48.6	5.0	5.0	3.3
10-6F642EDMX	14, 15, 16	5/8	3/8 - 19	22	46.6	5.0	5.0	3.3
12F642EDMX	18, 20	3/4	3/4 - 14	32	51.7	5.0	5.0	3.3
12-8F642EDMX	18, 20	3/4	1/2 - 14	27	49.7	5.0	5.0	3.3
16F642EDMX	25	1	1 - 11	41	59.0	3.6	3.6	2.3
16-12F642EDMX	25	1	3/4 - 14	32	57.0	3.6	3.6	2.3
20F642EDMX	28, 30, 32	1 1/4	1 1/4 - 11	50	63.4	3.6	3.0	2.0
20-16F642EDMX	28, 30, 32	1 1/4	1 - 11	41	65.9	3.6	3.0	2.0
24F642EDMX	35, 38	1 1/2	1 1/2 - 11	55	74.1	2.5	2.0	1.3
24-20F642EDMX	35, 38	1 1/2	1 1/4 - 11	50	69.1	2.5	2.0	1.3

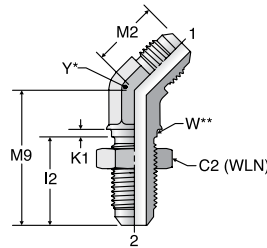
TUBE FITTING PART #	END SIZE			C4 (mm)	L8 (mm)	Dynamic Pressure (x 1,000 PSI)		
	1		2 BSPT			S	SS	B
	(mm)	(in.)						
4F63MX	6	1/4	1/8 - 20	13	31.0	4.5	4.5	2.9
4-4F63MX	6	1/4	1/4 - 19	14	35.7	4.5	4.5	2.9
5-4F63MX	8	5/16	1/4 - 19	14	38.4	4.5	4.5	2.9
6F63MX	10	3/8	1/4 - 19	14	39.7	4.5	4.5	2.9
6-6F63MX	10	3/8	3/8 - 19	19	39.7	4.5	4.5	2.9
8-4F63MX	12	1/2	1/4 - 19	19	42.8	4.5	4.5	2.9
8F63MX	12	1/2	3/8 - 19	19	42.8	4.5	4.5	2.9
10F63MX	14, 15, 16	5/8	1/2 - 14	22	51.2	4.5	4.5	2.9
12-8F63MX	20	3/4	1/2 - 14	27	53.2	4.5	4.5	2.9
12F63MX	18, 20	3/4	3/4 - 14	27	53.2	2.3	2.3	1.5
16-12F63MX	25	1	3/4 - 14	32	55.7	2.3	2.3	1.5
16F63MX	25	1	1 - 11	36	62.5	2.3	2.3	1.5
20F63MX	30, 32	1 1/4	1 1/4 - 11	46	70.6	2.3	2.3	1.5

Dimensions and pressures for reference only, subject to change.

WNTX

45° Bulkhead Union Elbow
37° Flare / 37° Flare

SAE 070801
HPD Base # 3353
WNTX-WLN – Body with locknut
(See page B10 for WLN)



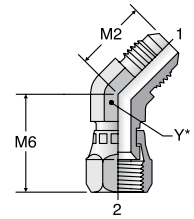
Y* – Across wrench flats.
W** – Bulkhead pilot dia.
recommended clearance hole
+.015 over W dia.

TUBE FITTING PART #	END SIZE		C2 HEX (in.)	I2 (in.)	K1 (in.)	M2 (in.)	M9 (in.)	W DIA (in.)	MAX BULKHEAD WALL THICKNESS (in.)	Y (in.)	Dynamic Pressure (x 1,000 PSI)		
	1 & 2 (in.)										-S	-SS	-B
4 WNTX	1/4	11/16	1.02	0.09	0.72	1.53	0.44	0.25	7/16	7.5	7.7	3.3	
5 WNTX	5/16	3/4	1.02	0.09	0.77	1.66	0.56	0.25	9/16	6.0	6.0	3.3	
6 WNTX	3/8	13/16	1.09	0.09	0.83	1.67	0.56	0.35	9/16	6.0	6.0	3.3	
8 WNTX	1/2	1	1.25	0.13	0.98	1.94	0.75	0.35	3/4	6.0	6.0	3.3	
10 WNTX	5/8	1 1/8	1.39	0.13	1.11	2.17	0.82	0.35	7/8	5.0	5.0	3.3	
12 WNTX	3/4	1 3/8	1.56	0.13	1.28	2.44	1.06	0.35	1 1/16	5.0	5.0	2.9	
16 WNTX	1	1 5/8	1.56	0.13	1.47	2.56	1.31	0.35	1 5/16	4.0	3.5	2.3	
20 WNTX	1 1/4	1 7/8	1.61	0.13	1.59	2.66	1.63	0.35	1 5/8	4.0	3.0	2.0	

V6X

45° Swivel Nut Elbow
37° Flare / 37° Swivel

SAE 070321
HPD Base # 3703



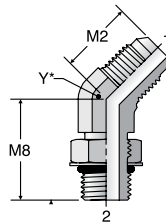
Y* – Across wrench flats

TUBE FITTING PART #	END SIZE		M2 (in.)	M6 (in.)	Y (in.)	Dynamic Pressure (x 1,000 PSI)		
	1 & 2 (in.)					-S	-SS	-B
4 V6X	1/4		0.72	0.94	7/16	7.5	7.7	3.3
5 V6X	5/16		0.77	1.00	9/16	6.0	6.0	3.3
6 V6X	3/8		0.83	1.12	9/16	6.0	6.0	3.3
8 V6X	1/2		0.98	1.28	3/4	6.0	6.0	3.3
10 V6X	5/8		1.11	1.44	7/8	5.0	5.0	3.3
12 V6X	3/4		1.28	1.50	1 1/16	5.0	5.0	3.3
14 V6X	7/8		1.45	1.62	1 3/16	5.0	5.0	3.3
16 V6X	1		1.47	1.75	1 5/16	4.0	3.0	2.6
20 V6X	1 1/4		1.59	2.03	1 5/8	4.0	3.0	2.6
24 V6X	1 1/2		1.78	2.18	1 7/8	3.0	2.5	2.0
32 V6X	2		2.22	2.76	2 1/2	2.0	1.5	1.3

V50X

45° Straight Thread Elbow
37° Flare / SAE-ORB

SAE 070320
HPD Base # 3503

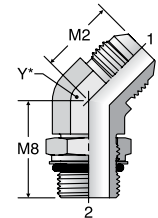


Y* – Across wrench flats

TUBE FITTING PART #	END SIZE		M2 (in.)	M8 (in.)	Y (in.)	Dynamic Pressure (x 1,000 PSI)		
	1 (in.)	2 UN/UNF-2A				-S	-SS	-B
4 V50X	1/4	7/16 - 20	0.72	1.05	7/16	6.0	6.0	3.3
4-6 V50X	1/4	9/16 - 18	0.82	1.14	9/16	6.0	5.4	3.3
5 V50X	5/16	1/2 - 20	0.77	1.05	9/16	6.0	5.4	3.3
6 V50X	3/8	9/16 - 18	0.83	1.14	9/16	6.0	5.4	3.3
6-4 V50X	3/8	7/16 - 20	0.83	1.08	9/16	6.0	5.4	3.3
6-8 V50X	3/8	3/4 - 16	0.86	1.30	3/4	6.0	5.4	3.3
8 V50X	1/2	3/4 - 16	0.98	1.30	3/4	6.0	5.4	3.3
8-6 V50X	1/2	9/16 - 18	0.98	1.09	3/4	6.0	5.4	3.3
8-10 V50X	1/2	7/8 - 14	1.00	1.52	7/8	5.0	5.4	3.3
8-12 V50X	1/2	1 1/16 - 12	1.04	1.73	1 1/16	5.0	5.4	3.3
10 V50X	5/8	7/8 - 14	1.11	1.52	7/8	5.0	5.4	3.3
10-8 V50X	5/8	3/4 - 16	1.11	1.38	7/8	5.0	5.4	3.3
10-12 V50X	5/8	1 1/16 - 12	1.16	1.73	1 1/16	5.0	5.4	3.3
12 V50X	3/4	1 1/16 - 12	1.28	1.73	1 1/16	5.0	5.4	3.3
12-10 V50X	3/4	7/8 - 14	1.28	1.58	1 1/16	5.0	5.4	3.3
12-16 V50X	3/4	1 5/16 - 12	1.42	1.86	1 5/16	4.0	3.0	2.6
14 V50X	7/8	1 3/16 - 12	1.45	1.86	1 5/16	5.0	5.4	3.3
16 V50X	1	1 5/16 - 12	1.47	1.86	1 5/16	4.0	3.0	2.6
16-12 V50X	1	1 1/16 - 12	1.47	1.86	1 5/16	4.0	3.0	2.6
16-20 V50X	1	1 5/8 - 12	1.55	1.91	1 5/8	3.0	2.5	2.0
20 V50X	1 1/4	1 5/8 - 12	1.59	1.91	1 5/8	3.0	2.5	2.0
20-16 V50X	1 1/4	1 5/16 - 12	1.59	1.91	1 5/8	4.0	2.5	2.0
24 V50X	1 1/2	1 7/8 - 12	1.78	1.91	1 7/8	3.0	2.0	1.5
32 V50X	2	2 1/2 - 12	2.22	1.86	2 1/2	2.0	1.5	1.3

V870MX

Male 45° Elbow – ISO 6149
37° Flare / ISO 6149



Y* – Across wrench flats

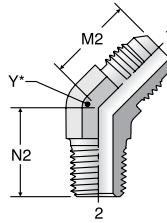
TUBE FITTING PART #	END SIZE		M2 (mm)	M8 (mm)	Y (mm)	Dynamic Pressure (x 1,000 PSI)			
	1 (mm)	2 Male Metric Parallel Thread (in.)				S	SS	B	
4M12V870MX	6	1/4	M12X1.5	19.6	27.0	13	6.0	6.0	3.3
6M14V870MX	10	3/8	M14X1.5	21.1	28.0	14	6.0	6.0	3.3
8M16V870MX	12	1/2	M16 X 1.5	24.9	33.0	19	5.0	5.0	3.3
10M22V870MX	14, 15, 16	5/8	M22 X 1.5	28.2	37.5	22	5.0	5.0	3.3
12M27V870MX	18, 20	3/4	M27 X 2.0	32.5	46.0	27	5.0	5.0	3.3
16M33V870MX	25	1	M33 X 2.0	37.3	45.5	33	4.0	4.0	2.6

Dimensions and pressures for reference only, subject to change.

VTX

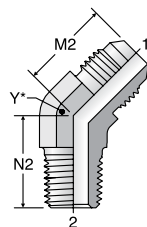
45° Male Elbow
37° Flare / NPTF

SAE 070302
HPD Base # 3103



Y* – Across wrench flats

TUBE FITTING PART #	END SIZE		M2 (in.)	N2 (in.)	Y (in.)	Dynamic Pressure (x 1,000 PSI)		
	1 (in.)	2 NPTF				-S	-SS	-B
	2 VTX	1/8						
3 VTX	3/16	1/8 - 27	0.69	0.52	7/16	6.0	6.0	3.3
4 VTX	1/4	1/8 - 27	0.72	0.64	7/16	6.0	6.0	3.3
4-4 VTX	1/4	1/4 - 18	0.82	0.86	9/16	6.0	6.0	3.3
4-6 VTX	1/4	3/8 - 18	0.85	0.95	3/4	6.0	6.0	3.3
5 VTX	5/16	1/8 - 27	0.77	0.64	9/16	6.0	6.0	3.3
5-4 VTX	5/16	1/4 - 18	0.82	0.86	9/16	6.0	6.0	3.3
6 VTX	3/8	1/4 - 18	0.83	0.86	9/16	6.0	6.0	3.3
6-2 VTX	3/8	1/8 - 27	0.83	0.67	9/16	6.0	6.0	3.3
6-6 VTX	3/8	3/8 - 18	0.87	0.95	3/4	6.0	6.0	3.3
6-8 VTX	3/8	1/2 - 14	0.88	1.17	7/8	6.0	6.0	3.3
8 VTX	1/2	3/8 - 18	0.98	0.95	3/4	6.0	6.0	3.3
8-4 VTX	1/2	1/4 - 18	0.98	0.95	3/4	6.0	6.0	3.3
8-8 VTX	1/2	1/2 - 14	0.99	1.17	7/8	6.0	6.0	3.3
8-12 VTX	1/2	3/4 - 14	1.04	1.20	1 1/16	4.0	4.0	2.6
10 VTX	5/8	1/2 - 14	1.11	1.17	7/8	5.0	5.0	3.3
10-6 VTX	5/8	3/8 - 18	1.11	0.98	7/8	5.0	5.0	3.3
10-12 VTX	5/8	3/4 - 14	1.28	1.20	1 1/16	4.0	4.0	2.6
12 VTX	3/4	3/4 - 14	1.28	1.20	1 1/16	4.0	4.0	2.6
12-8 VTX	3/4	1/2 - 14	1.28	1.20	1 1/16	5.0	5.0	2.9
12-16 VTX	3/4	1 - 11 1/2	1.42	1.49	1 5/16	3.0	3.0	2.0
14 VTX	7/8	3/4 - 14	1.45	1.30	1 5/16	4.0	4.0	2.3
16 VTX	1	1 - 11 1/2	1.47	1.48	1 5/16	3.0	3.0	2.0
16-12 VTX	1	3/4 - 14	1.47	1.29	1 5/16	4.0	4.0	2.3
16-20 VTX	1	1 1/4 - 11 1/2	1.59	1.67	1 5/8	2.5	2.5	1.6
20 VTX	1 1/4	1 1/4 - 11 1/2	1.59	1.67	1 5/8	2.5	2.5	1.6
20-16 VTX	1 1/4	1 - 11 1/2	1.59	1.63	1 5/8	3.0	3.0	2.0
24 VTX	1 1/2	1 1/2 - 11 1/2	1.78	1.77	1 7/8	2.5	2.5	1.6
32 VTX	2	2 - 11 1/2	2.22	2.11	2 1/2	2.0	2.0	1.3



Y* – Across wrench flats

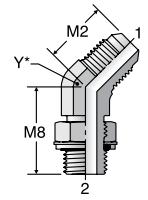
V3MX

Male 45° Elbow – BSPT
37° Flare / BSPT

TUBE FITTING PART #	END SIZE		M2 (mm)	N2 (mm)	Y (mm)	Dynamic Pressure (x 1,000 PSI)			
	1 (mm)	2 (in.) BSPT				S	SS	B	
	4V3MX	6							1/4
4-4V3MX	6	1/4	1/4 - 19	20.8	21.8	14	4.5	4.5	2.9
6V3MX	10	3/8	1/4 - 19	21.1	21.8	14	4.5	4.5	2.9
6-6V3MX	10	3/8	3/8 - 19	22.1	24.1	19	4.5	4.5	2.9
8V3MX	12	1/2	3/8 - 19	24.9	24.1	19	4.5	4.5	2.9
8-8V3MX	12	1/2	1/2 - 14	25.2	29.7	22	4.5	4.5	2.9
12V3MX	18, 20	3/4	3/4 - 14	32.5	30.5	27	2.3	2.3	1.5

V40MX

Male 45° Elbow – BSPP
37° Flare / BSPP-ORR



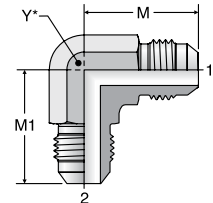
Y* – Across wrench flats

TUBE FITTING PART #	END SIZE		M2 (mm)	M8 (mm)	Y (mm)	Dynamic Pressure (x 1,000 PSI)			
	1 (mm)	2 (in.) BSPP				S	SS	B	
	4V40MX	6							1/4
6V40MX	10	3/8	1/4 - 19	21.1	29.0	14	3.6	3.6	2.3
8V40MX	12	1/2	3/8 - 19	24.9	33.0	19	3.6	3.6	2.3
10V40MX	14,15,16	5/8	1/2 - 14	28.2	38.5	22	3.6	3.6	2.3
12V40MX	18,20	3/4	3/4 - 14	32.5	44.0	27	3.6	3.6	2.3
16V40MX	25	1	1 - 11	37.3	47.0	33	3.6	3.6	2.3

ETX

Union Elbow
37° Flare / 37° Flare

SAE 070201
HPD Base # 2303



Y* – Across wrench flats

TUBE FITTING PART #	END SIZE		M (in.)	M1 (in.)	Y (in.)	Dynamic Pressure (x 1,000 PSI)		
	1 (in.)	2 (in.)				-S	-SS	-B
	2 ETX	1/8						
3 ETX	3/16	3/16	0.83	0.83	7/16	7.5	7.7	3.3
4 ETX	1/4	1/4	0.89	0.89	7/16	7.5	7.7	3.3
5 ETX	5/16	5/16	0.97	0.97	9/16	6.0	6.0	3.3
6 ETX	3/8	3/8	1.06	1.06	9/16	6.0	6.0	3.3
6-4 ETX	3/8	1/4	1.06	1.05	9/16	6.0	6.0	3.3
8 ETX	1/2	1/2	1.25	1.25	3/4	6.0	6.0	3.3
8-6 ETX	1/2	3/8	1.25	1.14	3/4	6.0	6.0	3.3
10 ETX	5/8	5/8	1.45	1.45	7/8	5.0	5.0	3.3
10-8 ETX	5/8	1/2	1.45	1.33	7/8	5.0	5.0	3.3
12 ETX	3/4	3/4	1.66	1.66	1 1/16	5.0	5.0	3.3
12-8 ETX	3/4	1/2	1.66	1.42	1 1/16	5.0	5.0	3.3
12-10 ETX	3/4	5/8	1.66	1.54	1 1/16	5.0	5.0	3.3
14 ETX	7/8	7/8	1.80	1.80	1 3/16	5.0	5.0	3.3
16 ETX	1	1	1.81	1.81	1 5/16	4.0	3.5	2.3
16-12 ETX	1	3/4	1.81	1.77	1 5/16	4.0	3.5	2.3
20 ETX	1 1/4	1 1/4	2.06	2.06	1 5/8	4.0	3.0	2.0
24 ETX	1 1/2	1 1/2	2.33	2.33	1 7/8	3.0	2.0	1.3
32 ETX	2	2	3.06	3.06	2 1/2	2.0	1.5	1.0

Dimensions and pressures for reference only, subject to change.



B

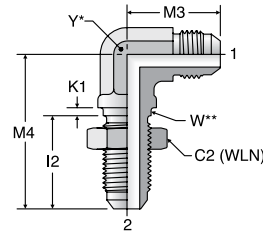
TABLE OF CONTENTS

VISUAL INDEX

WETX

Bulkhead Union Elbow
37° Flare / 37° Flare

SAE 070701
HPD Base # 2353
WETX-WLN – Body with locknut
(See page B10 for WLN)



Y* – Across wrench flats.
W** – Bulkhead pilot dia.
recommended clearance hole
+.015 over W dia.

TABLE
OF
CONTENTS

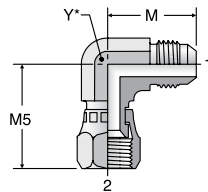
VISUAL
INDEX

TUBE FITTING PART #	END SIZE		C2 HEX (in.)	I2 (in.)	K1 (in.)	M3 (in.)	M4 (in.)	W DIA (in.)	MAX BULKHEAD WALL THICKNESS (in.)	Y (in.)	Dynamic Pressure (x 1,000 PSI)		
	1 & 2 (in.)										-S	-SS	-B
3 WETX	3/16		5/8	0.92	0.09	0.94	1.50	0.38	0.25	7/16	7.5	7.7	3.3
4 WETX	1/4		11/16	1.02	0.09	0.97	1.59	0.44	0.25	7/16	7.5	7.7	3.3
5 WETX	5/16		3/4	1.02	0.09	1.06	1.72	0.50	0.25	9/16	6.0	6.0	3.3
6 WETX	3/8		13/16	1.09	0.09	1.09	1.81	0.56	0.35	9/16	6.0	6.0	3.3
8 WETX	1/2		1	1.25	0.13	1.36	2.11	0.75	0.35	3/4	6.0	6.0	3.3
10 WETX	5/8		1 1/8	1.39	0.13	1.56	2.39	0.88	0.35	7/8	5.0	5.0	3.3
12 WETX	3/4		1 3/8	1.56	0.13	1.78	2.67	1.06	0.35	1 1/16	5.0	5.0	3.3
14 WETX	7/8		1 1/2	1.56	0.13	1.92	2.80	1.19	0.35	1 5/8	5.0	5.0	3.3
16 WETX	1		1 5/8	1.56	0.13	1.94	2.80	1.31	0.35	1 5/8	4.0	3.5	2.3
20 WETX	1 1/4		1 7/8	1.61	0.13	2.17	3.13	1.63	0.35	1 5/8	4.0	3.0	2.0

C6X

Swivel Nut Elbow
37° Flare / 37° Swivel

SAE 070221
HPD Base # 3903

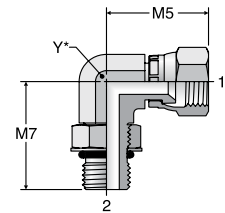


Y* – Across wrench flats

AOEX6

Swivel Elbow Straight
Thread Connector
SAE-ORB / 37° Swivel

HPD Base # 2506



Y* – Across wrench flats

TUBE FITTING PART #	END SIZE		M (in.)	M5 (in.)	Y (in.)	Dynamic Pressure (x 1,000 PSI)		
	1 (in.)	2 (in.)				-S	-SS	-B
3 C6X	3/16	3/16	0.83	1.00	7/16	7.5	7.7	3.3
4 C6X	1/4	1/4	0.89	1.00	7/16	7.5	7.7	3.3
5 C6X	5/16	5/16	0.95	1.06	9/16	6.0	6.0	3.3
6 C6X	3/8	3/8	1.06	1.25	9/16	6.0	6.0	3.3
8 C6X	1/2	1/2	1.25	1.38	3/4	6.0	6.0	3.3
10 C6X	5/8	5/8	1.45	1.62	7/8	5.0	5.0	3.3
12 C6X	3/4	3/4	1.66	1.75	1 1/16	5.0	5.0	3.3
12-24 C6X	3/4	1 1/2	2.11	2.59	1 7/8	3.0	2.5	2.0
14 C6X	7/8	7/8	1.81	1.78	1 5/16	5.0	5.0	3.3
16 C6X	1	1	1.81	2.00	1 5/16	4.0	3.0	2.6
16-12 C6X	1	3/4	1.81	1.87	1 5/16	4.0	3.0	2.6
20 C6X	1 1/4	1 1/4	2.06	2.31	1 5/8	4.0	3.0	2.6
24 C6X	1 1/2	1 1/2	2.33	2.59	1 7/8	3.0	2.5	2.0
32 C6X	2	2	3.06	3.51	2 1/2	2.0	1.5	1.3

TUBE FITTING PART #	END SIZE		M5 (in.)	M7 (in.)	Y (in.)	Dynamic Pressure (x 1,000 PSI)		
	1 (in.)	2 UN/UNF-2A				-S	-SS	-B
4 AOEX6	1/4	7/16 - 20	1.00	1.03	7/16	6.0	6.0	3.3
6 AOEX6	3/8	9/16 - 18	1.25	1.25	9/16	6.0	6.0	3.3
8 AOEX6	1/2	3/4 - 16	1.38	1.45	3/4	6.0	6.0	3.3
10 AOEX6	5/8	7/8 - 14	1.62	1.70	7/8	5.0	5.0	3.3
12 AOEX6	3/4	1 1/16 - 12	1.75	1.94	1 1/16	5.0	5.0	3.3
16 AOEX6	1	1 5/16 - 12	2.00	2.05	1 5/16	4.0	3.0	2.6

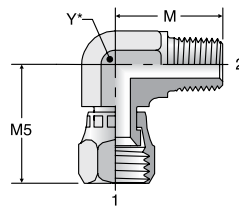
Dimensions and pressures for reference only, subject to change.



X6EF

Swivel Elbow Connector
37° Swivel / NPTF

HPD Base # 2106



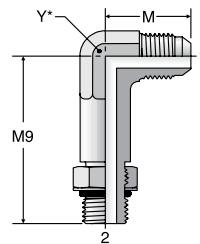
Y* – Across wrench flats

TUBE FITTING PART #	END SIZE		M (in.)	M5 (in.)	Y (in.)	Dynamic Pressure (x 1,000 PSI)		
	1 (in.)	2 NPTF				-S	-SS	-B
4 X6EF	1/4	1/8 - 27	0.78	1.01	7/16	6.0	6.0	3.3
4-4 X6EF	1/4	1/4 - 18	1.09	1.13	9/16	6.0	6.0	3.3
6 X6EF	3/8	1/4 - 18	1.09	1.25	9/16	6.0	6.0	3.3
6-6 X6EF	3/8	3/8 - 18	1.22	1.27	3/4	6.0	6.0	3.3
8 X6EF	1/2	3/8 - 18	1.22	1.38	3/4	6.0	6.0	3.3
8-8 X6EF	1/2	1/2 - 14	1.47	1.48	7/8	6.0	6.0	3.3
10 X6EF	5/8	1/2 - 14	1.47	1.62	7/8	5.0	5.0	3.3
12 X6EF	3/4	3/4 - 14	1.59	1.75	1 1/16	4.0	4.0	2.6
16 X6EF	1	1 - 11	1.97	2.01	1 5/16	3.0	3.0	2.0

CC50X

Long Straight Thread Elbow
37° Flare / SAE-ORB

SAE 071620
HPD Base # 5503



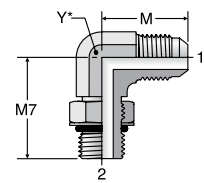
Y* – Across wrench flats

TUBE FITTING PART #	END SIZE		M (in.)	M9 (in.)	Y (in.)	Dynamic Pressure (x 1,000 PSI)		
	1 (in.)	2 UN/UNF-2A				-S	-SS	-B
4 CC50X	1/4	7/16 - 20	0.89	1.73	9/16	6.0	6.0	3.3
6 CC50X	3/8	9/16 - 18	1.06	2.08	9/16	6.0	5.4	3.3
8 CC50X	1/2	3/4 - 16	1.25	2.50	7/8	6.0	5.4	3.3
10 CC50X	5/8	7/8 - 14	1.45	2.89	7/8	5.0	5.4	3.3
12 CC50X	3/4	1 1/16 - 12	1.66	3.34	1 1/16	5.0	5.4	3.3
16 CC50X	1	1 5/16 - 12	1.81	3.72	1 5/16	4.0	3.0	2.6

C50X

Straight Thread Elbow
37° Flare / SAE-ORB

SAE 070220
HPD Base # 2503



Y* – Across wrench flats

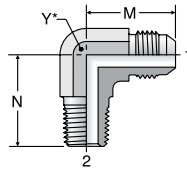
TUBE FITTING PART #	END SIZE		M (in.)	M7 (in.)	Y (in.)	Dynamic Pressure (x 1,000 PSI)		
	1 (in.)	2 UN/UNF-2A				-S	-SS	-B
2 C50X	1/8	5/16 - 24	0.77	0.94	7/16	5.0	6.0	3.3
3 C50X	3/16	3/8 - 24	0.83	0.94	7/16	5.0	6.0	3.3
4 C50X	1/4	7/16 - 20	0.89	1.03	7/16	6.0	6.0	3.3
4-2 C50X	1/4	5/16 - 24	0.89	0.92	7/16	5.0	6.0	3.3
4-6 C50X	1/4	9/16 - 18	1.05	1.25	9/16	6.0	5.4	3.3
4-8 C50X	1/4	3/4 - 16	1.13	1.45	3/4	6.0	5.4	3.3
5 C50X	5/16	1/2 - 20	0.95	1.13	9/16	6.0	5.4	3.3
5-4 C50X	5/16	7/16 - 20	0.95	1.13	9/16	6.0	5.4	3.3
5-6 C50X	5/16	9/16 - 18	1.06	1.25	9/16	6.0	5.4	3.3
6 C50X	3/8	9/16 - 18	1.06	1.25	9/16	6.0	5.4	3.3
6-4 C50X	3/8	7/16 - 20	1.06	1.19	9/16	6.0	5.4	3.3
6-5 C50X	3/8	1/2 - 20	1.06	1.19	9/16	6.0	5.4	3.3
6-8 C50X	3/8	3/4 - 16	1.14	1.45	3/4	6.0	5.4	3.3
6-10 C50X	3/8	7/8 - 14	1.23	1.70	7/8	6.0	5.4	3.3
8 C50X	1/2	3/4 - 16	1.25	1.45	3/4	6.0	5.4	3.3
8-4 C50X	1/2	7/16 - 20	1.25	1.26	3/4	6.0	5.4	3.3
8-6 C50X	1/2	9/16 - 18	1.25	1.34	3/4	6.0	5.4	3.3
8-10 C50X	1/2	7/8 - 14	1.33	1.70	7/8	5.0	5.4	3.3
8-12 C50X	1/2	1 1/16 - 12	1.42	1.94	1 1/16	5.0	5.4	3.3
8-16 C50X	1/2	1 5/16 - 12	1.52	2.05	1 5/16	4.0	3.0	2.6
10 C50X	5/8	7/8 - 14	1.45	1.70	7/8	5.0	5.4	3.3
10-6 C50X	5/8	9/16 - 18	1.45	1.41	7/8	5.0	5.4	3.3
10-8 C50X	5/8	3/4 - 16	1.45	1.55	7/8	5.0	5.4	3.3
10-12 C50X	5/8	1 1/16 - 12	1.53	1.94	1 1/16	5.0	5.4	3.3
10-16 C50X	5/8	1 5/16 - 12	1.64	2.05	1 5/16	4.0	3.0	2.6
12 C50X	3/4	1 1/16 - 12	1.66	1.94	1 1/16	5.0	5.4	3.3
12-8 C50X	3/4	3/4 - 16	1.66	1.63	1 1/16	5.0	5.4	3.3
12-10 C50X	3/4	7/8 - 14	1.66	1.78	1 1/16	5.0	5.4	3.3
12-14 C50X	3/4	1 3/16 - 12	1.77	2.00	1 5/16	5.0	5.4	3.3
12-16 C50X	3/4	1 5/16 - 12	1.76	2.05	1 5/16	4.0	3.0	2.6
12-20 C50X	3/4	1 5/8 - 12	1.97	2.25	1 5/8	3.0	3.0	2.6
14 C50X	7/8	1 3/16 - 12	1.80	2.05	1 5/16	5.0	5.4	3.3
16 C50X	1	1 5/16 - 12	1.81	2.05	1 5/16	4.0	3.0	2.6
16-12 C50X	1	1 1/16 - 12	1.81	2.05	1 5/16	4.0	3.0	2.6
16-14 C50X	1	1 3/16 - 12	1.81	2.05	1 5/16	4.0	3.0	2.6
16-20 C50X	1	1 5/8 - 12	2.01	2.25	1 5/8	3.0	2.5	2.0
16-24 C50X	1	1 7/8 - 12	2.16	2.39	1 7/8	3.0	2.5	2.0
20 C50X	1 1/4	1 5/8 - 12	2.06	2.25	1 5/8	3.0	2.5	2.0
20-16 C50X	1 1/4	1 5/16 - 12	2.06	2.25	1 5/8	4.0	2.5	2.0
20-24 C50X	1 1/4	1 7/8 - 12	2.20	2.39	1 7/8	3.0	2.5	2.0
24 C50X	1 1/2	1 7/8 - 12	2.33	2.39	1 7/8	3.0	2.0	1.5
24-20 C50X	1 1/2	1 5/8 - 12	2.33	2.39	1 7/8	3.0	2.0	1.5
32 C50X	2	2 1/2 - 12	3.06	2.89	2 1/2	2.0	1.5	1.3
32-24 C50X	2	1 7/8 - 12	3.06	2.89	2 1/2	2.0	1.5	1.3

Dimensions and pressures for reference only, subject to change.

CTX

Male Elbow
37° Flare / NPTF

SAE 070202
HPD Base # 2103

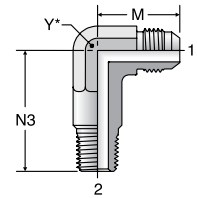


Y* – Across wrench flats

CCTX

Long Male Elbow
37° Flare / NPTF

SAE 071502
HPD Base # 5603



Y* – Across wrench flats

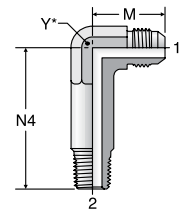
TUBE FITTING PART #	END SIZE		M (in.)	N (in.)	Y (in.)	Dynamic Pressure (x 1,000 PSI)		
	1 (in.)	2 NPTF				-S	-SS	-B
	2 CTX	1/8						
3 CTX	3/16	1/8 - 27	0.83	0.72	3/8	6.0	6.0	3.3
4 CTX	1/4	1/8 - 27	0.89	0.78	7/16	6.0	6.0	3.3
4-4 CTX	1/4	1/4 - 18	1.05	1.09	9/16	6.0	6.0	3.3
4-6 CTX	1/4	3/8 - 18	1.12	1.22	3/4	6.0	6.0	3.3
4-8 CTX	1/4	1/2 - 14	1.21	1.47	7/8	6.0	6.0	3.3
5 CTX	5/16	1/8 - 27	0.95	0.78	9/16	6.0	6.0	3.3
5-4 CTX	5/16	1/4 - 18	1.05	1.09	9/16	6.0	6.0	3.3
5-6 CTX	5/16	3/8 - 18	1.12	1.22	3/4	6.0	6.0	3.3
6 CTX	3/8	1/4 - 18	1.06	1.09	9/16	6.0	6.0	3.3
6-2 CTX	3/8	1/8 - 27	1.06	0.90	9/16	6.0	6.0	3.3
6-6 CTX	3/8	3/8 - 18	1.14	1.22	3/4	6.0	6.0	3.3
6-8 CTX	3/8	1/2 - 14	1.22	1.47	7/8	6.0	6.0	3.3
6-12 CTX	3/8	3/4 - 14	1.31	1.59	1 1/16	4.0	4.0	2.6
8 CTX	1/2	3/8 - 18	1.25	1.22	3/4	6.0	6.0	3.3
8-4 CTX	1/2	1/4 - 18	1.25	1.22	3/4	6.0	6.0	3.3
8-8 CTX	1/2	1/2 - 14	1.33	1.47	7/8	6.0	6.0	3.3
8-12 CTX	1/2	3/4 - 14	1.42	1.59	1 1/16	4.0	4.0	2.6
8-16 CTX	1/2	1 - 11 1/2	1.52	1.97	1 5/16	3.0	3.0	2.0
10 CTX	5/8	1/2 - 14	1.45	1.47	7/8	5.0	5.0	3.3
10-6 CTX	5/8	3/8 - 18	1.45	1.28	7/8	5.0	5.0	3.3
10-12 CTX	5/8	3/4 - 14	1.53	1.59	1 1/16	4.0	4.0	2.6
10-16 CTX	5/8	1 - 11 1/2	1.64	1.97	1 5/16	3.0	3.0	2.0
12 CTX	3/4	3/4 - 14	1.66	1.59	1 1/16	4.0	4.0	2.6
12-6 CTX	3/4	3/8 - 18	1.66	1.40	1 1/16	5.0	5.0	3.3
12-8 CTX	3/4	1/2 - 14	1.66	1.59	1 1/16	5.0	5.0	2.9
12-16 CTX	3/4	1 - 11 1/2	1.76	1.97	1 5/16	3.0	3.0	2.0
14 CTX	7/8	3/4 - 14	1.80	1.69	1 5/16	4.0	4.0	2.3
16 CTX	1	1 - 11 1/2	1.81	1.97	1 5/16	3.0	3.0	2.0
16-8 CTX	1	1/2 - 14	1.81	1.66	1 5/16	4.0	4.0	2.3
16-12 CTX	1	3/4 - 14	1.81	1.78	1 5/16	4.0	4.0	2.3
16-20 CTX	1	1 1/4 - 11 1/2	2.01	2.38	1 5/8	2.5	2.5	1.6
20 CTX	1 1/4	1 1/4 - 11 1/2	2.06	2.38	1 5/8	2.5	2.5	1.6
20-16 CTX	1 1/4	1 - 11 1/2	2.06	2.06	1 5/8	3.0	3.0	2.0
20-24 CTX	1 1/4	1 1/2 - 11 1/2	2.21	2.64	1 7/8	2.5	2.5	1.6
24 CTX	1 1/2	1 1/2 - 11 1/2	2.33	2.64	1 7/8	2.5	2.5	1.6
24-20 CTX	1 1/2	1 1/4 - 11 1/2	2.33	2.25	1 7/8	2.5	2.5	1.6
24-32 CTX	1 1/2	2 - 11 1/2	2.81	3.00	2 1/2	2.0	2.0	1.3
32 CTX	2	2 - 11 1/2	3.06	3.00	2 1/2	2.0	2.0	1.3
32-24 CTX	2	1 1/2 - 11 1/2	3.06	2.97	2 1/2	2.0	2.0	1.3
40 CTX	2 1/2	2 1/2 - 8	2.86	3.57	3 1/4	1.0	1.0	0.6

TUBE FITTING PART #	END SIZE		M (in.)	N3 (in.)	Y (in.)	Dynamic Pressure (x 1,000 PSI)		
	1 (in.)	2 NPTF				-S	-SS	-B
	4 CCTX	1/4						
4-4 CCTX	1/4	1/4 - 18	1.05	1.58	9/16	6.0	6.0	3.3
5 CCTX	5/16	1/8 - 27	0.95	1.17	9/16	6.0	6.0	3.3
6 CCTX	3/8	1/4 - 18	1.06	1.58	9/16	6.0	6.0	3.3
6-6 CCTX	3/8	3/8 - 18	1.14	1.82	3/4	6.0	6.0	3.3
8 CCTX	1/2	3/8 - 18	1.25	1.82	3/4	6.0	6.0	3.3
8-8 CCTX	1/2	1/2 - 14	1.33	2.17	7/8	6.0	6.0	3.3
8-12 CCTX	1/2	3/4 - 14	1.42	2.44	1 1/16	4.0	4.0	2.6
10 CCTX	5/8	1/2 - 14	1.45	2.17	7/8	5.0	5.0	3.3
12 CCTX	3/4	3/4 - 14	1.66	2.44	1 1/16	4.0	4.0	2.6
14 CCTX	7/8	3/4 - 14	1.80	2.59	1 5/16	4.0	4.0	2.3
16 CCTX	1	1 - 11 1/2	1.81	3.01	1 5/16	3.0	3.0	2.0
20 CCTX	1 1/4	1 1/4 - 11 1/2	2.06	3.69	1 5/8	2.5	2.5	1.6

CCCTX

Extra Long Male Elbow
37° Flare / NPTF

SAE 071602
HPD Base # 5703



Y* – Across wrench flats

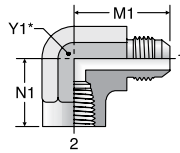
TUBE FITTING PART #	END SIZE		M (in.)	N4 (in.)	Y (in.)	Dynamic Pressure (x 1,000 PSI)		
	1 (in.)	2 NPTF				-S	-SS	-B
	4 CCCTX	1/4						
4-4 CCCTX	1/4	1/4 - 18	1.05	2.07	9/16	6.0	6.0	3.3
5 CCCTX	5/16	1/8 - 27	0.97	1.63	9/16	6.0	6.0	3.3
6 CCCTX	3/8	1/4 - 18	1.06	2.07	9/16	6.0	6.0	3.3
6-6 CCCTX	3/8	3/8 - 18	1.14	2.34	3/4	6.0	6.0	3.3
8 CCCTX	1/2	3/8 - 18	1.25	2.34	3/4	6.0	6.0	3.3
8-8 CCCTX	1/2	1/2 - 14	1.33	2.87	7/8	6.0	6.0	3.3
10 CCCTX	5/8	1/2 - 14	1.45	2.87	7/8	5.0	5.0	3.3
12 CCCTX	3/4	3/4 - 14	1.66	3.28	1 1/16	4.0	4.0	2.3
16 CCCTX	1	1 - 11 1/2	1.81	4.05	1 5/16	3.0	3.0	2.0
20 CCCTX	1 1/4	1 1/4 - 11 1/2	2.06	5.00	1 5/8	2.5	2.5	1.6

Dimensions and pressures for reference only, subject to change.

DTX

Female Elbow
37° Flare / NPTF

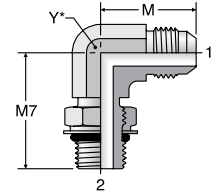
SAE 070203
HPD Base # 2203



Y* – Across wrench flats

C870MX

Male Elbow – ISO 6149
37° Flare / ISO 6149



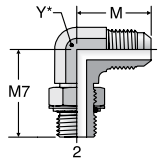
Y* – Across wrench flats

TUBE FITTING PART #	END SIZE		M1 (in.)	N1 (in.)	Y1 (in.)	Dynamic Pressure (x 1,000 PSI)		
	1 (in.)	2 NPTF				-S	-SS	-B
4 DTX	1/4	1/8 - 27	1.08	0.66	9/16	5.0	5.0	3.3
4-4 DTX	1/4	1/4 - 18	1.22	0.88	3/4	5.0	5.0	3.3
5 DTX	5/16	1/8 - 27	1.08	0.66	9/16	5.0	5.0	3.3
5-4 DTX	5/16	1/4 - 18	1.22	0.88	3/4	5.0	5.0	3.3
6 DTX	3/8	1/4 - 18	1.23	0.88	3/4	5.0	5.0	3.3
6-2 DTX	3/8	1/8 - 27	1.23	0.67	9/16	5.0	5.0	3.3
6-6 DTX	3/8	3/8 - 18	1.31	1.02	7/8	4.5	4.5	2.9
8 DTX	1/2	3/8 - 18	1.42	1.02	7/8	4.5	4.5	2.9
8-4 DTX	1/2	1/4 - 18	1.42	1.01	3/4	4.5	4.5	2.9
8-8 DTX	1/2	1/2 - 14	1.52	1.23	1 1/16	3.0	3.0	2.0
10 DTX	5/8	1/2 - 14	1.64	1.23	1 1/16	3.0	3.0	2.0
12 DTX	3/4	3/4 - 14	1.89	1.36	1 5/16	3.0	3.0	2.0
12-8 DTX	3/4	1/2 - 14	1.89	1.35	1 1/16	3.0	3.0	2.0
14 DTX	7/8	3/4 - 14	1.86	1.42	1 5/16	3.0	3.0	2.0
16 DTX	1	1 - 11 1/2	2.17	1.62	1 5/8	1.8	1.8	1.2
20 DTX	1 1/4	1 1/4 - 11 1/2	2.33	1.70	1 7/8	1.5	1.5	1.0
24 DTX	1 1/2	1 1/2 - 11 1/2	2.89	2.08	2 1/2	1.5	1.5	1.0

TUBE FITTING PART #	END SIZE		Male Metric Parallel Thread	M (mm)	M7 (mm)	Y (mm)	Dynamic Pressure (x 1,000 PSI)		
	1 (mm)	2 (in.)					S	SS	B
4M10C870MX	6	1/4	M10x1	22.6	27.1	11	6.0	5.0	3.3
5M12C870MX	8	5/16	M12x1.5	24.1	30.5	13	6.0	5.0	3.3
6M14C870MX	10	3/8	M14x1.5	26.9	33.5	14	6.0	5.0	3.3
8M16C870MX	12	1/2	M16x1.5	31.8	38.0	19	5.0	5.0	3.3
8M18C870MX	12	1/2	M18x1.5	31.8	38.0	19	5.0	5.0	3.3
10M18C870MX	14, 15, 16	5/8	M18x1.5	36.8	41.5	22	5.0	5.0	3.3
10M22C870MX	14, 15, 16	5/8	M22x1.5	36.8	42.5	22	5.0	5.0	3.3
12M22C870MX	18, 20	3/4	M22x.15	42.2	45.0	27	5.0	5.0	3.3
12M27C870MX	18, 20	3/4	M27x2	42.2	51.0	27	5.0	5.0	3.3
16M33C870MX	25	1	M33x2	46.0	53.0	33	4.0	4.0	2.6

C80MX

Male Elbow – Metric-ORR
37° Flare / Metric-ORR



Y* – Across wrench flats

TUBE FITTING PART #	END SIZE		Male Metric Parallel Thread	M (mm)	M7 (mm)	Y (mm)	Dynamic Pressure (x 1,000 PSI)		
	1 (mm)	2 (in.)					S	SS	B
4M10C80MX	6	1/4	M10x1	22.6	27.1	11	3.6	3.6	2.3
5M12C80MX	8	5/16	M12x1.5	24.1	30.5	13	3.6	3.6	2.3
6M14C80MX	10	3/8	M14x1.5	26.9	33.5	14	3.6	3.6	2.3
8M16C80MX	12	1/2	M16x1.5	31.8	38.0	19	3.6	3.6	2.3
8M18C80MX	12	1/2	M18x1.5	31.8	38.0	19	3.6	3.6	2.3
10M18C80MX	14, 15, 16	5/8	M18x1.5	36.8	41.5	22	3.6	3.6	2.3
10M22C80MX	14, 15, 16	5/8	M22x1.5	36.8	42.5	22	3.6	3.6	2.3
12M22C80MX	18, 20	3/4	M22x.15	42.2	45.0	27	3.6	3.6	2.3
12M27C80MX	18, 20	3/4	M27x2.0	42.2	51.0	27	2.5	2.5	1.6
16M33C80MX	25	1	M33x2.0	46.0	53.0	33	2.0	2.0	1.3

Dimensions and pressures for reference only, subject to change.

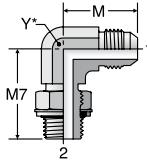
B

TABLE OF CONTENTS

VISUAL INDEX

C40MX

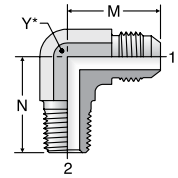
Male Elbow – BSPP
37° Flare / BSPP-ORR



Y* – Across wrench flats

C3MX

Male Elbow – BSPT
37° Flare / BSPT



Y* – Across wrench flats

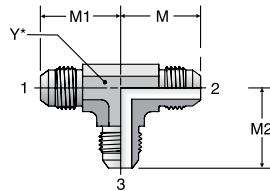
TUBE FITTING PART #	END SIZE			M (mm)	M7 (mm)	Y (mm)	Dynamic Pressure (x 1,000 PSI)		
	1		2				S	SS	B
	(mm)	(in.)	BSPP						
4C40MX	6	1/4	1/8-28	22.6	26.5	11	3.6	3.6	2.3
4-4C40MX	6	1/4	1/4-19	26.9	32.0	14	3.6	2.9	1.9
5C40MX	8	5/16	1/8-28	24.1	27.0	13	3.6	3.6	2.3
5-4C40MX	8	5/16	1/4-19	26.6	32.0	14	3.6	2.9	1.9
5-6C40MX	8	5/16	3/8-19	28.5	37.0	19	3.6	2.9	1.9
6C40MX	10	3/8	1/4-19	26.9	32.0	14	3.6	2.9	1.9
6-6C40MX	10	3/8	3/8-19	29.0	37.0	19	3.6	2.9	1.9
8-4C40MX	12	1/2	1/4-19	31.8	37.0	19	3.6	2.9	1.9
8C40MX	12	1/2	3/8-19	31.8	37.0	19	3.6	2.9	1.9
8-8C40MX	12	1/2	1/2-14	33.8	43.0	22	3.6	2.9	1.9
10-6C40MX	16	5/8	3/8-19	36.8	36.0	22	3.6	2.9	1.9
10C40MX	14,15,16	5/8	1/2-14	36.8	43.0	22	3.6	2.9	1.9
10-12C40MX	15	5/8	3/4-14	39.2	49.5	27	3.6	2.9	1.9
12-8C40MX	18,20	3/4	1/2-14	42.2	49.5	27	3.6	2.9	1.9
12C40MX	18,20	3/4	3/4-14	42.2	49.5	27	3.6	2.9	1.9
12-16C40MX	18	3/4	1-11	44.7	52.0	33	3.6	2.9	1.9
16-12C40MX	25	1	3/4-14	46.0	47.0	33	3.6	2.9	1.9
16C40MX	25	1	1-11	46.0	52.0	33	3.6	2.9	1.9
20-16C40MX	30,32	1 1/4	1-11	52.3	57.0	41	3.6	2.3	1.5
20C40MX	30,32	1 1/4	1 1/4-11	52.3	57.0	41	3.0	2.3	1.5
24-20C40MX	38	1 1/2	1 1/4-11	59.2	60.5	48	3.0	2.0	1.3
24C40MX	38	1 1/2	1 1/2-11	59.2	60.5	48	2.0	2.0	1.3

TUBE FITTING PART #	END SIZE			M (mm)	N (mm)	Y (mm)	Dynamic Pressure (x 1,000 PSI)		
	1		2				S	SS	B
	(mm)	(in.)	BSPT						
4C3MX	6	1/4	1/8 - 28	22.6	19.8	11	4.5	4.5	2.9
4-4C3MX	6	1/4	1/4 - 19	26.6	27.7	14	4.5	4.5	2.9
5C3MX	8	5/16	1/8 - 28	24.1	19.8	13	4.5	4.5	2.9
5-4C3MX	8	5/16	1/4 - 19	26.6	27.7	14	4.5	4.5	2.9
6C3MX	10	3/8	1/4 - 19	26.9	27.7	14	4.5	4.5	2.9
6-6C3MX	10	3/8	3/8 - 19	29.0	31.0	19	4.5	4.5	2.9
6-8C3MX	10	3/8	1/2 - 14	31.0	37.3	22	4.5	4.5	2.9
8-4C3MX	12	1/2	1/4 - 19	31.8	31.0	19	4.5	4.5	2.9
8C3MX	12	1/2	3/8 - 19	31.8	31.0	19	4.5	4.5	2.9
8-8C3MX	12	1/2	1/2 - 14	33.8	37.3	22	4.5	4.5	2.9
10-6C3MX	14,15,16	5/8	3/8 - 19	36.8	32.5	22	4.5	4.5	2.9
10C3MX	14,15,16	5/8	1/2 - 14	36.8	37.3	22	4.5	4.5	2.9
10-12C3MX	14,15,16	5/8	3/4 - 14	39.2	40.4	27	2.3	2.3	1.5
12-8C3MX	18,20	3/4	1/2 - 14	42.2	40.4	27	4.5	4.5	2.9
12C3MX	18,20	3/4	3/4 - 14	42.2	40.4	27	2.3	2.3	1.5
16-12C3MX	25	1	3/4 - 14	46.0	45.2	33	2.3	2.3	1.5
16C3MX	25	1	1 - 11	46.0	50.0	33	2.3	2.3	1.5
20-16C3MX	30,32	1 1/4	1 - 11	52.3	59.7	41	2.3	2.3	1.5
20C3MX	30,32	1 1/4	1 1/4 - 11	52.3	60.5	41	2.3	2.3	1.5
24C3MX	38	1 1/2	1 1/2 - 11	59.2	67.1	48	2.3	2.0	1.3

TABLE OF CONTENTS
VISUAL INDEX

JTX

Union Tee
37° Flare (all three ends)



Y* – Across wrench flats

SAE 070401
HPD Base # 033T

TUBE FITTING PART #	END SIZE			M (in.)	M1 (in.)	M2 (in.)	Y (in.)	Dynamic Pressure (x 1,000 PSI)		
	1	2	3					-S	-SS	-B
	(in.)	(in.)	(in.)							
2 JTX	1/8	1/8	1/8	0.77	0.77	0.77	5/16	7.5	7.7	3.3
3 JTX	3/16	3/16	3/16	0.83	0.83	0.83	7/16	7.5	7.7	3.3
4 JTX	1/4	1/4	1/4	0.89	0.89	0.89	7/16	7.5	7.7	3.3
4-4-3 JTX	1/4	1/4	3/16	0.89	0.89	0.81	7/16	7.5	7.7	3.3
5 JTX	5/16	5/16	5/16	0.95	0.95	0.95	9/16	6.0	6.0	3.3
6 JTX	3/8	3/8	3/8	1.06	1.06	1.06	9/16	6.0	6.0	3.3
8 JTX	1/2	1/2	1/2	1.25	1.25	1.25	3/4	6.0	6.0	3.3
10 JTX	5/8	5/8	5/8	1.45	1.45	1.45	7/8	5.0	5.0	3.3
12 JTX	3/4	3/4	3/4	1.66	1.66	1.66	1 1/16	5.0	5.0	2.9
12-12-8 JTX	3/4	3/4	1/2	1.66	1.66	1.42	1 1/16	5.0	5.0	2.9
12-16-12 JTX	3/4	1	3/4	1.77	1.81	1.77	1 5/16	4.0	3.5	2.3
14 JTX	7/8	7/8	7/8	1.80	1.80	1.80	1 5/16	5.0	5.0	2.9
16 JTX	1	1	1	1.81	1.81	1.81	1 5/16	4.0	3.5	2.3
20 JTX	1 1/4	1 1/4	1 1/4	2.06	2.06	2.06	1 5/8	4.0	3.0	2.0
24 JTX	1 1/2	1 1/2	1 1/2	2.33	2.33	2.33	1 7/8	3.0	2.0	1.5
24-16-16 JTX	1 1/2	1	1	2.33	2.16	2.16	1 7/8	3.0	2.0	1.5
32 JTX	2	2	2	3.06	3.06	3.06	2 1/2	2.0	1.5	1.0

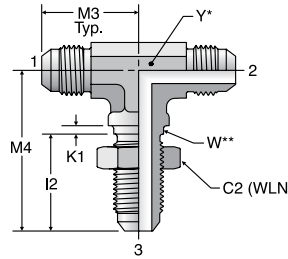
Dimensions and pressures for reference only, subject to change.



WJTX

Bulkhead Branch Tee
37° Flare (all three ends)

SAE 070959
HPD Base # 543T
WJTX-WLN – Body with locknut
(See page B10 for WLN)



Y* – Across wrench flats.
W** – Bulkhead pilot dia.
recommended clearance hole
+.015 over W dia.

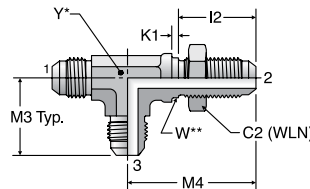
TUBE FITTING PART #	END SIZE (in.)	C2 HEX (in.)	I2 (in.)	K1 (in.)	M3 (in.)	M4 (in.)	W DIA (in.)	MAX BULKHEAD WALL THICKNESS (in.)	Y (in.)	Dynamic Pressure (x 1,000 PSI)		
										-S	-SS	-B
4 WJTX	1/4	11/16	1.02	0.09	0.97	1.59	0.44	0.25	7/16	7.5	7.7	3.3
6 WJTX	3/8	13/16	1.09	0.09	1.09	1.81	0.56	0.35	9/16	6.0	6.0	3.3
8 WJTX	1/2	1	1.25	0.13	1.36	2.11	0.75	0.35	3/4	6.0	6.0	3.3
10 WJTX	5/8	1 1/8	1.39	0.13	1.56	2.39	0.88	0.35	1 1/16	5.0	5.0	3.3
12 WJTX	3/4	1 3/8	1.56	0.13	1.78	2.67	1.06	0.35	1 1/16	5.0	5.0	2.9
16 WJTX	1	1 5/8	1.56	0.13	1.94	2.80	1.31	0.35	1 5/16	4.0	3.5	2.3
20 WJTX***	1 1/4	1 7/8	1.61	0.13	2.17	3.12	1.63	0.35	1 5/8	4.0	3.0	2.0

***Machined from one-piece milled bar stock.

WJJTX

Bulkhead Run Tee
37° Flare (all three ends)

SAE 070958
HPD Base # 533T
WJJTX-WLN – Body with locknut
(See page B10 for WLN)



Y* – Across wrench flats.
W** – Bulkhead pilot dia.
recommended clearance hole
+.015 over W dia.

TUBE FITTING PART #	END SIZE (in.)	C2 HEX (in.)	I2 (in.)	K1 (in.)	M3 (in.)	M4 (in.)	W DIA (in.)	MAX BULKHEAD WALL THICKNESS (in.)	Y (in.)	Dynamic Pressure (x 1,000 PSI)		
										-S	-SS	-B
4 WJJTX	1/4	11/16	1.02	0.09	0.97	1.59	0.44	0.25	7/16	7.5	7.7	3.3
6 WJJTX	3/8	13/16	1.09	0.09	1.09	1.81	0.56	0.35	9/16	6.0	6.0	3.3
8 WJJTX	1/2	1	1.25	0.13	1.36	2.11	0.75	0.35	3/4	6.0	6.0	3.3
10 WJJTX	5/8	1 1/8	1.39	0.13	1.56	2.39	0.88	0.35	7/8	5.0	5.0	3.3
12 WJJTX	3/4	1 3/8	1.56	0.13	1.78	2.67	1.06	0.35	1 1/16	5.0	5.0	2.9
16 WJJTX***	1	1 5/8	1.56	0.13	1.94	2.80	1.31	0.35	1 7/16	4.0	3.5	2.3
20 WJJTX***	1 1/4	1 7/8	1.61	0.13	2.17	3.12	1.63	0.35	1 5/8	4.0	3.0	2.0

***Machined from one-piece milled bar stock.

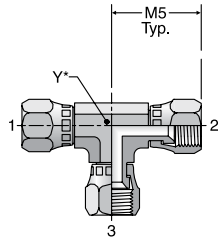
Dimensions and pressures for reference only, subject to change.



JX6

Swivel Nut Union Tee
37° Swivel (all three ends)

HPD Base # 069T



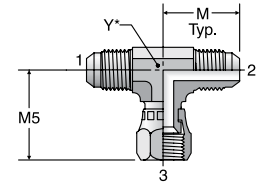
Y* – Across wrench flats

TUBE FITTING PART #	END SIZE			Dynamic Pressure (x 1,000 PSI)		
	1-3 (in.)	M5 (in.)	Y (in.)	-S	-SS	-B
				7.5	7.7	3.3
4 JX6	1/4	1.00	7/16	7.5	7.7	3.3
6 JX6	3/8	1.25	9/16	6.0	6.0	3.3
8 JX6	1/2	1.38	3/4	6.0	6.0	3.3
10 JX6	5/8	1.62	3/4	5.0	5.0	3.3
12 JX6	3/4	1.75	1 1/16	5.0	5.0	3.3
16 JX6	1	2.00	1 3/16	4.0	3.0	2.6

S6X

Swivel Nut Branch Tee
37° Flare / 37° Flare / 37° Swivel

SAE 070433
HPD Base # 393T



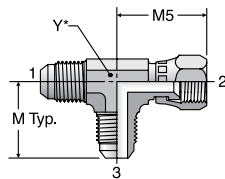
Y* – Across wrench flats

TUBE FITTING PART #	END SIZE				Dynamic Pressure (x 1,000 PSI)		
	1-3 (in.)	M (in.)	M5 (in.)	Y (in.)	-S	-SS	-B
					7.5	7.7	3.3
4 S6X	1/4	0.89	1.00	7/16	7.5	7.7	3.3
5 S6X	5/16	0.95	1.06	9/16	6.0	6.0	3.3
6 S6X	3/8	1.06	1.25	9/16	6.0	6.0	3.3
8 S6X	1/2	1.25	1.38	3/4	6.0	6.0	3.3
10 S6X	5/8	1.45	1.62	7/8	5.0	5.0	3.3
12 S6X	3/4	1.66	1.75	1 1/16	5.0	5.0	3.3
14 S6X	7/8	1.80	1.78	1 5/16	5.0	5.0	3.3
16 S6X	1	1.81	2.00	1 5/16	4.0	3.0	2.6
20 S6X	1 1/4	2.06	2.31	1 5/8	4.0	3.0	2.6
24 S6X	1 1/2	2.33	2.59	1 7/8	3.0	2.5	2.0

R6X

Swivel Nut Run Tee
37° Flare / 37° Swivel / 37° Flare

SAE 070432
HPD Base # 063T



Y* – Across wrench flats

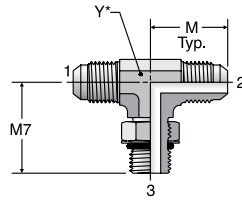
TUBE FITTING PART #	END SIZE				Dynamic Pressure (x 1,000 PSI)		
	1-3 (in.)	M (in.)	M5 (in.)	Y (in.)	-S	-SS	-B
					7.5	7.7	3.3
4 R6X	1/4	0.89	1.00	7/16	7.5	7.7	3.3
5 R6X	5/16	0.95	1.06	9/16	6.0	6.0	3.3
6 R6X	3/8	1.06	1.25	9/16	6.0	6.0	3.3
8 R6X	1/2	1.25	1.38	3/4	6.0	6.0	3.3
10 R6X	5/8	1.45	1.62	7/8	5.0	5.0	3.3
12 R6X	3/4	1.66	1.75	1 1/16	5.0	5.0	3.3
14 R6X	7/8	1.80	1.78	1 5/16	5.0	5.0	3.3
16 R6X	1	1.81	2.00	1 5/16	4.0	3.0	2.6
20 R6X	1 1/4	2.06	2.31	1 5/8	4.0	3.0	2.6
24 R6X	1 1/2	2.33	2.59	1 7/8	3.0	2.5	2.0

Dimensions and pressures for reference only, subject to change.

S50X

Straight Thread Branch Tee
37° Flare / 37° Flare /
SAE-ORB

SAE 070429
HPD Base # 253T



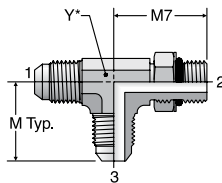
Y* – Across wrench flats

TUBE FITTING PART #	END SIZE			M (in.)	M7 (in.)	Y (in.)	Dynamic Pressure (x 1,000 PSI)		
	1 (in.)	2 (in.)	3 UN/UNF-2A (in.)				-S	-SS	-B
4 S50X	1/4	1/4	7/16 - 20	0.89	1.03	7/16	6.0	6.0	3.3
4-4-6 S50X	1/4	1/4	9/16 - 18	1.05	1.25	9/16	6.0	5.4	3.3
5 S50X	5/16	5/16	1/2 - 20	0.97	1.13	9/16	6.0	5.4	3.3
6 S50X	3/8	3/8	9/16 - 18	1.06	1.25	9/16	6.0	5.4	3.3
6-6-8 S50X	3/8	3/8	3/4 - 16	1.14	1.45	3/4	6.0	5.4	3.3
8 S50X	1/2	1/2	3/4 - 16	1.25	1.45	3/4	6.0	5.4	3.3
8-8-10 S50X	1/2	1/2	7/8 - 14	1.33	1.70	7/8	5.0	5.4	3.3
10 S50X	5/8	5/8	7/8 - 14	1.45	1.70	7/8	5.0	5.4	3.3
10-10-12 S50X	5/8	5/8	1 1/16 - 12	1.53	1.94	1 1/16	5.0	5.4	3.3
12 S50X	3/4	3/4	1 1/16 - 12	1.66	1.94	1 1/16	5.0	5.4	3.3
12-12-16 S50X	3/4	3/4	1 5/16 - 12	1.76	2.05	1 5/16	4.0	3.0	2.6
16 S50X	1	1	1 5/16 - 12	1.81	2.05	1 5/16	4.0	3.0	2.6
20 S50X	1 1/4	1 1/4	1 5/8 - 12	2.06	2.25	1 5/8	3.0	2.5	2.0
24 S50X	1 1/2	1 1/2	1 7/8 - 12	2.33	2.39	1 7/8	3.0	2.0	1.5
32 S50X	2	2	2 1/2 - 12	3.06	2.89	2 1/2	2.0	1.5	1.3

R50X

Straight Thread Run Tee
37° Flare / SAE-ORB /
37° Flare

SAE 070428
HPD Base # 053T



Y* – Across wrench flats

TUBE FITTING PART #	END SIZE			M (in.)	M7 (in.)	Y (in.)	Dynamic Pressure (x 1,000 PSI)		
	1 (in.)	2 UN/UNF-2A (in.)	3 (in.)				-S	-SS	-B
4 R50X	1/4	7/16 - 20	1/4	0.89	1.03	7/16	6.0	6.0	3.3
4-6-4 R50X	1/4	9/16 - 18	1/4	1.05	1.25	9/16	6.0	5.4	3.3
5 R50X	5/16	1/2 - 20	5/16	0.97	1.13	9/16	6.0	5.4	3.3
6 R50X	3/8	9/16 - 18	3/8	1.06	1.25	9/16	6.0	5.4	3.3
6-8-6 R50X	3/8	3/4 - 16	3/8	1.14	1.45	3/4	6.0	5.4	3.3
8 R50X	1/2	3/4 - 16	1/2	1.25	1.45	3/4	6.0	5.4	3.3
8-6-8 R50X	1/2	9/16 - 18	1/2	1.25	1.33	3/4	6.0	5.4	3.3
8-10-8 R50X	1/2	7/8 - 14	1/2	1.33	1.70	7/8	5.0	5.4	3.3
8-12-8 R50X	1/2	1 1/16 - 12	1/2	1.42	1.94	1 1/16	5.0	5.4	3.3
10 R50X	5/8	7/8 - 14	5/8	1.45	1.70	7/8	5.0	5.4	3.3
10-12-10 R50X	5/8	1 1/16 - 12	5/8	1.53	1.94	1 1/16	5.0	5.4	3.3
12 R50X	3/4	1 1/16 - 12	3/4	1.66	1.94	1 1/16	5.0	5.4	3.3
12-16-12 R50X	3/4	1 5/16 - 12	3/4	1.76	2.05	1 5/16	4.0	3.0	2.6
16 R50X	1	1 5/16 - 12	1	1.81	2.05	1 5/16	4.0	3.0	2.6
20 R50X	1 1/4	1 5/8 - 12	1 1/4	2.06	2.25	1 5/8	3.0	2.5	2.0
24 R50X	1 1/2	1 7/8 - 12	1 1/2	2.33	2.39	1 7/8	3.0	2.0	1.5
32 R50X	2	2 1/2 - 12	2	3.06	2.89	2 1/2	2.0	1.5	1.3

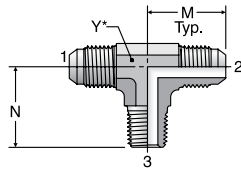
Dimensions and pressures for reference only, subject to change.



STX

Male Branch Tee
37° Flare / 37° Flare / NPTF

SAE 070425
HPD Base # 213T



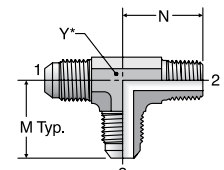
Y* – Across wrench flats

TUBE FITTING PART #	END SIZE		M (in.)	N (in.)	Y (in.)	Dynamic Pressure (x 1,000 PSI)		
	1 & 2 (in.)	3 NPTF				-S	-SS	-B
	3 STX	3/16						
4 STX	1/4	1/8 - 27	0.89	0.78	7/16	6.0	6.0	3.3
4-4-4 STX	1/4	1/4 - 18	1.05	1.09	9/16	6.0	6.0	3.3
4-4-6 STX	1/4	3/8 - 18	1.12	1.22	3/4	6.0	6.0	3.3
5 STX	5/16	1/8 - 27	0.95	0.78	9/16	6.0	6.0	3.3
5-5-4 STX	5/16	1/4 - 18	1.05	1.09	9/16	6.0	6.0	3.3
6 STX	3/8	1/4 - 18	1.06	1.09	9/16	6.0	6.0	3.3
6-6-6 STX	3/8	3/8 - 18	1.14	1.22	3/4	6.0	6.0	3.3
8 STX	1/2	3/8 - 18	1.25	1.22	3/4	6.0	6.0	3.3
8-8-8 STX	1/2	1/2 - 14	1.33	1.47	7/8	6.0	6.0	3.3
10 STX	5/8	1/2 - 14	1.45	1.47	7/8	5.0	5.0	3.3
12 STX	3/4	3/4 - 14	1.66	1.59	1 1/16	4.0	4.0	2.6
14 STX	7/8	3/4 - 14	1.80	1.69	1 5/16	4.0	4.0	2.3
16 STX	1	1 - 11 1/2	1.81	1.97	1 5/16	3.0	3.0	2.0
20 STX	1 1/4	1 1/4 - 11 1/2	2.06	2.38	1 5/8	2.5	2.5	1.6
24 STX	1 1/2	1 1/2 - 11 1/2	2.33	2.64	1 7/8	2.5	2.5	1.6

RTX

Male Run Tee
37° Flare / NPTF / 37° Flare

SAE 070424
HPD Base # 013T



Y* – Across wrench flats

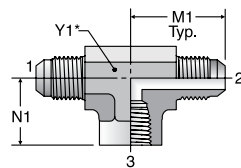
TUBE FITTING PART #	END SIZE		M (in.)	N (in.)	Y (in.)	Dynamic Pressure (x 1,000 PSI)		
	1 & 3 (in.)	2 NPTF				-S	-SS	-B
	3 RTX	3/16						
4 RTX	1/4	1/8 - 27	0.89	0.78	7/16	6.0	6.0	3.3
4-4-4 RTX	1/4	1/4 - 18	1.05	1.09	9/16	6.0	6.0	3.3
5 RTX	5/16	1/8 - 27	0.95	0.78	9/16	6.0	6.0	3.3
5-4-5 RTX	5/16	1/4 - 18	1.05	1.09	9/16	6.0	6.0	3.3
6 RTX	3/8	1/4 - 18	1.06	1.09	9/16	6.0	6.0	3.3
6-6-6 RTX	3/8	3/8 - 18	1.14	1.22	3/4	6.0	6.0	3.3
8 RTX	1/2	3/8 - 18	1.25	1.22	3/4	6.0	6.0	3.3
8-8-8 RTX	1/2	1/2 - 14	1.33	1.47	7/8	6.0	6.0	3.3
10 RTX	5/8	1/2 - 14	1.45	1.47	7/8	5.0	5.0	3.3
12 RTX	3/4	3/4 - 14	1.66	1.59	1 1/16	4.0	4.0	2.6
12-8-12 RTX	3/4	1/2 - 14	1.66	1.59	1 1/16	5.0	5.0	2.9
14 RTX	7/8	3/4 - 14	1.80	1.69	1 5/16	4.0	4.0	2.3
16 RTX	1	1 - 11 1/2	1.81	1.97	1 5/16	3.0	3.0	2.0
20 RTX	1 1/4	1 1/4 - 11 1/2	2.06	2.38	1 5/8	2.5	2.5	1.6
24 RTX	1 1/2	1 1/2 - 11 1/2	2.33	2.64	1 7/8	2.5	2.5	1.6

TABLE OF CONTENTS
VISUAL INDEX

OTX

Female Branch Tee
37° Flare / 37° Flare / NPTF

SAE 070427
HPD Base # 223T



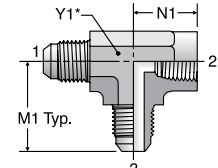
Y* – Across wrench flats

TUBE FITTING PART #	END SIZE		M1 (in.)	N1 (in.)	Y1 (in.)	Dynamic Pressure (x 1,000 PSI)		
	1 & 2 (in.)	3 NPTF				-S	-SS	-B
	4 OTX	1/4						
4-4-4 OTX	1/4	1/4 - 18	1.13	0.88	3/4	5.0	5.0	3.3
5 OTX	5/16	1/8 - 27	1.08	0.66	9/16	5.0	5.0	3.3
6 OTX	3/8	1/4 - 18	1.23	0.88	3/4	5.0	5.0	3.3
6-6-6 OTX	3/8	3/8 - 18	1.23	1.02	7/8	4.5	4.5	2.9
8 OTX	1/2	3/8 - 18	1.42	1.02	7/8	4.5	4.5	2.9
8-8-8 OTX	1/2	1/2 - 14	1.42	1.23	1 1/16	3.0	3.0	2.0
10 OTX	5/8	1/2 - 14	1.64	1.23	1 1/16	3.0	3.0	2.0
12 OTX	3/4	3/4 - 14	1.89	1.36	1 5/16	3.0	3.0	2.0
14 OTX	7/8	3/4 - 14	1.86	1.42	1 5/16	3.0	3.0	2.0
16 OTX	1	1 - 11 1/2	2.17	1.62	1 5/8	1.8	1.8	1.2
20 OTX	1 1/4	1 1/4 - 11 1/2	2.33	1.70	1 7/8	1.5	1.5	1.0
24 OTX	1 1/2	1 1/2 - 11 1/2	2.89	2.08	2 1/2	1.5	1.5	1.0

MTX

Female Run Tee
37° Flare / NPTF / 37° Flare

SAE 070426
HPD Base # 023T



Y* – Across wrench flats

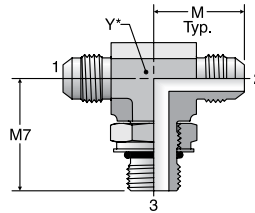
TUBE FITTING PART #	END SIZE		M1 (in.)	N1 (in.)	Y1 (in.)	Dynamic Pressure (x 1,000 PSI)		
	1 & 3 (in.)	2 NPTF				-S	-SS	-B
	4 MTX	1/4						
4-4-4 MTX	1/4	1/4 - 18	1.13	0.88	3/4	5.0	5.0	3.3
6 MTX	3/8	1/4 - 18	1.23	0.88	3/4	5.0	5.0	3.3
8 MTX	1/2	3/8 - 18	1.42	1.02	7/8	4.5	4.5	2.9
8-8-8 MTX	1/2	1/2 - 14	1.42	1.23	1 1/16	3.0	3.0	2.0
10 MTX	5/8	1/2 - 14	1.64	1.23	1 1/16	3.0	3.0	2.0
12 MTX	3/4	3/4 - 14	1.89	1.36	1 5/16	3.0	3.0	2.0
14 MTX	7/8	3/4 - 14	1.86	1.42	1 5/16	3.0	3.0	2.0
16 MTX	1	1 - 11 1/2	2.17	1.62	1 5/8	1.8	1.8	1.2
20 MTX	1 1/4	1 1/4 - 11 1/2	2.33	1.70	1 7/8	1.5	1.5	1.0
24 MTX	1 1/2	1 1/2 - 11 1/2	2.89	2.08	2 1/2	1.5	1.5	1.0

Dimensions and pressures for reference only, subject to change.



S870MX

ISO 6149 Branch Tee
37° Flare / 37° Flare / ISO 6149

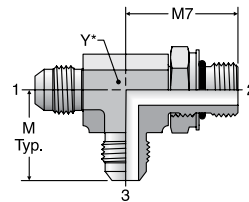


Y* – Across wrench flats

TUBE FITTING PART #	END SIZE			M (mm)	M7 (mm)	Y (mm)	Dynamic Pressure (x 1,000 PSI)		
	1 & 2		3				S	SS	B
	(mm)	(in.)	Male Metric Parallel Thread						
6M14S870MX	10	3/8	M14 x 1.5	26.9	33.5	14	6.0	6.0	3.3
8M16S870MX	12	1/2	M16 x 1.5	31.8	38.0	19	5.0	5.0	3.3
10M22S870MX	14,15,16	5/8	M22 x 1.5	36.8	42.5	22	5.0	5.0	3.3
12M27S870MX	18,20	3/4	M27 x 2	42.2	51.0	27	5.0	5.0	3.3

R870MX

ISO 6149 Run Tee
37° Flare / ISO 6149 / 37° Flare

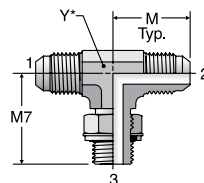


Y* – Across wrench flats

TUBE FITTING PART #	END SIZE			M (mm)	M7 (mm)	Y (mm)	Dynamic Pressure (x 1,000 PSI)		
	1 & 3		2				S	SS	B
	(mm)	(in.)	Male Metric Parallel Thread						
6M14R870MX	10	3/8	M14 x 1.5	26.9	33.5	14	6.0	6.0	3.3
8M16R870MX	12	1/2	M16 x 1.5	31.8	38.0	19	5.0	5.0	3.3
10M22R870MX	14,15,16	5/8	M22 x 1.5	36.8	42.5	22	5.0	5.0	3.3
12M27R870MX	18, 20	3/4	M27 x 1.5	42.2	51.0	27	5.0	5.0	3.3

S40MX

Male Branch Tee – BSPP
37° Flare / 37° Flare /
BSPP-ORR

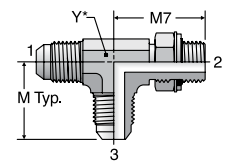


Y* – Across wrench flats

TUBE FITTING PART #	END SIZE			M (mm)	M7 (mm)	Y (mm)	Dynamic Pressure (x 1,000 PSI)		
	1 & 2		3				S	SS	B
	(mm)	(in.)	BSPP						
4S40MX	6	1/4	1/8 - 28	22.6	26.5	11	3.6	3.6	2.3
6S40MX	10	3/8	1/4 - 19	26.9	32.0	14	3.6	2.9	1.9
8S40MX	12	1/2	3/8 - 19	31.8	37.0	19	3.6	2.9	1.9
10S40MX	14,15,16	5/8	1/2 - 14	36.8	43.0	22	3.6	2.9	1.9
12S40MX	18,20	3/4	3/4 - 14	42.2	49.5	27	3.6	2.9	1.9
16S40MX	25	1	1 - 11	46.0	52.0	33	3.6	2.9	1.9

R40MX

Male Run Tee – BSPP
37° Flare / BSPP-ORR /
37° Flare



Y* – Across wrench flats

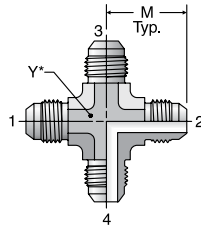
TUBE FITTING PART #	END SIZE			M (mm)	M7 (mm)	Y (mm)	Dynamic Pressure (x 1,000 PSI)		
	1 & 3		2				S	SS	B
	(mm)	(in.)	BSPP						
4R40MX	6	1/4	1/8 - 28	22.6	26.5	11	3.6	3.6	2.3
6R40MX	10	3/8	1/4 - 19	26.6	32.0	14	3.6	2.9	1.9
8R40MX	12	1/2	3/8 - 19	31.8	36.8	19	3.6	2.9	1.9
10R40MX	14,15,16	5/8	1/2 - 14	36.8	43.0	22	3.6	2.9	1.9
12R40MX	18,20	3/4	3/4 - 14	42.2	49.5	27	3.6	2.9	1.9
16R40MX	25	1	1 - 11	46.0	52.0	33	3.6	2.9	1.9
20R40MX	28, 30, 32	1 1/4	1 1/4 - 11	52.3	57.0	41	3.0	2.3	1.5

Dimensions and pressures for reference only, subject to change.

KTX

Union Cross
37° Flare (all four ends)

SAE 070501
HPD Base # 033X



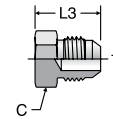
Y* – Across wrench flats

TUBE FITTING PART #	END SIZE	M (in.)	Y (in.)	Dynamic Pressure (x 1,000 PSI)		
				-S	-SS	-B
	1-4 (in.)					
4 KTX	1/4	0.89	7/16	7.5	7.7	3.3
5 KTX	5/16	0.95	9/16	6.0	6.0	3.3
6 KTX	3/8	1.06	9/16	6.0	6.0	3.3
8 KTX	1/2	1.25	3/4	6.0	6.0	3.3
10 KTX	5/8	1.45	7/8	5.0	5.0	3.3
12 KTX	3/4	1.66	1 1/16	5.0	5.0	2.9
16 KTX	1	1.81	1 5/16	4.0	3.5	2.3

PNTX

Plug
37° Flare

SAE 070109
HPD Base # 03CP



TUBE FITTING PART #	END SIZE	C HEX (in.)	L3 (in.)	Dynamic Pressure (x 1,000 PSI)		
				-S	-SS	-B
	1 (in.)					
2 PNTX	1/8	7/16	0.70	7.5	9	3.3
3 PNTX	3/16	7/16	0.73	7.5	9	3.3
4 PNTX	1/4	1/2	0.80	7.5	9	3.3
5 PNTX	5/16	9/16	0.80	6.0	7.2	3.3
6 PNTX	3/8	5/8	0.84	6.0	7.2	3.3
8 PNTX	1/2	13/16	0.94	6.0	7.2	3.3
10 PNTX	5/8	15/16	1.10	5.0	6.0	3.3
12 PNTX	3/4	1 1/8	1.28	5.0	6.0	3.3
14 PNTX	7/8	1 1/4	1.31	5.0	5.0	3.3
16 PNTX	1	1 3/8	1.33	4.5	5.4	2.9
20 PNTX	1 1/4	1 11/16	1.45	4.0	4.8	2.6
24 PNTX	1 1/2	2	1.65	4.0	4.8	2.6
32 PNTX	2	2 5/8	2.05	2.0	2.4	1.3

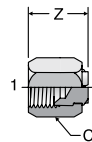
TABLE OF CONTENTS

VISUAL INDEX

FNTX

Cap
37° Flare

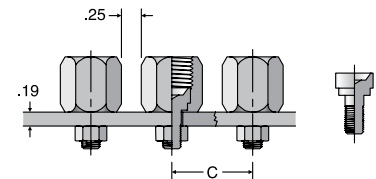
SAE 070112A
HPD Base # 06CP



TUBE FITTING PART #	END SIZE	C HEX (in.)	Z (in.)	Dynamic Pressure (x 1,000 PSI)		
				-S	-SS	-B
	1 (in.)					
2 FNTX	1/8	3/8	0.60	7.5	9.0	3.3
3 FNTX	3/16	7/16	0.66	7.5	9.0	3.3
4 FNTX	1/4	9/16	0.67	7.5	9.0	3.3
5 FNTX	5/16	5/8	0.77	6.0	7.2	3.3
6 FNTX	3/8	11/16	0.81	6.0	7.2	3.3
8 FNTX	1/2	7/8	0.94	6.0	7.2	3.3
10 FNTX	5/8	1	1.07	5.0	6.0	3.3
12 FNTX	3/4	1 1/4	1.24	5.0	6.0	3.3
14 FNTX	7/8	1 3/8	1.26	5.0	6.0	3.3
16 FNTX	1	1 1/2	1.29	4.5	5.4	2.9
20 FNTX	1 1/4	2	1.39	4.0	4.8	2.6
24 FNTX	1 1/2	2 1/4	1.70	3.0	3.6	2.0
32 FNTX	2	2 7/8	2.01	2.0	2.4	1.3

T22X

Mountie Cap

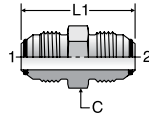


TUBE FITTING PART #	END SIZE		C (in.)	L (in.)	Dynamic Pressure (x 1,000 PSI)		
	1 (in.)	2 UNC/UNF-2A			-S	-SS	-B
	4 T22X	1/4	1/4 - 20	0.91	0.72	7.5	9.0
6 T22X	3/8	1/4 - 20	1.08	0.81	6.0	7.2	3.3
8 T22X	1/2	5/16 - 18	1.25	0.97	6.0	7.2	3.3

Dimensions and pressures for reference only, subject to change.

HTXO

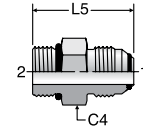
Union
37° Flare



TUBE FITTING PART #	END SIZE		C HEX (in.)	L1 (in.)	Dynamic Pressure (x 1,000 PSI) -SS
	1 & 2 (in.)				
4 HTXO	1/4		1/2	1.39	9.0
6 HTXO	3/8		5/8	1.42	7.7
8 HTXO	1/2		13/16	1.66	7.7
10 HTXO	5/8		15/16	1.98	6.0
12 HTXO	3/4		1 1/8	2.24	6.0
16 HTXO	1		1 3/8	2.41	5.4
20 HTXO	1 1/4		1 11/16	2.58	5.0
24 HTXO	1 1/2		2	2.90	5.0

F5OXO

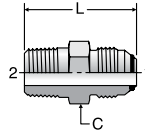
Straight Thread Connector
37° Flare / SAE-ORB



TUBE FITTING PART #	END SIZE		C4 HEX (in.)	L5 (in.)	Dynamic Pressure (x 1,000 PSI) -SS
	1 (in.)	2			
		UN/UNF-2A			
4 F5OXO	1/4	7/16 - 20	9/16	1.23	9.0
4-6 F5OXO	1/4	9/16 - 18	11/16	1.28	7.7
6 F5OXO	3/8	9/16 - 18	11/16	1.30	7.7
6-4 F5OXO	3/8	7/16 - 20	5/8	1.27	7.7
6-8 F5OXO	3/8	3/4 - 16	7/8	1.38	7.7
8 F5OXO	1/2	3/4 - 16	7/8	1.48	7.7
8-6 F5OXO	1/2	9/16 - 18	13/16	1.44	7.7
10 F5OXO	5/8	7/8 - 14	1	1.75	6.0
12 F5OXO	3/4	1 1/16 - 12	1 1/4	1.97	6.0
16 F5OXO	1	1 5/16 - 12	1 1/2	2.05	5.4
20 F5OXO	1 1/4	1 5/8 - 12	1 7/8	2.17	5.0
24 F5OXO	1 1/2	1 7/8 - 12	2 1/8	2.37	4.0
32 F5OXO	2	2 1/2 - 12	2 3/4	2.78	2.4

FTXO

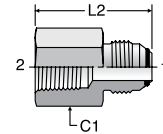
Male Connector
37° Flare / NPTF



TUBE FITTING PART #	END SIZE		C HEX (in.)	L (in.)	Dynamic Pressure (x 1,000 PSI) -SS
	1 (in.)	2 NPTF			
4 FTXO	1/4	1/8 - 27	1/2	1.23	6.0
4-4 FTXO	1/4	1/4 - 18	9/16	1.43	6.0
6 FTXO	3/8	1/4 - 18	5/8	1.45	6.0
6-6 FTXO	3/8	3/8 - 18	3/4	1.46	6.0
8 FTXO	1/2	3/8 - 18	13/16	1.53	6.0
8-8 FTXO	1/2	1/2 - 14	7/8	1.78	6.0
10 FTXO	5/8	1/2 - 14	15/16	1.94	5.0
12 FTXO	3/4	3/4 - 14	1 1/8	2.10	5.0
16 FTXO	1	1 - 11 1/2	1 3/8	2.38	4.5
20 FTXO	1 1/4	1 1/4 - 11 1/2	1 11/16	2.52	3.0
24 FTXO	1 1/2	1 1/2 - 11 1/2	2	2.76	3.0
32 FTXO	2	2 - 11 1/2	2 5/8	3.18	2.0

GTXO

Female Connector
37° Flare / NPTF

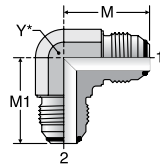


TUBE FITTING PART #	END SIZE		C1 HEX (in.)	L2 (in.)	Dynamic Pressure (x 1,000 PSI) -SS
	1 (in.)	2 NPTF			
4 GTXO	1/4	1/8 - 27	9/16	1.20	6.0
6 GTXO	3/8	1/4 - 18	3/4	1.41	6.0
8 GTXO	1/2	3/8 - 18	7/8	1.58	6.0
10 GTXO	5/8	1/2 - 14	1 1/8	1.94	5.0
12 GTXO	3/4	3/4 - 14	1 3/8	2.10	4.8
16 GTXO	1	1 - 11 1/2	1 5/8	2.43	3.6
20 GTXO	1 1/4	1 1/4 - 11 1/2	2	2.56	3.0
24 GTXO	1 1/2	1 1/2 - 11 1/2	2 3/8	2.70	2.4

Dimensions and pressures for reference only, subject to change.

ETXO

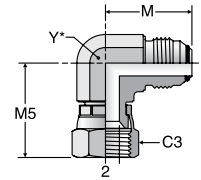
Union Elbow
37° Flare / 37° Flare



TUBE FITTING PART #	END SIZE (in.)	M (in.)	M1 (in.)	Y (in.)	Dynamic Pressure (x 1,000 PSI)
					-SS
4 ETXO	1/4	0.90	0.90	7/16	7.7
6 ETXO	3/8	1.08	1.08	9/16	6.0
8 ETXO	1/2	1.25	1.25	3/4	6.0
10 ETXO	5/8	1.50	1.50	7/8	5.0
12 ETXO	3/4	1.70	1.70	1 1/16	5.0
16 ETXO	1	1.89	1.89	1 5/16	5.0
20 ETXO	1 1/4	2.13	2.13	1 5/8	5.0
24 ETXO	1 1/2	2.33	2.33	1 7/8	5.0

C6XO

Swivel Nut Elbow
37° Flare / 37° Swivel



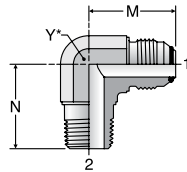
TUBE FITTING PART #	END SIZE (in.)	C3 HEX (in.)	M (in.)	M5 (in.)	M10 (in.)	Y (in.)	Dynamic Pressure (x 1,000 PSI)
							-SS
4 C6XO	1/4	9/16	0.90	1.00	0.66	7/16	7.7
6 C6XO	3/8	11/16	1.08	1.25	0.88	9/16	6.0
8 C6XO	1/2	7/8	1.25	1.38	0.95	3/4	6.0
10 C6XO	5/8	1	1.50	1.62	1.13	7/8	5.0
12 C6XO	3/4	1 1/4	1.70	1.75	1.19	1 1/16	5.0
16 C6XO	1	1 1/2	1.89	2.00	1.41	1 5/16	2.5
20 C6XO	1 1/4	2	2.13	2.31	1.69	1 5/8	2.5

TABLE OF CONTENTS

VISUAL INDEX

CTXO

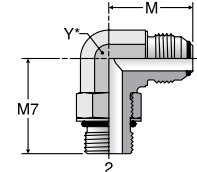
Male Elbow
37° Flare / NPTF



TUBE FITTING PART #	END SIZE		M (in.)	N (in.)	Y (in.)	Dynamic Pressure (x 1,000 PSI)
	1 (in.)	2 NPTF				-SS
4 CTXO	1/4	1/8 - 27	0.90	0.78	7/16	6.0
4-4 CTXO	1/4	1/4 - 18	1.06	1.09	9/16	6.0
6 CTXO	3/8	1/4 - 18	1.08	1.09	9/16	6.0
6-6 CTXO	3/8	3/8 - 18	1.16	1.22	3/4	6.0
8 CTXO	1/2	3/8 - 18	1.25	1.22	3/4	6.0
8-8 CTXO	1/2	1/2 - 14	1.33	1.47	7/8	6.0
10 CTXO	5/8	1/2 - 14	1.51	1.47	7/8	5.0
12 CTXO	3/4	3/4 - 14	1.70	1.59	1 1/16	4.0
16 CTXO	1	1 - 11 1/2	1.89	1.97	1 5/16	3.0
20 CTXO	1 1/4	1 1/4 - 11 1/2	2.13	2.38	1 5/8	2.5
24 CTXO	1 1/2	1 1/2 - 11 1/2	2.41	2.64	1 7/8	2.5
32 CTXO	2	2 - 11 1/2	3.13	3.00	2 1/2	2.0

C5OXO

Straight Thread Elbow
37° Flare / SAE-ORB

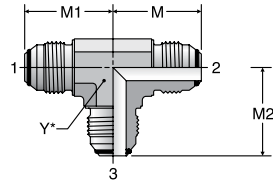


TUBE FITTING PART #	END SIZE		M (in.)	M7 (in.)	Y (in.)	Dynamic Pressure (x 1,000 PSI)
	1 (in.)	2 UN/UNF-2A				-SS
4 C5OXO	1/4	7/16 - 20	0.90	1.03	7/16	6.0
6 C5OXO	3/8	9/16 - 18	1.08	1.25	9/16	5.4
8 C5OXO	1/2	3/4 - 16	1.25	1.45	3/4	5.4
10 C5OXO	5/8	7/8 - 14	1.50	1.70	7/8	5.4
12 C5OXO	3/4	1 1/16 - 12	1.70	1.94	1 1/16	5.4
16 C5OXO	1	1 5/16 - 12	1.89	2.05	1 5/16	3.7
20 C5OXO	1 1/4	1 5/8 - 12	2.13	2.25	1 5/8	2.8
24 C5OXO	1 1/2	1 7/8 - 12	2.41	2.39	1 7/8	2.5
32 C5OXO	2	2 1/2 - 12	3.13	2.89	2 1/2	1.5

Dimensions and pressures for reference only, subject to change.

JTXO

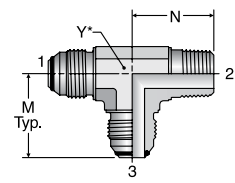
Union Tee
 37° Flare (all three ends)



TUBE FITTING PART #	END SIZE					Dynamic Pressure (x 1,000 PSI) -SS
	1 - 3 (in.)	M (in.)	M1 (in.)	M2 (in.)	Y (in.)	
4 JTXO	1/4	0.90	0.90	0.90	7/16	7.7
6 JTXO	3/8	1.08	1.08	1.08	9/16	6.0
8 JTXO	1/2	1.25	1.25	1.25	3/4	6.0
10 JTXO	5/8	1.50	1.50	1.50	7/8	5.0
12 JTXO	3/4	1.70	1.70	1.70	1 1/16	5.0
16 JTXO	1	1.89	1.89	1.89	1 5/16	5.0
20 JTXO	1 1/4	2.13	2.13	2.13	1 5/8	5.0
24 JTXO	1 1/2	2.41	2.41	2.41	1 7/8	5.0

RTXO

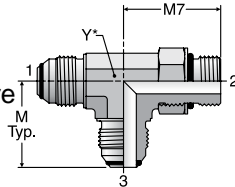
Male Run Tee
 37° Flare / NPTF / 37° Flare



TUBE FITTING PART #	END SIZE		M (in.)	N (in.)	Y (in.)	Dynamic Pressure (x 1,000 PSI) -SS
	1 & 3 (in.)	2 NPTF				
4 RTXO	1/4	1/8 - 27	0.90	0.78	7/16	6.0
6 RTXO	3/8	1/4 - 18	1.08	1.09	9/16	6.0
8 RTXO	1/2	3/8 - 18	1.25	1.22	3/4	6.0
10 RTXO	5/8	1/2 - 14	1.51	1.47	7/8	5.0
12 RTXO	3/4	3/4 - 14	1.70	1.59	1 1/16	4.0
16 RTXO	1	1 - 11 1/2	1.89	1.97	1 5/16	3.0
20 RTXO	1 1/4	1 1/4 - 11 1/2	2.13	2.38	1 5/8	2.5
24 RTXO	1 1/2	1 1/2 - 11 1/2	2.41	2.64	1 7/8	2.5

R5OXO

Straight Thread Run Tee
 37° Flare / SAE-ORB / 37° Flare



TUBE FITTING PART #	END SIZE		M (in.)	M7 (in.)	Y (in.)	Dynamic Pressure (x 1,000 PSI) -SS
	1 (in.)	2 UN/UNF-2A				
4 R5OXO	1/4	7/16 - 20	0.90	1.03	7/16	6.0
6 R5OXO	3/8	9/16 - 18	1.08	1.25	9/16	5.4
8 R5OXO	1/2	3/4 - 16	1.25	1.45	3/4	5.4
10 R5OXO	5/8	7/8 - 14	1.51	1.70	7/8	5.4
12 R5OXO	3/4	1 1/16 - 12	1.70	1.94	1 1/16	5.4
16 R5OXO	1	1 5/16 - 12	1.89	2.05	1 5/16	3.7
20 R5OXO	1 1/4	1 5/8 - 12	2.13	2.25	1 5/8	2.8

B

TABLE OF CONTENTS

VISUAL INDEX

Dimensions and pressures for reference only, subject to change.



TABLE
OF
CONTENTS

VISUAL
INDEX

Ferulok® Flareless Bite Type Fittings

C



ENGINEERING YOUR SUCCESS.







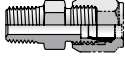
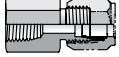
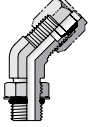

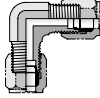
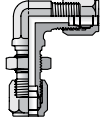
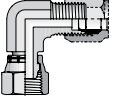
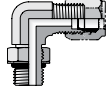
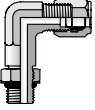
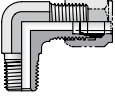
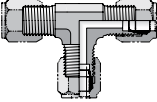
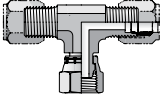
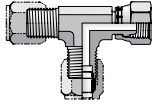
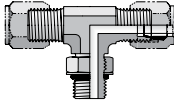
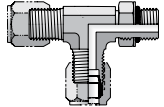
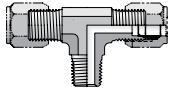
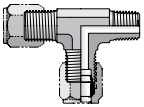
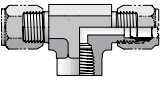
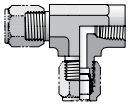



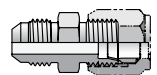
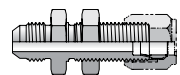
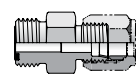
Nuts, Ferrules, Locknuts	BU Nut  C7	TU Ferrules  C7	WLN Bulkhead Locknut  C7	Straights	HBU Union  C7
	WBU Bulkhead Union  C8	F5BU SAE-ORB / Flareless  C8	FBU NPTF / Flareless  C8		GBU NPTF / Flareless  C9
45° Elbows	V5BU SAE-ORB / Flareless  C9	VBU NPTF / Flareless  C9	90° Elbows	EBU Union Elbow  C10	WEBU Bulkhead Union Elbow  C10
	C6BU Flareless Swivel/Flareless  C10	C5BU SAE-ORB / Flareless  C10		CC5BU SAE-ORB / Flareless  C11	CBU NPTF / Flareless  C11
Tees	JBU Union Tee  C12	S6BU Swivel Branch Tee  C12	R6BU Swivel Run Tee  C12	S5BU SAE-ORB Branch Tee  C12	R5BU SAE-ORB Run Tee  C13
	SBU NPTF Branch Tee  C13	RBU NPTF Run Tee  C13	OBU NPTF Branch Tee  C13	MBU NPTF Run Tee  C14	Cross
Plugs and Caps	PNU Plug  C14	FNU Cap  C14			

TABLE OF CONTENTS


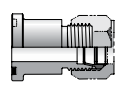

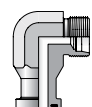
Dimensions and pressures for reference only, subject to change.

Conversion Adapters (Shown in Section K)


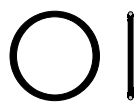
	XHBU 37° Flare / Flareless	XHBU2 37° / Flareless Bulkhead	BUHLO ORFS / 24° Flareless
			
	K4	K4	K4

C
TABLE OF CONTENTS

Flange Adapters (Shown in Section L)

	BUHQ1 Code 61 / Flareless	BUVQ1 Code 61 / Flareless	BUEQ1 Code 61 / Flareless
			
	L12	L30	L31

O-Rings and Seals (Shown in Section N)

	SAE O-Ring
	 N4

Dimensions and pressures for reference only, subject to change.

Introduction

The Ferulok fitting design and performance capabilities far exceed the strict requirements of SAE J514 and Military Standards (MIL-F-18866H). The Ferulok fitting is a flareless fitting that consists of a body, a one-piece ferrule, and a nut. On assembly, the ferrule “bites” into the outer surface of the tube with sufficient strength to hold the tube against pressure and seal the fluid, without considerable distortion of the inside tube diameter. Ferulok fittings have a visible bite, allowing the fitting assembler to visually inspect the bite quality, thus significantly minimizing the risk of improper assembly and related service problems. Ferulok fittings are especially suitable for use with tube wall thickness ranging from medium to extra heavy.

How Ferulok Fittings Work

The ferrule in the Ferulok fitting forms pressure tight seals with the tube and the fitting body. These seals are the result of several key characteristics graphically shown in Fig. C1. Below are detailed explanations of each of these key features.

- A. When properly assembled, the wedging action of the Ferulok design will cause the end of the tube to press firmly against the seat in the body. This action will cause the tube to develop a small indentation circumferentially on the bottom of the tube. This indentation serves as a good post assembly inspection criterion.
- B. As the ferrule moves forward, it contacts the tapered seat of the body, which causes the ferrule to cam inward into the tube. The leading edge of the hardened ferrule makes a clean 360° cut into the outside diameter of the tube. This cut is often termed a “bite” and thus “bite type fitting”. As the ferrule makes its bite, a small ridge of material is plowed up in front of the ferrule. This intimate contact of the tube ridge with the ferrule’s front face and bite edge gives the fitting its ability to retain high pressure without leaking or blowing off. A second seal point is also created between the now bowed ferrule and the fitting body seat.
- C. As the ferrule bites into the tube, the mid section will bow and the inside diameter of the back area firmly grips the tube. This action keeps the stresses, caused by flexural and vibration loading, from being concentrated in the bite area. The “compression grip” at the back end is a key factor for long life in rigorous applications.

All Ferulok parts come with the ferrule, and nut. However, Ferulok fittings can be purchased without nuts and sleeves for use with hose crimp fittings (Fig. C2). This can be done by dropping the ‘B’ from the part number. For example, (4 CBU-S, 4 CU-S). Sealing occurs between the 24° cone of the fitting body and the hose swivel as shown.

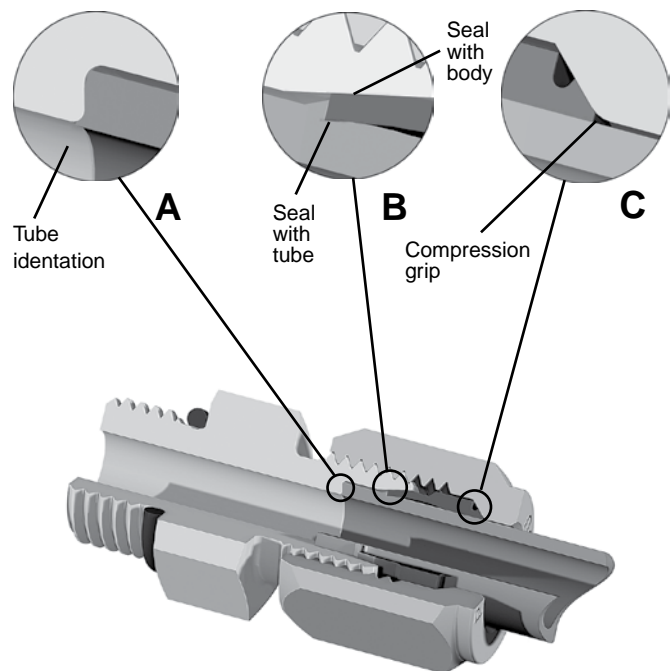


Fig. C1 – Assembled Ferulok Fitting with Tube

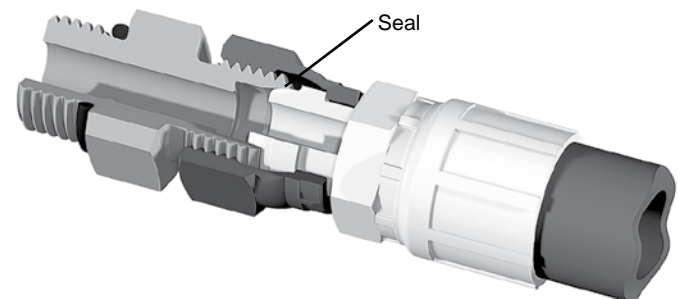


Fig. C2 – Ferulok Fitting with Hose Assembly

TABLE
OF
CONTENTS

VISUAL
INDEX

The Parker Advantage

Robust Port Stud: The adjustable port stud is manufactured with a longer locknut designed to cover the uppermost threads completely. Since the backup washer is never exposed to the upper threads, it cannot be damaged during assembly. During assembly, exposed upper threads, as common with fittings from other fitting manufacturers, can lead to a deformed backup washer that can pinch the o-ring and create an o-ring extrusion gap that has the potential to leak. The longer locknut also provides a greater grip area for the wrench.

Visible bite: The style A (SAE 08115A) ferrule design allows for an easy inspection of the bite in the tubing. A verification can quickly be achieved which reduces time and assures proper assembly. This assurance also eliminates the risk of leaks and catastrophic failures.

Rear compression grip: The ferrule is also designed with a rear bevel to firmly hold the nut and tubing. This enhancement dampens the effects of vibration in the connection; thus extending the life of the joint.

Metal-to-metal sealing: The metal to metal sealing function broadens the range of both temperatures and media types. The temperature and media range of Ferulok is not limited by an elastomeric seal, but by the range of steel and stainless steel (see page T9 of the General Technical section for material temperature and media compatibility).

Superior Plating: Superior plating gives Parker steel tube fittings unmatched protection against red rust. In neutral salt spray test per ASTM B117, Parker Ferulok fittings substantially exceeded the SAE requirement of 96 hours to red rest.

No special tooling required: Neither flaring nor flanging tools are required to make a Ferulok connection. Smaller sizes of Ferulok can be assembled by a wrench thus reducing tooling costs and assembly time. However, portable presetting equipment is available for larger sizes and/or high production (see Section R of the catalog for equipment available).

Reference locations

Standard Material Specifications: Refer to Table U1 in Appendix page U2.

Assembly and Installation: Please refer to Ferulok Assembly located within the Assembly/Installation section of this catalog.

Recommended Tube Wall Thickness: Please refer to Table U3 located in the Appendix section.

Dynamic Pressure Ratings: Please refer to the last column of the part number tables located on the following pages of this section for the appropriate dynamic pressure ratings.

Seal Material Selection: Please refer to Table T8 in the General Technical section of this catalog for elastomeric seal information.

Tube Recommendation

Maximum tube wall thickness is based on the pressure holding capability of Ferulok fittings. Tubes above the recommended range can be used. However, the pressure holding capability of the assembly will be limited to the fitting capacity. The proper Ferulok assembly procedures as outlined on pages S23 - S26 of this catalog are critical to the performance of the fitting. Steel Ferulok works best with seamless or welded and drawn fully annealed tube, SAE J356, SAE J524, SAE J525 (max. hardness, RB72) or equivalent specification steel tube. For stainless steel Ferulok fittings, types 304 and 316 of ASTM A269, ASTM A213 (max. hardness, RB90) or equivalent stainless steel tube is recommended.

Ferulok fittings are also suitable for use with soft metal tube and various types of plastic tubes such as nylon, polyethylene, etc. When used with plastic tube, it is strongly recommended that a tube insert, such as T23UI, be used to prevent tube pull out due to tensile loading.

See Table U3 in Appendix on Page U3. Consult the Parker Hannifin Tube Fittings Division for other combinations of tube and tube fitting materials not shown.

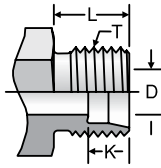
C

TABLE
OF
CONTENTS

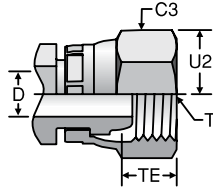
VISUAL
INDEX

Dimensions and pressures for reference only, subject to change.

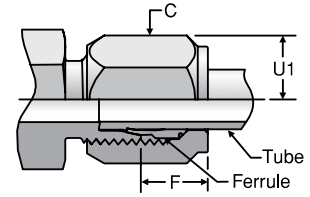
Ferulok Flareless Tube Ends



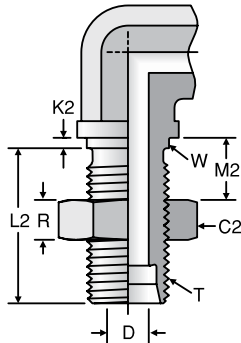
Ferulok Male Stud Tube End



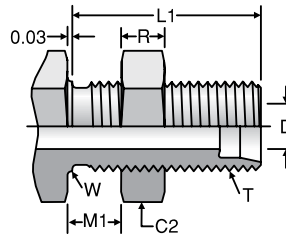
Ferulok Female Swivel End



Ferulok Tube End Assembly



Ferulok Shape Bulkhead



Ferulok Straight Bulkhead

TABLE OF CONTENTS

VISUAL INDEX

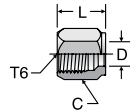
SAE Dash Size	Tube O.D. (in.)	T UN/UNF	C (in.)	C2 (in.)	C3 (in.)	D (in.)	Allowance		Male Turn Back	Bulkhead					Max Bulkhead Thickness		Thread Engagement	Across Corners	
							Tube Nut Assembled	Tube		Pilot Length Shapes	Length - Straights	Length - Shapes	Locknut Thickness	Pilot Dia	Straights	Shapes		Tube Nut Hex	Swivel Nut Hex
							F (in)	K (in)	L (in)	K2 (in)	L1 (in)	L2 (in)	R (in)	W ¹⁾ (in)	M1 (in)	M2 (in)	TE (in)	U1 (in)	U2 (in)
2	1/8	5/16-24	3/8	9/16	7/16	0.093	0.31	0.19	0.375	0.09	1.02	0.83	0.22	0.31	0.28	0.38	0.22	0.22	0.25
3	3/16	3/8-24	7/16	5/8	1/2	0.125	0.34	0.24	0.422	0.09	1.06	0.88	0.22	0.37	0.28	0.38	0.25	0.25	0.29
4	1/4	7/16-20	9/16	11/16	9/16	0.203	0.42	0.24	0.453	0.09	1.12	0.94	0.28	0.44	0.38	0.28	0.29	0.33	0.33
5	5/16	1/2-20	5/8	3/4	5/8	0.234	0.42	0.26	0.453	0.09	1.12	0.94	0.28	0.50	0.28	0.38	0.31	0.36	0.36
6	3/8	9/16-18	11/16	13/16	11/16	0.281	0.47	0.26	0.469	0.09	1.17	0.98	0.27	0.56	0.40	0.31	0.34	0.40	0.40
8	1/2	3/4-16	7/8	1	7/8	0.422	0.50	0.31	0.562	0.13	1.31	1.12	0.31	0.75	0.40	0.31	0.32	0.51	0.51
10	5/8	7/8-14	1	1 1/8	1	0.500	0.53	0.36	0.625	0.13	1.45	1.27	0.36	0.88	0.44	0.38	0.37	0.58	0.59
12	3/4	1 1/16-12	1 1/4	1 3/8	1 1/4	0.656	0.56	0.36	0.688	0.13	1.56	1.38	0.41	1.06	0.44	0.38	0.42	0.72	0.73
14	7/8	1 3/16-12	1 3/8	1 1/2	1 3/8	0.719	0.53	0.36	0.688	0.13	1.56	1.38	0.41	1.19	0.44	0.38	0.34	0.79	0.79
16	1	1 5/16-12	1 1/2	1 5/8	1 1/2	0.875	0.66	0.42	0.688	0.13	1.56	1.38	0.41	1.31	0.44	0.38	0.32	0.87	0.88
20	1 1/4	1 5/8-12	2	1 7/8	2	1.094	0.72	0.42	0.688	0.13	1.56	1.38	0.41	1.62	0.44	0.38	0.33	1.15	1.17
24	1 1/2	1 7/8-12	2 1/4	2 1/8	2 1/4	1.344	0.72	0.49	0.688	0.13	1.56	1.38	0.41	1.87	0.44	0.38	0.34	1.30	1.29
32	2	2 1/2-12	2 7/8	2 3/4	2 7/8	1.813	0.84	0.49	0.688	0.13	1.77	1.58	0.41	2.50	0.63	0.56	0.34	1.66	1.64

1) Recommended clearance hole +0.015 over W dia.
Note: For port and stud end dimensions reference Section F: Pipe Fittings and Port Adapters.

Dimensions and pressures for reference only, subject to change.



BU
Nut
Flareless

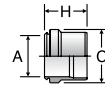


SAE 080110

TUBE FITTING PART #	TUBE O.D. (in.)	T6 UN/UNF-2B	C HEX (in.)	D DRILL (in.)	L (in.)	Material	
						-S	-SS
2 BU	1/8	5/16 - 24	3/8	0.130	0.53	•	•
3 BU	3/16	3/8 - 24	7/16	0.193	0.61	•	•
4 BU	1/4	7/16 - 20	9/16	0.255	0.70	•	•
5 BU	5/16	1/2 - 20	5/8	0.318	0.72	•	•
6 BU	3/8	9/16 - 18	11/16	0.380	0.75	•	•
8 BU	1/2	3/4 - 16	7/8	0.505	0.84	•	•
10 BU	5/8	7/8 - 14	1	0.631	0.92	•	•
12 BU	3/4	1 1/16 - 12	1 1/4	0.756	0.97	•	•
14 BU	7/8	1 3/16 - 12	1 3/8	0.881	1.00	•	•
16 BU	1	1 5/16 - 12	1 1/2	1.006	1.05	•	•
20 BU	1 1/4	1 5/8 - 12	2	1.260	1.05	•	•
24 BU	1 1/2	1 7/8 - 12	2 1/4	1.510	1.03	•	•
32 BU	2	2 1/2 - 12	2 7/8	2.014	1.12	•	•

Note: All stainless steel nuts are coated to prevent galling at assembly.

TU
Ferrule
Flareless

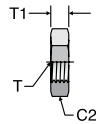


SAE 080115A

TUBE FITTING PART #	TUBE O.D. (in.)	A (in.)	C (in.)	H (in.)	Material	
					-S	-SS
2 TU	1/8	0.13	0.24	0.29	•	•
3 TU	3/16	0.19	0.31	0.33	•	•
4 TU	1/4	0.26	0.37	0.36	•	•
5 TU	5/16	0.32	0.43	0.37	•	•
6 TU	3/8	0.38	0.50	0.39	•	•
8 TU	1/2	0.51	0.66	0.43	•	•
10 TU	5/8	0.63	0.78	0.44	•	•
12 TU	3/4	0.76	0.93	0.48	•	•
14 TU	7/8	0.88	1.06	0.48	•	•
16 TU	1	1.01	1.19	0.48	•	•
20 TU	1 1/4	1.26	1.45	0.48	•	•
24 TU	1 1/2	1.51	1.69	0.48	•	•
32 TU	2	2.01	2.21	0.51	•	•

Steel TU sleeves are plated with a zinc phos.

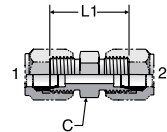
WLN
Bulkhead Locknut
Flareless



SAE 080118 and 070118

TUBE FITTING PART #	TUBE O.D. (in.)	T UN/UNF-2B	C2 HEX (in.)	T1 (in.)	Material	
					-S	-SS
3 WLN	3/16	3/8 - 24	5/8	0.22	•	•
4 WLN	1/4	7/16 - 20	11/16	0.28	•	•
5 WLN	5/16	1/2 - 20	3/4	0.28	•	•
6 WLN	3/8	9/16 - 18	13/16	0.27	•	•
8 WLN	1/2	3/4 - 16	1	0.31	•	•
10 WLN	5/8	7/8 - 14	1 1/8	0.36	•	•
12 WLN	3/4	1 1/16 - 12	1 3/8	0.41	•	•
14 WLN	7/8	1 3/16 - 12	1 1/2	0.41	•	•
16 WLN	1	1 5/16 - 12	1 5/8	0.41	•	•
20 WLN	1 1/4	1 5/8 - 12	1 7/8	0.41	•	•
24 WLN	1 1/2	1 7/8 - 12	2 1/8	0.41	•	•
32 WLN	2	2 1/2 - 12	2 3/4	0.41	•	•

HBU
Union
Flareless / Flareless



SAE 080101

TUBE FITTING PART #	END SIZE		C HEX (in.)	L1 (in.)	Dynamic Pressure (x 1,000 PSI)	
	1 (in.)	2 (in.)			-S	-SS
	2 HBU	1/8			1/8	7/16
3 HBU	3/16	3/16	7/16	1.11	6.0	6.0
4 HBU	1/4	1/4	1/2	1.19	6.0	6.0
5 HBU	5/16	5/16	9/16	1.19	6.0	6.0
6 HBU	3/8	3/8	5/8	1.24	6.0	6.0
6-4 HBU	3/8	1/4	5/8	1.22	6.0	6.0
8 HBU	1/2	1/2	13/16	1.42	5.0	5.0
8-6 HBU	1/2	3/8	13/16	1.33	5.0	5.0
10 HBU	5/8	5/8	15/16	1.61	5.0	5.0
10-8 HBU	5/8	1/2	15/16	1.55	5.0	5.0
12 HBU	3/4	3/4	1 1/8	1.81	4.5	4.5
14 HBU	7/8	7/8	1 1/4	1.81	4.0	4.0
16 HBU	1	1	1 3/8	1.81	4.0	4.0
20 HBU	1 1/4	1 1/4	1 11/16	1.89	3.0	3.0
24 HBU	1 1/2	1 1/2	2	1.96	2.0	2.0
32 HBU	2	2	2 5/8	2.11	1.5	1.5

Dimensions and pressures for reference only, subject to change.

C

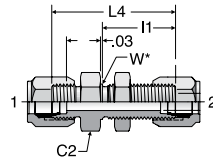
TABLE OF CONTENTS

VISUAL INDEX

WBU

Bulkhead Union
 Flareless / Flareless Bulkhead

SAE 080601



* W – Bulkhead pilot dia.
 recommended clearance
 hole is +.015 over W dia.

TUBE FITTING PART #	END SIZE		C2 HEX (in.)	I1 (in.)	L4 (in.)	W (in.)	Max. Bulkhead Thickness	Dynamic Pressure (x 1,000 PSI)	
	1 (in.)	2 (in.)						-S	-SS
4 WBU	1/4	1/4	11/16	1.12	1.89	0.44	0.38	6.0	6.0
6 WBU	3/8	3/8	13/16	1.17	1.98	0.56	0.40	6.0	6.0
8 WBU	1/2	1/2	1	1.31	2.22	0.75	0.40	5.0	5.0
10 WBU	5/8	5/8	1 1/8	1.45	2.48	0.88	0.44	5.0	5.0
12 WBU	3/4	3/4	1 3/8	1.56	2.72	1.06	0.44	4.5	4.5
16 WBU	1	1	1 5/8	1.56	2.72	1.31	0.44	4.0	4.0

Part comes with the WLN locknut.

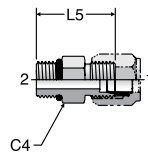
TABLE OF CONTENTS

VISUAL INDEX

F5BU

Straight Thread Connector
 Flareless / SAE-ORB

SAE 080120

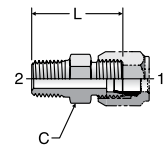


TUBE FITTING PART #	END SIZE		C4 HEX (in.)	L5 (in.)	Dynamic Pressure (x 1,000 PSI)	
	1 (in.)	2 UN/UNF-2A			-S	-SS
2 F5BU	1/8	5/16 - 24	7/16	0.99	6.0	6.0
3 F5BU	3/16	3/8 - 24	1/2	1.05	6.0	6.0
4 F5BU	1/4	7/16 - 20	9/16	1.13	6.0	6.0
4-5 F5BU	1/4	1/2 - 20	5/8	1.13	6.0	6.0
4-6 F5BU	1/4	9/16 - 18	11/16	1.20	6.0	6.0
5 F5BU	5/16	1/2 - 20	5/8	1.13	6.0	6.0
6 F5BU	3/8	9/16 - 18	11/16	1.22	6.0	6.0
6-4 F5BU	3/8	7/16 - 20	5/8	1.19	6.0	6.0
6-8 F5BU	3/8	3/4 - 16	7/8	1.28	6.0	6.0
8 F5BU	1/2	3/4 - 16	7/8	1.38	5.0	5.0
8-6 F5BU	1/2	9/16 - 18	13/16	1.28	5.0	5.0
8-10 F5BU	1/2	7/8 - 14	1	1.50	5.0	5.0
8-12 F5BU	1/2	1 1/16 - 12	1 1/4	1.67	4.5	4.5
10 F5BU	5/8	7/8 - 14	1	1.56	5.0	5.0
10-12 F5BU	5/8	1 1/16 - 12	1 1/4	1.73	4.5	4.5
12 F5BU	3/4	1 1/16 - 12	1 1/4	1.78	4.5	4.5
12-8 F5BU	3/4	3/4 - 16	1 1/8	1.75	4.5	4.5
12-16 F5BU	3/4	1 5/16 - 12	1 1/2	1.81	4.0	4.0
16 F5BU	1	1 5/16 - 12	1 1/2	1.81	4.0	4.0
16-12 F5BU	1	1 1/16 - 12	1 3/8	1.81	4.0	4.0
16-20 F5BU	1	1 5/8 - 12	1 7/8	1.91	3.0	3.0
20 F5BU	1 1/4	1 5/8 - 12	1 7/8	1.91	3.0	3.0
24 F5BU	1 1/2	1 7/8 - 12	2 1/8	1.97	3.0	3.0
32 F5BU	2	2 1/2 - 12	2 3/4	2.13	2.0	2.0

FBU

Male Connector
 Flareless / NPTF

SAE 080102



TUBE FITTING PART #	END SIZE		C HEX (in.)	L (in.)	Dynamic Pressure (x 1,000 PSI)	
	1 (in.)	2 NPTF			-S	-SS
2 FBU	1/8	1/8 - 27	7/16	1.04	6.0	6.0
2-4 FBU	1/8	1/4 - 18	9/16	1.24	6.0	6.0
3 FBU	3/16	1/8 - 27	7/16	1.09	6.0	6.0
4 FBU	1/4	1/8 - 27	1/2	1.12	6.0	6.0
4-4 FBU	1/4	1/4 - 18	9/16	1.32	6.0	6.0
4-6 FBU	1/4	3/8 - 18	3/4	1.33	6.0	6.0
4-8 FBU	1/4	1/2 - 14	7/8	1.58	6.0	6.0
5 FBU	5/16	1/8 - 27	9/16	1.12	6.0	6.0
5-4 FBU	5/16	1/4 - 18	9/16	1.32	6.0	6.0
6 FBU	3/8	1/4 - 18	5/8	1.34	6.0	6.0
6-2 FBU	3/8	1/8 - 27	5/8	1.15	6.0	6.0
6-6 FBU	3/8	3/8 - 18	3/4	1.35	6.0	6.0
6-8 FBU	3/8	1/2 - 14	15/16	1.60	6.0	6.0
8 FBU	1/2	3/8 - 18	13/16	1.44	5.0	5.0
8-4 FBU	1/2	1/4 - 18	13/16	1.44	5.0	5.0
8-8 FBU	1/2	1/2 - 14	7/8	1.69	5.0	5.0
8-12 FBU	1/2	3/4 - 14	1 1/8	1.76	4.0	4.0
10 FBU	5/8	1/2 - 14	15/16	1.75	4.5	4.5
10-6 FBU	5/8	3/8 - 18	15/16	1.56	4.5	4.5
10-12 FBU	5/8	3/4 - 14	1 1/8	1.82	4.0	4.0
12 FBU	3/4	3/4 - 14	1 1/8	1.88	4.0	4.0
12-8 FBU	3/4	1/2 - 14	1 1/8	1.88	4.0	4.0
14 FBU	7/8	3/4 - 14	1 1/4	1.88	3.0	3.0
16 FBU	1	1 - 11 1/2	1 3/8	2.07	3.0	3.0
16-12 FBU	1	3/4 - 14	1 3/8	1.88	3.0	3.0
20 FBU	1 1/4	1 1/4 - 11 1/2	1 11/16	2.18	2.5	2.5
24 FBU	1 1/2	1 1/2 - 11 1/2	2	2.28	2.5	2.5
32 FBU	2	2 - 11 1/2	2 3/4	2.46	2.0	2.0

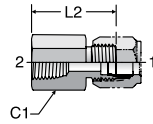
Dimensions and pressures for reference only, subject to change.



GBU

Female Connector
Flareless / NPTF

SAE 080103

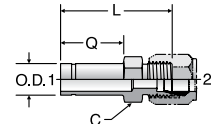


TUBE FITTING PART #	END SIZE		C1 HEX (in.)	L2 (in.)	Dynamic Pressure (x 1,000 PSI)	
	1 (in.)	2 NPTF			-S	-SS
	2 GBU	1/8			1/8 - 27	9/16
4 GBU	1/4	1/8 - 27	9/16	1.09	5.0	5.0
4-4 GBU	1/4	1/4 - 18	3/4	1.29	5.0	5.0
5 GBU	5/16	1/8 - 27	9/16	1.08	5.0	5.0
6 GBU	3/8	1/4 - 18	3/4	1.31	5.0	5.0
6-6 GBU	3/8	3/8 - 18	7/8	1.34	5.0	5.0
6-8 GBU	3/8	1/2 - 14	1 1/8	1.59	5.0	5.0
8 GBU	1/2	3/8 - 18	7/8	1.47	5.0	5.0
8-4 GBU	1/2	1/4 - 18	7/8	1.46	5.0	5.0
8-8 GBU	1/2	1/2 - 14	1 1/8	1.69	5.0	5.0
10 GBU	5/8	1/2 - 14	1 1/8	1.77	4.5	4.5
12 GBU	3/4	3/4 - 14	1 3/8	1.89	4.0	4.0
14 GBU	7/8	3/4 - 14	1 3/8	1.86	3.0	3.0
16 GBU	1	1 - 11 1/2	1 5/8	2.13	3.0	3.0
20 GBU	1 1/4	1 1/4 - 11 1/2	2	2.22	2.5	2.5
24 GBU	1 1/2	1 1/2 - 11 1/2	2 3/8	2.23	2.5	2.5

TRBU

Tube End Reducer
Tube / Flareless

SAE 080123



TUBE FITTING PART #	END SIZE		C HEX (in.)	L (in.)	Q (in.)	Dynamic Pressure (x 1,000 PSI)	
	1 (in.)	2 (in.)				-S	-SS
	6-4 TRBU	3/8				1/4	1/2
8-4 TRBU	1/2	1/4	9/16	1.73	1.00	5.0	5.0
8-6 TRBU	1/2	3/8	5/8	1.77	1.00	5.0	5.0
10-6 TRBU	5/8	3/8	11/16	1.86	1.09	5.0	5.0
10-8 TRBU	5/8	1/2	13/16	1.95	1.09	4.5	4.5
12-6 TRBU	3/4	3/8	13/16	1.94	1.16	4.5	4.5
12-8 TRBU	3/4	1/2	13/16	2.03	1.16	4.5	4.5
12-10 TRBU	3/4	5/8	15/16	2.16	1.16	4.5	4.5
14-10 TRBU	7/8	5/8	15/16	2.14	1.16	4.0	4.0
16-8 TRBU	1	1/2	1 1/16	2.05	1.13	4.0	4.0
16-10 TRBU	1	5/8	1 1/16	2.11	1.13	4.0	4.0
16-12 TRBU	1	3/4	1 1/8	2.25	1.13	4.0	4.0
20-16 TRBU	1 1/4	1	1 3/8	2.28	1.16	3.0	3.0
24-12 TRBU	1 1/2	3/4	1 5/8	2.45	1.25	2.0	2.0
24-16 TRBU	1 1/2	1	1 5/8	2.45	1.25	2.0	2.0
24-20 TRBU	1 1/2	1 1/4	1 7/8	2.45	1.25	2.0	2.0

C

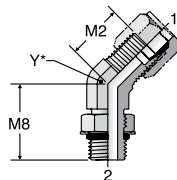
TABLE OF CONTENTS

VISUAL INDEX

V5BU

45° Straight Thread Elbow
Flareless / SAE-ORB

SAE 080320



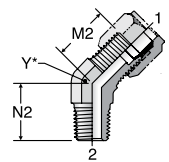
*Y – Across wrench flats

TUBE FITTING PART #	END SIZE		M2 (in.)	M8 (in.)	Y (in.)	Dynamic Pressure (x 1,000 PSI)	
	1 (in.)	2 UN/UNF-2A				-S	-SS
	4 V5BU	1/4				7/16 - 20	0.70
6 V5BU	3/8	9/16 - 18	0.83	1.14	9/16	5.0	5.0
8 V5BU	1/2	3/4 - 16	0.98	1.30	3/4	5.0	5.0
12 V5BU	3/4	1 1/16 - 12	1.27	1.73	1 1/16	4.0	4.0
16 V5BU	1	1 5/16 - 12	1.36	1.86	1 5/16	3.0	3.0

VBU

45° Male Elbow
Flareless / NPTF

SAE 080302



*Y – Across wrench flats

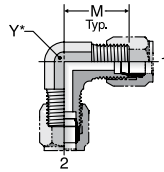
TUBE FITTING PART #	END SIZE		M2 (in.)	N2 (in.)	Y (in.)	Dynamic Pressure (x 1,000 PSI)	
	1 (in.)	2 NPTF				-S	-SS
	3 VBU	3/16				1/8 - 27	0.64
4 VBU	1/4	1/8 - 27	0.70	0.64	7/16	5.0	5.0
4-4 VBU	1/4	1/4 - 18	0.81	0.86	9/16	5.0	5.0
5 VBU	5/16	1/8 - 27	0.75	0.66	9/16	5.0	5.0
6 VBU	3/8	1/4 - 18	0.83	0.86	9/16	5.0	5.0
8 VBU	1/2	3/8 - 18	0.98	0.95	3/4	5.0	5.0
10 VBU	5/8	1/2 - 14	1.08	1.17	7/8	4.5	4.5
12 VBU	3/4	3/4 - 14	1.27	1.20	1 1/16	4.0	4.0
14 VBU	7/8	3/4 - 14	1.34	1.30	1 5/16	3.0	3.0
16 VBU	1	1 - 11 1/2	1.36	1.48	1 5/16	3.0	3.0
20 VBU	1 1/4	1 1/4 - 11 1/2	1.45	1.67	1 5/8	2.5	2.5

Dimensions and pressures for reference only, subject to change.

EBU

Union Elbow
Flareless / Flareless

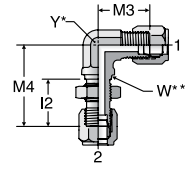
SAE 080201



* Y – Across wrench flats

WEBU

Bulkhead Union Elbow
Flareless / Flareless Bulkhead



* Y – Across wrench flats.
W** – Bulkhead pilot dia. recommended clearance hole is +.015 over W dia.

TUBE FITTING PART #	END SIZE		M (in.)	Y (in.)	Dynamic Pressure (x 1,000 PSI)	
	1 (in.)	2 (in.)			-S	-SS
	2 EBU	1/8				
4 EBU	1/4	1/4	0.89	7/16	5.0	5.0
5 EBU	5/16	5/16	0.95	9/16	5.0	5.0
6 EBU	3/8	3/8	1.05	9/16	5.0	5.0
8 EBU	1/2	1/2	1.25	3/4	5.0	5.0
10 EBU	5/8	5/8	1.42	7/8	4.5	4.5
12 EBU	3/4	3/4	1.58	1 1/16	4.0	4.0
14 EBU	7/8	7/8	1.66	1 5/16	3.0	3.0
16 EBU	1	1	1.73	1 5/16	3.0	3.0
20 EBU	1 1/4	1 1/4	1.89	1 5/8	2.5	2.5
24 EBU	1 1/2	1 1/2	2.02	1 7/8	2.0	2.0
32 EBU	2	2	2.45	2 1/2	1.5	1.5

TUBE FITTING PART #	END SIZE		I2 (in.)	M3 (in.)	M4 (in.)	W DIA (in.)	Y (in.)	Max. Bulkhead Thickness	Dynamic Pressure (x 1,000 PSI)	
	1 (in.)	2 (in.)							-S	-SS
	4 WEBU	1/4								
6 WEBU	3/8	3/8	0.98	1.08	1.70	0.56	9/16	0.26	5.0	5.0
8 WEBU	1/2	1/2	1.12	1.33	1.97	0.75	3/4	0.30	5.0	5.0
10 WEBU	5/8	5/8	1.27	1.52	2.27	0.88	7/8	0.38	4.5	4.5
12 WEBU	3/4	3/4	1.38	1.64	2.48	1.06	1 1/16	0.38	4.0	4.0
16 WEBU	1	1	1.38	1.73	2.61	1.31	1 5/16	0.38	3.0	3.0

Includes WLN locknut.

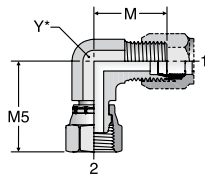
TABLE OF CONTENTS

VISUAL INDEX

C6BU

Swivel Nut Elbow
Flareless / Flareless Swivel

SAE 080221

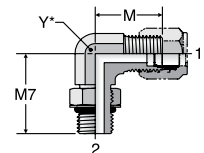


* Y – Across wrench flats

C5BU

Straight Thread Elbow
Flareless / SAE-ORB

SAE 080220



* Y – Across wrench flats

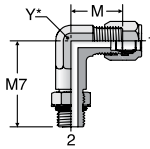
TUBE FITTING PART #	END SIZE		M (in.)	M5 (in.)	Y (in.)	Dynamic Pressure (x 1,000 PSI)	
	1 (in.)	2 (in.)				-S	-SS
	4 C6BU	1/4					
6 C6BU	3/8	3/8	1.05	1.25	9/16	5.0	5.0
8 C6BU	1/2	1/2	1.25	1.38	3/4	5.0	5.0
10 C6BU	5/8	5/8	1.42	1.62	7/8	4.5	4.5
12 C6BU	3/4	3/4	1.58	1.75	1 1/16	4.0	4.0
16 C6BU	1	1	1.73	2.00	1 5/16	3.0	3.0
20 C6BU	1 1/4	1 1/4	1.89	2.31	1 5/8	2.5	2.5

TUBE FITTING PART #	END SIZE		M (in.)	M7 (in.)	Y (in.)	Dynamic Pressure (x 1,000 PSI)	
	1 (in.)	2 UN/UNF-2A				-S	-SS
	3 C5BU	3/16					
4 C5BU	1/4	7/16 - 20	0.89	1.03	7/16	5.0	5.0
5 C5BU	5/16	1/2 - 20	0.95	1.13	9/16	5.0	5.0
6 C5BU	3/8	9/16 - 18	1.05	1.25	9/16	5.0	5.0
6-8 C5BU	3/8	3/4 - 16	1.14	1.45	3/4	5.0	5.0
8 C5BU	1/2	3/4 - 16	1.25	1.45	3/4	5.0	5.0
8-6 C5BU	1/2	9/16 - 18	1.27	1.33	3/4	5.0	5.0
8-10 C5BU	1/2	7/8 - 14	1.34	1.70	7/8	4.5	4.5
8-12 C5BU	1/2	1 1/16 - 12	1.43	1.94	1 1/16	4.0	4.0
10 C5BU	5/8	7/8 - 14	1.42	1.70	7/8	4.5	4.5
12 C5BU	3/4	1 1/16 - 12	1.58	1.94	1 1/16	4.0	4.0
12-8 C5BU	3/4	3/4 - 16	1.58	1.63	1 1/16	4.0	4.0
12-10 C5BU	3/4	7/8 - 14	1.58	1.78	1 1/16	4.0	4.0
12-16 C5BU	3/4	1 5/16 - 12	1.73	2.05	1 5/16	3.0	3.0
16 C5BU	1	1 5/16 - 12	1.73	2.05	1 5/16	3.0	3.0
16-12 C5BU	1	1 1/16 - 12	1.73	2.05	1 5/16	3.0	3.0
20 C5BU	1 1/4	1 5/8 - 12	1.89	2.25	1 5/8	2.5	2.5
24 C5BU	1 1/2	1 7/8 - 12	2.02	2.39	1 7/8	2.0	2.0
32 C5BU	2	2 1/2 - 12	2.45	2.89	2 1/2	1.5	1.5

Dimensions and pressures for reference only, subject to change.

CC5BU

Straight Thread Elbow
Flareless / SAE-ORB Long

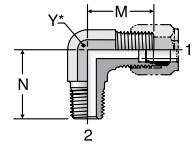


* Y – Across wrench flats

TUBE FITTING PART #	END SIZE		M (in.)	M7 (in.)	Y (in.)	Dynamic Pressure (x 1,000 PSI)	
	1 (in.)	2 UN/UNF-2A				-S	-SS
	4 CC5BU	1/4					
6 CC5BU	3/8	9/16 - 18	1.05	1.72	9/16	5.0	5.0
8 CC5BU	1/2	3/4 - 16	1.25	2.02	3/4	5.0	5.0
10 CC5BU	5/8	7/8 - 14	1.42	2.39	7/8	4.5	4.5
12 CC5BU	3/4	1 1/16 - 12	1.58	2.69	1 1/16	4.0	4.0
16 CC5BU	1	1 5/16 - 12	1.73	3.13	1 5/16	3.0	3.0

CBU

Male Elbow
Flareless / NPTF



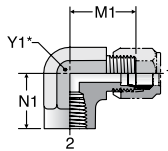
* Y – Across wrench flats

SAE 080202

TUBE FITTING PART #	END SIZE		M (in.)	N (in.)	Y (in.)	Dynamic Pressure (x 1,000 PSI)	
	1 (in.)	2 NPTF				-S	-SS
	2 CBU	1/8					
3 CBU	3/16	1/8 - 27	0.83	0.72	7/16	5.0	5.0
4 CBU	1/4	1/8 - 27	0.89	0.78	7/16	5.0	5.0
4-4 CBU	1/4	1/4 - 18	1.03	1.09	9/16	5.0	5.0
4-6 CBU	1/4	3/8 - 18	1.12	1.22	3/4	5.0	5.0
5 CBU	5/16	1/8 - 27	0.95	0.81	9/16	5.0	5.0
5-4 CBU	5/16	1/4 - 18	1.03	1.09	9/16	5.0	5.0
6 CBU	3/8	1/4 - 18	1.05	1.09	9/16	5.0	5.0
6-2 CBU	3/8	1/8 - 27	1.05	0.90	9/16	5.0	5.0
6-6 CBU	3/8	3/8 - 18	1.14	1.22	3/4	5.0	5.0
6-8 CBU	3/8	1/2 - 14	1.24	1.47	7/8	5.0	5.0
8 CBU	1/2	3/8 - 18	1.25	1.22	3/4	5.0	5.0
8-4 CBU	1/2	1/4 - 18	1.25	1.16	3/4	5.0	5.0
8-8 CBU	1/2	1/2 - 14	1.35	1.47	7/8	5.0	5.0
8-12 CBU	1/2	3/4 - 14	1.43	1.59	1 1/16	4.0	4.0
10 CBU	5/8	1/2 - 14	1.42	1.47	7/8	4.5	4.5
10-6 CBU	5/8	3/8 - 18	1.42	1.28	7/8	4.5	4.5
12 CBU	3/4	3/4 - 14	1.58	1.59	1 1/16	4.0	4.0
12-8 CBU	3/4	1/2 - 14	1.58	1.59	1 1/16	4.0	4.0
14 CBU	7/8	3/4 - 14	1.66	1.69	1 5/16	3.0	3.0
16 CBU	1	1 - 11 1/2	1.73	1.97	1 5/16	3.0	3.0
16-12 CBU	1	3/4 - 14	1.73	1.78	1 5/16	3.0	3.0
20 CBU	1 1/4	1 1/4 - 11 1/2	1.89	2.38	1 5/8	2.5	2.5
24 CBU	1 1/2	1 1/2 - 11 1/2	2.02	2.64	1 7/8	2.5	2.5
32 CBU	2	2 - 11 1/2	2.45	3.00	2 1/2	2.0	2.0

DBU

Female Elbow
Flareless / NPTF



* Y1 – Across wrench flats

SAE 080203

TUBE FITTING PART #	END SIZE		M1 (in.)	N1 (in.)	Y1 (in.)	Dynamic Pressure (x 1,000 PSI)	
	1 (in.)	2 NPTF				-S	-SS
	4 DBU	1/4					
4-4 DBU	1/4	1/4 - 18	1.03	0.88	3/4	5.0	5.0
5 DBU	5/16	1/8 - 27	0.95	0.66	9/16	5.0	5.0
6 DBU	3/8	1/4 - 18	1.05	0.88	3/4	5.0	5.0
6-6 DBU	3/8	3/8 - 18	1.13	1.02	7/8	4.5	4.5
8 DBU	1/2	3/8 - 18	1.23	1.02	7/8	3.0	3.0
8-4 DBU	1/2	1/4 - 18	1.23	0.88	3/4	5.0	5.0
8-8 DBU	1/2	1/2 - 14	1.34	1.23	1 1/16	3.0	3.0
10 DBU	5/8	1/2 - 14	1.42	1.23	1 1/16	3.0	3.0
12 DBU	3/4	3/4 - 14	1.58	1.36	1 5/16	3.0	3.0
14 DBU	7/8	3/4 - 14	1.62	1.42	1 5/16	3.0	3.0
16 DBU	1	1 - 11 1/2	1.73	1.63	1 5/8	1.7	1.7
20 DBU	1 1/4	1 1/4 - 11 1/2	2.08	1.70	1 7/8	1.5	1.5
24 DBU	1 1/2	1 1/2 - 11 1/2	2.58	2.08	2 1/2	1.0	1.0

C

TABLE OF CONTENTS

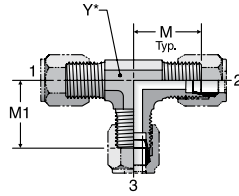
VISUAL INDEX

Dimensions and pressures for reference only, subject to change.

JBU

Union Tee
Flareless (all three ends)

SAE 080401



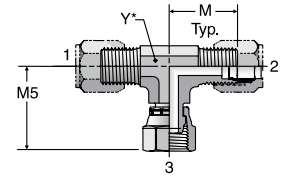
* Y – Across wrench flats

TUBE FITTING PART #	END SIZE			M (in.)	M1 (in.)	Y (in.)	Dynamic Pressure (x 1,000 PSI)	
	1 (in.)	2 (in.)	3 (in.)				-S	-SS
2 JBU	1/8	1/8	1/8	0.77	0.77	7/16	5.0	5.0
3 JBU	3/16	3/16	3/16	0.84	0.84	7/16	5.0	5.0
4 JBU	1/4	1/4	1/4	0.89	0.89	7/16	5.0	5.0
5 JBU	5/16	5/16	5/16	0.95	0.95	9/16	5.0	5.0
6 JBU	3/8	3/8	3/8	1.05	1.05	9/16	5.0	5.0
8 JBU	1/2	1/2	1/2	1.25	1.25	3/4	5.0	5.0
8-8-6 JBU	1/2	1/2	3/8	1.25	1.14	3/4	5.0	5.0
10 JBU	5/8	5/8	5/8	1.42	1.42	7/8	4.5	4.5
12 JBU	3/4	3/4	3/4	1.58	1.58	1 1/16	4.0	4.0
14 JBU	7/8	7/8	7/8	1.66	1.66	1 5/16	3.0	3.0
16 JBU	1	1	1	1.73	1.73	1 5/16	3.0	3.0
20 JBU	1 1/4	1 1/4	1 1/4	1.89	1.89	1 5/8	2.5	2.5
24 JBU	1 1/2	1 1/2	1 1/2	2.02	2.02	1 7/8	2.0	2.0

S6BU

Swivel Nut Branch Tee
Flareless / Flareless Swivel

SAE 080433



* Y – Across wrench flats

TUBE FITTING PART #	END SIZE			M (in.)	M5 (in.)	Y (in.)	Dynamic Pressure (x 1,000 PSI)	
	1 (in.)	2 (in.)	3 (in.)				-S	-SS
4 S6BU	1/4	1/4	1/4	0.89	1.00	7/16	5.0	5.0
6 S6BU	3/8	3/8	3/8	1.05	1.25	9/16	5.0	5.0
8 S6BU	1/2	1/2	1/2	1.25	1.38	3/4	5.0	5.0
12 S6BU	3/4	3/4	3/4	1.58	1.75	1 1/16	4.0	4.0
16 S6BU	1	1	1	1.73	2.00	15/16	3.0	3.0

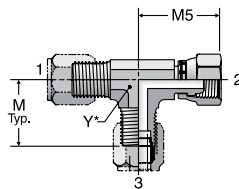
TABLE OF CONTENTS

VISUAL INDEX

R6BU

Swivel Nut Run Tee
Flareless / Flareless Swivel

SAE 080432



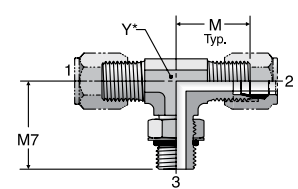
* Y – Across wrench flats

TUBE FITTING PART #	END SIZE			M (in.)	M5 (in.)	Y (in.)	Dynamic Pressure (x 1,000 PSI)	
	1 (in.)	2 (in.)	3 (in.)				-S	-SS
4 R6BU	1/4	1/4	1/4	0.89	1.00	7/16	5.0	5.0
6 R6BU	3/8	3/8	3/8	1.05	1.25	9/16	5.0	5.0
8 R6BU	1/2	1/2	1/2	1.25	1.38	3/4	5.0	5.0
12 R6BU	3/4	3/4	3/4	1.58	1.75	1 1/16	4.0	4.0
16 R6BU	1	1	1	1.73	2.00	1 5/16	3.0	3.0

S5BU

Straight Thread Branch Tee
Flareless / SAE-ORB

SAE 080429



* Y – Across wrench flats

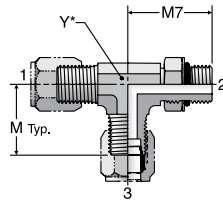
TUBE FITTING PART #	END SIZE			M (in.)	M7 (in.)	Y (in.)	Dynamic Pressure (x 1,000 PSI)	
	1 (in.)	2 (in.)	3 UN/UNF-2A				-S	-SS
4 S5BU	1/4	1/4	7/16 - 20	0.89	1.03	7/16	5.0	5.0
6 S5BU	3/8	3/8	9/16 - 18	1.05	1.25	9/16	5.0	5.0
8 S5BU	1/2	1/2	3/4 - 16	1.25	1.45	3/4	5.0	5.0
12 S5BU	3/4	3/4	1 1/16 - 12	1.58	1.94	1 1/16	4.0	4.0
16 S5BU	1	1	1 5/16 - 12	1.73	2.05	1 5/16	3.0	3.0

Dimensions and pressures for reference only, subject to change.

R5BU

Straight Thread Run Tee
 Flareless / SAE-ORB

SAE 080428



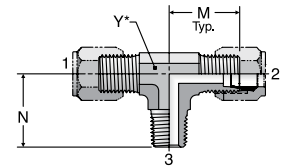
*Y – Across wrench flats

TUBE FITTING PART #	END SIZE			M (in.)	M7 (in.)	Y (in.)	Dynamic Pressure (x 1,000 PSI)	
	1 (in.)	2 UN/UNF-2A	3 (in.)				-S	-SS
	4 R5BU	1/4	7/16 - 20					
6 R5BU	3/8	9/16 - 18	3/8	1.05	1.25	9/16	5.0	5.0
8 R5BU	1/2	3/4 - 16	1/2	1.25	1.45	3/4	5.0	5.0
10 R5BU	5/8	7/8 - 14	5/8	1.42	1.70	7/8	4.5	4.5
12 R5BU	3/4	1 1/16 - 12	3/4	1.58	1.94	1 1/16	4.0	4.0
16 R5BU	1	1 5/16 - 12	1	1.73	2.05	1 5/16	3.0	3.0

SBU

Male Branch Tee
 Flareless / NPTF

SAE 080425



*Y – Across wrench flats

TUBE FITTING PART #	END SIZE			M (in.)	N (in.)	Y (in.)	Dynamic Pressure (x 1,000 PSI)	
	1 (in.)	2 (in.)	3 NPTF				-S	-SS
	2 SBU	1/8	1/8					
4 SBU	1/4	1/4	1/8 - 27	0.89	0.78	7/16	5.0	5.0
4-4-4 SBU	1/4	1/4	1/4 - 18	1.03	1.09	9/16	5.0	5.0
5 SBU	5/16	5/16	1/8 - 27	0.95	0.81	9/16	5.0	5.0
6 SBU	3/8	3/8	1/4 - 18	1.05	1.09	9/16	5.0	5.0
8 SBU	1/2	1/2	3/8 - 18	1.25	1.22	3/4	5.0	5.0
8-8-8 SBU	1/2	1/2	1/2 - 14	1.35	1.47	7/8	5.0	5.0
10 SBU	5/8	5/8	1/2 - 14	1.42	1.47	7/8	4.5	4.5
12 SBU	3/4	3/4	3/4 - 14	1.58	1.59	1 1/16	4.0	4.0
14 SBU	7/8	7/8	3/4 - 14	1.66	1.69	1 5/16	3.0	3.0
16 SBU	1	1	1 - 11 1/2	1.73	1.97	1 5/16	3.0	3.0

C

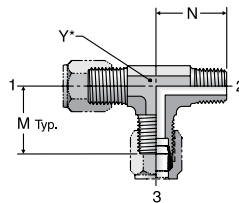
TABLE OF CONTENTS

VISUAL INDEX

RBU

Male Run Tee
 Flareless / NPTF

SAE 080424



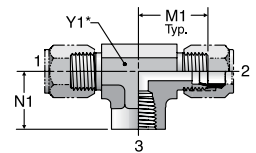
*Y – Across wrench flats

TUBE FITTING PART #	END SIZE			M (in.)	N (in.)	Y (in.)	Dynamic Pressure (x 1,000 PSI)	
	1 (in.)	2 NPTF	3 (in.)				-S	-SS
	4 RBU	1/4	1/8 - 27					
4-4-4 RBU	1/4	1/4 - 18	1/4	1.03	1.09	9/16	5.0	5.0
5 RBU	5/16	1/8 - 27	5/16	0.95	0.81	9/16	5.0	5.0
6 RBU	3/8	1/4 - 18	3/8	1.05	1.09	9/16	5.0	5.0
8 RBU	1/2	3/8 - 18	1/2	1.25	1.22	3/4	5.0	5.0
8-8-8 RBU	1/2	1/2 - 14	1/2	1.35	1.47	7/8	5.0	5.0
10 RBU	5/8	1/2 - 14	5/8	1.42	1.47	7/8	4.5	4.5
12 RBU	3/4	3/4 - 14	3/4	1.58	1.59	1 1/16	4.0	4.0
14 RBU	7/8	3/4 - 14	7/8	1.66	1.69	1 5/16	3.0	3.0
16 RBU	1	1 - 11 1/2	1	1.73	1.97	1 5/16	3.0	3.0

OBU

Female Branch Tee
 Flareless / NPTF

SAE 080427



*Y1 – Across wrench flats

TUBE FITTING PART #	END SIZE			M1 (in.)	N1 (in.)	Y1 (in.)	Dynamic Pressure (x 1,000 PSI)	
	1 (in.)	2 (in.)	3 NPTF				-S	-SS
	4 OBU	1/4	1/4					
4-4-4 OBU	1/4	1/4	1/4 - 18	1.03	0.88	3/4	5.0	5.0
6 OBU	3/8	3/8	1/4 - 18	1.05	0.88	3/4	5.0	5.0
8 OBU	1/2	1/2	3/8 - 18	1.23	1.02	7/8	3.0	3.0
10 OBU	5/8	5/8	1/2 - 14	1.42	1.23	1 1/16	3.0	3.0
12 OBU	3/4	3/4	3/4 - 14	1.58	1.36	1 5/16	3.0	3.0
14 OBU	7/8	7/8	3/4 - 14	1.62	1.42	1 5/16	3.0	3.0
16 OBU	1	1	1 - 11 1/2	1.73	1.63	1 5/8	1.7	1.7
20 OBU	1 1/4	1 1/4	1 1/4 - 11 1/2	2.08	1.70	1 7/8	1.5	1.5

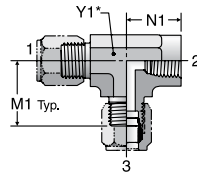
Dimensions and pressures for reference only, subject to change.



MBU

Female Run Tee
Flareless / NPTF

SAE 080426



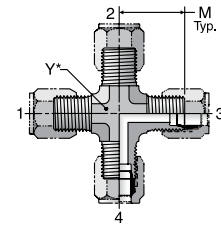
*Y1 – Across wrench flats

TUBE FITTING PART #	END SIZE			M1 (in.)	N1 (in.)	Y1 (in.)	Dynamic Pressure (x 1,000 PSI)	
	1 (in.)	2 NPTF	3 (in.)				-S	-SS
4 MBU	1/4	1/8 - 27	1/4	0.89	0.66	9/16	5.0	5.0
6 MBU	3/8	1/4 - 18	3/8	1.05	0.88	3/4	5.0	5.0
8 MBU	1/2	3/8 - 18	1/2	1.23	1.02	7/8	3.0	3.0
10 MBU	5/8	1/2 - 14	5/8	1.42	1.23	1 1/16	3.0	3.0
12 MBU	3/4	3/4 - 14	3/4	1.58	1.36	1 5/16	3.0	3.0
16 MBU	1	1 - 11 1/2	1	1.73	1.62	1 5/8	1.7	1.7

KBU

Union Cross
Flareless (all four ends)

SAE 080501



*Y – Across wrench flats

TUBE FITTING PART #	END SIZE 1-4 (in.)	M (in.)	Y (in.)	Dynamic Pressure (x 1,000 PSI)	
				-S	-SS
4 KBU	1/4	0.89	7/16	5.0	5.0
6 KBU	3/8	1.05	9/16	5.0	5.0
8 KBU	1/2	1.25	3/4	5.0	5.0
12 KBU	3/4	1.58	1 1/16	4.0	4.0

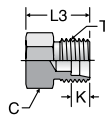
TABLE OF CONTENTS

VISUAL INDEX

PNU

Plug
Flareless

SAE 080109

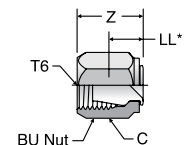


TUBE FITTING PART #	TUBE O.D. (in.)	T TUBE END UN/UNF-2A	C HEX (in.)	K (in.)	L3 (in.)	Dynamic Pressure (x 1,000 PSI)	
						-S	-SS
2 PNU	1/8	5/16 - 24	7/16	0.19	0.63	6.0	6.0
4 PNU	1/4	7/16 - 20	1/2	0.24	0.72	6.0	6.0
5 PNU	5/16	1/2 - 20	9/16	0.26	0.72	6.0	6.0
6 PNU	3/8	9/16 - 18	5/8	0.26	0.75	6.0	6.0
8 PNU	1/2	3/4 - 16	13/16	0.31	0.84	5.0	5.0
10 PNU	5/8	7/8 - 14	15/16	0.36	0.97	5.0	5.0
12 PNU	3/4	1 1/16 - 12	1 1/8	0.36	1.09	4.5	4.5
16 PNU	1	1 5/16 - 12	1 3/8	0.42	1.09	4.0	4.0

FNU

Cap
Flareless Swivel

SAE 080112



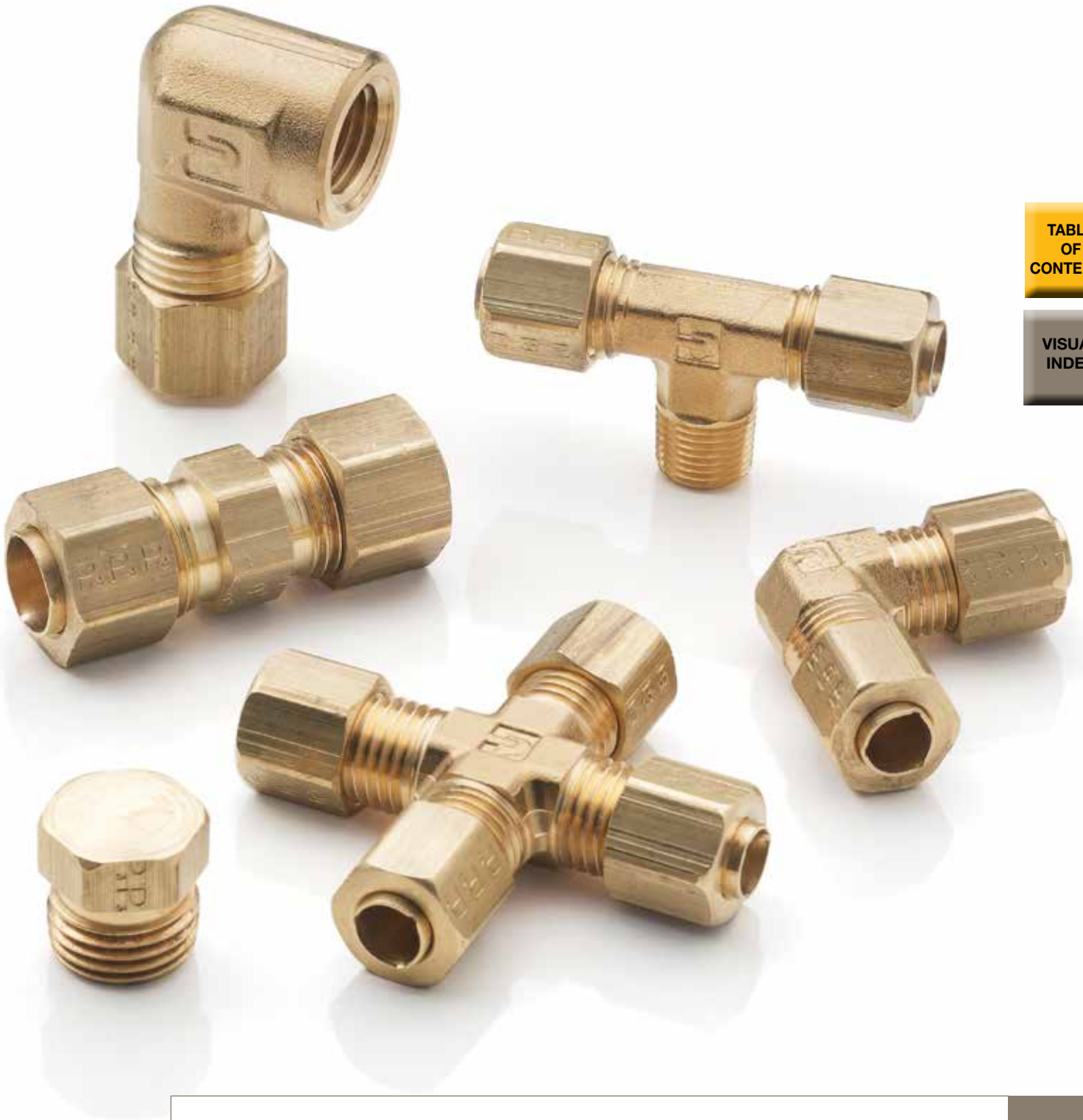
*LL – Fitting end to rear of plug

TUBE FITTING PART #	TUBE O.D. (in.)	T6 UN/UNF-2B	C HEX (in.)	LL (in.)	Z (in.)
2 FNU	1/8	5/16 - 24	3/8	0.34	0.55
4 FNU	1/4	7/16 - 20	9/16	0.36	0.73
5 FNU	5/16	1/2 - 20	5/8	0.40	0.77
6 FNU	3/8	9/16 - 18	11/16	0.42	0.80
8 FNU	1/2	3/4 - 16	7/8	0.44	0.87
10 FNU	5/8	7/8 - 14	1	0.47	0.98
12 FNU	3/4	1 1/16 - 12	1 1/4	0.48	1.00
16 FNU	1	1 5/16 - 12	1 1/2	0.58	1.08
20 FNU	1 1/4	1 5/8 - 12	2	0.64	1.11

Dimensions and pressures for reference only, subject to change.

TABLE
OF
CONTENTS

VISUAL
INDEX



Intru-lok® Flareless Bite Type Fittings

D



ENGINEERING YOUR SUCCESS.






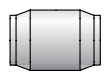
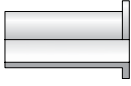

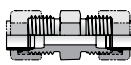

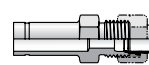

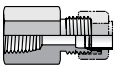

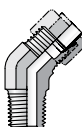

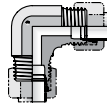
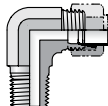
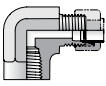

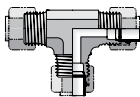
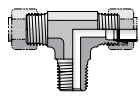
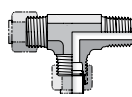
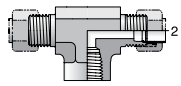
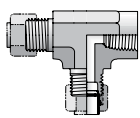
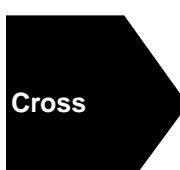
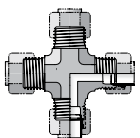



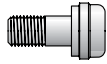
<p>Nuts, Ferrules, Inserts</p> 	<p>BIP Knurled Nut</p>  <p>D5</p>	<p>BI2 Nut</p>  <p>D5</p>	<p>BTI2 Nut and Ferrule</p>  <p>D5</p>	<p>TI2 Ferrule</p>  <p>D5</p>	<p>TIP Expander / Insert</p>  <p>D5</p>
<p>T23UI Insert</p>  <p>D5</p>	<p>Straights</p> 	<p>HB12 Union</p>  <p>D6</p>	<p>WB12 Bulkhead Union</p>  <p>D6</p>	<p>TRB12 Tube End Reducer</p>  <p>D6</p>	<p>FB12 NPTF / Intru-Lok</p>  <p>D6</p>
<p>GB12 NPTF / Intru-Lok</p>  <p>D6</p>	<p>45° Elbow</p> 	<p>VB12 NPTF / Intru-Lok</p>  <p>D6</p>	<p>90° Elbows</p> 	<p>EB12 Union Elbow</p>  <p>D7</p>	<p>CB12 NPTF / Intru-Lok</p>  <p>D7</p>
<p>DB12 NPTF / Intru-Lok</p>  <p>D7</p>	<p>Tees</p> 	<p>JB12 Union Tee</p>  <p>D7</p>	<p>SB12 NPTF Branch Tee</p>  <p>D7</p>	<p>RB12 NPTF Run Tee</p>  <p>D7</p>	<p>OB12 NPTF Branch Tee</p>  <p>D8</p>
<p>MB12 NPTF Run Tee</p>  <p>D8</p>	<p>Cross</p> 	<p>KB12 Union Cross</p>  <p>D8</p>	<p>Plugs and Caps</p> 	<p>PNI Plug</p>  <p>D8</p>	<p>FNI Cap</p>  <p>D8</p>
<p>T221 Mountie</p>  <p>B32</p>					

TABLE OF CONTENTS

Intru-Lok Flareless Bite Type Fittings

The Intru-Lok bite type fitting was developed by Parker Hannifin and introduced to the U.S. market in the late 1950's. This fitting addresses those applications that require a bite by the ferrule in brass, copper, aluminum and plastic tubing systems. The Intru-Lok fitting is a flareless fitting that consists of a body, a one-piece precision-machined ferrule, and a nut (Fig. D1). On assembly, the ferrule "bites" into the outer surface of the tube with sufficient strength to hold the tube against pressure. The ferrule also forms a pressure seal against the fitting body.

Intru-Lok fittings allow the fitting assembler to visually inspect the bite quality, thus significantly minimizing the risk of improper assembly and related service problems.

Intru-Lok fittings are routinely used in markets, such as: Machine tools, chemical, oil refineries, paper making, thermo-plastics processing, air and lube lines, pilot lines, panel boards, etc.

Design and Construction

The three components of Intru-Lok fittings are designed and manufactured to produce a reliable, leak free joint upon assembly. The ferrules are precision machined with all dimensions and surfaces, particularly the critical bite edge, monitored on an ongoing basis.

How Intru-Lok Fittings Work

In assembly, the ferrule is driven forward on the tube by the nut during pre-set. As the ferrule moves forward it contacts the tapered seat area of the body, which causes the ferrule to cam inward into the tube. The leading edge of the ferrule is thus able to make a clean 360 degree cut into the outside diameter of the tubing. This cut in the tubing is often referred to as a "Bite"; thus the term: **Bite Type Fitting**. As the ferrule makes its bite, a small ridge of tube material is raised up in front of the ferrule.

The Parker Advantage - Intru-Lok

Bite Type Connection: The Intru-Lok design includes a precision machined ferrule to assure a safe, leak-free, and vibration resistant connection compared to compression fittings. This provides a more reliable fitting where proper assembly can be verified by a visible bite by the ferrule into the tubing.

Ease of Assembly: Intru-Lok products include a ferrule and nut that do not need to be removed prior to insertion of the associated tubing for final assembly. Along with the low assembly torque require, the overall installation process is reduced, saving time and money.

Knurled Nut: In areas where wrench clearance are not available Parker offers an alternative knurled BIP nut. This nut can be tightened by hand allowing for quick assembly and disassembly without the use of tools.

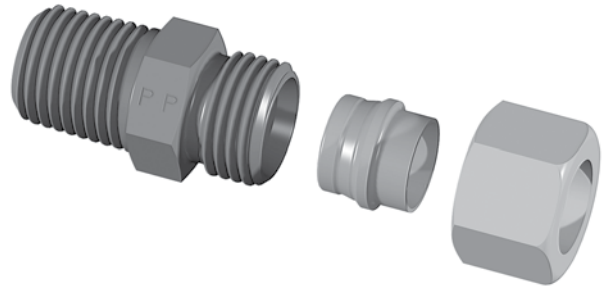


Fig. D1 – Intru-Lok Components: Body, Ferrule and Nut

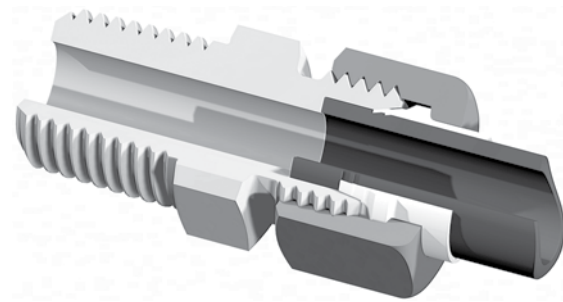


Fig. D2 – Assembled Intru-Lok Fitting

Reference locations

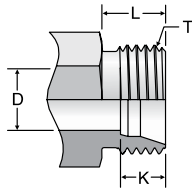
Dynamic Pressure Ratings: Please refer to the last column of the part number tables located on the following pages of this section for the appropriate dynamic pressure ratings.

Assembly and Installation: Please refer to Intru-Lok Assembly located within the Assembly/Installation section of this catalog.

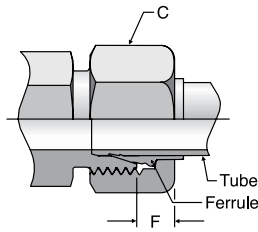
Standard material specifications: Please refer to Table U1 located in the Appendix section.

Dimensions and pressures for reference only, subject to change.

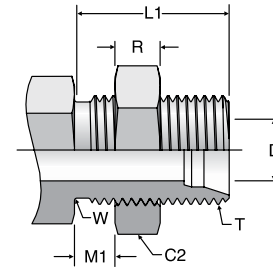
Intrulok Flareless Tube Ends



**Intrulok Male
 Stud Tube End**



**Intrulok Tube End
 Assembly**



**Intrulok Straight
 Bulkhead**

TABLE
 OF
 CONTENTS

VISUAL
 INDEX

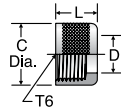
SAE Dash Size	Tube O.D. (in.)	T UN/UNF	C (in.)	C2 (in.)	D (in)	Allowance		Male Turn Back (in)	Bulkhead			Max Bulkhead Thickness (in)
						F (in)	K (in)		Length (in)	Locknut Thickness (in)	Pilot Dia (in)	
2	1/8	5/16-24	3/8	9/16	0.093	0.13	0.19	0.28	NA	NA	NA	NA
3	3/16	3/8-24	7/16	5/8	0.125	0.15	0.24	0.25	NA	NA	NA	NA
4	1/4	7/16-20	1/2	11/16	0.203	0.16	0.24	0.30	0.88	0.28	0.44	0.28
5	5/16	1/2-20	9/16	3/4	0.234	0.18	0.26	0.33	NA	NA	NA	NA
6	3/8	9/16-18	5/8	13/16	0.282	0.19	0.26	0.36	0.94	0.27	0.56	0.31
8	1/2	3/4-16	7/8	1	0.422	0.23	0.31	0.44	1.06	0.31	0.75	0.31

1) Recommended clearance hole +0.015 over W dia

Dimensions and pressures for reference only, subject to change.

BIP*

Knurled Nut
Intru-Lok

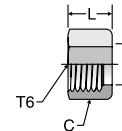


TUBE FITTING PART #	END SIZE (in.)	T6 TUBE END UN/UNF-2B	D2 DIA. (in.)	D (in.)	L (in.)
4 BIP	1/4	7/16 - 20	0.50	0.26	0.39
6 BIP	3/8	9/16 - 18	0.63	0.38	0.42

* For use with thermoplastic tube and TIP expander / insert.

BI2

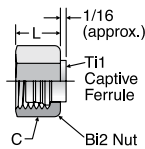
Nut
Intru-Lok



TUBE FITTING PART #	END SIZE (in.)	T6 TUBE END UN/UNF-2B	C HEX (in.)	D (in.)	L (in.)
2 BI2	1/8	5/16 - 24	3/8	0.17	0.36
3 BI2	3/16	3/8 - 24	7/16	0.23	0.34
4 BI2	1/4	7/16 - 20	1/2	0.30	0.44
5 BI2	5/16	1/2 - 20	9/16	0.36	0.45
6 BI2	3/8	9/16 - 18	5/8	0.42	0.45
8 BI2	1/2	3/4 - 16	7/8	0.56	0.58

BTI2

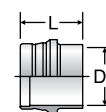
Nut and Ferrule
Intru-Lok



TUBE FITTING PART #	END SIZE (in.)	C HEX (in.)	L (in.)
2 BTI2	1/8	3/8	0.36
3 BTI2	3/16	7/16	0.34
4 BTI2	1/4	1/2	0.44
5 BTI2	5/16	9/16	0.45
6 BTI2	3/8	5/8	0.45
8 BTI2	1/2	7/8	0.58

TI2

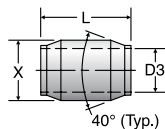
Ferrule
Intru-Lok



TUBE FITTING PART #	TUBE O.D. (in.)	D3 (in.)	L (in.)
2 TI2	1/8	0.13	0.35
3 TI2	3/16	0.19	0.39
4 TI2	1/4	0.26	0.40
5 TI2	5/16	0.32	0.42
6 TI2	3/8	0.38	0.41
8 TI2	1/2	0.51	0.52

TIP*

Expander / Insert

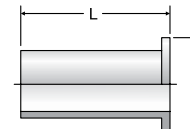


TUBE FITTING PART #	TUBE O.D. (in.)	D3 (in.)	L (in.)	X DIA (in.)
4 TIP	1/4	0.14	0.45	0.22
6 TIP	3/8	0.22	0.45	0.30

* For use with thermoplastic tube and BIP nut.

T23UI

Insert

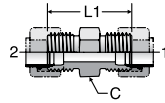


TUBE FITTING PART #	TUBE O.D. (in.)	TUBE WALL THICKNESS (in.)	L (in.)	X DIA (in.)
4 T23UI	1/4	0.040	0.53	0.23
5 T23UI	5/16	0.062	0.56	0.29
6 T23UI	3/8	0.062	0.56	0.35
8 T23UI	1/2	0.062	0.64	0.47

Dimensions and pressures for reference only, subject to change.

HBI2

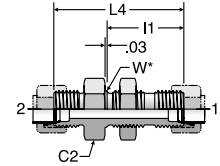
Union
Intru-Lok / Intru-Lok



TUBE FITTING PART #	END SIZE		C HEX (in.)	L1 (in.)	Dynamic Pressure (x 1,000 PSI) -B
	1 (in.)	2 (in.)			
2 HBI2	1/8	1/8	3/8	0.81	1.5
3 HBI2	3/16	3/16	3/8	0.75	1.5
4 HBI2	1/4	1/4	7/16	0.84	1.5
5 HBI2	5/16	5/16	1/2	0.91	1.5
6 HBI2	3/8	3/8	9/16	1.03	1.5
8 HBI2	1/2	1/2	3/4	1.19	1.5

WBI2

Bulkhead Union
Intru-Lok / Intru-Lok



* W – Pilot drill diameter

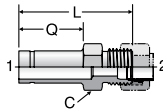
TUBE FITTING PART #	END SIZE		C2 HEX (in.)	L1 (in.)	L4 (in.)	W DIA (in.)	Dynamic Pressure (x 1,000 PSI) -B
	1 (in.)	2 (in.)					
4 WBI2	1/4	1/4	9/16	0.88	1.34	0.44	1.5
6 WBI2	3/8	3/8	11/16	0.94	1.56	0.56	1.5
8 WBI2	1/2	1/2	7/8	1.06	1.75	0.75	1.5

TABLE OF CONTENTS

VISUAL INDEX

TRBI2

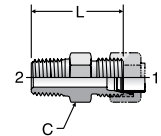
Tube End Reducer
Intru-Lok



TUBE FITTING PART #	END SIZE		C HEX (in.)	L (in.)	Q (in.)	Dynamic Pressure (x 1,000 PSI) -B
	1 (in.)	2 (in.)				
4-3 TRBI2	1/4	3/16	7/16	1.00	0.56	1.5
6-4 TRBI2	3/8	1/4	7/16	1.06	0.59	1.5
8-4 TRBI2	1/2	1/4	9/16	1.30	0.75	1.5

FBI2

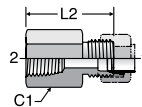
Male Connector
Intru-Lok / NPTF



TUBE FITTING PART #	END SIZE		C HEX (in.)	L (in.)	Dynamic Pressure (x 1,000 PSI) -B
	1 (in.)	2 NPTF			
2 FBI2	1/8	1/8 - 27	7/16	0.86	1.5
3 FBI2	3/16	1/8 - 27	7/16	0.81	1.5
4 FBI2	1/4	1/8 - 27	7/16	0.88	1.5
4-4 FBI2	1/4	1/4 - 18	9/16	1.08	1.5
4-8 FBI2	1/4	1/2 - 14	7/8	1.31	1.5
5 FBI2	5/16	1/8 - 27	1/2	0.94	1.5
5-4 FBI2	5/16	1/4 - 18	9/16	1.14	1.5
6 FBI2	3/8	1/4 - 18	9/16	1.17	1.5
6-2 FBI2	3/8	1/8 - 27	9/16	0.97	1.5
6-6 FBI2	3/8	3/8 - 18	11/16	1.19	1.5
6-8 FBI2	3/8	1/2 - 14	7/8	1.42	1.5
8 FBI2	1/2	3/8 - 18	3/4	1.28	1.5
8-4 FBI2	1/2	1/4 - 18	3/4	1.27	1.5
8-8 FBI2	1/2	1/2 - 14	7/8	1.50	1.5

GBI2

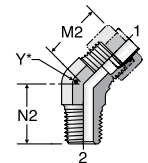
Female Connector
Intru-Lok / NPTF



TUBE FITTING PART #	END SIZE		C1 HEX (in.)	L2 (in.)	Dynamic Pressure (x 1,000 PSI) -B
	1 (in.)	2 NPTF			
2 GBI2	1/8	1/8 - 27	9/16	0.78	1.5
3 GBI2	3/16	1/8 - 27	9/16	0.75	1.5
4 GBI2	1/4	1/8 - 27	9/16	0.80	1.5
4-4 GBI2	1/4	1/4 - 18	3/4	0.97	1.5
6 GBI2	3/8	1/4 - 18	3/4	0.98	1.5
6-2 GBI2	3/8	1/8 - 27	9/16	0.86	1.5
6-6 GBI2	3/8	3/8 - 18	7/8	1.08	1.5
6-8 GBI2	3/8	1/2 - 14	1 1/8	1.23	1.5
8 GBI2	1/2	3/8 - 18	7/8	1.16	1.5
8-4 GBI2	1/2	1/4 - 18	13/16	1.16	1.5
8-8 GBI2	1/2	1/2 - 14	1 1/8	1.31	1.5

VBI2

45° Male Elbow
Intru-Lok / NPTF



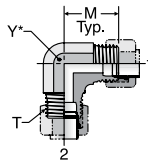
Y* – Across wrench flats

TUBE FITTING PART #	END SIZE		M2 (in.)	N2 (in.)	Y (in.)	Dynamic Pressure (x 1,000 PSI) -B
	1 (in.)	2 NPTF				
4 VBI2	1/4	1/8 - 27	0.50	0.63	7/16	1.5
5 VBI2	5/16	1/8 - 27	0.59	0.63	9/16	1.5
6 VBI2	3/8	1/4 - 18	0.69	0.84	9/16	1.5

Dimensions and pressures for reference only, subject to change.

EBI2

Union Elbow
Intru-Lok / Intru-Lok

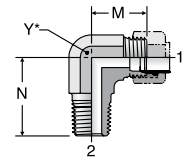


Y* – Across wrench flats

TUBE FITTING PART #	END SIZE		M (in.)	Y (in.)	Dynamic Pressure (x 1,000 PSI) -B
	1 (in.)	2 (in.)			
4 EBI2	1/4	1/4	0.67	7/16	1.5
6 EBI2	3/8	3/8	0.78	9/16	1.5
8 EBI2	1/2	1/2	0.89	3/4	1.5

CBI2

Male Elbow
Intru-Lok / NPTF

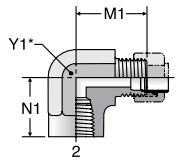


Y* – Across wrench flats

TUBE FITTING PART #	END SIZE		M (in.)	N (in.)	Y (in.)	Dynamic Pressure (x 1,000 PSI) -B
	1 (in.)	2 NPTF				
2 CBI2	1/8	1/8 - 27	0.59	0.69	5/16	1.5
3 CBI2	3/16	1/8 - 27	0.61	0.69	3/8	1.5
4 CBI2	1/4	1/8 - 27	0.63	0.69	3/8	1.5
4-4 CBI2	1/4	1/4 - 18	0.73	0.92	9/16	1.5
5 CBI2	5/16	1/8 - 27	0.66	0.72	9/16	1.5
5-4 CBI2	5/16	1/4 - 18	0.75	0.97	9/16	1.5
6 CBI2	3/8	1/4 - 18	0.78	0.97	9/16	1.5
6-2 CBI2	3/8	1/8 - 27	0.72	0.81	9/16	1.5
6-6 CBI2	3/8	3/8 - 18	0.86	1.00	3/4	1.5
6-8 CBI2	3/8	1/2 - 14	1.00	1.38	5/8	1.5
8 CBI2	1/2	3/8 - 18	0.88	1.00	3/4	1.5
8-4 CBI2	1/2	1/4 - 18	0.88	1.06	3/4	1.5
8-8 CBI2	1/2	1/2 - 14	1.09	1.38	7/8	1.5

DBI2

Female Elbow
Intru-Lok / NPTF

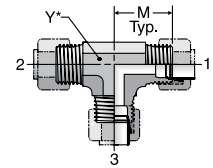


Y1* – Across wrench flats

TUBE FITTING PART #	END SIZE		M1 (in.)	N1 (in.)	Y1 (in.)	Dynamic Pressure (x 1,000 PSI) -B
	1 (in.)	1 NPTF				
2 DBI2	1/8	1/8 - 27	0.69	0.53	9/16	1.5
3 DBI2	3/16	1/8 - 27	0.66	0.53	9/16	1.5
4 DBI2	1/4	1/8 - 27	0.72	0.55	9/16	1.5
4-4 DBI2	1/4	1/4 - 18	0.84	0.69	3/4	1.5
6 DBI2	3/8	1/4 - 18	0.92	0.69	3/4	1.5
6-6 DBI2	3/8	3/8 - 18	1.00	0.81	7/8	1.5
8-8 DBI2	1/2	1/2 - 14	1.13	0.94	1	1.5

JB12

Union Tee
Intru-Lok (all three ends)

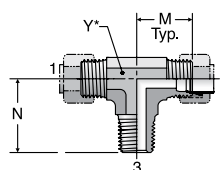


Y1* – Across wrench flats

TUBE FITTING PART #	END SIZE			M (in.)	Y (in.)	Dynamic Pressure (x 1,000 PSI) -B
	1 (in.)	2 (in.)	3 (in.)			
2 JB12	1/8	1/8	1/8	0.63	5/16	1.5
3 JB12	3/16	3/16	3/16	0.59	3/8	1.5
4 JB12	1/4	1/4	1/4	0.59	3/8	1.5
5 JB12	5/16	5/16	5/16	0.66	9/16	1.5
6 JB12	3/8	3/8	3/8	0.72	9/16	1.5
8 JB12	1/2	1/2	1/2	0.88	3/4	1.5

SBI2

Male Branch Tee
Intru-Lok / Intru-Lok / NPTF

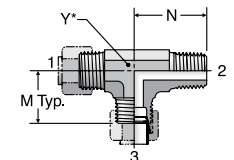


Y* – Across wrench flats

TUBE FITTING PART #	END SIZE			M (in.)	N (in.)	Y (in.)	Dynamic Pressure (x 1,000 PSI) -B
	1 (in.)	2 (in.)	3 NPTF				
2 SBI2	1/8	1/8	1/8 - 27	0.63	0.69	11/32	1.5
4 SBI2	1/4	1/4	1/8 - 27	0.63	0.69	3/8	1.5
4-4-4 SBI2	1/4	1/4	1/4 - 18	0.73	0.97	9/16	1.5
6 SBI2	3/8	3/8	1/4 - 18	0.72	0.91	9/16	1.5

RB12

Male Run Tee
Intru-Lok / NPTF / Intru-Lok



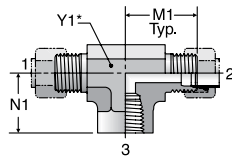
Y* – Across wrench flats

TUBE FITTING PART #	END SIZE			M (in.)	N (in.)	Y (in.)	Dynamic Pressure (x 1,000 PSI) -B
	1 (in.)	2 NPTF	3 (in.)				
2 RB12	1/8	1/8 - 27	1/8	0.63	0.69	5/16	1.5
3 RB12	3/16	1/8 - 27	3/16	0.59	0.69	3/8	1.5
4 RB12	1/4	1/8 - 27	1/4	0.59	0.69	3/8	1.5
4-4-4 RB12	1/4	1/4 - 18	1/4	0.75	0.98	9/16	1.5
6 RB12	3/8	1/4 - 18	3/8	1.05	1.07	9/16	1.5

Dimensions and pressures for reference only, subject to change.

OBI2

Female Branch Tee
Intru-Lok / NPTF

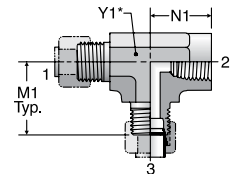


Y* – Across wrench flats

TUBE FITTING PART #	END SIZE			M1 (in.)	N1 (in.)	Y1 (in.)	Dynamic Pressure (x 1,000 PSI) -B
	1 (in.)	2 (in.)	3 NPTF				
4 OBI2	1/4	1/4	1/8 - 27	0.72	0.53	9/16	1.5
4-4-4 OBI2	1/4	1/4	1/4 - 18	0.86	0.69	3/4	1.5
6 OBI2	3/8	3/8	1/4 - 18	0.92	0.69	3/4	1.5
8 OBI2	1/2	1/2	3/8 - 18	1.09	0.81	7/8	1.5

MBI2

Female Run Tee
Intru-Lok / NPTF / Intru-Lok



Y* – Across wrench flats

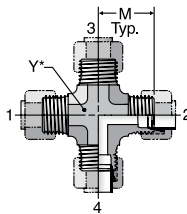
TUBE FITTING PART #	END SIZE			M1 (in.)	N1 (in.)	Y1 (in.)	Dynamic Pressure (x 1,000 PSI) -B
	1 (in.)	2 NPTF	3 (in.)				
4 MBI2	1/4	1/8 - 27	1/4	0.72	0.53	9/16	1.5
6 MBI2	3/8	1/4 - 18	3/8	0.92	0.69	3/4	1.5

TABLE OF CONTENTS

VISUAL INDEX

KBI2

Union Cross
Intru-Lok (all four ends)

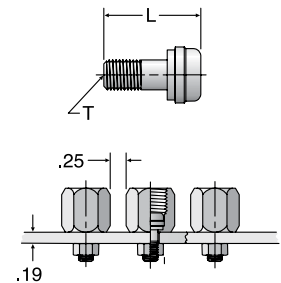


Y* – Across wrench flats

TUBE FITTING PART #	END SIZE				M (in.)	Y (in.)	Dynamic Pressure (x 1,000 PSI) -B
	1 (in.)	2 (in.)	3 (in.)	4 (in.)			
4 KBI2	1/4	1/4	1/4	1/4	0.66	7/16	1.5
6 KBI2	3/8	3/8	3/8	3/8	0.78	1/2	1.5

T22I

Mountie



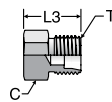
Typical application

TUBE FITTING PART #	TUBE O.D. (in.)	T TUBE END UN/UNF-2A	L (in.)	Dynamic Pressure (x 1,000 PSI) -B
6 T22I*	3/8	1/4 - 20	0.81	1.5

*Non standard

PNI

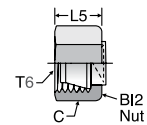
Plug
Intru-Lok



TUBE FITTING PART #	TUBE O.D. (in.)	T TUBE END UN/UNF-2A	C HEX (in.)	L3 (in.)	Dynamic Pressure (x 1,000 PSI) -B
5 PNI	5/16	1/2 - 20	1/2	0.52	1.5
6 PNI	3/8	9/16 - 18	9/16	0.59	1.5
8 PNI	1/2	3/4 - 16	3/4	0.67	1.5

FNI

Cap
Intru-Lok



TUBE FITTING PART #	TUBE O.D. (in.)	C HEX (in.)	L5 (in.)	Dynamic Pressure (x 1,000 PSI) -B
3 FNI	3/16	7/16	0.34	1.5
4 FNI	1/4	1/2	0.44	1.5
5 FNI	5/16	9/16	0.45	1.5
6 FNI	3/8	5/8	0.45	1.5
8 FNI	1/2	7/8	0.58	1.5

Dimensions and pressures for reference only, subject to change.

TABLE
OF
CONTENTS

VISUAL
INDEX











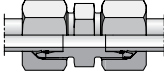
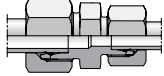
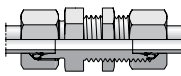

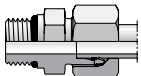
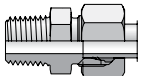
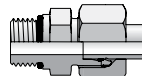
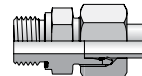




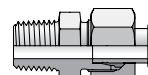
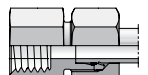
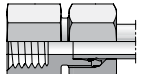
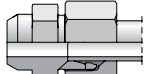
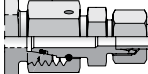
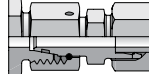
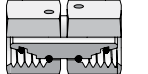
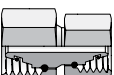
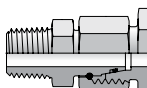
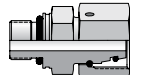
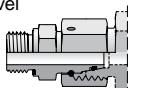
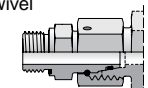

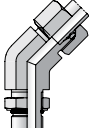
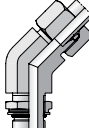
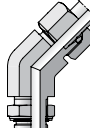
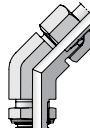
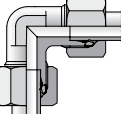
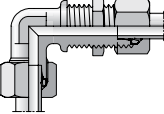
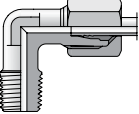
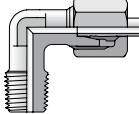
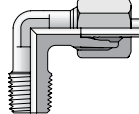
E0 and E0-2 Metric Bite Type Fittings

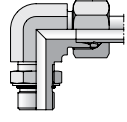
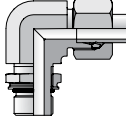
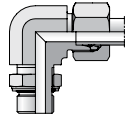
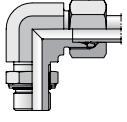
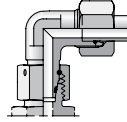
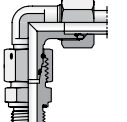
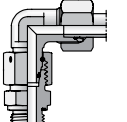
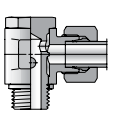
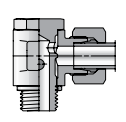
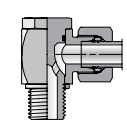
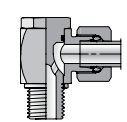
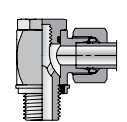
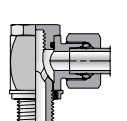
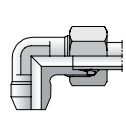
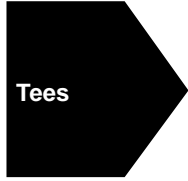
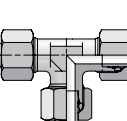
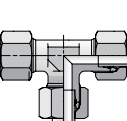
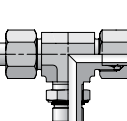
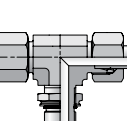
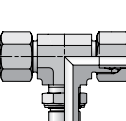
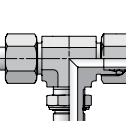
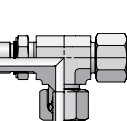
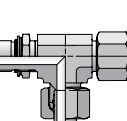
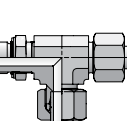
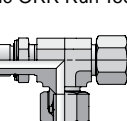
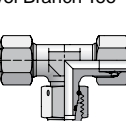
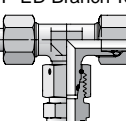
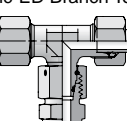
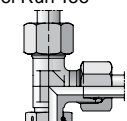
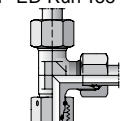
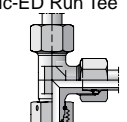
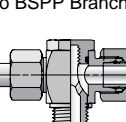
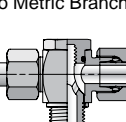
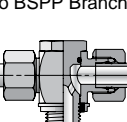
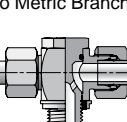
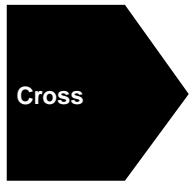
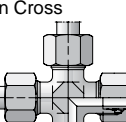

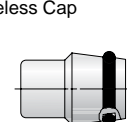
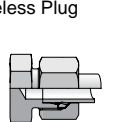

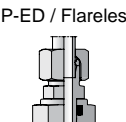
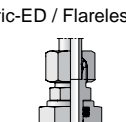
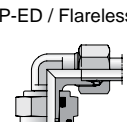
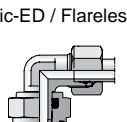
E



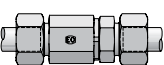
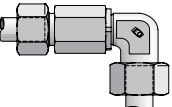
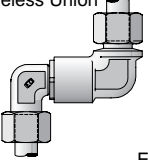
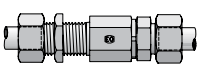
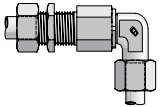
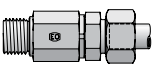
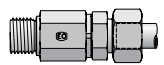
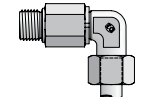
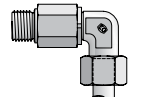
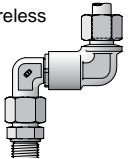
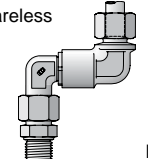
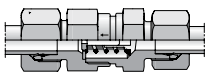
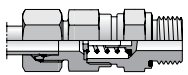
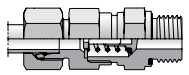
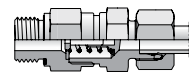
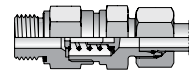
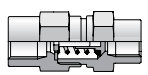

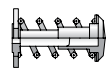
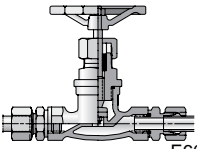
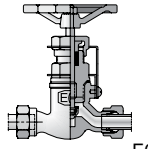
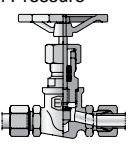
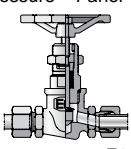
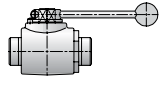
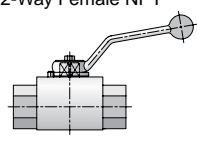
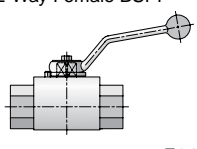
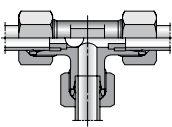
ENGINEERING YOUR SUCCESS.

**TABLE
 OF
 CONTENTS**


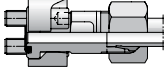
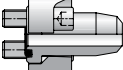
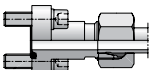
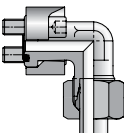
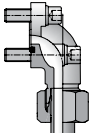
<p>Nuts, Sleeves, Locknut, Inserts</p>	<p>M Nut  E13</p>	<p>FM Functional Nut  E14</p>	<p>DPR Progressive Ring  E13</p>	<p>D Cutting Ring  E13</p>	<p>PSR Progressive Ring  E13</p>
<p>GM Bulkhead Locknut  E15</p>	<p>E Insert for Plastic Tube  E15</p>	<p>VH Insert for Metal Tube  E15</p>	<p>Straights</p>	<p>G Union  E16</p>	<p>GR Reducer Union  E16</p>
<p>SV Bulkhead Union  E17</p>	<p>ESV Weld Bulkhead Union  E17</p>	<p>GE-UNF/UN SAE-ORB / Flareless  E18</p>	<p>GE-NPT NPT / Flareless  E18</p>	<p>GEO ISO 6149 / Flareless  E19</p>	<p>GE-R-ED BSPP-ED / Flareless  E19</p>
<p>GE-R BSPP / Flareless  E20</p>	<p>GE-R keg BSPT / Flareless  E20</p>	<p>GE-M-ED Metric-ED / Flareless  E21</p>	<p>GE-M Metric / Flareless  E22</p>	<p>GE-M keg Metric Taper / Flareless  E22</p>	<p>GAI-R Female BSPP / Flareless  E22</p>
<p>GAI-M Female Metric / Flareless  E23</p>	<p>AS Butt Weld / Flareless  E23</p>	<p>Straight Swivels</p>	<p>RED Tube End Reducer  E24</p>	<p>DA Extender  E25</p>	<p>GZ Swivel Union  E25</p>
<p>GZR Swivel Union Reducer  E25</p>	<p>EGE-NPT NPT / Flareless Swivel  E25</p>	<p>EGEO ISO 6149 / Flareless Swivel  E26</p>	<p>EGE-R-ED BSPP-ED / Flareless Swivel  E26</p>	<p>EGE-M-ED Metric-ED / Flareless Swivel  E26</p>	<p>SKA Butt Weld / Flareless Swivel  E26</p>
<p>45° Elbows</p>	<p>VEE-UNF/UN SAE-ORB / Flareless  E27</p>	<p>VEE-OR ISO 6149 / Flareless  E27</p>	<p>VEE-R BSPP-ORR / Flareless  E28</p>	<p>VEE-M Metric-ORR / Flareless  E28</p>	
<p>90° Elbows</p>	<p>W Union Elbow  E29</p>	<p>WSV Bulkhead Union Elbow  E30</p>	<p>WE-NPT NPT / Flareless  E30</p>	<p>WE-R keg BSPT / Flareless  E31</p>	<p>WE-M keg Metric Taper / Flareless  E31</p>

WEE-UNF/UN SAE-ORB / Flareless  E32	WEE-OR ISO 6149 / Flareless  E32	WEE-R BSPP-ORR / Flareless  E33	WEE-M Metric-ORR / Flareless  E33	EW Flareless Swivel / Flareless  E34	EW-R-ED BSPP-ED / Flareless  E35
EW-M-ED Metric-ED / Flareless  E35	SWVE-R Banjo BSPP / Flareless  E36	SWVE-M Banjo Metric / Flareless  E36	WH-R Banjo BSPP / Flareless  E37	WH-M Banjo Metric / Flareless  E37	WH-R-KDS Banjo BSPP / Flareless  E38
WH-M-KDS Banjo Metric / Flareless  E38	WAS Butt Weld / Flareless  E39	 Tees	T Union Tee  E39	TR Reducer Tee  E40	TEE-UNF/UN SAE-ORB Branch Tee  E41
TEE-OR ISO 6149 Branch Tee  E42	TEE-R BSPP-ORR Branch Tee  E42	TEE-M Metric-ORR Branch Tee  E43	LEE-UNF/UN SAE-ORB Run Tee  E43	LEE-OR ISO 6149 Run Tee  E44	LEE-R BSPP-ORR Run Tee  E44
LEE-M Metric-ORR Run Tee  E44	ET Swivel Branch Tee  E45	ET-R-ED BSPP-ED Branch Tee  E45	ET-M-ED Metric-ED Branch Tee  E46	EL Swivel Run Tee  E46	EL-R-ED BSPP-ED Run Tee  E47
EL-M-ED Metric-ED Run Tee  E47	TH-R Banjo BSPP Branch Tee  E48	TH-M Banjo Metric Branch Tee  E48	TH-R-KDS Banjo BSPP Branch Tee  E49	TH-M-KDS Banjo Metric Branch Tee  E49	
 Cross	K Union Cross  E50	 Caps and Plugs	VKA Flareless Cap  E50	ROV Flareless Plug  E50	
 Plain Bearing Rotary Fittings	DVGE-R BSPP-ED / Flareless  E51	DVGE-M Metric-ED / Flareless  E52	DVWE-R BSPP-ED / Flareless  E51	DVWE-M Metric-ED / Flareless  E52	


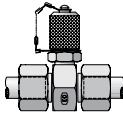
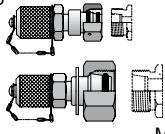


**TABLE
 OF
 CONTENTS**

<p>Ball Bearing Rotary Fittings</p>	<p>DG101 Flareless Union</p>  <p>E53</p>	<p>DG103 Flareless Union</p>  <p>E53</p>	<p>DG105 Flareless Union</p>  <p>E53</p>	<p>DG107 Union Bulkhead</p>  <p>E53</p>	<p>DG108 90° Union Bulkhead</p>  <p>E54</p>
<p>DG102-R BSPP-ED / Flareless</p>  <p>E54</p>	<p>DG102-M Metric-ED / Flareless</p>  <p>E54</p>	<p>DG104-R 90° BSPP-ED / Flareless</p>  <p>E54</p>	<p>DG104-M 90° Metric-ED / Flareless</p>  <p>E55</p>	<p>DG106-R Double Elbow BSPP / Flareless</p>  <p>E55</p>	<p>DG106-M Double Elbow Metric / Flareless</p>  <p>E55</p>
<p>Check Valves</p>	<p>RHD Union</p>  <p>E56</p>	<p>RHV-R-ED BSPP-ED / Flareless</p>  <p>E56</p>	<p>RHV-M-ED Metric-ED / Flareless</p>  <p>E57</p>	<p>RHZ-R-ED BSPP-ED / Flareless</p>  <p>E57</p>	<p>RHZ-M-ED Metric-ED / Flareless</p>  <p>E58</p>
<p>RHDI Female BSPP Union</p>  <p>E58</p>	<p>RVP Cartridge</p>  <p>E59</p>	<p>I-TL Internal Parts</p>  <p>E59</p>	<p>Shut-Off Valves</p>	<p>DV Low Pressure</p>  <p>E60</p>	<p>LD Medium Pressure</p>  <p>E60</p>
<p>VDHA High Pressure</p>  <p>E61</p>	<p>VDHB High Pressure – Panel Mount</p>  <p>E61</p>	<p>Ball Valves</p>	<p>KH 2-Way Flareless Union</p>  <p>E62</p>	<p>KH-NPT 2-Way Female NPT</p>  <p>E64</p>	<p>KH-R 2-Way Female BSPP</p>  <p>E64</p>
<p>Alternating Valves</p>	<p>WV Union Tee</p>  <p>E65</p>				








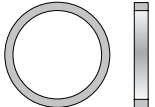
Flange Adapters (Shown in Section L)

 <p>Flange Adapters</p>	<p>GFS Code 61, 62 / Metric Flareless</p>  <p>L14</p>	<p>AS Code 61, 62 / Weld Butt – Tube Metric</p>  <p>L26</p>	<p>BFG DIN Flange / Metric Flareless</p>  <p>L15</p>	<p>WFS Code 61, 62 / Metric Flareless</p>  <p>L33</p>	<p>BFW DIN Flange / Metric Flareless</p>  <p>L34</p>
---	--	--	--	--	---

Diagnostic and Specialty Adapters (Shown in Section M)

 <p>Test Point Connectors</p>	<p>GMA3 EO Tube / EO Tube / EMA-3 Diagnostic Tip</p>  <p>M5</p>	<p>VKA3 EO Swivel / Diagnostic Tip</p>  <p>M8</p>	<p>MAVE BSPP Gauge / EO Swivel</p>  <p>M6</p>	<p>MAV BSPP Gauge / EO Tube</p>  <p>M6</p>
---	--	--	--	---

O-Rings and Seals (Shown in Section N)

 <p>O-Rings and Seals</p>	<p>KDS Bonded Seal for Banjo Fittings</p>  <p>N8</p>	<p>DKA Metal Seal for Banjo Fittings</p>  <p>N8</p>	<p>DKI Pressure Gauge Sealing Ring</p>  <p>N9</p>	<p>EO EOlastic Seal Ring</p>  <p>N6</p>	<p>OR EO O-Ring</p>  <p>N10</p>
	<p>DOZ EO-2 Sealing Ring</p>  <p>N7</p>	<p>RR Metric Retaining Ring</p>  <p>N5</p>			

EO Progressive Ring Fittings — Introduction

The flareless bite type fitting was pioneered by Ermeto in Germany in the early 1930's. When Parker Hannifin acquired Ermeto, it introduced the EO fittings to the US. Today, the EO fittings are the most widely used bite type fittings in the world.

The EO progressive ring fitting is a flareless metric fitting (for metric tube) that consists of a body, a progressive ring (ferrule) and a nut. On assembly, two cutting edges of the progressive ring "bite" into the outer surface of the tube ensuring the necessary holding power and seal for high operating pressures.

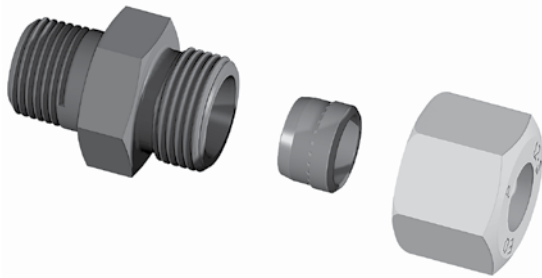


Fig. E1 — EO fitting components: Body, progressive ring and nut

The fittings and components listed in this catalog are intended solely for the assembly of connections for fluid applications.

Three series of EO tube fittings (LL, L and S) and accessories are manufactured in accordance with DIN 2353 (summary) which today is represented by international standard 8434-1 on the basis of decades of experience.*

To ensure functional safety of EO tube fittings, only EO parts should be used in their assembly. Routing of tubes should be carried out in accordance with Parker/EO recommended practices. Assembly instructions are available.

Design and Construction

The three components of EO fittings are designed and manufactured to produce a strong, reliable, leak-free joint upon proper assembly.

The EO Body. EO fitting bodies are available in over thirty configurations. The shaped products (i.e., elbows, tees, crosses) are hot forged, then machined to the stringent EO fitting specifications. The forging process used by Parker further improves the strength and metallurgical properties of the fitting material.

Straight products are made from cold drawn bar stock. The cold drawing operation ensures consistently tight dimensional tolerances, as well as significantly improved strength.

The EO Progressive Ring (Cutting Ring). EO progressive rings are precision machined with all dimensions and surfaces, particularly the critical bite edges, monitored on an ongoing basis. The rings are then heat treated in a manner that provides

the hardness, strength, and toughness necessary to satisfy the demanding service conditions that exist in industry today. The original progressive ring, known as DPR, is now being replaced with the new generation, called PSR. PSR is stronger and features a "positive stop" to eliminate over-tightening.

The EO Nut. EO fitting nuts are either cold formed, hot formed or machined from cold drawn material. The cold forming and cold drawing operations provide a more tightly packed grain structure, thus improving the material's strength. In addition, cold forming significantly improves the fatigue properties or endurance limits of the nuts.

Standard Material Specifications

Steel fittings:

EO tube fittings – Materials according to DIN 3859-1

Stainless steel fittings:

EO tube fittings – X6CrNiMoTi 17122 in accordance with DIN 17440 / EN 10088, material no. 1.4571.

Brass fittings:

EO tube fittings – CUZN35Ni2 in accordance with DIN 17660, material no. 2.0540.

Elastomer seals: NBR (BUNA-N), FKM (Fluorocarbon)

Surface Finish - Steel fittings:

Standard		
LL Series	Body, Nuts, and Rings	– Zinc clear chromate, Chromium 6 Free
L+S Series	Body and Nuts	– Zinc clear chromate, Chromium 6 Free
	Progressive Rings (PSR)	– Zinc clear chromate, Chromium 6 Free

Short codes for surface protection procedure in accordance with DIN 267 part 9 or DIN 50942.

How EO Fittings Work: Function of Progressive Ring Fittings

The EO progressive ring fitting produces a low to high pressure, leak free connection of tubes and components in fluid systems. The basic function of the EO progressive ring is the controlled progressive bite of the ring into the tube due to a unique internal geometry.

The front cutting edge has already started cutting into the tube before the second cutting edge starts. As soon as both cutting edges have cut the tube to the designed depth further advance is limited by the stop edge.

Owing to the design of both cutting edges and stop edge all forces arising are equally distributed. This distribution along with the specially designed interior collar of the ring guarantees increased robustness, particularly with regard to vibration and flexure stresses. The design and function of the progressive cutting ring ensure that service vibration loading is not present in the areas of the tubing where the bite is made.

*The selection of LL, L or S design should be made by the user on the basis of intended system pressure. The pertinent maximum recommended working pressures are shown throughout this catalog in individual data charts of the various fitting configurations.

The stop edge causes a sharp increase in tightening forces which is clearly perceptible. After assembly, a visible collar of cut tube material must completely fill the space in front of the first cutting edge. With stainless steel tube and hose connections made from free cutting steel, the collar is less due to the harder material.

During assembly, it is absolutely essential that the tube is held firmly against the stop in the inner cone of the fitting; if not, the cutting process will not take place satisfactorily. Reassembly can be performed an unlimited number of times.

Assembly and Installation

Please refer to Section S for the assembly and installation instructions for EO and EO-2 Metric Bite type fittings.

Weld Nipples

EO weld nipple fittings with an O-ring seal between weld nipple and body give impressive pull out resistance and sealing integrity, and a sensible alternative to the progressive ring. Fittings bodies and nuts are fully interchangeable for weld nipple and progressive ring fittings of the same series and tube outside ring diameter. Weld nipples SKA conform to DIN 3865 form A, which today is represented by international standard ISO 8434-4.

Ball Bearing Rotary Fittings

DG Ball Bearing Rotary Fittings: These compact, maintenance-free construction, service proven fittings combine ball and plain bearings with constant lubrication and relatively wear resistant annular piston seals. They are rated for working pressures up to 250 bar, have a low starting torque and have a suitable pressure/RPM rate.

Ball bearing rotary fittings are designed for connecting a fixed point to a rotating, swiveling or moving machine part via tubing or hoses. Thus axial torsion of tubing or hoses can be prevented. They are suitable for hydraulic oils and lubricants of mineral oil base, not suitable for water or gases. Nominal temperature range is -25°C to +80°C.

Fitting Instructions:

The life of rotary fitting depends considerably in a stress-free line connection. Therefore, the direct connection with tube is to be avoided. For connection to hoses the use of swivel nut fittings is recommended with short, straight lines (approx. length 5x hose O.D.). Thus shocks and vibrations can be absorbed.

Assemble tube ends in accordance with the Tube End Assembly Information on pages S12 through S13. Assemble BSPP and metric stud ends in accordance with torque values on page S5.

Plain Bearing Rotary Fittings

Plain Bearing Rotary Fittings: These compact, maintenance-free construction, service proven fittings are rated for low pressure tube and hose with slow rotating, swiveling or moving machine parts up to 64 bar (L series) and 160 bar (S series).

Plain bearing rotary fittings are designed for connecting a fixed point to a rotating, swiveling or moving machine part via tubing or hoses. Thus axial torsion of tubing or hoses can be prevented. They are suitable for hydraulic oils and lubricants of mineral oil base, not suitable for water or gases. Nominal temperature range is -35°C to +100°C.

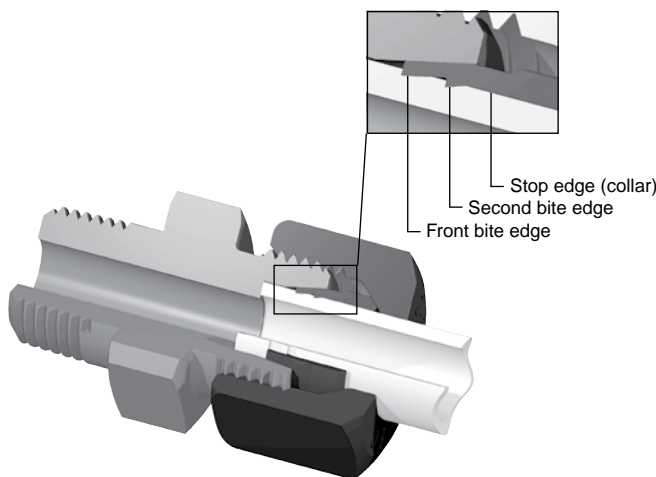


Fig. E2 — How EO fittings work

Tube O.D.	Nominal bore (mm)	Permissible number of revolutions (rpm) under a working pressure** of:					Torque at 250 bar/Nm
		25 bar	64 bar	100 bar	160 bar	250 bar	
6 8	5.0	1500	750	400	200	85	0.08
12 16	9.5	800	400	200	100	45	0.24
20 25	16.0	300	150	75	38	15	0.8
30 38	26.0	200	100	50	25	10	2.0

Table E1 — Ball Bearing Recommended RPM and Starting Torques

**A minimum working pressure of 10 bar is necessary.

Series L Tube O.D.	6	8	10	12	15	18	22	28	35	
Permissible RPM	28	28	21	17	13	10	10	7	7	
Series S Tube O.D.	6	8	10	12	14	16	20	25	30	38
Permissible RPM	11	11	9	7	5	5	4	4	3	3

Table E2 — Plain Bearing Recommended RPM

TABLE OF CONTENTS

VISUAL INDEX

E

Fitting Instructions:

The life of a rotary fitting depends considerably in a stress-free line connection. Therefore, the direct connection with tube is to be avoided. For connection to hoses, the use of swivel nut fittings is recommended with short, straight lines (approx. length 5x hose O.D.). Thus, shocks and vibrations can be absorbed.

Non-Return Valves

Characteristics: Sealing is achieved by using a 90° cone with a packing washer of synthetic material. Valve has a lift stop which provides safe free outlet, shock-absorbing, muffled opening and no reduction of cross section. Maximum flow velocity not more than 8 m/sec (for higher flow velocities special tests are required).

Opening Pressure: Approximately 1 bar standard (on request also 0.2, 0.5, 2, 3, 4, 5 & 6 bar are available). Please specify nonstandard opening pressures on order as follows: Tube Fitting part number, opening pressure, material. Ex: RHD12L2BCF is a RHD12LCF with 2 bar opening pressure. Tolerance of (cracking) pressure is ±20%.

Tube Recommendations

For steel and stainless steel tube recommendations, as well as tube wall thickness information, please refer to Metric Tube, Section Q.

Seamless cold drawn steel tubes made from material St. 35.4 or from conditioned base material St. 37.4 in accordance with DIN 1630, state of delivery NBK (normal annealed) with tube outer and inner diameter tolerances in accordance with DIN 2391/ISO 3304. Max. hardness: HRB 75.

**For stainless steel fittings:
Material no. 1.4571 and 1.4541**

Seamless drawn tubes made from austenitic, stainless steel materials no. 1.4571 and 1.4541, in accordance with DIN/EN/ISO 1127. Max. hardness: HRB 90.

These tubes are particularly recommended for tube fittings, since the tube outer diameter and wall thickness, tolerances correspond to those of steel tubes in accordance with DIN 2391/ISO 3304.

For brass fittings:

Seamless drawn copper tube made from material with short code SF-Cu F37 in accordance with DIN 1786.

Tube wall thicknesses:

In order to determine the necessary tube wall thicknesses for applications, refer to the calculated pressures provided in the tables for EO metric tubing. The calculated pressures DIN 2413-I are for static and DIN 2413-III for dynamic loads.

The maximum wall thickness is based on the pressure holding capacity of the fitting. In some cases, the wall thickness of the tube might be too thin for reliable service and an insert must be used to prevent excessive tube collapse. See assembly section for recommended tube wall thicknesses.

Plastic tube:

EO fittings are suitable for use with various types of plastic tubes such as nylon, polyethylene, etc. When used with plastic tube, an insert (see page E15) must be used to prevent tube pull out due to tensile loading.

Features, Advantages & Benefits

- **Visible Bite** — The critical front bite of the progressive ring is clearly visible to tube fitters & inspectors. The presence of the recommended bite virtually eliminates any risk of catastrophic blow-off. This is a very important safety feature.
- **Sealing Capability** — EO fittings have demonstrated a remarkable ability to remain leak free under various service conditions ranging from sealing high vacuum and small molecules gases to high pressure hydraulic fluids.
- **Distributed Stresses** — Stresses due to service flexural loading are distributed at several points in the joint, thus stress concentration in the bite is minimized.
- **Vibration Control** — The rear bevel of the ferrule firmly grips tubing, thus dampening the effects of system vibration in the joint.
- **Progressive Ring Design** — The progressive ring design provides a second bite for improved reliability and higher working pressure capability. This design also decreases the risk of improper assembly because of the sharp, high torque rise which occurs when the fitting is properly tightened.
- **Envelope Size** — EO fittings are relatively small and compact, making it a suitable selection for plumbing in limited or tight space.
- **Temperature Rating** — EO fittings are suitable for sub-zero through elevated temperature applications. Service temperature rating is limited by the material chosen.
- **Compatibility** — Since EO fittings can be manufactured from a wide range of metals, its compatibility factor with various fluids and atmospheric conditions is virtually limitless. One simply has to select and specify EO fittings from an acceptable material that best satisfies the service conditions.
- **Tube Wall** — EO fittings are suitable for use with light wall, medium wall, heavy wall, and extra heavy wall tubing. (Light wall tube may require support sleeve (VH), as shown in Assembly/Installation Section.)
- **Re-Usability / Remakeability** — Joints can be disassembled and reassembled many times to facilitate system maintenance. This reduces the labor and material costs that would otherwise result from tube and fittings replacement.
- **Assembly** — No expensive, complicated tooling is necessary to assemble EO fittings. Assembly is simple when the procedures described in the Assembly / Installation section are followed (see pages S28 - S33).
- **Materials** — EO fittings can be manufactured from almost any metallic material. The more popular materials currently used for EO fittings are: stainless steel, carbon steel, and brass. On request, the Tube Fitting Division will machine EO fittings from other appropriate material specified by users.
- **Manufacture** — EO fittings are manufactured under tight quality control which ensures that the product routinely satisfies or surpasses the requirements of the pertinent industrial standards.
- **World Wide Popularity** — The bite type fitting design has worldwide acceptance and is especially popular in Europe.
- **Superior Plating:** Superior plating gives Parker steel tube fittings unmatched protection against red rust. In neutral salt spray test per ASTM B117, Parker EO and EO2 fittings substantially exceeded the SAE requirement of 96 hours to red rest.

TABLE
OF
CONTENTS

VISUAL
INDEX

- **Finish** — Steel EO fittings have a zinc clear Chromium-6 Free finish. This finish provides good corrosion protection.
- **Silver Plated Nuts** — Stainless steel tube nuts are pre-lubricated with silver plated threads (size 15L-42L, 12S-38S). Thread galling is eliminated and assembly torque is reduced as much as 40 percent. This increases the speed and efficiency for stainless steel fitting assembly.
- **Availability** — EO fittings are available as standard in over thirty different configurations, and as many as twenty-seven different size combinations in some configurations.
- **Configurations** — Popular configurations for EO fittings are shown in the Visual Index. Other configurations can be manufactured on request.

Design and Construction

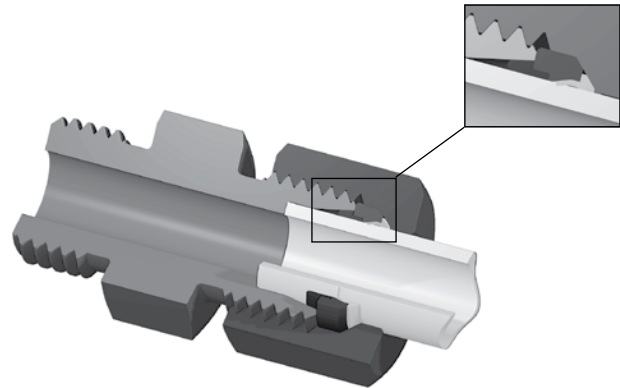


Fig. E4 — EO-2: The metallic support of the sealing ring acts just like an integrated preassembly tool.

EO-2 Fitting System — Introduction

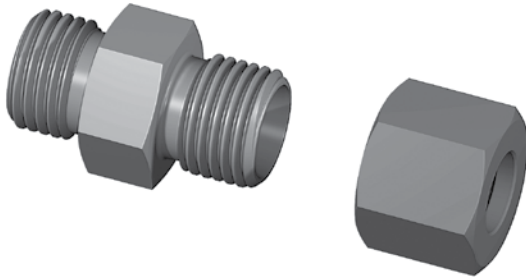


Fig. E3 — EO-2: Fitting body and functional nut

The EO-2 high pressure tube fitting generation is the most recent development of the Tube Fitting Division Europe. It was introduced in an effort to eliminate leakage in all fluid systems.

The common feature of all EO-2 fittings is elastomeric seals on all joints. This assures leakfree operation without retightening — even under severe working conditions. Another breakthrough in bite-type technology is the simple assembly and cost-saving handling of the unique EO-2 Functional Nut.

EO-2 is a true metric design according to 24° bite-type standards such as: ISO 8434-1, DIN 2353 or DIN 3861. It covers all three series (LL, L and S) of the broad EO tube fitting program.

This resulted in a great acceptance with equipment manufactures that are targeting an absolute leakfree systems without sacrificing the convenience of using metric bite type fittings.

Elastomeric Sealing

The elastomeric seal assures a hermetically sealed tube joint. It is located in between the inner cone of the fitting body and the tube surface, thus blocking the only possible leak path. Due to its large cross-section, the seal effectively compensates for all manufacturing tolerances on tube and fitting cone.

The sealing effect is pressure supported which makes the EO-2 fitting suitable for high pressure applications. The static compression also eliminates air-ingress into the fluid system at underpressure conditions.

Elastomerically sealed EO-2 fittings do not require any retightening even in heavy-duty applications. Seal extrusion is prevented by proper housing without gaps or dead volume. The sealing lip is bonded to a metallic support ring.

Standard Material Specifications

Steel fittings:

EO-2 tube fittings — Materials according to DIN 3859-1

Stainless steel fittings:

EO-2 tube fittings — X6CrNiMoTi 17122 in accordance with DIN 17440 / EN 10088, material no. 1.4571.

Brass fittings:

EO-2 tube fittings — CUZN35Ni2 in accordance with DIN 17660, material no. 2.0540.

Elastomer seals: NBR (BUNA-N), FPM (Fluorocarbon)

Surface Finish - Steel fittings:

Standard

LL Series	Body, Nuts, and Rings	- Zinc clear chromate, Chromium 6 Free
L+S Series	Body and Nuts	- Zinc clear chromate, Chromium 6 Free

Short codes for surface protection procedure in accordance with DIN 267 part 9 or DIN 50942.

TABLE OF CONTENTS

VISUAL INDEX

E

How EO-2 Fittings Work

The retaining ring bites into the tube in accordance to the proven bite ring principle. The elastomeric seal reduces the danger of over- or underassembly by a special EO-2 design feature: Before assembly there is a gap in between the flat surfaces of the retaining ring and the metallic support ring of the seal. As soon as the retaining ring has reached the proper incision depth, the gap closes, resulting in a sharp increase of assembly torque. This results in uniform and reliable fitting assemblies. The assembly result can easily be inspected by just checking if the gap is closed.

The separation of sealing and holding functions to two separate elements finally allows a more effective solution of the over- and undertightening problems typically associated with bite type fittings.

Assembly and Installation

Please refer to Section S for the assembly and installation instructions for EO and EO-2 Metric Bite type fittings.

Integrated Assembly Tool

The metallic support ring of the seal is made of a specially designed material and heat-treatment to act as an assembly tool. This makes sure that the retaining ring securely cuts into the tube surface without damaging the sensitive inner cone of the fitting body.

This unique feature of EO-2 fittings even allows direct assembly of tube without any additional pre-assembly process. An EOMAT machine (or other hydraulic tool) is strongly recommended to allow easy assembly of large dimension tube and drastically save total assembly time, effort and costs. The integrated assembly tool of EO-2 fittings even helps to save further costs and trouble when using an EOMAT-type presetting machine: As the presetting cone is only in contact with the elastomeric sealing lip, it cannot be worn out or damaged even after thousands of assemblies. This not only saves replacement costs but also avoids leakage problems caused by worn presetting tools.

The Functional Nut

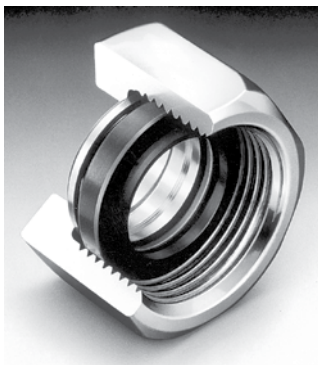


Fig. E5 — The unique Functional Nut allows easy handling and quick assembly.

The unique Functional Nut simplifies handling of fitting components and helps to minimize storage and procurement costs.

The sealing and retaining rings are combined as a pair and are inserted into the internal thread of the nut in such a manner that they cannot fall out, so that these three parts form one functional element.

Individual components such as seal or retaining ring cannot be forgotten, confused or assembled in the wrong orientation. Time and cost are saved by eliminating searching and arranging the components to make up individual joints.

Functional Nuts are completely interchangeable with the full range of EO tube fitting ends.

After assembly and disassembly, the sealing ring can be replaced individually without cutting off the tube end.

Tube Recommendations

For steel fittings:

Seamless cold drawn steel tubes made from material St. 35.4 or from conditioned base material St. 37.4 in accordance with DIN 1630, state of delivery NBK (normal annealed) with tube outer and inner diameter tolerances in accordance with DIN 2391/ISO 3304. Max. hardness: HRB 75.

For stainless steel fittings: Material no. 1.4571 and 1.4541

Seamless drawn tubes made from austenitic, stainless steel materials no. 1.4571 and 1.4541, in accordance with DIN/EN/ISO 1127. Max. hardness: HRB 90.

These tubes are particularly recommended for tube fittings, since the tube outer diameter and wall thickness, tolerances correspond to those of steel tubes in accordance with DIN 2391/ISO 3304.

Tube wall thicknesses:

In order to determine the necessary tube wall thicknesses for applications, refer to the calculated pressures provided in the tables for EO metric tubing. The calculated pressures DIN 2413-I are for static and DIN 2413-III for dynamic loads.

The maximum wall thickness is based on the pressure holding capacity of the fitting. In some cases, the wall thickness of the tube might be too thin for reliable service and an insert must be used to prevent excessive tube collapse. See assembly section for recommended tube wall thicknesses.

Plastic tube:

EO-2 fittings are suitable for use with various types of plastic tubes such as nylon, polyethylene, etc. When used with plastic tube, an insert (see page E15) must be used to prevent tube pull out due to tensile loading.

Features, Advantages and Benefits of the EO-2 Fitting System

In addition to the general advantages of the EO tube fitting system, the unique EO-2 fitting features offer even more specific benefits:

- **Sealing Capability** — An elastomeric seal forms the primary sealing element, thus assuring leak-free sealing. Even low-viscosity media such as water or gas are hermetically sealed. Hydraulic systems, therefore, do not “sweat” at fittings.
- **High Pressure Resistance** — EO-2 fittings are rated up to Pmax 900 bar. Sealing lip and seal arrangements have both been designed so that the sealing effect is supported by system pressure. The interaction of the retaining ring and the integrated preassembly tool results in uniform and reliable fitting assembly.
- **Durability** — The elastomeric seal does not require any retightening even after years of operation under severe working conditions.
- **Bite Control** — The ideal bite depth is controlled by the fitting design rather than by the fitters force. Closing the gap at the end of the manual assembly, the fitter gets clear signal that setting is completed and the joint is ready for inspection.
- **Functional Nut** — Individual components such as the retaining ring or seal cannot be lost, forgotten, confused or assembled in the wrong orientation. This dramatically saves assembly cost and helps to avoid dangerous assembly errors.
- **Assembly Cost** — With less than 10 seconds cycle time on the EOMAT III/A (actual presetting process: 1.4 seconds), the cost of presetting EO-2 is extremely low.
- **Integrated Preassembly Tool** — Each EO-2 Functional Nut comes assembled with an integrated assembly tool that makes sure that the retaining ring securely cuts into the tube surface without damaging the sensitive inner cone of the fitting body. This greatly reduces the danger of tube blow-off, even when using stainless steel tube.
- **Unlimited Presetting Tool Lifetime** — When EOMAT machines are used for cost-efficient presetting, the preassembly tools do not wear out as they are only in contact with the rubber seal. This avoids dangerous blow-off which can result when traditional bite-type fittings are assembled using worn presetting tools.
- **Make-up** — From the wrench-tight position of the preset EO-2 joint, one short pull on the wrench (approx. 1/6 to 1/4 turn) gives the assembly a quick high rise to required torque. EO-2 fittings have a solid “hit-home-feel” and excellent over-torque resistance.
- **Visible Inspection** — There is no doubt if an EO-2 Functional Nut has been preset correctly or not. Inspection is as simple as checking if the gap between retaining ring and sealing ring is completely closed. The tube end does not have to be disassembled out of the fitting for bite inspection.
- **No Phantom Leaks** — Lubrication is not mandatory for the assembly of steel EO-2 fittings. The machine operator will not be irritated about lubricant coming out of the fittings once the hydraulic system gets hot.
- **Re-Usability/Remakeability** — EO-2 fittings can be disassembled and reassembled many times. There is no wear or widening of the vulnerable inner cone. Damaged seals can easily be replaced. All spare DOZ-seals are marked by size-code (e.g.: 12-L).
- **On-Site Maintenance** — For the maintenance and replacement of EO-2 fittings a set of wrenches is sufficient. Additional in line components, such as test points (GMA), ball valves (KH) or T-fittings can be added to an existing assembly within minutes.
- **Interchangeability** — The EO-2 Functional Nut can be used for the whole variety of the broad range of more than 50 configurations in some 25 sizes of standard EO LL, L and S-series fittings. Changeover from Progressive ring or weld nipple is easy by the simple use of EO-2 Functional Nuts.
- **Reliability** — Millions of EO-2 fittings are working trouble-free in applications like: Mobile construction equipment, stationary machine tools, hydraulic presses, plastic injection molding machines, shipbuilding, offshore exploration, submarines, railway trains and military equipment. Leakage does not occur on EO-2 pipework.
- **Trouble-Free** — Regular bite type fittings allow typical assembly-errors such as: confusion of bite type ring material and size. Also, the use of worn-out preassembly tool may result in fitting failure. The clever EO-2 design eliminates most of these mistakes without making the assembly process more complicated.
- **Popularity** — EO-2 fittings are as easy to assemble as traditional bite type fittings, but they eliminate most of their typical assembly problems. EO-2 fittings are therefore appreciated by an increasing number of original equipment manufacturers. EO-2 also has become the fitting of choice of end-users that appreciate the leakfree performance, the easy maintenance and the global availability of the metric soft-seal bite type system.

TABLE
OF
CONTENTS

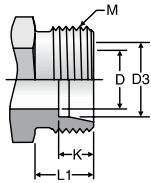
VISUAL
INDEX

E

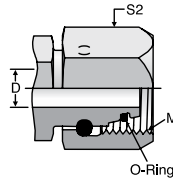
EO and EO-2 Metric Tube Ends

TABLE OF CONTENTS

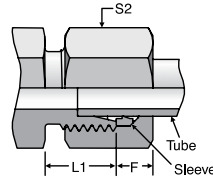
VISUAL INDEX



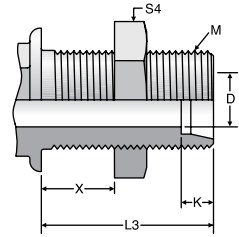
EO/EO-2 Male Tube End



EO/EO-2 Swivel



EO/EO-2 Assembly



EO/EO-2 Bulkhead

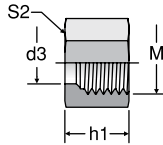
Size	End Size	Thread Metric	Drill D (mm)	Tube Nut Assembled Allowance	Tube Depth	Male Turn Back	Bulkhead Length	Tube/Swivel Nut Hex	Bulkhead Nut Hex	Max Bulkhead Thickness
	D3 (mm)			F (mm)	K (mm)	L1 (mm)	L3 (mm)	S2 (mm)	S4 (mm)	X (mm)
4LL	4	M8x1	3	5.5	4.2	8	—	10	—	—
6LL	6	M10x1	4.5	6	5.7	8	—	12	—	—
8LL	8	M12x1	6	6	5.7	9	—	14	—	—
10LL	10	M14x1	8	6	5.7	9	—	17	—	—
12LL	12	M16x1	10	6	6.2	9	—	19	—	—
6L	6	M12x1.5	4	8	7.2	10	34	14	17	16
8L	8	M14x1.5	6	8	7.2	10	34	17	19	16
10L	10	M16x1.5	8	8	7.2	11	35	19	22	16
12L	12	M18x1.5	10	8	7.2	11	36	22	24	16
15L	15	M22x1.5	12	8	7.2	12	38	27	30	16
18L	18	M26x1.5	15	9	7.7	12	40	32	36	16
22L	22	M30x2	19	9	7.7	14	42	36	41	16
28L	28	M36x2	24	9	7.7	14	43	41	46	16
35L	35	M45x2	30	11	10.7	16	47	50	55	16
42L	42	M52x2	36	12	11.2	16	47	60	65	16
6S	6	M14x1.5	4	8	7.2	12	36	17	19	16
8S	8	M16x1.5	5	8	7.2	12	36	19	22	16
10S	10	M18x1.5	7	9	7.7	12	37	22	24	16
12S	12	M20x1.5	8	9	7.7	12	38	24	27	16
14S	14	M22x1.5	10	10	8.2	14	40	27	30	16
16S	16	M24x1.5	12	10	8.7	14	41	30	32	16
20S	20	M30x2	16	11	10.7	16	44	36	41	16
25S	25	M36x2	20	12	12.2	18	47	46	46	16
30S	30	M42x2	25	13	13.7	20	51	50	50	16
38S	38	M52x2	32	15	16.2	22	53	60	65	16

Note: For port and stud end dimensions reference section F: Pipe Fittings and Port Adapters.

Dimensions and pressures for reference only, subject to change.



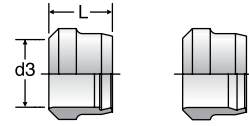
M
Nut



STANDARD FROM STOCK			d3 Tube O.D. (mm)	M Metric Thread	S2 (mm)	h1 (mm)
TUBE FITTING PART #						
STEEL	STAINLESS	BRASS				
M04LLCFX	M04LL71X	M04LLMSX	4	M8 x 1	10	11.0
M06LLCFX	M06LL71X	M06LLMSX	6	M10 x 1	12	11.5
M08LLCFX	M08LL71X	M08LLMSX	8	M12 x 1	14	12.0
M10LLCFX	—	M10LLMSX	10	M14 x 1	17	12.5
M12LLCFX	—	M12LLMSX	12	M16 x 1	19	13.0
M06LCFX	M06LEODURX	M06LMSX	6	M12 x 1.5	14	14.5
M08LCFX	M08LEODURX	M08LMSX	8	M14 x 1.5	17	14.5
M10LCFX	M10LEODURX	M10LMSX	10	M16 x 1.5	19	15.5
M12LCFX	M12LEODURX	M12LMSX	12	M18 x 1.5	22	15.5
M15LCFX	M15LEODURX	M15LMSX	15	M22 x 1.5	27	17.0
M18LCFX	M18LEODURX	M18LMSX	18	M26 x 1.5	32	18.0
M22LCFX	M22LEODURX	M22LMSX	22	M30 x 2	36	20.0
M28LCFX	M28LEODURX	M28LMSX	28	M36 x 2	41	21.0
M35LCFX	M35LEODURX	M35LMSX	35	M45 x 2	50	24.0
M42LCFX	M42LEODURX	M42LMSX	42	M52 x 2	60	24.0
M06SCFX	M06SEODURX	M06SMSX	6	M14 x 1.5	17	16.5
M08SCFX	M08SEODURX	M08SMSX	8	M16 x 1.5	19	16.5
M10SCFX	M10SEODURX	M10SMSX	10	M18 x 1.5	22	17.5
M12SCFX	M12SEODURX	M12SMSX	12	M20 x 1.5	24	17.5
M14SCFX	M14SEODURX	M14SMSX	14	M22 x 1.5	27	20.5
M16SCFX	M16SEODURX	M16SMSX	16	M24 x 1.5	30	20.5
M20SCFX	M20SEODURX	M20SMSX	20	M30 x 2	36	24.0
M25SCFX	M25SEODURX	M25SMSX	25	M36 x 2	46	27.0
M30SCFX	M30SEODURX	M30SMSX	30	M42 x 2	50	29.0
M38SCFX	M38SEODURX	M38SMSX	38	M52 x 2	60	32.5

DPR

Progressive Ring
For L and S series only



DPR: Progressive Ring
D: Cutting Ring

D

Cutting (Locking) Ring
For LL series and all brass

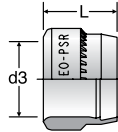
STANDARD FROM STOCK			d3 Tube O.D. (mm)	L (mm)
TUBE FITTING PART #				
STEEL	STAINLESS	BRASS		
D04LLX	—	D04LLMSX	4	6.0
D06LLX	D06LL71X	D06LLMSX	6	7.0
D08LLX	D08LL71X	D08LLMSX	8	7.0
D10LLX	—	D10LLMSX	10	7.0
D12LLX	—	D12LLMSX	12	7.5
—	DPR06L71X*	D06LMSX*	6	9.0
—	DPR08L71X*	D08LMSX*	8	9.0
—	DPR10L71X*	D10LMSX*	10	9.5
—	DPR12L71X*	D12LMSX*	12	9.8
—	DPR15L71X	D15LMSX	15	9.5
—	DPR18L71X	D18LMSX	18	9.5
—	DPR22L71X	D22LMSX	22	10.5
—	DPR28L71X	D28LMSX	28	11.0
—	DPR35L71X	D35LMSX	35	13.5
—	DPR42L71X	D42LMSX	42	13.5
—	DPR14S71X	D14SMSX	14	9.5
—	DPR16S71X	D16SMSX	16	9.5
—	DPR20S71X	D20SMSX	20	12.5
—	DPR25S71X	D25SMSX	25	12.5
—	DPR30S71X	D30SMSX	30	12.5
—	DPR38S71X	D38SMSX	38	13.0

* DPR Progressive Rings in sizes 6, 8, 10 and 12mm are the same for both Series L and S.

Cutting (locking) Rings, Series LL: Zinc plated and clear chromate (CF)

PSR

Progressive Ring
For L and S series only



STANDARD FROM STOCK	d3 Tube O.D. (mm)	L (mm)
TUBE FITTING PART #		
STEEL		
PSR06LX*	6	9.5
PSR08LX*	8	9.5
PSR10LX*	10	10.0
PSR12LX*	12	10.0
PSR15LX	15	10.0
PSR18LX	18	10.0
PSR22LX	22	10.5
PSR28LX	28	10.5
PSR35LX	35	13.0
PSR42LX	42	13.0
PSR14SX	14	10.0
PSR16SX	16	10.0
PSR20SX	20	13.0
PSR25SX	25	13.0
PSR30SX	30	13.0
PSR38SX	38	13.0

* PSR Progressive Rings in sizes 6, 8, 10 and 12mm are the same for both Series L and S.

PSR Progressive Rings: Zinc plated and clear chromated

Dimensions and pressures for reference only, subject to change.

TABLE
OF
CONTENTS

VISUAL
INDEX

E

FM
 EO-2 Dual Function Nut

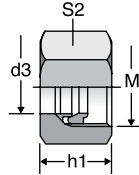


TABLE
 OF
 CONTENTS

VISUAL
 INDEX

TUBE FITTING PART #	SERIES	d3 END SIZE (mm)	M Metric Thread	h1 (mm)	S2 (mm)	STANDARD FROM STOCK				
						CF	SSA	VITCF	VITSSA	71
FM04LL	LL	4	M8 x 1	11.0	10	•	•	•	•	•
FM06LL	very light	6	M10 x 1	11.5	12	•	•	•	•	•
FM06L	L	6	M12 x 1.5	14.5	14	•	•	•	•	•
FM08L	light	8	M14 x 1.5	14.5	17	•	•	•	•	•
FM10L		10	M16 x 1.5	15.5	19	•	•	•	•	•
FM12L		12	M18 x 1.5	15.5	22	•	•	•	•	•
FM15L		15	M22 x 1.5	17.0	27	•	•	•	•	•
FM18L		18	M26 x 1.5	18.0	32	•	•	•	•	•
FM22L		22	M30 x 2	20.0	36	•	•	•	•	•
FM28L		28	M36 x 2	21.0	41	•	•	•	•	•
FM35L		35	M45 x 2	24.0	50	•	•	•	•	•
FM42L		42	M52 x 2	24.0	60	•	•	•	•	•
FM06S	S heavy	6	M14 x 1.5	16.5	17	•	•	•	•	•
FM08S		8	M16 x 1.5	16.5	19	•	•	•	•	•
FM10S		10	M18 x 1.5	17.5	22	•	•	•	•	•
FM12S		12	M20 x 1.5	17.5	24	•	•	•	•	•
FM14S		14	M22 x 1.5	20.5	27	•	•	•	•	•
FM16S		16	M24 x 1.5	20.5	30	•	•	•	•	•
FM20S		20	M30 x 2	24.0	36	•	•	•	•	•
FM25S		25	M36 x 2	27.0	46	•	•	•	•	•
FM30S		30	M42 x 2	29.0	50	•	•	•	•	•
FM38S		38	M52 x 2	32.5	60	•	•	•	•	•

FM Component Breakdown by Material

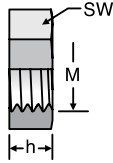
	Nut	Bite Ring	Seal Ring	Elastomer	Nut Finish
CF	Steel	Steel	Steel	NBR	Zinc Clear
SSA	Steel	Stainless Steel	Steel	NBR	Zinc Clear
VITCF	Steel	Steel	Steel	FKM	Zinc Clear
VITSSA	Steel	Stainless Steel	Steel	FKM	Zinc Clear
71	Stainless Steel	Stainless Steel	Stainless Steel	FKM	Passivated

Dimensions and pressures for reference only, subject to change.



GM

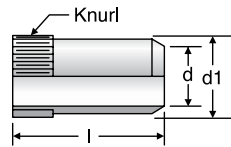
Bulkhead Locknut



TUBE FITTING PART #	FOR USE WITH		h (mm)	M Metric Thread	SW (mm)	STANDARD FROM STOCK		
						CFX	71X	MSX
GM06L	6L		6	M12 x 1.5	17	•		
GM08L	8L	6S	6	M14 x 1.5	19	•		
GM10L	10L	8S	6	M16 x 1.5	22	•		
GM12L	12L	10S	6	M18 x 1.5	24	•	•	
GM12S		12S	6	M20 x 1.5	27	•		
GM15L	15L	14S	7	M22 x 1.5	30	•	•	
GM16S		16S	7	M24 x 1.5	32	•		
GM18L	18L		8	M26 x 1.5	36	•		
GM22L	22L	20S	8	M30 x 2	41	•		
GM28L	28L	25S	9	M36 x 2	46	•		
GM30S		30S	9	M42 x 2	50	•		
GM35L	35L		9	M45 x 2	55	•		
GM42L	42L	38S	10	M52 x 2	65			

VH

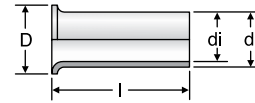
Tube Insert
For Thin Walled Metal Tube



TUBE FITTING PART #	FOR TUBE I.D. Ø (mm)	d (mm)	d1 (mm)	L (mm)	STANDARD FROM STOCK		
					CFX	71X	MSX
VH04	4	2.6	3.8	14	•		•
VH04.5	4.5	3.1	4.3	14			
VH05	5	3.6	4.8	14			
VH06	6	4.6	5.8	14	•		•
VH07	7	5.6	6.8	15.5	•		
VH08	8	6.6	7.8	15.5	•	•	•
VH09	9	7.6	8.8	15.5			•
VH10	10	8.6	9.8	15.5	•	•	•
VH12	12	10.2	11.8	17	•		
VH13	13	11.2	12.8	17		•	•
VH14	14	12.2	13.8	17	•		
VH15	15	13.2	14.8	20	•		
VH16	16	14.2	15.8	20			
VH17	17	15.2	16.8	20	•		
VH18	18	16.2	17.8	20	•		
VH19	19	17.2	18.8	16			•
VH20	20	18.2	19.8	21.5			•
VH21	21	19.2	20.8	21.5			
VH22	22	20.2	21.8	23.5			
VH24	24	22.2	23.8	23.5			
VH25	25	23.2	24.8	23.5			•
VH26	26	24.2	25.8	23.5			
VH27	27	25.2	26.8	23.5			
VH30	30	27.8	29.8	26.5			
VH31	31	28.8	30.8	26.5			•
VH32	32	29.8	31.8	26.5			
VH33	33	30.8	32.8	26.5			
VH38	38	35.8	37.8	21	•		

E

Tube Insert
For Plastic Tube



TUBE FITTING PART #	USE WITH TUBE		d (mm)	D (mm)	di (mm)	L (mm)
	O.D. Ø	I.D. Ø				
	E04/02X	4				
E04/2.5X	4	2.5	2.5	4.0	1.7	8
E0506/03X	5	3.0	3.0	5.0	2.2	14
E0506/03X	6	3.0	3.0	5.0	2.2	14
E0506/04X	5	4.0	4.0	5.0	3.2	14
E0506/04X	6	4.0	4.0	5.0	3.2	14
E08/04X	8	4.0	4.0	6.6	3.2	14
E06/05X	6	5.0	5.0	6.0	4.0	14
E08/05X	8	5.0	5.0	8.0	4.0	14
E10/05X	10	5.0	5.0	8.5	4.0	15
E0810/06X	8	6.0	6.0	8.0	5.0	15
E0810/06X	10	6.0	6.0	8.5	4.0	15
E10/08X	10	8.0	8.0	10.0	6.7	15
E12/08X	12	8.0	8.0	12.0	6.7	15
E12/09X	12	9.0	9.0	12.0	7.7	15
E1215/10X	12	10.0	10.0	12.0	8.7	15
E1215/10X	15	10.0	10.0	12.0	8.7	15
E1215/10X	16	10.0	10.0	12.0	8.7	15
E15/12X	15	12.0	12.0	14.0	10.7	15
E1516/12.5X	15	12.5	12.5	14.8	11.2	15
E1516/12.5X	16	12.5	12.5	14.8	11.2	15
E18/14X	18	14.0	14.0	17.8	12.7	15
E1820/16X	18	16.0	16.0	17.8	14.7	20
E1820/16X	20	16.0	16.0	17.8	14.7	20
E22/18X	22	18.0	18.0	21.8	16.7	16

Note: E inserts are made of brass.

Dimensions and pressures for reference only, subject to change.

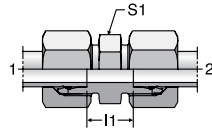
TABLE OF CONTENTS

VISUAL INDEX

E

G

Union
24° Flareless / 24° Flareless



GR

Union Reducer
24° Flareless / 24° Flareless

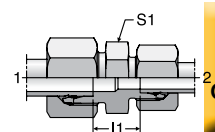


TABLE OF CONTENTS

VISUAL INDEX

TUBE FITTING PART #	END SIZE		I 1 (mm)	S1 (mm)	Pressure Rating (bar)				
	1 (mm)	2 (mm)			EO		EO-2		
					CF	71	MS	CF	71
G04LL	4	4	12	9	100	100	63	100	100
G06LL	6	6	9	11	100	100	63	100	100
G08LL	8	8	12	12	100	100	63	—	—
G10LL	10	10	12	14	100	100	63	—	—
G12LL	12	12	11	17	100	100	63	—	—
G06L	6	6	10	12	500	315	200	500	315
G08L	8	8	11	14	500	315	200	500	315
G10L	10	10	13	17	500	315	200	500	315
G12L	12	12	14	19	400	315	200	400	315
G15L	15	15	16	24	400	315	200	400	315
G18L	18	18	16	27	400	315	200	400	315
G22L	22	22	20	32	250	160	100	250	160
G28L	28	28	21	41	250	160	100	250	160
G35L	35	35	20	46	250	160	100	250	160
G42L	42	42	21	55	250	160	100	250	160
G06S	6	6	16	14	800	630	400	800	630
G08S	8	8	18	17	800	630	400	800	630
G10S	10	10	17	19	800	630	400	800	630
G12S	12	12	19	22	630	630	400	630	630
G14S	14	14	22	24	630	630	400	630	630
G16S	16	16	21	27	630	400	250	630	400
G20S	20	20	23	32	420	400	250	420	400
G25S	25	25	26	41	420	400	250	420	400
G30S	30	30	27	46	420	400	250	420	400
G38S	38	38	29	55	420	315	205	420	315

For EO-2 part number, insert "Z" between size and pressure series. Example: G06ZLCF

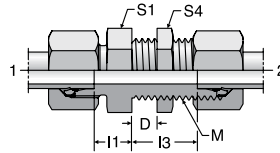
TUBE FITTING PART #	END SIZE		I 1 (mm)	S1 (mm)	Pressure Rating (bar)				
	1 (mm)	2 (mm)			EO		EO-2		
					CF	71	MS	CF	71
GR06/04LL	6	4	10.5	11	100	100	63	100	100
GR08/04LL	8	4	12.5	12	100	100	63	100	100
GR08/06LL	8	6	11.0	12	100	100	63	100	100
GR08/06L	8	6	11.0	14	500	315	200	500	315
GR10/06L	10	6	12.0	17	500	315	200	500	315
GR10/08L	10	8	12.0	17	500	315	200	500	315
GR12/06L	12	6	13.0	19	400	315	200	400	315
GR12/08L	12	8	13.0	19	400	315	200	400	315
GR12/10L	12	10	14.0	19	400	315	200	400	315
GR15/10L	15	10	15.0	24	400	315	200	400	315
GR15/12L	15	12	15.0	24	400	315	200	400	315
GR18/10L	18	10	15.5	27	400	315	200	400	315
GR18/12L	18	12	15.5	27	400	315	200	400	315
GR18/15L	18	15	16.5	27	400	315	200	400	315
GR22/12L	22	12	17.5	32	250	160	100	250	160
GR22/15L	22	15	18.5	32	250	160	100	250	160
GR22/18L	22	18	18.0	32	250	160	100	250	160
GR28/18L	28	18	19.0	41	250	160	100	250	160
GR28/22L	28	22	21.0	41	250	160	100	250	160
GR35/22L	35	22	21.0	46	250	160	100	250	160
GR35/28L	35	28	21.0	46	250	160	100	250	160
GR08/06S	8	6	18.0	17	800	630	400	800	630
GR10/06S	10	6	17.5	19	800	630	400	800	630
GR10/08S	10	8	17.5	19	800	630	400	800	630
GR12/06S	12	6	19.5	22	630	630	400	630	630
GR12/08S	12	8	19.5	22	630	630	400	630	630
GR12/10S	12	10	19.0	22	630	630	400	630	630
GR14/10S	14	10	20.5	24	630	630	400	630	630
GR14/12S	14	12	20.5	24	630	630	400	630	630
GR16/12S	16	12	20.0	27	630	400	250	630	400
GR16/14S	16	14	21.5	27	630	400	250	630	400
GR20/10S	20	10	22.0	32	420	400	250	420	400
GR20/12S	20	12	22.0	32	420	400	250	420	400
GR20/16S	20	16	23.0	32	420	400	250	420	400
GR25/16S	25	16	25.5	41	420	400	250	420	400
GR25/20S	25	20	25.5	41	420	400	250	420	400
GR30/20S	30	20	26.0	46	420	400	250	420	400
GR30/25S	30	25	26.5	46	420	400	250	420	400
GR38/30S	38	30	29.5	55	420	315	200	420	315

For EO-2 part number, insert "Z" between size and pressure series. Example: GR06/04ZLLCF

Dimensions and pressures for reference only, subject to change.

SV

Bulkhead Union
24° Flareless / 24° Flareless



D = 16mm, max. bulkhead thickness

TABLE
OF
CONTENTS

VISUAL
INDEX

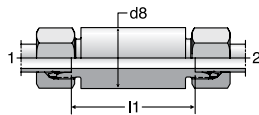
E

TUBE FITTING PART #	END SIZE		M Metric Thread	I 1 (mm)	I 3 (mm)	S1 (mm)	S4 (mm)	Pressure Rating (bar)				
	1 (mm)	2 (mm)						EO			EO-2	
								CF	71	MS	CF	71
SV06L	6	6	M12 x 1.5	7	27.0	17	17	500	315	200	500	315
SV08L	8	8	M14 x 1.5	8	27.0	19	19	500	315	200	500	315
SV10L	10	10	M16 x 1.5	10.0	28.0	22	22	500	315	200	500	315
SV12L	12	12	M18 x 1.5	10.0	29.0	24	24	400	315	200	400	315
SV15L	15	15	M22 x 1.5	12.0	31.0	27	30	400	315	200	400	315
SV18L	18	18	M26 x 1.5	13.5	32.5	32	36	400	315	200	400	315
SV22L	22	22	M30 x 2	16.5	34.5	36	41	250	160	100	250	160
SV28L	28	28	M36 x 2	18.5	35.5	41	46	250	160	100	250	160
SV35L	35	35	M45 x 2	18.5	36.5	50	55	250	160	100	250	160
SV42L	42	42	M52 x 2	19.0	36.0	60	65	250	160	100	250	160
SV06S	6	6	M14 x 1.5	12.0	29.0	19	19	800	630	400	800	630
SV08S	8	8	M16 x 1.5	13.0	29.0	22	22	800	630	400	800	630
SV10S	10	10	M18 x 1.5	14.5	29.5	24	24	800	630	400	800	630
SV12S	12	12	M20 x 1.5	14.5	30.5	27	27	630	630	400	630	630
SV14S	14	14	M22 x 1.5	17.0	32.0	30	30	630	630	400	630	630
SV16S	16	16	M24 x 1.5	16.5	31.5	32	32	630	400	250	630	400
SV20S	20	20	M30 x 2	17.5	33.5	41	41	420	400	250	420	400
SV25S	25	25	M36 x 2	20.0	35.0	46	46	420	400	250	420	400
SV30S	30	30	M42 x 2	21.5	37.5	50	50	420	400	250	420	400
SV38S	38	38	M52 x 2	22.0	37.0	65	65	420	315	205	420	315

For EO-2 part number, insert "Z" between size and pressure series. Example: SV06ZLCF

ESV

Weld Bulkhead Fitting
24° Flareless / 24° Flareless



TUBE FITTING PART #	END SIZE		d8 (mm)	I 1 (mm)	Pressure Rating (bar)			
	1 (mm)	2 (mm)			EO		EO-2	
					CF	71	CF	71
ESV06L	6	6	18	56	500	315	500	315
ESV08L	8	8	20	56	500	315	500	315
ESV10L	10	10	22	58	500	315	500	315
ESV12L	12	12	25	58	400	315	400	315
ESV15L	15	15	28	70	400	315	400	315
ESV18L	18	18	32	69	400	315	400	315
ESV22L	22	22	36	73	250	160	250	160
ESV28L	28	28	40	73	250	160	250	160
ESV35L	35	35	50	71	250	160	250	160
ESV42L	42	42	60	70	250	160	250	160
ESV06S	6	6	20	60	800	630	800	630
ESV08S	8	8	22	60	800	630	800	630
ESV10S	10	10	25	59	800	630	800	630
ESV12S	12	12	28	59	630	630	630	630
ESV14S	14	14	30	72	630	630	630	630
ESV16S	16	16	35	71	630	400	630	400
ESV20S	20	20	38	71	420	400	420	400
ESV25S	25	25	45	72	420	400	420	400
ESV30S	30	30	50	73	420	400	420	400
ESV38S	38	38	60	72	420	315	420	315

For EO-2 part number, insert "Z" between size and pressure series.

Example: ESV06ZL71

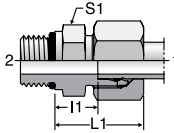
Note: Weld fitting. Omit "CF" in the part number for steel material.

Dimensions and pressures for reference only, subject to change.



GE-UNF/UN

Male Connector
24° Flareless / SAE-ORB



GE-NPT

Male Connector
24° Flareless / NPTF

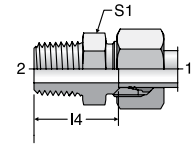


TABLE
OF
CONTENTS

VISUAL
INDEX

TUBE FITTING PART #	END SIZE		I1 (mm)	L1 (mm)	S1 (mm)	Pressure Rating (bar)			
	1 (mm)	2 UN/UNF-2A				EO		EO-2	
						CF	71	CF	71
GE08L7/16UNF	8	7/16-20	10.0	25	17	315	315	315	315
GE10L7/16UNF	10	7/16-20	11.0	26	17	315	315	315	315
GE12L9/16UNF	12	9/16-18	11.0	26	19	315	315	315	315
GE12L3/4UNF	12	3/4-16	13.0	28	24	315	315	315	315
GE12L7/8UNF	12	7/8-14	14.3	29	27	315	315	315	315
GE15L3/4UNF	15	3/4-16	14.0	29	24	315	315	315	315
GE18L3/4UNF	18	3/4-16	14.5	31	27	315	315	315	315
GE18L7/8UNF	18	7/8-14	14.8	31	27	315	315	315	315
GE22L7/8UNF	22	7/8-14	16.8	33	32	160	160	160	160
GE22L11/16UN	22	1 1/16-12	16.5	33	32	160	160	160	160
GE22L15/16UN	22	1 5/16-12	17.5	34	41	160	160	160	160
GE28L11/16UN	28	1 1/16-12	17.5	34	41	160	160	160	160
GE28L15/16UN	28	1 5/16-12	17.5	34	41	160	160	160	160
GE35L15/16UN	35	1 5/16-12	17.5	39	46	160	160	160	160
GE35L15/8UN	35	1 5/8-12	17.5	39	50	160	160	160	160
GE42L15/8UN	42	1 5/8-12	19.0	42	55	160	160	160	160
GE08S7/16UNF	8	7/16-20	13.0	30	17	630	630	630	630
GE10S9/16UNF	10	9/16-18	12.5	31	19	630	630	630	630
GE12S9/16UNF	12	9/16-18	12.5	31	22	630	630	630	630
GE12S3/4UNF	12	3/4-16	14.5	34	24	630	630	630	630
GE16S3/4UNF	16	3/4-16	12.5	34	24	400	400	400	400
GE16S7/8UNF	16	7/8-14	15.5	37	27	400	400	400	400
GE20S3/4UNF	20	3/4-16	17.5	42	32	400	400	400	400
GE20S7/8UNF	20	7/8-14	17.5	42	32	400	400	400	400
GE20S11/16UN	20	1 1/16-12	17.0	42	32	400	400	400	400
GE25S11/16UN	25	1 1/16-12	19.5	47	36	400	400	400	400
GE25S15/16UN	25	1 5/16-12	19.5	47	41	400	400	400	400
GE30S15/16UN	30	1 5/16-12	20.0	50	46	400	400	400	400
GE30S15/8UN	30	1 5/8-12	20.0	50	50	400	400	400	400
GE38S15/8UN	38	1 5/8-12	22.5	57	55	315	315	315	315

For EO-2 part number, insert "Z" between size and pressure series.
Example: GE08ZL7/16UNFCF

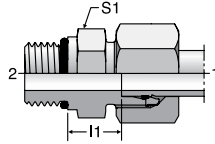
TUBE FITTING PART #	END SIZE		I4 (mm)	S1 (mm)	Pressure Rating (bar)		
	1 (mm)	2 NPT			EO		
					CF	71	MS
GE04LL1/8NPT	4	1/8-27	18.0	11	100	100	63
GE06LL1/8NPT	6	1/8-27	16.5	11	100	100	63
GE08LL1/8NPT	8	1/8-27	18.5	12	100	100	63
GE06L1/8NPT	6	1/8-27	17.0	12	315	315	200
GE06L1/4NPT	6	1/4-18	23.0	17	315	315	200
GE08L1/4NPT	8	1/4-18	23.0	17	315	315	200
GE10L1/4NPT	10	1/4-18	24.0	17	315	315	200
GE10L3/8NPT	10	3/8-18	25.0	19	315	315	200
GE12L1/4NPT	12	1/4-18	25.0	19	315	315	200
GE12L3/8NPT	12	3/8-18	25.0	19	315	315	200
GE12L1/2NPT	12	1/2-14	30.0	22	315	315	200
GE15L1/2NPT	15	1/2-14	31.0	24	315	315	200
GE18L1/2NPT	18	1/2-14	31.5	27	315	315	200
GE22L3/4NPT	22	3/4-14	33.5	32	160	160	100
GE28L1NPT	28	1-11 1/2	39.5	41	160	160	100
GE35L11/4NPT	35	1 1/4-11 1/2	40.5	46	160	160	100
GE42L11/2NPT	42	1 1/2-11 1/2	42.0	55	160	160	100
GE06S1/4NPT	6	1/4-18	28.0	17	630	630	400
GE08S1/4NPT	8	1/4-18	28.0	17	630	630	400
GE10S1/4NPT	10	1/4-18	27.5	19	630	630	400
GE10S3/8NPT	10	3/8-18	27.5	19	630	630	400
GE12S1/4NPT	12	1/4-18	29.5	22	630	630	400
GE12S3/8NPT	12	3/8-18	29.5	22	630	630	400
GE12S1/2NPT	12	1/2-14	34.5	22	630	630	400
GE14S1/2NPT	14	1/2-14	36.0	24	630	630	400
GE16S1/2NPT	16	1/2-14	39.5	32	400	400	250
GE20S3/4NPT	20	3/4-14	37.5	32	400	400	250
GE25S1NPT	25	1-11 1/2	45.0	41	400	400	100
GE30S11/4NPT	30	1 1/4-11 1/2	46.5	46	400	400	100
GE38S11/2NPT	38	1 1/2-11 1/2	49.0	55	315	315	100

Note: Not sold with EO-2 Functional Nut.

Dimensions and pressures for reference only, subject to change.

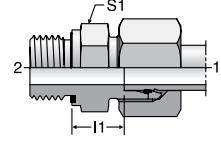
GEO

Male Connector
24° Flareless / ISO 6149



GE-R-ED

Male Connector
24° Flareless / BSPP



DIN 3852-2 Form E

TABLE OF CONTENTS

VISUAL INDEX

E

TUBE FITTING PART #	END SIZE		I 1 (mm)	S1 (mm)	Pressure Rating (bar)			
	1 (mm)	2 Metric Thread			EO		EO-2	
					CF	71	CF	71
GEO04LLM	4	M8 x 1	9.5	11	100	—	100	—
GEO04LLM10x1	4	M10 x 1	9.5	13	100	—	100	—
GEO06LLM	6	M10 x 1	8.0	13	100	—	100	—
GEO06LM	6	M10 x 1	8.5	14	500	315	500	315
GEO08LM	8	M12 x 1.5	10.0	17	500	315	500	315
GEO10LM	10	M14 x 1.5	11.0	19	500	315	500	315
GEO12LM	12	M16 x 1.5	12.5	22	400	315	400	315
GEO15LM	15	M18 x 1.5	13.5	24	400	315	400	315
GEO18LM	18	M22 x 1.5	14.5	27	400	315	400	315
GEO22LM27x2	22	M27 x 2	16.5	32	250	160	250	160
GEO28LM	28	M33 x 2	17.5	41	250	160	250	160
GEO35LM	35	M42 x 2	17.5	50	250	160	250	160
GEO42LM	42	M48 x 2	19.0	55	250	160	250	160
GEO06SM	6	M12 x 1.5	13.0	17	800	630	800	630
GEO08SM	8	M14 x 1.5	15.0	19	800	630	800	630
GEO10SM	10	M16 x 1.5	15.0	22	800	630	800	630
GEO12SM	12	M18 x 1.5	17.0	24	630	630	630	630
GEO16SM	16	M22 x 1.5	18.5	27	630	400	630	400
GEO20SM	20	M27 x 2	20.5	32	420	400	420	400
GEO25SM	25	M33 x 2	23.0	41	420	400	420	400
GEO30SM	30	M42 x 2	23.5	50	420	400	420	400
GEO38SM	38	M48 x 2	26.0	55	420	315	420	315

For EO-2 part number, insert "Z" between size and pressure series.
Example: GEO06ZLMCF

TUBE FITTING PART #	END SIZE		I 1 (mm)	S1 (mm)	Pressure Rating (bar)				
	1 (mm)	2 BSPP			EO		EO-2		
					CF	71	MS	CF	71
GE04LLRED	4	G 1/8 A	9.5	14	100	100	63	100	100
GE06LLRED	6	G 1/8 A	8.0	14	100	100	63	100	100
GE06LRED	6	G 1/8 A	8.5	14	500	315	200	500	315
GE06LR1/4ED	6	G 1/4A	10.0	19	500	315	200	500	315
GE08LR1/8ED	8	G 1/8 A	9.5	14	500	315	200	500	315
GE08LRED	8	G 1/4A	10.0	19	500	315	200	500	315
GE08LR3/8ED	8	G 3/8 A	11.5	22	420	315	200	420	315
GE10LRED	10	G 1/4A	11.0	19	500	315	200	500	315
GE10LR3/8ED	10	G 3/8 A	12.5	22	420	315	200	420	315
GE10LR1/2ED	10	G 1/2 A	13.0	27	400	315	200	400	315
GE12LR1/4ED	12	G 1/4A	12.0	19	400	315	200	400	315
GE12LRED	12	G 3/8 A	12.5	22	420	315	200	420	315
GE12LR1/2ED	12	G 1/2 A	13.0	27	400	315	200	400	315
GE15LR3/8ED	15	G 3/8 A	13.5	24	400	315	200	400	315
GE15LRED	15	G 1/2 A	14.0	27	400	315	200	400	315
GE18LRED	18	G 1/2 A	14.5	27	400	315	200	400	315
GE18LR3/4ED	18	G 3/4 A	14.5	32	250	160	100	250	160
GE22LRED	22	G 3/4 A	16.5	32	250	160	100	250	160
GE28LRED	28	G 1 A	17.5	41	250	160	100	250	160
GE35LRED	35	G 1 1/4A	17.5	50	250	160	100	250	160
GE42LRED	42	G 1 1/2 A	19.0	55	250	160	100	250	160
GE06SRED	6	G 1/4A	13.0	19	800	630	400	800	630
GE08SRED	8	G 1/4A	15.0	19	800	630	400	800	630
GE08SR3/8ED	8	G 3/8 A	15.5	22	800	630	400	800	630
GE10SR1/4ED	10	G 1/4A	14.5	19	800	630	400	800	630
GE10SRED	10	G 3/8 A	15.0	22	800	630	400	800	630
GE10SR1/2ED	10	G 1/2 A	17.5	27	630	630	400	630	630
GE12SR1/4ED	12	G 1/4A	16.5	22	630	630	400	630	630
GE12SRED	12	G 3/8 A	17.0	22	630	630	400	630	630
GE12SR1/2ED	12	G 1/2 A	17.5	27	630	630	400	630	630
GE14SRED	14	G 1/2 A	19.0	27	630	630	400	630	630
GE16SR3/8ED	16	G 3/8 A	18.0	27	630	400	250	630	400
GE16SRED	16	G 1/2 A	18.5	27	630	400	250	630	400
GE16SR3/4ED	16	G 3/4 A	20.5	32	420	400	250	420	400
GE20SRED	20	G 3/4 A	20.5	32	420	400	250	420	400
GE25SR1/2ED	25	G 1/2 A	23.0	41	420	400	250	420	400
GE25SRED	25	G 1 A	23.0	41	420	400	250	420	400
GE30SRED	30	G 1 1/4A	23.5	50	420	400	250	420	400
GE38SRED	38	G 1 1/2 A	26.0	55	420	315	200	420	315

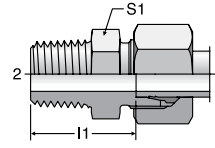
For EO-2 part number, insert "Z" between size and pressure series.
Example: GE06ZLREDCF

Dimensions and pressures for reference only, subject to change.

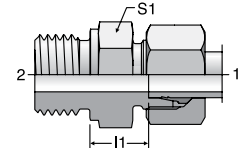


GE-R

Male Connector
24° Flareless / BSPT or BSPP



R (BSPT) thread



Cutting face DIN 3852, form B, G (BSPP) thread

TABLE OF CONTENTS

VISUAL INDEX

TUBE FITTING PART #	END SIZE		I1 (mm)	S1 (mm)	Pressure Rating (bar)		
	1 (mm)	2 BSPT / BSPP			EO		
					CF	71	MS
GE04LLR	4	R 1/8 keg.	16.0	11*	100	100	63
GE06LLR	6	R 1/8 keg.	14.5	11*	100	100	63
GE08LLR	8	R 1/8 keg.	16.5	12	100	100	63
GE08LLR1/4	8	R 1/4 keg.	20.5	14	100	100	63
GE10LLR	10	R 1/4 keg.	20.5	14	100	100	63
GE12LLR	12	R 1/4 keg.	20.0	17	100	100	63
GE12LLR3/8	12	R 3/8 keg.	20.0	17	100	100	63
GE06LR	6	G 1/8 A	8.5	14	315	315	200
GE06LR1/8KEG	6	R 1/8 keg.	15.0	12	315	315	200
GE06LR1/4	6	G 1/4 A	10.0	19	315	315	200
GE06LR3/8	6	G 3/8 A	11.5	22	315	315	200
GE06LR1/2	6	G 1/2 A	12.0	27	315	315	200
GE08LR	8	G 1/4 A	10.0	19	315	315	200
GE08LR1/8	8	G 1/8 A	8.5	14	315	315	200
GE08LR1/4KEG	8	R 1/4 keg.	20.0	17	315	315	200
GE08LR3/8	8	G 3/8 A	11.5	22	315	315	200
GE08LR1/2	8	G 1/2 A	12.0	27	315	315	200
GE10LR	10	G 1/4 A	11.0	19	315	315	200
GE10LR1/4KEG	10	R 1/4 keg.	21.0	17	315	315	200
GE10LR3/8	10	G 3/8 A	12.5	22	315	315	200
GE10LR1/2	10	G 1/2 A	13.0	27	315	315	200
GE12LR	12	G 3/8 A	12.5	22	315	315	200
GE12LR1/4	12	G 1/4 A	12.0	19	315	315	200
GE12LR1/4KEG	12	R 1/4 keg.	22.0	19	315	315	200
GE12LR3/8KEG	12	R 3/8 keg.	22.0	19	315	315	200
GE12LR1/2	12	G 1/2 A	13.0	27	315	315	200
GE12LR1/2KEG	12	R 1/2 keg.	24.0	24	315	315	200
GE12LR3/4	12	G 3/4 A	14.0	32	315	315	200
GE15LR	15	G 1/2 A	14.0	27	250	250	160
GE15LR3/8	15	G 3/8 A	13.5	24	250	250	160
GE15LR3/8KEG	15	R 3/8 keg.	23.0	24	315	315	160
GE15LR1/2KEG	15	R 1/2 keg.	25.0	24	315	315	160
GE15LR3/4	15	G 3/4 A	15.0	32	250	250	160
GE18LR	18	G 1/2 A	14.5	27	250	250	160
GE18LR3/8	18	G 3/8 A	14.0	27	250	250	160
GE18LR1/2KEG	18	R 1/2 keg.	25.5	27	315	315	160
GE18LR3/4	18	G 3/4 A	14.5	32	250	250	160
GE22LR	22	G 3/4 A	16.5	32	160	160	100
GE22LR1/2	22	G 1/2 A	16.5	32	160	160	100
GE22LR3/4KEG	22	R 3/4 keg.	29.5	32	160	160	100
GE28LR	28	G 1 A	17.5	41	160	160	100
GE28LR3/4	28	G 3/4 A	17.5	41	160	160	100
GE35LR	35	G 1 1/4 A	17.5	50	160	160	100
GE35LR1	35	G 1 A	17.5	46	160	160	100
GE42LR	42	G 1 1/2 A	19.0	55	160	160	100

TUBE FITTING PART #	END SIZE		I1 (mm)	S1 (mm)	Pressure Rating (bar)		
	1 (mm)	2 BSPP			EO		
					CF	71	MS
GE06SR	6	G 1/4 A	13.0	19	400	400	250
GE06SR1/2	6	G 1/2 A	18.0	27	400	400	250
GE08SR	8	G 1/4 A	15.0	19	400	400	250
GE08SR3/8	8	G 3/8 A	15.5	22	400	400	250
GE10SR	10	G 3/8 A	15.0	22	400	400	250
GE10SR1/4	10	G 1/4 A	14.5	19	400	400	250
GE10SR1/2	10	G 1/2 A	17.5	27	400	400	250
GE12SR	12	G 3/8 A	17.0	22	400	400	250
GE12SR1/4	12	G 1/4 A	16.5	22	400	400	250
GE12SR1/2	12	G 1/2 A	17.5	27	400	400	250
GE14SR	14	G 1/2 A	19.0	27	400	400	250
GE14SR3/8	14	G 3/8 A	18.5	24	400	400	250
GE16SR	16	G 1/2 A	18.5	27	400	400	250
GE16SR3/8	16	G 3/8 A	18.0	27	400	400	250
GE16SR3/4	16	G 3/4 A	20.5	32	400	400	250
GE20SR	20	G 3/4 A	20.5	32	400	400	250
GE20SR1/2	20	G 1/2 A	20.5	32	400	400	250
GE25SR	25	G 1 A	23.0	41	250	250	160
GE25SR3/4	25	G 3/4 A	23.0	41	250	250	160
GE30SR	30	G 1 1/4 A	23.5	50	160	160	100
GE30SR1	30	G 1 A	23.5	46	160	160	100
GE38SR	38	G 1 1/2 A	26.0	55	160	160	100
GE38SR11/4	38	G 1 1/4 A	26.0	55	160	160	100

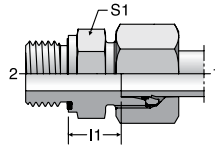
Note: "keg." refers to tapered threads.
Not sold with EO-2 Functional Nut.
*S1 = I2 for stainless steel (71).

Dimensions and pressures for reference only, subject to change.



GE-M-ED

Male Connector
 24° Flareless / Metric with
 EOlastic Seal



DIN 3852-1, form E

TABLE
 OF
 CONTENTS

VISUAL
 INDEX

E

TUBE FITTING PART #	END SIZE		I 1 (mm)	S1 (mm)	Pressure Rating (bar)			
	1 (mm)	2 Metric			EO		EO-2	
					CF	71	CF	71
GE06LMED	6	M10 x 1	8.5	14	500	315	500	315
GE08LMED	8	M12 x 1.5	10.0	17	500	315	500	315
GE10LMED	10	M14 x 1.5	11.0	19	500	315	500	315
GE12LMED	12	M16 x 1.5	12.5	22	400	315	400	315
GE12LM18X1.5ED	12	M18 x 1.5	12.5	24	400	315	400	315
GE12LM22X1.5ED	12	M22 x 1.5	14.0	27	400	315	400	315
GE15LMED	15	M18 x 1.5	13.5	24	400	315	400	315
GE15LM22X1.5ED	15	M22 x 1.5	15.0	27	400	315	400	315
GE18LMED	18	M22 x 1.5	14.5	27	400	315	400	315
GE22LMED	22	M26 x 1.5	16.5	32	250	160	250	160
GE28LMED	28	M33 x 2	17.5	41	250	160	250	160
GE35LMED	35	M42 x 2	17.5	50	250	160	250	160
GE42LMED	42	M48 x 2	19.0	55	250	160	250	160
GE06SMED	6	M12 x 1.5	13.0	17	800	630	800	630
GE08SMED	8	M14 x 1.5	15.0	19	800	630	800	630
GE10SMED	10	M16 x 1.5	15.0	22	800	630	800	630
GE12SMED	12	M18 x 1.5	17.0	24	630	630	630	630
GE14SMED	14	M20 x 1.5	19.0	27	630	630	630	630
GE16SMED	16	M22 x 1.5	18.5	27	630	400	630	400
GE20SMED	20	M27 x 2	20.5	32	420	400	420	400
GE25SMED	25	M33 x 2	23.0	41	420	400	420	400
GE30SMED	30	M42 x 2	23.5	50	420	400	420	400
GE38SMED	38	M48 x 2	26.0	55	420	315	420	315

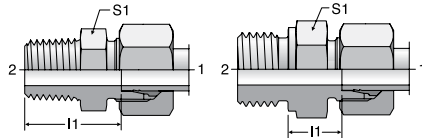
For EO-2 part number, insert "Z" between size and pressure series.
 Example: GE06ZLMEDCF

Dimensions and pressures for reference only, subject to change.



GE-M

Male Connector
24° Flareless / Metric



Metric taper thread

Cutting face DIN 3852, form B, Metric thread

GAI-R

Female Connector
24° Flareless / BSPP

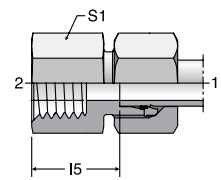


TABLE OF CONTENTS

VISUAL INDEX

TUBE FITTING PART #	END SIZE		I 1 (mm)	S1 (mm)	Pressure Rating (bar)		
	1 (mm)	2 Metric			EO		
					CF	71	MS
GE04LLM6X1KEG	4	M6 x 1 keg.	16.0	9	100	100	63
GE04LLM	4	M8 x 1 keg.	16.0	10	100	100	63
GE06LLM	6	M10 x 1 keg.	14.5	11	100	100	63
GE08LLM	8	M10 x 1 keg.	16.5	12	100	100	63
GE06LM	6	M10 x 1	8.5	14	315	315	200
GE08LM	8	M12 x 1.5	10.0	17	315	315	200
GE10LM	10	M14 x 1.5	11.0	19	315	315	200
GE10LM16X1.5	10	M16 x 1.5	12.0	22	315	315	200
GE10LM18X1.5	10	M18 x 1.5	12.5	24	315	315	200
GE10LM22X1.5	10	M22 x 1.5	14.0	27	315	315	200
GE12LM14X1.5	12	M14 x 1.5	11.0	19	315	315	200
GE12LM	12	M16 x 1.5	12.5	22	315	315	200
GE12LM18X1.5	12	M18 x 1.5	12.5	24	315	315	200
GE12LM22X1.5	12	M22 x 1.5	14.0	27	315	315	200
GE15LM16X1.5	15	M16 x 1.5	13.0	24	250	250	160
GE15LM	15	M18 x 1.5	13.5	24	250	250	160
GE15LM22X1.5	15	M22 x 1.5	15.0	27	250	250	160
GE18LM18X1.5	18	M18 x 1.5	14.0	27	250	250	160
GE18LM	18	M22 x 1.5	14.5	27	250	250	160
GE22LM22X1.5	22	M22 x 1.5	16.5	32	160	160	100
GE22LM	22	M26 x 1.5	16.5	32	160	160	100
GE28LM	28	M33 x 2	17.5	41	160	160	100
GE35LM	35	M42 x 2	17.5	50	160	160	100
GE42LM	42	M48 x 2	19.0	55	160	160	100
GE06SM	6	M12 x 1.5	13.0	17	400	400	250
GE08SM	8	M14 x 1.5	15.0	19	400	400	250
GE10SM	10	M16 x 1.5	15.0	22	400	400	250
GE12SM	12	M18 x 1.5	17.0	24	400	400	250
GE12SM22X1.5	12	M22 x 1.5	17.5	27	400	400	250
GE14SM	14	M20 x 1.5	19.0	27	400	400	250
GE16SM18X1.5	16	M18 x 1.5	18.0	27	400	400	250
GE16SM	16	M22 x 1.5	18.5	27	400	400	250
GE20SM	20	M27 x 2	20.5	32	400	400	250
GE25SM	25	M33 x 2	23.0	41	250	250	160
GE30SM	30	M42 x 2	23.5	50	160	160	100
GE38SM	38	M48 x 2	26.0	55	160	160	100

Note: "keg." refers to taper threads.
Not sold with EO-2 Functional Nut.

TUBE FITTING PART #	END SIZE		I 5 (mm)	S1 (mm)	Pressure Rating (bar)				
	1 (mm)	2 BSPP			EO		EO-2		
					CF	71	MS	CF	71
GAI06LR	6	G 1/8	19.0	14	315	315	200	315	315
GAI08LR	8	G 1/4	24.0	19	315	315	200	315	315
GAI08LR3/8	8	G 3/8	25.0	24	315	315	200	315	315
GAI08LR1/2	8	G 1/2	29.0	27	315	315	200	315	315
GAI10LR	10	G 1/4	25.0	19	315	315	200	315	315
GAI10LR3/8	10	G 3/8	26.0	24	315	315	200	315	315
GAI10LR1/2	10	G 1/2	30.0	27	315	315	200	315	315
GAI12LR	12	G 3/8	26.0	24	315	315	200	315	315
GAI12LR1/2	12	G 1/2	30.0	27	315	315	200	315	315
GAI15LR	15	G 1/2	31.0	27	315	315	200	315	315
GAI18LR	18	G 1/2	30.5	27	315	315	200	315	315
GAI22LR	22	G 3/4	35.5	36	160	160	100	160	160
GAI28LR	28	G 1	38.0	41	160	160	100	160	160
GAI35LR	35	G 1 1/4	41.0	55	160	160	100	160	160
GAI42LR	42	G 1 1/2	42.5	60	160	160	100	160	160
GAI06SR	6	G 1/4	26.0	19	400	400	250	400	400
GAI08SR	8	G 1/4	26.0	19	400	400	250	400	400
GAI10SR	10	G 3/8	26.5	24	400	400	250	400	400
GAI12SR	12	G 3/8	26.5	24	400	400	250	400	400
GAI14SR	14	G 1/2	32.0	30	400	400	250	400	400
GAI16SR	16	G 1/2	31.5	30	400	400	250	400	400
GAI20SR	20	G 3/4	34.5	36	315	315	200	315	315
GAI25SR	25	G 1	37.5	41	315	315	200	315	315
GAI30SR	30	G 1 1/4	42.0	55	315	315	200	315	315
GAI38SR	38	G 1 1/2	43.5	60	250	250	160	250	250

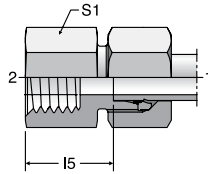
For EO-2 part number, insert "Z" between size and pressure series.
Example: GAI06ZLRFC

Dimensions and pressures for reference only, subject to change.



GAI-M

Female Connector
24° Flareless / Metric



AS

Weld Connector
24° Flareless / Butt Weld

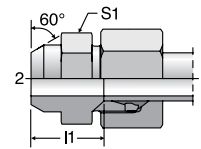


TABLE
OF
CONTENTS

VISUAL
INDEX

E

TUBE FITTING PART #	END SIZE		I 5 (mm)	S1 (mm)	Pressure Rating (bar)			
	1 (mm)	2 Metric			EO		EO-2	
					CF	71	CF	71
GAI06LM	6	M10 x 1	19.5	14	315	315	315	315
GAI08LM	8	M12 x 1.5	24.0	17	315	315	315	315
GAI10LM	10	M14 x 1.5	25.0	19	315	315	315	315
GAI12LM	12	M16 x 1.5	26.0	22	315	315	315	315
GAI15LM	15	M18 x 1.5	28.0	24	315	315	315	315
GAI18LM	18	M22 x 1.5	29.5	30	315	315	315	315
GAI22LM	22	M26 x 1.5	34.5	32	160	160	160	160
GAI28LM	28	M33 x 2	37.5	41	160	160	160	160
GAI35LM	35	M42 x 2	40.5	55	160	160	160	160
GAI42LM	42	M48 x 2	42.0	60	160	160	160	160
GAI06SM	6	M12 x 1.5	26.0	17	400	400	400	400
GAI08SM	8	M14 x 1.5	26.0	17	400	400	400	400
GAI10SM	10	M16 x 1.5	26.5	22	400	400	400	400
GAI12SM	12	M18 x 1.5	27.5	24	400	400	400	400
GAI14SM	14	M20 x 1.5	31.0	27	400	400	400	400
GAI16SM	16	M22 x 1.5	30.5	30	400	400	400	400
GAI20SM	20	M27 x 2	34.5	36	315	315	315	315
GAI25SM	25	M33 x 2	37.0	41	315	315	315	315
GAI30SM	30	M42 x 2	41.5	55	315	315	315	315
GAI38SM	38	M48 x 2	43.0	60	250	250	250	250

TUBE FITTING PART #	END SIZE		I 1 (mm)	S1 (mm)	Pressure Rating (bar)			
	1 (mm)	2 (mm)			EO		EO-2	
					CF	71	CF	71
AS06L	6	10	14.0	12	315	315	315	315
AS08L	8	12	16.0	14	315	315	315	315
AS10L	10	14	18.0	17	315	315	315	315
AS12L	12	16	18.0	19	315	315	315	315
AS15L	15	19	22.0	22	315	315	315	315
AS18L	18	22	23.5	27	315	315	315	315
AS22L	22	27	28.5	32	160	160	160	160
AS28L	28	32	30.5	41	160	160	160	160
AS35L	35	40	32.5	46	160	160	160	160
AS42L	42	46	35.0	55	160	160	160	160
AS06S	6	11	19.0	14	630	630	630	630
AS08S	8	13	21.0	17	630	630	630	630
AS10S	10	15	22.5	19	630	630	630	630
AS12S	12	17	24.5	22	630	630	630	630
AS14S	14	19	27.0	24	630	630	630	630
AS16S	16	21	26.5	27	400	400	400	400
AS20S	20	26	29.5	32	400	400	400	400
AS25S	25	31	32.0	41	400	400	400	400
AS30S	30	36	35.5	46	400	400	400	400
AS38S	38	44	38.0	55	315	315	315	315

For EO-2 part number, insert "Z" between size and pressure series.
Example: GAI06ZLMCF

Note: Weld fitting. Omit "CF" in the part number for steel material.
For EO-2 part number, insert "Z" between size and pressure series.
Example: AS06ZL

Dimensions and pressures for reference only, subject to change.



RED

Tube End Reducer
Flareless Swivel / 24° Flareless

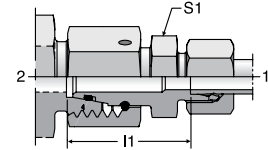


TABLE
OF
CONTENTS

VISUAL
INDEX

L-Series

TUBE FITTING PART #	END SIZE		I1 (mm)	S1 (mm)	Pressure Rating (bar)			
	1 (mm)	2 Metric			EO		EO-2	
					CF	71	CF	71
RED06L/04LL	4	M12 x 1.5	24.5	9	100	100	100	100
RED08/06L	6	M14 x 1.5	23.5	12	500	315	500	315
RED10/06L	6	M16 x 1.5	25	14	500	315	500	315
RED10/08L	8		25	14	500	315	500	315
RED12/06L	6	M18 x 1.5	25	17	400	315	400	315
RED12/08L	8		25	17	400	315	400	315
RED12/10L	10		26	17	400	315	400	315
RED15/06L	6	M22 x 1.5	28.5	19	400	315	400	315
RED15/08L	8		28.5	19	400	315	400	315
RED15/10L	10		29.5	19	400	315	400	315
RED15/12L	12		29.5	19	400	315	400	315
RED18/06L	6	M26 x 1.5	28	24	400	315	400	315
RED18/08L	8		28	24	400	315	400	315
RED18/10L	10		29	24	400	315	400	315
RED18/12L	12		29	24	400	315	400	315
RED18/15L	15		30	24	400	315	400	315
RED22/06L	6	M30 x 2	32	27	250	160	250	160
RED22/08L	8		32	27	250	160	250	160
RED22/10L	10		33	27	250	160	250	160
RED22/12L	12		33	27	250	160	250	160
RED22/15L	15		34	27	250	160	250	160
RED22/18L	18		33.5	27	250	160	250	160
RED28/06L	6	M36 x 2	34	32	250	160	250	160
RED28/08L	8		34	32	250	160	250	160
RED28/10L	10		35	32	250	160	250	160
RED28/12L	12		35	32	250	160	250	160
RED28/15L	15		36	32	250	160	250	160
RED28/18L	18		35.5	32	250	160	250	160
RED28/22L	22		37.5	32	250	160	250	160
RED35/12L	12	M45 x 2	38	41	250	160	250	160
RED35/15L	15		39	41	250	160	250	160
RED35/18L	18		38.5	41	250	160	250	160
RED35/22L	22		40.5	41	250	160	250	160
RED35/28L	28		40.5	41	250	160	250	160
RED42/18L	18	M52 x 2	42	50	250	160	250	160
RED42/22L	22		44	50	250	160	250	160
RED42/28L	28		44	50	250	160	250	160
RED42/35L	35		43	50	250	160	250	160

For EO-2 part number, insert "Z" between size and pressure series.
Example: RED08/06ZLCF

S-Series

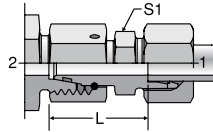
TUBE FITTING PART #	END SIZE		I1 (mm)	S1 (mm)	Pressure Rating (bar)			
	1 (mm)	2 Metric			EO		EO-2	
					CF	71	CF	71
RED08/06S	6	M16 x 1.5	27.0	14	800	630	800	630
RED10/06S	6	M18 x 1.5	27.5	17	800	630	800	630
RED10/08S	8		27.5	17	800	630	800	630
RED12/06S	6	M20 x 1.5	29.0	17	630	630	630	630
RED12/08S	8		29.0	17	630	630	630	630
RED12/10S	10		29.5	19	630	630	630	630
RED14/06S	6	M22 x 1.5	31.5	19	630	630	630	630
RED14/08S	8		31.5	19	630	630	630	630
RED14/10S	10		31.0	19	630	630	630	630
RED14/12S	12		31.0	22	630	630	630	630
RED16/06S	6	M24 x 1.5	32.0	22	630	400	630	400
RED16/08S	8		32.0	22	630	400	630	400
RED16/10S	10		31.5	22	630	400	630	400
RED16/12S	12		31.5	22	630	400	630	400
RED16/14S	14		33.0	24	630	400	630	400
RED20/06S	6	M30 x 2	36.0	27	420	400	420	400
RED20/08S	8		36.0	27	420	400	420	400
RED20/10S	10		35.5	27	420	400	420	400
RED20/12S	12		35.5	27	420	400	420	400
RED20/14S	14		37.0	27	420	400	420	400
RED20/16S	16		36.5	27	420	400	420	400
RED25/06S	6	M36 x 2	38.5	32	420	400	420	400
RED25/08S	8		38.5	32	420	400	420	400
RED25/10S	10		38.0	32	420	400	420	400
RED25/12S	12		38.0	32	420	400	420	400
RED25/14S	14		39.5	32	420	400	420	400
RED25/16S	16		39.0	32	420	400	420	400
RED25/20S	20		39.0	32	420	400	420	400
RED30/08S	8	M42 x 2	44.0	41	420	400	420	400
RED30/10S	10		43.5	41	420	400	420	400
RED30/12S	12		43.5	41	420	400	420	400
RED30/14S	14		45.0	41	420	400	420	400
RED30/16S	16		44.5	41	420	400	420	400
RED30/20S	20		44.5	41	420	400	420	400
RED30/25S	25		45.0	41	420	400	420	400
RED38/12S	12	M52 x 2	47.0	50	420	315	420	315
RED38/16S	16		48.0	50	420	315	420	315
RED38/20S	20		48.0	50	420	315	420	315
RED38/25S	25		48.5	50	420	315	420	315
RED38/30S	30		49.0	50	420	315	420	315

For EO-2 part number, insert "Z" between size and pressure series.
Example: RED08/06ZSCF

Dimensions and pressures for reference only, subject to change.

DA

Distance Piece Adapter
Flareless Swivel / 24° Flareless

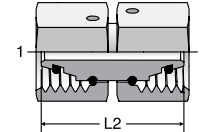


TUBE FITTING PART #	END SIZE		L (mm)	S1 (mm)	Pressure Rating (bar)				
	1 (mm)	2 Metric			EO		EO-2		
					CF	71	MS	CF	71
DA06L	6	M12 x 1.5	36	12	500	315	200	500	315
DA08L	8	M14 x 1.5	36	14	500	315	200	500	315
DA10L	10	M16 x 1.5	36	17	500	315	200	500	315
DA12L	12	M18 x 1.5	36	19	400	315	200	400	315
DA15L	15	M22 x 1.5	36	24	400	315	200	400	315
DA18L	18	M26 x 1.5	36	27	400	315	200	400	315
DA22L	22	M30 x 2	40	32	250	160	100	250	160
DA28L	28	M36 x 2	40	41	250	160	100	250	160
DA35L	35	M45 x 2	50	46	250	160	100	250	160
DA42L	42	M52 x 2	60	55	250	160	100	250	160
DA06S	6	M14 x 1.5	36	14	800	630	400	800	630
DA08S	8	M16 x 1.5	36	17	800	630	400	800	630
DA10S	10	M18 x 1.5	36	19	800	630	400	800	630
DA12S	12	M20 x 1.5	36	22	630	630	400	630	630
DA14S	14	M22 x 1.5	40	24	630	630	400	630	630
DA16S	16	M24 x 1.5	40	27	630	400	250	630	400
DA20S	20	M30 x 2	46	32	420	400	250	420	400
DA25S	25	M36 x 2	50	41	420	400	250	420	400
DA30S	30	M42 x 2	56	46	420	400	250	420	400
DA38S	38	M52 x 2	60	55	420	315	200	420	315

For EO-2 part number, insert "Z" between size and pressure series.
Example: DA06ZLCF

GZ

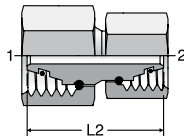
Swivel Union
Flareless Swivel / Flareless Swivel



TUBE FITTING PART #	END SIZE 1 & 2 Metric	L2 (mm)	Pressure Rating (bar)	
			EO	
			CF	71
GZ06L	M12 x 1.5	32	500	315
GZ08L	M14 x 1.5	32	500	315
GZ10L	M16 x 1.5	33	500	315
GZ12L	M18 x 1.5	33	400	315
GZ15L	M22 x 1.5	38	400	315
GZ18L	M26 x 1.5	38	400	315
GZ22L	M30 x 2	44	250	160
GZ28L	M36 x 2	48	250	160
GZ35L	M45 x 2	52	250	160
GZ42L	M52 x 2	57	250	160
GZ06S	M14 x 1.5	33	800	630
GZ08S	M16 x 1.5	34	800	630
GZ10S	M18 x 1.5	35	800	630
GZ12S	M20 x 1.5	38	630	630
GZ14S	M22 x 1.5	41	630	630
GZ16S	M24 x 1.5	42	630	400
GZ20S	M30 x 2	48	420	400
GZ25S	M36 x 2	53	420	400
GZ30S	M42 x 2	62	420	400
GZ38S	M52 x 2	67	420	315

GZR

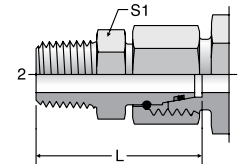
Swivel Union Reducer
Flareless Swivel / Flareless Swivel



TUBE FITTING PART #	END SIZE		L2 (mm)	Pressure Rating (bar)	
	1 Metric	2 Metric		EO	
				CF	71
GZR06L/06S	M14 x 1.5	M12 x 1.5	32.0	500	500
GZR08L/08S	M16 x 1.5	M14 x 1.5	33.0	500	500
GZR10L/10S	M18 x 1.5	M16 x 1.5	33.5	500	500
GZR12L/12S	M20 x 1.5	M18 x 1.5	36.0	400	400
GZR12L/08L	M18 x 1.5	M14 x 1.5	34.0	400	400
GZR15/08L	M22 x 1.5	M14 x 1.5	38.0	400	400
GZR15/12L	M22 x 1.5	M18 x 1.5	38.0	400	400
GZR18L/16S	M26 x 1.5	M24 x 1.5	41.5	400	400
GZR22L/20S	M30 x 2	M30 x 2	47.0	250	250
GZR28L/25S	M36 x 2	M36 x 2	50.5	250	250
GZR28/22L	M36 x 2	M30 x 2	46.0	250	250
GZR35L/30S	M45 x 2	M42 x 2	59.0	250	250
GZR42L/38S	M52 x 2	M52 x 2	62.0	250	250
GZR16S/15L	M24 x 1.5	M22 x 1.5	41.0	400	400
GZR20S/18L	M30 x 2	M26 x 1.5	37.5	400	400
GZR25S/22L	M36 x 2	M30 x 2	46	250	250
GZR30S/28L	M42 x 2	M36 x 2	52	250	250
GZR38S/35L	M52 x 2	M45 x 2	52	250	250

EGE-NPT

Swivel Connector
Flareless Swivel / NPT

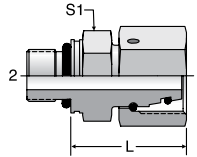


TUBE FITTING PART #	END SIZE		L (mm)	S1 (mm)	Pressure Rating (bar)	
	1 Metric	2 NPT			EO	
					CF	71
EGE06L1/8NPT	M12 x 1.5	1/8-27	31.5	11	315	315
EGE08L1/4NPT	M14 x 1.5	1/4-18	37.5	14	315	315
EGE10L1/4NPT	M16 x 1.5	1/4-18	38.0	14	315	315
EGE12L3/8NPT	M18 x 1.5	3/8-18	40.0	19	315	315
EGE15L1/2NPT	M22 x 1.5	1/2-14	49.5	22	315	315
EGE18L1/2NPT	M26 x 1.5	1/2-14	49.0	24	315	315
EGE22L3/4NPT	M30 x 2	3/4-14	52.0	27	160	160
EGE28L1NPT	M36 x 2	1-11 1/2	61.0	36	160	160
EGE35L11/4NPT	M45 x 2	1 1/4-11 1/2	65.5	46	160	160
EGE42L11/2NPT	M52 x 2	1 1/2-11 1/2	68.5	50	160	160
EGE06S1/4NPT	M14 x 1.5	1/4-18	37.5	14	630	630
EGE08S1/4NPT	M16 x 1.5	1/4-18	38.0	14	630	630
EGE10S3/8NPT	M18 x 1.5	3/8-18	40.5	19	630	630
EGE12S3/8NPT	M20 x 1.5	3/8-18	42.0	19	630	630
EGE14S1/2NPT	M22 x 1.5	1/2-14	50.5	22	630	630
EGE16S1/2NPT	M24 x 1.5	1/2-14	51.0	22	400	400
EGE20S3/4NPT	M30 x 2	3/4-14	54.0	27	400	400
EGE25S1NPT	M36 x 2	1-11 1/2	63.5	36	400	400
EGE30S11/4NPT	M42 x 2	1 1/4-11 1/2	70.5	46	400	400
EGE38S11/2NPT	M52 x 2	1 1/2-11 1/2	73.5	50	315	315

Dimensions and pressures for reference only, subject to change.

EGEO

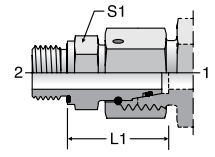
Swivel Connector
Metric ISO 6149 / Flareless Swivel



TUBE FITTING PART #	END SIZE		L (mm)	S1 (mm)	Pressure Rating (bar)	
	1	2			EO	
	Metric	Metric			CF	71
EGEO06LM	M12 x 1.5	M10 x 1	24.5	14	500	315
EGEO08LM	M14 x 1.5	M12 x 1.5	26.5	17	500	315
EGEO10LM	M16 x 1.5	M14 x 1.5	27.5	19	500	315
EGEO12LM	M18 x 1.5	M16 x 1.5	30.5	22	400	315
EGEO15LM	M22 x 1.5	M18 x 1.5	31.5	24	400	315
EGEO18LM	M26 x 1.5	M22 x 1.5	31.5	27	400	315
EGEO22LM27X2	M30 x 2	M27 x 2	32.5	32	250	160
EGEO28LM	M36 x 2	M33 x 2	35.0	41	250	160
EGEO35LM	M45 x 2	M42 x 2	42.5	50	250	160
EGEO08SM	M16 x 1.5	M14 x 1.5	29.5	19	800	630
EGEO10SM	M18 x 1.5	M16 x 1.5	32.0	22	800	630
EGEO12SM	M20 x 1.5	M18 x 1.5	34.0	24	630	630
EGEO16SM	M24 x 1.5	M22 x 1.5	37.0	27	630	400
EGEO20SM	M30 x 2	M27 x 2	43.0	32	420	400
EGEO25SM	M36 x 2	M33 x 2	48.0	41	420	400
EGEO30SM	M42 x 2	M42 x 2	51.0	50	420	400

EGE-R-ED

Swivel Connector
Flareless Swivel / BSPP with EOlastic Seal



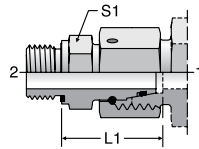
TUBE FITTING PART #	END SIZE		L1 (mm)	S1 (mm)	Pressure Rating (bar)	
	1	2			EO	
	Metric	BSPP			CF	71
EGEO6LRED	M12 x 1.5	G 1/8A	24.5	14	500	315
EGEO8LRED	M14 x 1.5	G 1/4A	29.5	19	500	315
EGEO10LRED	M16 x 1.5	G 1/4A	27.5	19	500	315
EGEO12LRED	M18 x 1.5	G 3/8A	34.0	22	400	315
EGEO15LRED	M22 x 1.5	G 1/2A	32.0	27	400	315
EGEO18LRED	M26 x 1.5	G 1/2A	31.5	27	400	315
EGEO22LRED	M30 x 2	G 3/4A	32.5	32	250	160
EGEO28LRED	M36 x 2	G 1A	35.0	41	250	160
EGEO35LRED	M45 x 2	G 1 1/4A	42.5	50	250	160
EGEO42LRED	M52 x 2	G 1 1/2A	46.5	55	250	160
EGEO6SRED	M14 x 1.5	G 1/4A	27.0	19	800	630
EGEO8SRED	M16 x 1.5	G 1/4A	29.5	19	800	630
EGEO10SRED	M18 x 1.5	G 3/8A	32.0	22	800	630
EGEO12SRED	M20 x 1.5	G 3/8A	34.0	22	630	630
EGEO14SRED	M22 x 1.5	G 1/2A	36.5	27	630	630
EGEO16SRED	M24 x 1.5	G 1/2A	37.0	27	630	400
EGEO20SRED	M30 x 2	G 3/4A	43.0	32	420	400
EGEO25SRED	M36 x 2	G 1A	48.0	41	420	400
EGEO30SRED	M42 x 2	G 1 1/4A	51.0	50	420	400
EGEO38SRED	M52 x 2	G 1 1/2A	60.0	55	420	315

TABLE OF CONTENTS

VISUAL INDEX

EGE-M-ED

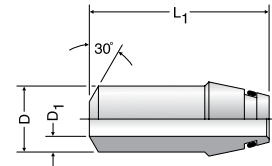
Swivel Connector
Flareless Swivel / Metric with EOlastic Seal



TUBE FITTING PART #	END SIZE		L1 (mm)	S1 (mm)	Pressure Rating (bar)	
	1	2			EO	
	Metric	Metric			CF	71
EGEO6LMED	M12 x 1.5	M10 x 1	24.5	14	500	315
EGEO8LMED	M14 x 1.5	M12 x 1.5	26.5	17	500	315
EGEO10LMED	M16 x 1.5	M14 x 1.5	27.5	19	500	315
EGEO12LMED	M18 x 1.5	M16 x 1.5	30.5	22	400	315
EGEO15LMED	M22 x 1.5	M18 x 1.5	31.5	24	400	315
EGEO18LMED	M26 x 1.5	M22 x 1.5	31.5	27	400	315
EGEO22LMED	M30 x 2	M26 x 1.5	32.5	32	250	160
EGEO28LMED	M36 x 2	M33 x 2	35.0	41	250	160
EGEO35LMED	M45 x 2	M42 x 2	42.5	50	250	160
EGEO42LMED	M52 x 2	M48 x 2	46.5	55	250	160
EGEO6SMED	M14 x 1.5	M12 x 1.5	27.0	17	800	630
EGEO8SMED	M16 x 1.5	M14 x 1.5	29.5	19	800	630
EGEO10SMED	M18 x 1.5	M16 x 1.5	32.0	22	800	630
EGEO12SMED	M20 x 1.5	M18 x 1.5	34.0	24	630	630
EGEO14SMED	M22 x 1.5	M20 x 1.5	36.5	27	630	630
EGEO16SMED	M24 x 1.5	M22 x 1.5	37.0	27	630	400
EGEO20SMED	M30 x 2	M27 x 2	43.0	32	420	400
EGEO25SMED	M36 x 2	M33 x 2	48.0	41	420	400
EGEO30SMED	M42 x 2	M42 x 2	51.0	50	420	400
EGEO38SMED	M52 x 2	M48 x 2	60.0	55	420	315

SKA

Weld Nipple
24° Flareless / ISO 8434-4 Butt Weld



TUBE FITTING PART #	D (mm)	D1 (mm)	L1 (mm)	Pressure Rating (bar)	
				EO	
				CF	71
SKA10X1	10	8	32.5	249	240
SKA10X1.5	10	7	32.5	358	350
SKA10X2	10	6	32.5	460	445
SKA12X1.5	12	9	32.5	305	300
SKA12X2	12	8	32.5	393	380
SKA12X2.5	12	7	32.5	476	460
SKA16X1.5	16	13	39.0	234	225
SKA16X2	16	12	39.0	305	295
SKA16X2.5	16	11	39.0	372	360
SKA16X3	16	10	39.0	400	390
SKA20X2	20	16	45.0	249	240
SKA20X2.5	20	15	45.0	305	300
SKA20X3	20	14	45.0	358	350
SKA20X4	20	12	45.0	400	390
SKA25X3	25	19	49.5	294	285
SKA25X4	25	17	49.5	379	365
SKA25X5	25	15	49.5	400	390
SKA30X3	30	24	52.0	249	240
SKA30X4	30	22	52.0	323	314
SKA30X5	30	20	52.0	393	380
SKA30X6	30	18	52.0	400	390
SKA38X4	38	30	56.5	261	254
SKA38X5	38	28	56.5	315	315
SKA38X6	38	26	56.5	315	315
SKA38X7	38	24	56.5	315	315

Note: Weld fitting. Omit "CF" in the part number for steel material. Part does not include the tube nut. Size 10 and 12 SKA will work for Series L & S

Dimensions and pressures for reference only, subject to change.

VEE-UNF

Adjustable Locknut 45° Elbow
24° Flareless / SAE-ORB

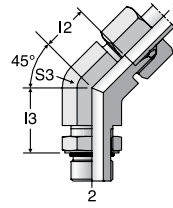


TABLE
OF
CONTENTS

VISUAL
INDEX

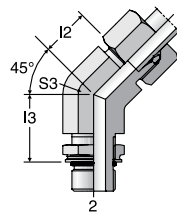
E

TUBE FITTING PART #	END SIZE		I 2 (mm)	I 3 (mm)	S3 (mm)	Pressure Rating (bar)			
	1 (mm)	2 UN/UNF-2A				EO		EO-2	
						CF	71	CF	71
VEE06L7/16UNF	6	7/16-20	9	19	14	315	315	315	315
VEE08L7/16UNF	8	7/16-20	12	19	14	315	315	315	315
VEE10L7/16UNF	10	9/16-18	12	24	19	315	315	315	315
VEE12L9/16UNF	12	9/16-18	14	24	19	315	315	315	315
VEE12L3/4UNF	12	3/4-16	14	24	19	315	315	315	315
VEE15L3/4UNF	15	3/4-16	17	24	22	315	315	315	315
VEE15L7/8UNF	15	7/8-14	17	24	22	315	315	315	315
VEE18L7/8UNF	18	7/8-14	17	30	27	315	315	315	315
VEE18L11/16UN	18	1 1/16-12	17	30	30	315	315	315	315
VEE22L11/16UN	22	1 1/16-12	19	33	30	160	160	160	160
VEE28L15/16UN	28	1 5/16-12	23	35	36	160	160	160	160
VEE35L15/8UN	35	1 5/8-12	27	37	50	160	160	160	160
VEE42L17/8UN	42	1 7/8-12	26	37	50	160	160	160	160
VEE06S7/16UNF	6	7/16-20	9	18	14	400	400	400	400
VEE08S9/16UNF	8	9/16-18	12	21	19	400	400	400	400
VEE10S9/16UNF	10	9/16-18	13	21	19	400	400	400	400
VEE12S3/4UNF	12	3/4-16	17	22	22	400	400	400	400
VEE16S7/8UNF	16	7/8-14	16	29	27	400	400	400	400
VEE20S11/16UN	20	1 1/16-12	16	31	30	400	400	400	400
VEE25S11/16UN	25	1 1/16-12	30	33	36	400	400	400	400
VEE30S15/8UN	30	1 5/8-12	24	35	50	250	250	250	250
VEE38S17/8UN	38	1 7/8-12	21	35	50	250	250	250	250

For EO-2 part number, insert "Z" between size and pressure series.
Example: VEE06ZL7/16UNFCF

VEE-OR

Adjustable Locknut 45° Elbow
24° Flareless / Metric ISO 6149



TUBE FITTING PART #	END SIZE		I 2 (mm)	I 3 (mm)	S3 (mm)	Pressure Rating (bar)			
	1 (mm)	2 Metric				EO		EO-2	
						CF	71	CF	71
VEE06LMOR	6	M10 x 1	9	20	14	315	315	315	315
VEE08LMOR	8	M12 x 1.5	12	18	14	315	315	315	315
VEE10LMOR	10	M14 x 1.5	12	22	19	315	315	315	315
VEE12LMOR	12	M16 x 1.5	14	23	19	315	315	315	315
VEE15LMOR	15	M18 x 1.5	17	23	22	315	315	315	315
VEE18LMOR	18	M22 x 1.5	17	30	27	315	315	315	315
VEE22LM27X2OR	22	M27 x 2	19	30	30	160	160	160	160
VEE28LMOR	28	M33 x 2	23	34	36	160	160	160	160
VEE35LMOR	35	M42 x 2	27	36	50	160	160	160	160
VEE42LMOR	42	M48 x 2	26	36	50	160	160	160	160
VEE06SMOR	6	M12 x 1.5	9	18	14	400	400	400	400
VEE08SMOR	8	M14 x 1.5	12	18	19	400	400	400	400
VEE10SMOR	10	M16 x 1.5	13	22	19	400	400	400	400
VEE12SMOR	12	M18 x 1.5	17	23	22	400	400	400	400
VEE16SMOR	16	M22 x 1.5	16	20	27	400	400	400	400
VEE20SMOR	20	M27 x 2	16	33	30	400	400	400	400
VEE25SMOR	25	M33 x 2	19	35	36	315	315	315	315
VEE30SMOR	30	M42 x 2	24	36	50	250	250	250	250
VEE38SMOR	38	M48 x 2	21	36	50	200	200	200	200

For EO-2 part number, insert "Z" between size and pressure series.
Example: VEE06ZLMORCF

Dimensions and pressures for reference only, subject to change.



VEE-R

Adjustable Locknut 45° Elbow
24° Flareless / BSPP ORR

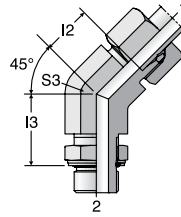


TABLE
OF
CONTENTS

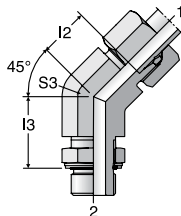
VISUAL
INDEX

TUBE FITTING PART #	END SIZE		I 2 (mm)	I 3 (mm)	S 3 (mm)	Pressure Rating (bar)			
	1 (mm)	2 BSPP				EO		EO-2	
						CF	71	CF	71
VEE06LR	6	G 1/8A	9	21	14	315	315	315	315
VEE08LR	8	G 1/4A	12	20	14	315	315	315	315
VEE10LR	10	G 1/4A	12	25	19	315	315	315	315
VEE12LR	12	G 3/8A	14	28	19	250	250	250	250
VEE15LR	15	G 1/2A	17	26	22	250	250	250	250
VEE18LR	18	G 1/2A	17	32	27	250	250	250	250
VEE22LR	22	G 3/4A	19	37	30	160	160	160	160
VEE28LR	28	G 1A	23	37	36	160	160	160	160
VEE35LR	35	G 1 1/4A	27	39	50	160	160	160	160
VEE42LR	42	G 1 1/2A	26	39	50	160	160	160	160
VEE06SR	6	G 1/4A	9	19	14	315	315	315	315
VEE08SR	8	G 1/4A	12	23	19	315	315	315	315
VEE10SR	10	G 3/8A	13	25	19	250	250	250	250
VEE12SR	12	G 3/8A	17	25	22	250	250	250	250
VEE16SR	16	G 1/2A	16	31	27	250	250	250	250
VEE20SR	20	G 3/4A	16	34	30	250	250	250	250
VEE25SR	25	G 1A	19	37	36	250	250	250	250
VEE30SR	30	G 1 1/4A	24	38	50	160	160	160	160
VEE38SR	38	G 1 1/2A	21	38	50	160	160	160	160

For EO-2 part number, insert "Z" between size and pressure series.
Example: VEE06ZLRFCF

VEE-M

Adjustable Locknut 45° Elbow
24° Flareless / Metric ORR



TUBE FITTING PART #	END SIZE		I 2 (mm)	I 3 (mm)	S 3 (mm)	Pressure Rating (bar)			
	1 (mm)	2 Metric				EO		EO-2	
						CF	71	CF	71
VEE06LM	6	M10 x 1	9	21	14	315	315	315	315
VEE08LM	8	M12 x 1.5	12	19	14	315	315	315	315
VEE10LM	10	M14 x 1.5	12	24	19	315	315	315	315
VEE12LM	12	M16 x 1.5	14	25	19	315	315	315	315
VEE15LM	15	M18 x 1.5	17	24	22	315	315	315	315
VEE18LM	18	M22 x 1.5	17	31	27	250	250	250	250
VEE22LM27X2	22	M27 x 2	19	31	30	160	160	160	160
VEE28LM	28	M33 x 2	23	35	36	160	160	160	160
VEE35LM	35	M42 x 2	27	37	50	160	160	160	160
VEE42LM	42	M48 x 2	26	37	50	160	160	160	160
VEE06SM	6	M12 x 1.5	9	19	14	315	315	315	315
VEE08SM	8	M14 x 1.5	12	19	19	315	315	315	315
VEE10SM	10	M16 x 1.5	13	23	19	315	315	315	315
VEE12SM	12	M18 x 1.5	17	25	22	315	315	315	315
VEE16SM	16	M22 x 1.5	16	30	27	250	250	250	250
VEE20SM	20	M27 x 2	16	35	30	250	250	250	250
VEE25SM	25	M33 x 2	19	37	36	160	160	160	160
VEE30SM	30	M42 x 2	24	37	50	160	160	160	160
VEE38SM	38	M48 x 2	21	38	50	160	160	160	160

For EO-2 part number, insert "Z" between size and pressure series.
Example: VEE06ZLMCF

Dimensions and pressures for reference only, subject to change.

W

Elbow Union 24° Flareless / 24° Flareless

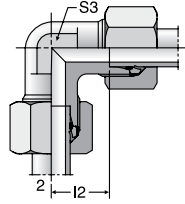


TABLE
OF
CONTENTS

VISUAL
INDEX

E

TUBE FITTING PART #	END SIZE			S3 (Stainless Steel) (mm)	Pressure Rating (bar)				
	1 & 2 (mm)	12 (mm)	S3 (mm)		EO			EO-2	
					CF	71	MS	CF	71
*W04LL	4	11	9	9	100	100	63	100	100
*W06LL	6	9.5	11	9	100	100	63	100	100
*W08LL	8	11.5	12	12	100	100	63	100	100
*W10LL	10	12.5	14	12	100	100	63	100	100
*W12LL	12	13	17	14	100	100	63	100	100
*W06L	6	12	12	12	500	315	200	500	315
*W08L	8	14	14	12	500	315	200	500	315
*W10L	10	15	17	14	500	315	200	500	315
*W12L	12	17	19	19	400	315	200	400	315
W15L	15	21	19	19	400	315	200	400	315
W18L	18	23.5	24	24	400	315	200	400	315
W22L	22	27.5	27	27	250	160	100	250	160
W28L	28	30.5	36	36	250	160	100	250	160
W35L	35	34.5	41	41	250	160	100	250	160
W42L	42	40	50	50	250	160	100	250	160
*W06S	6	16	14	12	800	630	400	800	630
*W08S	8	17	17	14	800	630	400	800	630
*W10S	10	17.5	19	17	500	630	400	500	630
*W12S	12	21.5	22	17	630	630	400	630	630
W14S	14	22	19	19	630	630	400	630	630
W16S	16	24.5	24	24	630	400	250	630	400
W20S	20	26.5	27	27	420	400	250	420	400
W25S	25	30	36	36	420	400	250	420	400
W30S	30	35.5	41	41	420	400	250	420	400
W38S	38	41	50	50	420	315	200	420	315

* Extruded body for steel and brass.
For EO-2 part number, insert "Z" between size and pressure series.
Example: W04ZLLCF

Dimensions and pressures for reference only, subject to change.



WSV

Bulkhead Union Elbow
24° Flareless / 24° Flareless

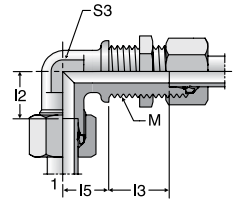


TABLE OF CONTENTS

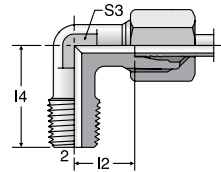
VISUAL INDEX

TUBE FITTING PART #	END SIZE 1 & 2 (mm)	M Metric	I 2 (mm)	I 3 (mm)	I 5 (mm)	S3 (mm)	Pressure Rating (bar)				
							EO			EO-2	
							CF	71	MS	CF	71
WSV06L	6	M12 x 1.5	12.0	27.0	14	12	315	315	200	315	315
WSV08L	8	M14 x 1.5	14.0	27.0	17	12	315	315	200	315	315
WSV10L	10	M16 x 1.5	15.0	28.0	18	14	315	315	200	315	315
WSV12L	12	M18 x 1.5	17.0	29.0	20	17	315	315	200	315	315
WSV15L	15	M22 x 1.5	21.0	31.0	23	19	315	315	200	315	315
WSV18L	18	M26 x 1.5	23.5	32.5	24	24	315	315	200	315	315
WSV22L	22	M30 x 2	27.5	34.5	30	27	160	160	100	160	160
WSV28L	28	M36 x 2	30.5	35.5	34	36	160	160	100	160	160
WSV35L	35	M45 x 2	34.5	36.5	39	41	160	160	100	160	160
WSV42L	42	M52 x 2	40.0	36.0	43	50	160	160	100	160	160
WSV06S	6	M14 x 1.5	16.0	29.0	17	12	630	630	400	630	630
WSV08S	8	M16 x 1.5	17.0	29.0	18	14	630	630	400	630	630
WSV10S	10	M18 x 1.5	17.5	29.5	20	17	630	630	400	630	630
WSV12S	12	M20 x 1.5	21.5	30.5	21	17	630	630	400	630	630
WSV14S	14	M22 x 1.5	22.0	32.0	23	19	630	630	400	630	630
WSV16S	16	M24 x 1.5	24.5	31.5	24	24	400	400	250	400	400
WSV20S	20	M30 x 2	26.5	33.5	30	27	400	400	250	400	400
WSV25S	25	M36 x 2	30.0	35.0	34	36	400	400	250	400	400
WSV30S	30	M42 x 2	35.5	37.5	39	41	400	400	250	400	400
WSV38S	38	M52 x 2	41.0	37.0	43	50	315	315	200	315	315

For EO-2 part number, insert "Z" between size and pressure series.
Example: WSV06ZLCF

WE-NPT

Male Elbow
24° Flareless / NPT



TUBE FITTING PART #	END SIZE		I 2 (mm)	I 4 (mm)	S3 (mm)	S3 Stainless Steel (mm)	Pressure Rating (bar)		
	1 (mm)	2 NPT					EO		
							CF	71	MS
* WE04LL1/8NPT	4	1/8-27	11.0	17	11	9	100	100	65
* WE06LL1/8NPT	6	1/8-27	9.5	17	11	9	100	100	65
* WE08LL1/8NPT	8	1/8-27	11.5	20	12	12	100	100	65
* WE06L1/8NPT	6	1/8-27	12.0	20	12	12	315	315	200
* WE06L1/4NPT	6	1/4-18	14.0	26	14	12	315	315	200
* WE08L1/4NPT	8	1/4-18	14.0	26	14	12	315	315	200
* WE10L1/4NPT	10	1/4-18	15.0	27	17	14	315	315	200
* WE12L3/8NPT	12	3/8-18	17.0	28	19	17	315	315	200
* WE12L1/4NPT	12	1/4-18	17.0	28	19	17	315	315	200
WE12L1/2NPT	12	1/2-14	21.0	34	19	19	315	315	200
WE15L1/2NPT	15	1/2-14	21.0	34	19	19	315	315	200
WE18L1/2NPT	18	1/2-14	23.5	36	24	24	315	315	200
WE22L3/4NPT	22	3/4-14	27.5	42	27	27	160	160	100
WE28L1NPT	28	1-11 1/2	30.5	48	36	36	160	160	100
WE35L11/4NPT	35	1 1/4-11 1/2	34.5	54	41	41	160	160	100
WE42L11/2NPT	42	1 1/2-11 1/2	40.0	61	50	50	160	160	100
* WE06S1/4NPT	6	1/4-18	16.0	26	14	12	630	630	400
* WE08S1/4NPT	8	1/4-18	17.0	27	17	14	630	630	400
* WE10S3/8NPT	10	3/8-18	17.5	28	19	17	630	630	400
* WE12S3/8NPT	12	3/8-18	22.5	28	22	17	630	630	400
WE14S1/2NPT	14	1/2-14	22.0	34	19	19	630	630	400
WE16S1/2NPT	16	1/2-14	24.5	36	24	24	400	400	250
WE20S3/4NPT	20	3/4-14	26.5	42	27	27	400	400	250
WE25S1NPT	25	1-11 1/2	30.0	48	36	36	400	400	250
WE30S11/4NPT	30	1 1/4-11 1/2	35.5	54	41	41	400	400	250
WE38S11/2NPT	38	1 1/2-11 1/2	41.0	61	50	50	315	315	200

* Extruded body for steel and brass.

Dimensions and pressures for reference only, subject to change.



WE-R keg

Male Elbow
24° Flareless / BSPT

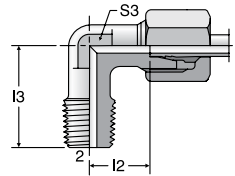


TABLE
OF
CONTENTS

VISUAL
INDEX

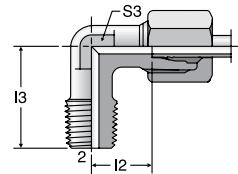
E

TUBE FITTING PART #	END SIZE		I 2 (mm)	I 3 (mm)	S3 (mm)	S3 Stainless Steel (mm)	Pressure Rating (bar)		
	1 (mm)	2 BSPT					EO		
							CF	71	MS
* WE04LLR	4	R1/8 keg.	11.0	17	11	9	100	100	63
* WE06LLR	6	R1/8 keg.	9.5	17	11	9	100	100	63
* WE08LLR	8	R1/8 keg.	11.5	20	12	12	100	100	63
* WE10LLR	10	R1/4 keg.	12.5	23	14	12	100	100	63
* WE12LLR	12	R1/4 keg.	13.0	23	17	14	100	100	63
* WE06LR	6	R1/8 keg.	12.0	20	12	12	315	315	200
* WE08LR	8	R1/4 keg.	14.0	26	14	12	315	315	200
* WE10LR	10	R1/4 keg.	15.0	27	17	14	315	315	200
* WE12LR	12	R3/8 keg.	17.0	28	19	17	315	315	200
* WE12LR1/4	12	R1/4 keg.	17.0	27	19	17	315	315	200
WE15LR	15	R1/2 keg.	21.0	34	19	19	315	315	200
WE18LR	18	R1/2 keg.	23.5	36	24	24	315	315	200
WE22LR3/4KEG	22	R3/4 keg.	27.5	42	27	27	160	160	100
* WE06SR	6	R1/4 keg.	16.0	26	14	12	400	400	250
* WE08SR	8	R1/4 keg.	17.0	27	17	14	400	400	250
* WE10SR	10	R3/8 keg.	17.5	28	19	17	400	400	250
* WE12SR	12	R3/8 keg.	21.5	28	22	17	400	400	250
WE14SR	14	R1/2 keg.	22.0	32	19	19	400	400	250
WE16SR	16	R1/2 keg.	24.5	32	24	24	400	400	250

* Extruded body for steel and brass.
Note: keg. refers to taper threads.

WE-M keg

Male Elbow
24° Flareless / Metric Taper Thread



TUBE FITTING PART #	END SIZE		I 2 (mm)	I 3 (mm)	S3 (mm)	S3 Stainless Steel (mm)	Pressure Rating (bar)		
	1 (mm)	2 Metric					EO		
							CF	71	MS
* WE06LLM	6	M10 x 1 keg.	9.5	17	11	9	100	100	63
* WE08LLM	8	M10 x 1 keg.	11.5	20	12	12	100	100	63
* WE06LM	6	M10 x 1 keg.	12.0	20	12	12	315	315	200
* WE08LM	8	M12 x 1.5 keg.	14.0	26	14	12	315	315	200
* WE10LM	10	M14 x 1.5 keg.	15.0	27	17	14	315	315	200
* WE12LM	12	M16 x 1.5 keg.	17.0	28	19	17	315	315	200
WE15LM	15	M18 x 1.5 keg.	21.0	32	19	19	315	315	200
WE18LM	18	M22 x 1.5 keg.	23.0	36	24	24	315	315	200
* WE06SM	6	M12 x 1.5 keg.	16.0	26	14	12	400	400	250
* WE08SM	8	M14 x 1.5 keg.	17.0	27	17	14	400	400	250
* WE10SM	10	M16 x 1.5 keg.	17.5	28	19	17	400	400	250
* WE12SM	12	M18 x 1.5 keg.	21.5	28	22	17	400	400	250
WE14SM	14	M20 x 1.5 keg.	22.0	32	19	19	400	400	250
WE16SM	16	M22 x 1.5 keg.	24.5	32	24	24	400	400	250

* Extruded body for steel and brass.
Note: keg. refers to taper threads.

Dimensions and pressures for reference only, subject to change.



WEE-UNF

Adjustable Locknut Elbow
24° Flareless / SAE-ORB

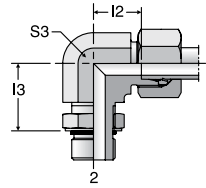


TABLE OF CONTENTS

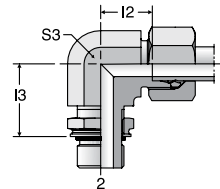
VISUAL INDEX

TUBE FITTING PART #	END SIZE		I2 (mm)	I3 (mm)	S3 (mm)	Pressure Rating (bar)			
	1 (mm)	2 UN / UNF				EO		EO-2	
						CF	71	CF	71
WEE06L7/16UNF	6	7/16-20	14	19	14	315	315	315	315
WEE08L7/16UNF	8	7/16-20	16	19	14	315	315	315	315
WEE10L9/16UNF	10	9/16-18	17	24	19	315	315	315	315
WEE12L9/16UNF	12	9/16-18	19	25	19	315	315	315	315
WEE12L3/4UNF	12	3/4-16	19	25	19	315	315	315	315
WEE15L3/4UNF	15	3/4-16	21	28	22	315	315	315	315
WEE15L7/8UNF	15	7/8-14	21	28	22	315	315	315	315
WEE18L7/8UNF	18	7/8-14	24	32	27	315	315	315	315
WEE18L11/16UN	18	1 1/16-12	24	32	30	315	315	315	315
WEE22L11/16UN	22	1 1/16-12	28	35	30	160	160	160	160
WEE28L15/16UN	28	1 5/16-12	31	42	36	160	160	160	160
WEE35L15/8UN	35	1 5/8-12	38	46	50	160	160	160	160
WEE42L17/8UN	42	1 7/8-12	38	47	50	160	160	160	160
WEE06S7/16UNF	6	7/16-20	15	20	14	400	400	400	400
WEE08S9/16UNF	8	9/16-18	17	25	19	400	400	400	400
WEE10S9/16UNF	10	9/16-18	18	26	19	400	400	400	400
WEE12S3/4UNF	12	3/4-16	22	30	22	400	400	400	400
WEE16S7/8UNF	16	7/8-14	25	34	27	400	400	400	400
WEE20S11/16UN	20	1 1/16-12	28	37	30	400	400	400	400
WEE25S11/16UN	25	1 1/16-12	30	50	36	400	400	400	400
WEE30S15/8UN	30	1 5/8-12	36	50	50	250	250	250	250
WEE38S17/8UN	38	1 7/8-12	34	51	50	250	250	250	250

For EO-2 part number, insert "Z" between size and pressure series.
Example: WEE06ZL7/16UNFCF

WEE-OR

Adjustable Locknut Elbow
24° Flareless / Metric ISO 6149



TUBE FITTING PART #	END SIZE		I2 (mm)	I3 (mm)	S3 (mm)	Pressure Rating (bar)			
	1 (mm)	2 Metric				EO		EO-2	
						CF	71	CF	71
WEE04LLMOR	4	M8 x 1	11.3	19.8	12	100	100	100	100
WEE04LLM10X1OR	4	M10 x 1	11.3	19.8	11	100	100	100	100
WEE06LLMOR	6	M10 x 1	9.8	19.8	14	100	100	100	100
WEE06LLM12X1.5OR	6	M12 x 1.5	12.8	23.2	14	100	100	100	100
WEE06LMOR	6	M10 x 1	14.0	20.0	14	315	315	315	315
WEE08LMOR	8	M12 x 1.5	16.0	22.0	14	315	315	315	315
WEE10LMOR	10	M14 x 1.5	17.0	25.0	19	315	315	315	315
WEE12LMOR	12	M16 x 1.5	19.0	26.0	19	315	315	315	315
WEE15LMOR	15	M18 x 1.5	21.0	30.0	22	315	315	315	315
WEE18LMOR	18	M22 x 1.5	24.0	33.0	27	315	315	315	315
WEE22LM27X2OR	22	M27 x 2	28.0	35.0	30	160	160	160	160
WEE28LMOR	28	M33 x 2	31.0	38.0	36	160	160	160	160
WEE35LMOR	35	M42 x 2	38.0	48.0	50	160	160	160	160
WEE42LMOR	42	M48 x 2	38.0	49.0	50	160	160	160	160
WEE06SMOR	6	M12 x 1.5	15.0	22.0	14	400	400	400	400
WEE08SMOR	8	M14 x 1.5	17.0	26.0	19	400	400	400	400
WEE10SMOR	10	M16 x 1.5	18.0	27.0	19	400	400	400	400
WEE12SMOR	12	M18 x 1.5	22.0	31.0	22	400	400	400	400
WEE16SMOR	16	M22 x 1.5	25.0	35.0	27	400	400	400	400
WEE20SMOR	20	M27 x 2	28.0	39.0	30	400	400	400	400
WEE25SMOR	25	M33 x 2	30.0	44.0	36	315	315	315	315
WEE30SMOR	30	M42 x 2	36.0	51.0	50	250	250	250	250
WEE38SMOR	38	M48 x 2	34.0	54.0	50	200	200	200	200

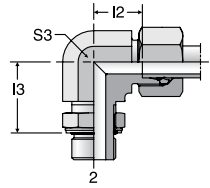
For EO-2 part number, insert "Z" between size and pressure series.
Example: WEE04ZLLMORCF

Dimensions and pressures for reference only, subject to change.



WEE-R

Adjustable Locknut Elbow
24° Flareless / BSPP ORR

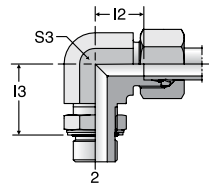


TUBE FITTING PART #	END SIZE		I 2 (mm)	I 3 (mm)	S3 (mm)	Pressure Rating (bar)			
	1 (mm)	2 BSPP				EO		EO-2	
						CF	71	CF	71
WEE04LLR	4	G 1/8A	11	20	11	250	250	250	250
WEE06LLR	6	G 1/8A	11	20	11	250	250	250	250
WEE06LR	6	G 1/8A	14	19	14	315	315	315	315
WEE08LR	8	G 1/4A	16	23	14	315	315	315	315
WEE10LR	10	G 1/4A	17	25	19	315	315	315	315
WEE12LR	12	G 3/8A	19	28	19	250	250	250	250
WEE15LR	15	G 1/2A	21	30	22	250	250	250	250
WEE18LR	18	G 1/2A	24	36	27	250	250	250	250
WEE22LR	22	G 3/4A	28	36	30	160	160	160	160
WEE28LR	28	G 1A	31	44	36	160	160	160	160
WEE35LR	35	G 1 1/4A	38	50	50	160	160	160	160
WEE42LR	42	G 1 1/2A	38	52	50	160	160	160	160
WEE06SR	6	G 1/4A	15	23	14	315	315	315	315
WEE08SR	8	G 1/4A	17	27	19	315	315	315	315
WEE10SR	10	G 3/8A	18	29	19	250	250	250	250
WEE12SR	12	G 3/8A	22	29	22	250	250	250	250
WEE16SR	16	G 1/2A	25	36	27	250	250	250	250
WEE20SR	20	G 3/4A	28	39	30	250	250	250	250
WEE25SR	25	G 1A	30	44	36	250	250	250	250
WEE30SR	30	G 1 1/4A	36	49	50	160	160	160	160
WEE38SR	38	G 1 1/2A	34	55	50	160	160	160	160

For EO-2 part number, insert "Z" between size and pressure series.
Example: WEE04ZLLRCF

WEE-M

Adjustable Locknut Elbow
24° Flareless / Metric ORR



TUBE FITTING PART #	END SIZE		I 2 (mm)	I 3 (mm)	S3 (mm)	Pressure Rating (bar)			
	1 (mm)	2 Metric				EO		EO-2	
						CF	71	CF	71
WEE06LM	6	M10 x 1	14	20	14	315	315	315	315
WEE08LM	8	M12 x 1.5	16	22	14	315	315	315	315
WEE10LM	10	M14 x 1.5	17	24	19	315	315	315	315
WEE12LM	12	M16 x 1.5	19	25	19	315	315	315	315
WEE15LM	15	M18 x 1.5	21	31	22	315	315	315	315
WEE18LM	18	M22 x 1.5	24	33	27	250	250	250	250
WEE22LM27X2	22	M27 x 2	28	36	30	160	160	160	160
WEE28LM	28	M33 x 2	31	39	36	160	160	160	160
WEE35LM	35	M42 x 2	38	49	50	160	160	160	160
WEE42LM	42	M48 x 2	38	50	50	160	160	160	160
WEE06SM	6	M12 x 1.5	15	22	14	315	315	315	315
WEE08SM	8	M14 x 1.5	17	26	19	315	315	315	315
WEE10SM	10	M16 x 1.5	18	27	19	315	315	315	315
WEE12SM	12	M18 x 1.5	22	31	22	315	315	315	315
WEE16SM	16	M22 x 1.5	25	36	27	250	250	250	250
WEE20SM	20	M27 x 2	28	39	30	250	250	250	250
WEE25SM	25	M33 x 2	30	44	36	160	160	160	160
WEE30SM	30	M42 x 2	36	51	50	160	160	160	160

For EO-2 part number, insert "Z" between size and pressure series.
Example: WEE06ZLMCF

TABLE OF CONTENTS

VISUAL INDEX

E

EW

Swivel Nut Elbow
 24° Flareless / Flareless Swivel

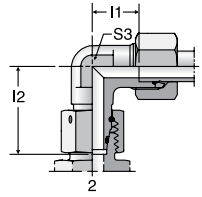


TABLE
 OF
 CONTENTS

VISUAL
 INDEX

TUBE FITTING PART #	END SIZE		I 1 (mm)	I 2 (mm)	S 3 (mm)	Pressure Rating (bar)			
	1 (mm)	2 Metric				EO		EO-2	
						CF	71	CF	71
EW06L	6	M12 x 1.5	12.0	26.0	12	500	315	500	315
EW08L	8	M14 x 1.5	14.0	27.5	12	500	315	500	315
EW10L	10	M16 x 1.5	15.0	29.0	14	500	315	500	315
EW12L	12	M18 x 1.5	17.0	29.5	17	400	315	400	315
EW15L	15	M22 x 1.5	21.0	32.5	19	400	315	400	315
EW18L	18	M26 x 1.5	23.5	35.5	24	400	315	400	315
EW22L	22	M30 x 2	27.5	38.5	27	250	160	250	160
EW28L	28	M36 x 2	30.5	41.5	36	250	160	250	160
EW35L	35	M45 x 2	34.5	51.0	41	250	160	250	160
EW42L	42	M52 x 2	40.0	56.0	50	250	160	250	160
EW06S	6	M14 x 1.5	16.0	27.0	12	800	630	800	630
EW08S	8	M16 x 1.5	17.0	27.5	14	800	630	800	630
EW10S	10	M18 x 1.5	17.5	30.0	17	800	630	800	630
EW12S	12	M20 x 1.5	21.5	31.0	17	630	630	630	630
EW14S	14	M22 x 1.5	22.0	35.0	19	630	630	630	630
EW16S	16	M24 x 1.5	24.5	36.5	24	630	400	630	400
EW20S	20	M30 x 2	26.5	44.5	27	420	400	420	400
EW25S	25	M36 x 2	30.0	50.0	36	420	400	420	400
EW30S	30	M42 x 2	35.5	55.0	41	420	400	420	400
EW38S	38	M52 x 2	41.0	63.0	50	420	315	420	315

For EO-2 part number, insert "Z" between size and pressure series.
 Example: EW06ZLCF

Dimensions and pressures for reference only, subject to change.



EW-R-ED

Assembled Adjustable Swivel Elbow
24° Flareless / BSPP with EOlastic Seal

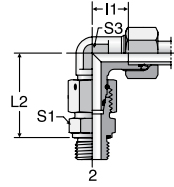


TABLE
OF
CONTENTS

VISUAL
INDEX

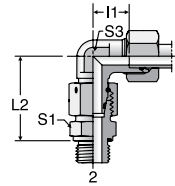
E

TUBE FITTING PART #	END SIZE		I 1 (mm)	L 2 (mm)	S 1 (mm)	S 3 (mm)	Pressure Rating (bar)			
	1 (mm)	2 BSPP					EO		EO-2	
							CF	71	CF	71
EW06LRED	6	G 1/8 A	12.0	34.5	14	12	500	315	500	315
EW08LRED	8	G 1/4 A	14.0	37.5	19	12	500	315	500	315
EW10LRED	10	G 1/4 A	15.0	40.0	19	14	500	315	500	315
EW12LRED	12	G 3/8 A	17.0	42.0	22	17	400	315	400	315
EW15LRED	15	G 1/2 A	21.0	46.5	27	19	400	315	400	315
EW18LRED	18	G 1/2 A	23.5	50.0	27	24	400	315	400	315
EW22LRED	22	G 3/4 A	27.5	55.0	32	27	250	160	250	160
EW28LRED	28	G 1 A	30.5	59.0	41	36	250	160	250	160
EW35LRED	35	G 1 1/4 A	34.5	68.5	50	41	250	160	250	160
EW42LRED	42	G 1 1/2 A	40.0	75.0	55	50	250	160	250	160
EW06SRED	6	G 1/4 A	16.0	40.0	19	12	800	630	800	630
EW08SRED	8	G 1/4 A	17.0	42.5	19	14	800	630	800	630
EW10SRED	10	G 3/8 A	17.5	45.0	22	17	800	630	800	630
EW12SRED	12	G 3/8 A	21.5	48.0	22	17	630	630	630	630
EW14SRED	14	G 1/2 A	22.0	54.0	27	19	630	630	630	630
EW16SRED	16	G 1/2 A	24.5	55.0	27	24	630	400	630	400
EW20SRED	20	G 3/4 A	26.5	65.0	32	27	420	400	420	400
EW25SRED	25	G 1 A	30.0	73.0	41	36	420	400	420	400
EW30SRED	30	G 1 1/4 A	35.5	78.5	50	41	420	400	420	400
EW38SRED	38	G 1 1/2 A	41.0	89.0	55	50	420	315	420	315

For EO-2 part number, insert "Z" between size and pressure series.
Example: EW06ZLREDCF

EW-M-ED

Assembled Adjustable Swivel Elbow
24° Flareless / Metric Parallel with EOlastic Seal



TUBE FITTING PART #	END SIZE		I 1 (mm)	L 2 (mm)	S 1 (mm)	S 3 (mm)	Pressure Rating (bar)			
	1 (mm)	2 Metric					EO		EO-2	
							CF	71	CF	71
EW06LMED	6	M10 x 1	12	34.5	14	12	500	315	500	315
EW08LMED	8	M12 x 1.5	14	37.5	17	12	500	315	500	315
EW10LMED	10	M14 x 1.5	15	40.0	19	14	500	315	500	315
EW12LMED	12	M16 x 1.5	17	42.0	22	17	400	315	400	315
EW15LMED	15	M18 x 1.5	21	46.0	24	19	400	315	400	315
EW18LMED	18	M22 x 1.5	23.5	50.0	27	24	400	315	400	315
EW22LMED	22	M26 x 1.5	27.5	55.0	32	27	250	160	250	160
EW28LMED	28	M33 x 2	30.5	59.0	41	36	250	160	250	160
EW35LMED	35	M42 x 2	34.5	68.5	50	41	250	160	250	160
EW42LMED	42	M48 x 2	40	75.0	55	50	250	160	250	160
EW06SMED	6	M12 x 1.5	16	40.0	17	12	800	630	800	630
EW08SMED	8	M14 x 1.5	17	42.5	19	14	800	630	800	630
EW10SMED	10	M16 x 1.5	17.5	45.0	22	17	800	630	800	630
EW12SMED	12	M18 x 1.5	21.5	48.0	24	17	630	630	630	630
EW14SMED	14	M20 x 1.5	22	54.0	27	19	630	630	630	630
EW16SMED	16	M22 x 1.5	24.5	55.0	27	24	630	400	630	400
EW20SMED	20	M27 x 2	26.5	65.0	32	27	420	400	420	400
EW25SMED	25	M33 x 2	30	73.0	41	36	420	400	420	400
EW30SMED	30	M42 x 2	35.5	78.5	50	41	420	400	420	400
EW38SMED	38	M48 x 2	41	89.0	55	50	420	315	420	315

For EO-2 part number, insert "Z" between size and pressure series.
Example: EW06ZLMEDCF

Dimensions and pressures for reference only, subject to change.

SWVE-R

Banjo Elbow
24° Flareless / BSPP

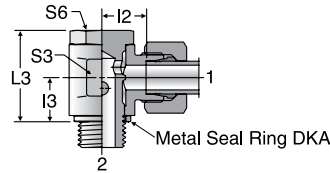


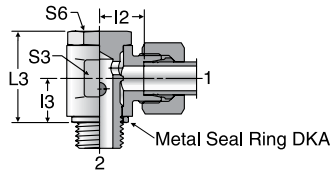
TABLE
OF
CONTENTS

VISUAL
INDEX

TUBE FITTING PART #	END SIZE		I 2 (mm)	I 3 (mm)	L 3 (mm)	S 3 (mm)	S 6 (mm)	Pressure Rating (bar)	
	1 (mm)	2 BSPP						EO	CF
	SWVE04LLR	4						G 1/8 A	11.5
SWVE06LLR	6	G 1/8 A	10.0	10.0	21.5	14	14	63	
SWVE08LLR	8	G 1/8 A	11.0	10.0	21.0	14	14	63	
SWVE06LR	6	G 1/8 A	10.5	10.0	21.0	14	14	160	
SWVE08LR	8	G 1/4 A	13.0	13.0	27.0	19	19	160	
SWVE10LR	10	G 1/4 A	14.0	13.0	27.0	19	19	160	
SWVE12LR	12	G 3/8 A	15.5	15.0	32.0	22	22	100	
SWVE15LR	15	G 1/2 A	19.0	18.0	37.5	27	27	100	
SWVE18LR	18	G 1/2 A	20.5	21.5	44.5	30	27	100	
SWVE22LR	22	G 3/4 A	25.5	24.0	49.0	36	32	100	
SWVE06SR	6	G 1/4 A	15.0	13.0	27.0	19	19	160	
SWVE08SR	8	G 1/4 A	15.0	13.0	27.0	19	19	160	
SWVE10SR	10	G 3/8 A	16.0	15.0	32.0	22	22	100	
SWVE12SR	12	G 3/8 A	17.0	18.0	37.0	24	24	100	
SWVE14SR	14	G 1/2 A	20.0	18.0	37.5	27	27	100	
SWVE16SR	16	G 1/2 A	21.5	21.5	44.5	30	27	100	
SWVE20SR	20	G 3/4 A	24.5	24.0	49.0	36	32	100	

SWVE-M

Banjo Elbow
24° Flareless / Metric Parallel



TUBE FITTING PART #	END SIZE		I 2 (mm)	I 3 (mm)	L 3 (mm)	S 3 (mm)	S 6 (mm)	Pressure Rating (bar)	
	1 (mm)	2 Metric						EO	CF
	SWVE04LLM	4						M8 x 1	10.5
SWVE06LLM	6	M10 x 1	10.0	10.0	21.0	14	14	63	
SWVE08LLM	8	M10 x 1	11.0	10.0	21.0	14	14	63	
SWVE06LM	6	M10 x 1	10.5	10.0	21.5	14	14	160	
SWVE08LM	8	M12 x 1.5	12.0	12.0	25.0	17	17	160	
SWVE10LM	10	M14 x 1.5	14.0	13.0	27.0	19	19	160	
SWVE12LM	12	M16 x 1.5	15.5	15.0	32.0	22	21	100	
SWVE15LM	15	M18 x 1.5	17.5	18.0	37.5	24	24	100	
SWVE18LM	18	M22 x 1.5	20.5	21.5	44.5	30	27	100	
SWVE22LM	22	M26 x 1.5	25.5	24.0	49.0	36	32	100	
SWVE06SM	6	M12 x 1.5	14.0	12.0	25.0	17	17	160	
SWVE08SM	8	M14 x 1.5	15.0	13.0	27.0	19	19	160	
SWVE10SM	10	M16 x 1.5	16.0	15.0	32.0	22	22	100	
SWVE12SM	12	M18 x 1.5	17.0	18.0	37.0	24	24	100	
SWVE14SM	14	M20 x 1.5	20.0	18.0	37.0	27	27	100	
SWVE16SM	16	M22 x 1.5	21.5	21.5	44.5	30	27	100	
SWVE20SM	20	M27 x 2	24.5	24.0	49.0	36	32	100	

Dimensions and pressures for reference only, subject to change.

WH-R

High Pressure Banjo Elbow
24° Flareless / BSPP

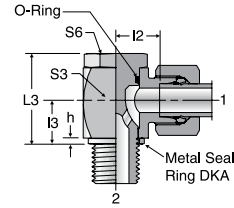


TABLE
OF
CONTENTS

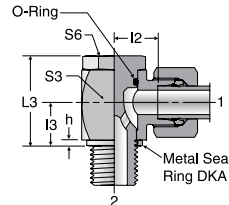
VISUAL
INDEX

E

TUBE FITTING PART #	END SIZE		h (mm)	I2 (mm)	I3 (mm)	L3 (mm)	S3 (mm)	S6 (mm)	Pressure Rating (bar)				
	1 (mm)	2 BSPP							EO		EO-2		
									CF	71	MS	CF	71
WH06LR	6	G 1/8 A	2.5	12.0	10.5	24	17	17	250	250	160	250	250
WH08LR	8	G 1/4 A	3.0	14.5	14.0	30	22	19	250	250	160	250	250
WH10LR	10	G 1/4 A	3.0	15.5	14.0	30	22	19	250	250	160	250	250
WH12LR	12	G 3/8 A	3.0	18.0	16.5	36	27	24	250	250	160	250	250
WH15LR	15	G 1/2 A	4.5	21.5	21.5	45	32	30	250	250	160	250	250
WH18LR	18	G 1/2 A	4.5	21.0	21.5	45	32	30	250	250	160	250	250
WH22LR	22	G 3/4 A	3.5	27.5	24.0	53	41	36	160	160	100	160	160
WH28LR	28	G 1 A	3.5	32.0	30.5	66	50	46	160	160	100	160	160
WH35LR	35	G 1 1/4 A	3.5	36.0	35.5	76	60	55	160	160	100	160	160
WH42LR	42	G 1 1/2 A	3.5	40.5	40.5	87	70	60	160	160	100	160	160
WH06SR	6	G 1/4 A	3.0	16.5	14.0	30	22	19	315	315	200	315	315
WH08SR	8	G 1/4 A	3.0	16.5	14.0	30	22	19	315	315	200	315	315
WH10SR	10	G 3/8 A	3.0	18.5	16.5	36	27	24	315	315	200	315	315
WH12SR	12	G 3/8 A	3.0	18.5	16.5	36	27	24	315	315	200	315	315
WH14SR	14	G 1/2 A	4.5	22.5	21.5	45	32	30	315	315	200	315	315
WH16SR	16	G 1/2 A	4.5	22.0	21.5	45	32	30	315	315	200	315	315
WH20SR	20	G 3/4 A	3.5	26.5	24.0	53	41	36	160	160	100	160	160
WH25SR	25	G 1 A	3.5	31.5	30.5	66	50	46	160	160	100	160	160
WH30SR	30	G 1 1/4 A	3.5	37.0	35.5	76	60	55	160	160	100	160	160
WH38SR	38	G 1 1/2 A	3.5	41.5	40.5	87	70	60	160	160	100	160	160

WH-M

High Pressure Banjo Elbow
24° Flareless / Metric Parallel



TUBE FITTING PART #	END SIZE		h (mm)	I2 (mm)	I3 (mm)	L3 (mm)	S3 (mm)	S6 (mm)	Pressure Rating (bar)			
	1 (mm)	2 Metric							EO		EO-2	
									CF	71	CF	71
WH06LM	6	M10 x 1	2.5	12.0	10.5	24	17	17	250	250	250	250
WH08LM	8	M12 x 1.5	3.0	14.5	14.0	30	22	19	250	250	250	250
WH10LM	10	M14 x 1.5	3.0	15.5	14.0	30	22	19	250	250	250	250
WH12LM	12	M16 x 1.5	3.0	18.0	16.5	36	27	24	250	250	250	250
WH15LM	15	M18 x 1.5	3.0	21.5	18.5	39.5	30	27	250	250	250	250
WH18LM	18	M22 x 1.5	4.5	21.0	21.5	45	32	30	250	250	250	250
WH22LM	22	M26 x 1.5	3.5	27.5	24.0	53	41	36	160	160	160	160
WH28LM	28	M33 x 2	3.5	32.0	30.5	66	50	46	160	160	160	160
WH35LM	35	M42 x 2	3.5	36.0	35.5	76	60	55	160	160	160	160
WH42LM	42	M48 x 2	3.5	40.5	40.5	87	70	60	160	160	160	160
WH06SM	6	M12 x 1.5	3.0	16.5	14.0	30	22	19	315	315	315	315
WH08SM	8	M14 x 1.5	3.0	16.5	14.0	30	22	19	315	315	315	315
WH10SM	10	M16 x 1.5	3.0	18.5	16.5	36	27	24	315	315	315	315
WH12SM	12	M18 x 1.5	3.0	20.0	18.5	39.5	27	27	315	315	315	315
WH14SM	14	M20 x 1.5	3.0	22.5	20.0	43.5	32	30	315	315	315	315
WH16SM	16	M22 x 1.5	4.5	22.0	21.5	45	32	30	315	315	315	315
WH20SM	20	M27 x 2	3.5	26.5	24.0	53	41	36	160	160	160	160
WH25SM	25	M33 x 2	3.5	31.5	30.5	66	50	46	160	160	160	160
WH30SM	30	M42 x 2	3.5	37.0	35.5	76	60	55	160	160	160	160
WH38SM	38	M48 x 2	3.5	41.5	40.5	87	70	60	160	160	160	160

Dimensions and pressures for reference only, subject to change.



WH-R-KDS

High Pressure Banjo Elbow
24° Flareless / BSPP

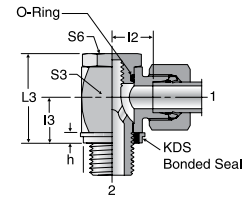


TABLE OF CONTENTS
VISUAL INDEX

TUBE FITTING PART #	END SIZE		h (mm)	I 2 (mm)	I 3 (mm)	L3 (mm)	S3 (mm)	S6 (mm)	Pressure Rating (bar)			
	1 (mm)	2 BSPP							EO		EO-2	
									CF	71	CF	71
WH06LRKDS	6	G 1/8 A	2.5	12.0	10.5	24	17	17	315	315	315	315
WH08LRKDS	8	G 1/4 A	3.0	14.5	14.0	30	22	19	315	315	315	315
WH10LRKDS	10	G 1/4 A	3.0	15.5	14.0	30	22	19	315	315	315	315
WH12LRKDS	12	G 3/8 A	3.0	18.0	16.5	36	27	24	315	315	315	315
WH15LRKDS	15	G 1/2 A	4.5	21.5	21.5	45	32	30	315	315	315	315
WH18LRKDS	18	G 1/2 A	4.5	21.0	21.5	45	32	30	315	315	315	315
WH22LRKDS	22	G 3/4 A	3.5	27.5	24.0	53	41	36	160	160	160	160
WH28LRKDS	28	G 1 A	3.5	32.0	30.5	66	50	46	160	160	160	160
WH35LRKDS	35	G 1 1/4 A	3.5	36.0	35.5	76	60	55	160	160	160	160
WH42LRKDS	42	G 1 1/2 A	3.5	40.5	40.5	87	70	60	160	160	160	160
WH06SRKDS	6	G 1/4 A	3.0	16.5	14.0	30	22	19	400	400	400	400
WH08SRKDS	8	G 1/4 A	3.0	16.5	14.0	30	22	19	400	400	400	400
WH10SRKDS	10	G 3/8 A	3.0	18.5	16.5	36	27	24	400	400	400	400
WH12SRKDS	12	G 3/8 A	3.0	18.5	16.5	36	27	24	400	400	400	400
WH14SRKDS	14	G 1/2 A	4.5	22.5	21.5	45	32	30	400	400	400	400
WH16SRKDS	16	G 1/2 A	4.5	22.0	21.5	45	32	30	315	315	315	315
WH20SRKDS	20	G 3/4 A	3.5	26.5	24.0	53	41	36	315	315	315	315
WH25SRKDS	25	G 1 A	3.5	31.5	30.5	66	50	46	250	250	250	250
WH30SRKDS	30	G 1 1/4 A	3.5	37.0	35.5	76	60	55	160	160	160	160
WH38SRKDS	38	G 1 1/2 A	3.5	41.5	40.5	87	70	60	160	160	160	160

For EO-2 part number, insert "Z" between size and pressure series.

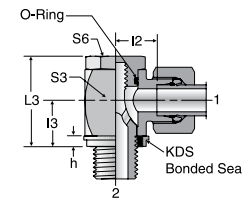
Example WH06ZLRKDSCF

*Stainless Steel (71) part numbers have KD instead of KDS.

Example: WHO6SRKD71

WH-M-KDS

High Pressure Banjo Elbow
Banjo Metric / Flareless



TUBE FITTING PART #	END SIZE		h (mm)	I 2 (mm)	I 3 (mm)	L3 (mm)	S3 (mm)	S6 (mm)	Pressure Rating (bar)			
	1 (mm)	2 Metric							EO		EO-2	
									CF	71	CF	71
WH06LMKDS	6	M10 x 1	2.5	12.0	10.5	24.0	17	17	315	315	315	315
WH08LMKDS	8	M12 x 1.5	3.0	14.5	14.0	30.0	22	19	315	315	315	315
WH10LMKDS	10	M14 x 1.5	3.0	15.5	14.0	30.0	22	19	315	315	315	315
WH12LMKDS	12	M16 x 1.5	3.0	18.0	16.5	36.0	27	24	315	315	315	315
WH15LMKDS	15	M18 x 1.5	3.0	21.5	18.5	39.5	30	30	315	315	315	315
WH18LMKDS	18	M22 x 1.5	4.5	21.0	21.5	45.0	32	30	315	315	315	315
WH22LMKDS	22	M26 x 1.5	3.5	27.5	24.0	53.0	41	36	160	160	160	160
WH28LMKDS	28	M33 x 2	3.5	32.0	30.5	66.0	50	46	160	160	160	160
WH35LMKDS	35	M42 x 2	3.5	36.0	35.5	76.0	60	55	160	160	160	160
WH42LMKDS	42	M48 x 2	3.5	40.5	40.5	87.0	70	60	160	160	160	160
WH06SMKDS	6	M12 x 1.5	3.0	16.5	14.0	30.0	22	19	400	400	400	400
WH08SMKDS	8	M14 x 1.5	3.0	16.5	14.0	30.0	22	19	400	400	400	400
WH10SMKDS	10	M16 x 1.5	3.0	18.5	16.5	36.0	27	24	400	400	400	400
WH12SMKDS	12	M18 x 1.5	3.0	20.0	18.5	39.5	27	27	400	400	400	400
WH14SMKDS	14	M20 x 1.5	3.0	22.5	20.0	43.5	32	30	400	400	400	400
WH16SMKDS	16	M22 x 1.5	4.5	22.0	21.5	45.0	32	30	315	315	315	315
WH20SMKDS	20	M27 x 2	3.5	26.5	24.0	53.0	41	36	315	315	315	315
WH25SMKDS	25	M33 x 2	3.5	31.5	30.5	66.0	50	46	250	250	250	250
WH30SMKDS	30	M42 x 2	3.5	37.0	35.5	76.0	60	55	160	160	160	160
WH38SMKDS	38	M48 x 2	3.5	41.5	40.5	87.0	70	60	160	160	160	160

For EO-2 part number, insert "Z" between size and pressure series.

Example: WH06ZLMKDSCF

*Stainless Steel (71) part numbers have KD instead of KDS.

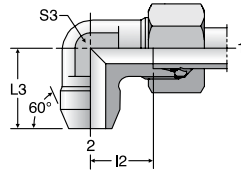
Example: WH06SMKD71

Dimensions and pressures for reference only, subject to change.



WAS

Weld Elbow
24° Flareless / Butt Weld



T

Union Tee
24° Flareless

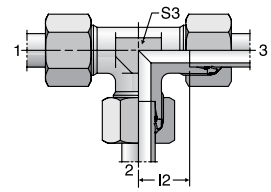


TABLE OF CONTENTS

VISUAL INDEX

E

TUBE FITTING PART #	END SIZE		I 2 (mm)	L3 (mm)	S3 (mm)	Pressure Rating (bar)			
	1 (mm)	2 (mm)				EO		EO-2	
						CF	71	CF	71
WAS06L	6	10	12.0	19	12	315	315	315	315
WAS08L	8	12	14.0	23	12	315	315	315	315
WAS10L	10	14	15.0	24	14	315	315	315	315
WAS12L	12	16	17.0	25	17	315	315	315	315
WAS15L	15	19	21.0	30	19	315	315	315	315
WAS18L	18	22	23.5	33	24	315	315	315	315
WAS22L	22	27	27.5	37	27	160	160	160	160
WAS28L	28	32	30.5	42	36	160	160	160	160
WAS35L	35	40	34.5	49	41	160	160	160	160
WAS42L	42	46	40.0	57	50	160	160	160	160
WAS06S	6	11	16.0	23	12	630	630	630	630
WAS08S	8	13	17.0	24	14	630	630	630	630
WAS10S	10	15	17.5	25	17	630	630	630	630
WAS12S	12	17	21.5	29	17	630	630	630	630
WAS14S	14	19	22.0	30	19	630	630	630	630
WAS16S	16	21	24.5	33	24	400	400	400	400
WAS20S	20	26	26.5	37	27	400	400	400	400
WAS25S	25	31	30.0	42	36	400	400	400	400
WAS30S	30	36	35.5	49	41	400	400	400	400
WAS38S	38	44	41.0	57	50	315	315	315	315

Note: Weld fitting. Omit "CF" in the part number for steel material.
For EO-2 part number, insert "Z" between size and pressure series.
Example: WAS06ZL

TUBE FITTING PART #	END SIZE		I 2 (mm)	S3 (mm)	S3 (Only Stainless Steel) (mm)	Pressure Rating (bar)				
	1 - 3 (mm)					EO			EO-2	
						CF	71	MS	CF	71
*T04LL	4	11.0	9	9	9	100	100	63	100	100
*T06LL	6	9.5	11	9	9	100	100	63	100	100
*T08LL	8	11.5	12	12	12	100	100	63	100	100
*T10LL	10	12.5	14	12	12	100	100	63	100	100
T12LL	12	15.0	14	14	14	100	100	63	100	100
*T06L	6	12.0	12	12	12	500	315	200	500	315
*T08L	8	14.0	14	12	12	500	315	200	500	315
T10L	10	15.0	14	14	14	500	315	200	500	315
T12L	12	17.0	17	17	17	400	315	200	400	315
T15L	15	21.0	19	19	19	400	315	200	400	315
T18L	18	23.5	24	24	24	400	315	200	400	315
T22L	22	27.5	27	27	27	250	160	100	250	160
T28L	28	30.5	36	36	36	250	160	100	250	160
T35L	35	34.5	41	41	41	250	160	100	250	160
T42L	42	40.0	50	50	50	250	160	100	250	160
*T06S	6	16.0	14	12	12	800	630	400	800	630
T08S	8	17.0	14	14	14	800	630	400	800	630
T10S	10	17.5	17	17	17	800	630	400	800	630
T12S	12	21.5	17	17	17	630	630	400	630	630
T14S	14	22.0	19	19	19	630	630	400	630	630
T16S	16	24.5	24	24	24	630	400	250	630	400
T20S	20	26.5	27	27	27	420	400	250	420	400
T25S	25	30.0	36	36	36	420	400	250	420	400
T30S	30	35.5	41	41	41	420	400	250	420	400
T38S	38	41.0	50	50	50	420	315	200	420	315

* Extruded body for steel and brass.
For EO-2 part number, insert "Z" between size and pressure series.
Example: T04ZLLCF

TR
Tee-Reducer
24° Flareless

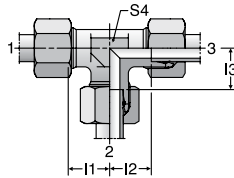


TABLE OF CONTENTS

VISUAL INDEX

TUBE FITTING PART #	END SIZE			I 1 (mm)	I 2 (mm)	I 3 (mm)	S4 (mm)	S4 (Stainless Steel) (mm)	Pressure Rating (bar)				
	1 (mm)	2 (mm)	3 (mm)						EO		EO-2		
									CF	71	MS	CF	71
*TR04/08/04LL	4	8	4	13.0	13.0	11.5	12	12	100	100	63	100	100
*TR06/04/06LL	6	4	6	9.5	9.5	11.0	11	9	100	100	63	100	100
*TR06/08/06L	6	8	6	14.0	14.0	14.0	14	12	500	315	200	500	315
*TR08/06/08L	8	6	8	14.0	14.0	14.0	14	12	500	315	200	500	315
TR06/10/06L	6	10	6	15.0	15.0	15.0	14	14	500	315	200	500	315
TR08/10/08L	8	10	8	15.0	15.0	15.0	14	14	500	315	200	500	315
TR10/06/10L	10	6	10	15.0	15.0	15.0	14	14	500	315	200	500	315
TR10/08/10L	10	8	10	15.0	15.0	15.0	14	14	500	315	200	500	315
TR10/10/06L	10	10	6	15.0	15.0	15.0	14	14	500	315	200	500	315
TR08/12/08L	8	12	8	17.0	17.0	17.0	17	17	400	315	200	400	315
TR12/06/12L	12	6	12	17.0	17.0	17.0	17	17	400	315	200	400	315
TR12/08/08L	12	8	8	17.0	17.0	17.0	17	17	400	315	200	400	315
TR12/08/12L	12	8	12	17.0	17.0	17.0	17	17	400	315	200	400	315
TR12/10/10L	12	10	10	17.0	17.0	17.0	17	17	400	315	200	400	315
TR12/10/12L	12	10	12	17.0	17.0	17.0	17	17	400	315	200	400	315
TR12/12/10L	12	12	10	17.0	17.0	17.0	17	17	400	315	200	400	315
TR10/15/10L	10	15	10	21.0	21.0	21.0	19	19	400	315	200	400	315
TR12/15/12L	12	15	12	21.0	21.0	21.0	19	19	400	315	200	400	315
TR15/06/15L	15	6	15	21.0	21.0	21.0	19	19	400	315	200	400	315
TR15/10/15L	15	10	15	21.0	21.0	21.0	19	19	400	315	200	400	315
TR15/12/12L	15	12	12	21.0	21.0	21.0	19	19	400	315	200	400	315
TR15/12/15L	15	12	15	21.0	21.0	21.0	19	19	400	315	200	400	315
TR15/15/12L	15	15	12	21.0	21.0	21.0	19	19	400	315	200	400	315
TR12/18/12L	12	18	12	24.0	24.0	23.5	24	24	400	315	200	400	315
TR18/10/10L	18	10	10	23.5	24.0	24.0	24	24	400	315	200	400	315
TR18/10/18L	18	10	18	23.5	23.5	24.0	24	24	400	315	200	400	315
TR18/12/18L	18	12	18	23.5	23.5	24.0	24	24	400	315	200	400	315
TR18/15/18L	18	15	18	23.5	23.5	24.0	24	24	400	315	200	400	315
TR18/18/10L	18	18	10	23.5	24.0	23.5	24	24	400	315	200	400	315
TR22/10/22L	22	10	22	27.5	27.5	28.0	27	27	250	160	100	250	160
TR22/12/22L	22	12	22	27.5	27.5	28.0	27	27	250	160	100	250	160
TR22/15/15L	22	15	15	27.5	28.0	28.0	27	27	250	160	100	250	160
TR22/15/22L	22	15	22	27.5	27.5	28.0	27	27	250	160	100	250	160
TR22/18/18L	22	18	18	27.5	27.5	27.5	27	27	250	160	100	250	160
TR22/18/22L	22	18	22	27.5	27.5	27.5	27	27	250	160	100	250	160
TR22/22/18L	22	22	18	27.5	27.5	27.5	27	27	250	160	100	250	160
TR28/10/28L	28	10	28	30.5	30.5	31.0	36	36	250	160	100	250	160
TR28/12/28L	28	12	28	30.5	30.5	31.0	36	36	250	160	100	250	160
TR28/15/28L	28	15	28	30.5	30.5	31.0	36	36	250	160	100	250	160
TR28/18/28L	28	18	28	30.5	30.5	30.5	36	36	250	160	100	250	160
TR28/22/22L	28	22	22	30.5	30.5	30.5	36	36	250	160	100	250	160
TR28/22/28L	28	22	28	30.5	30.5	30.5	36	36	250	160	100	250	160

*Extruded body for steel and brass.

Series S is continued on the next page.

For EO-2 part number, insert "Z" between size and pressure series.

Example: TR06/08/06ZLLCF

Dimensions and pressures for reference only, subject to change.



TR
Tee-Reducer
24° Flareless

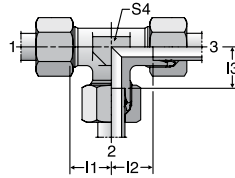


TABLE
OF
CONTENTS

VISUAL
INDEX

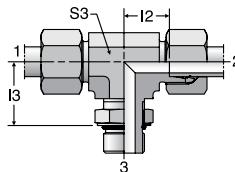
E

TUBE FITTING PART #	END SIZE			I1 (mm)	I2 (mm)	I3 (mm)	S4 (mm)	Pressure Rating (bar)				
	1 (mm)	2 (mm)	3 (mm)					EO		EO-2		
								CF	71	MS	CF	71
TR10/06/10S	10	6	10	17.5	17.5	18.0	17	800	630	400	800	630
TR12/08/08S	12	8	8	21.5	22.0	22.0	17	630	630	400	630	630
TR12/08/12S	12	8	12	21.5	21.5	22.0	17	630	630	400	630	630
TR12/10/12S	12	10	12	21.5	21.5	21.5	17	630	630	400	630	630
TR12/16/12S	12	16	12	25.5	25.5	24.5	24	630	400	250	630	400
TR16/06/16S	16	6	16	24.5	24.5	26.0	24	630	400	250	630	400
TR16/08/16S	16	8	16	24.5	24.5	26.0	24	630	400	250	630	400
TR16/10/16S	16	10	16	24.5	24.5	25.5	24	630	400	250	630	400
TR16/12/16S	16	12	16	24.5	24.5	25.5	24	630	400	250	630	400
TR16/20/16S	16	20	16	28.5	28.5	26.5	27	420	400	250	420	400
TR20/10/20S	20	10	20	26.5	26.5	29.5	27	420	400	250	420	400
TR20/12/20S	20	12	20	26.5	26.5	29.5	27	420	400	250	420	400
TR20/16/20S	20	16	20	26.5	26.5	28.5	27	420	400	250	420	400
TR20/25/20S	20	25	20	31.5	31.5	30.0	36	420	400	250	420	400
TR25/16/25S	25	16	25	30.0	30.0	33.5	36	420	400	250	420	400
TR25/20/25S	25	20	25	30.0	30.0	31.5	36	420	400	250	420	400
TR25/30/25S	25	30	25	37.0	37.0	35.5	41	420	400	250	420	400

Series L is on the previous page.

For EO-2 part number, insert "Z" between size and pressure series.
Example: TR10/06/10ZSCF

TEE-UNF
Adjustable Locknut Branch Tee
24° Flareless / SAE-ORB



TUBE FITTING PART #	END SIZE		I2 (mm)	I3 (mm)	S3 (mm)	Pressure Rating (bar)			
	1 & 2 (mm)	3 UN/UNF-2A				EO		EO-2	
						CF	71	CF	71
TEE06L7/16UNF	6	7/16-20	14	19	14	315	315	315	315
TEE08L7/16UNF	8	7/16-20	16	19	14	315	315	315	315
TEE10L9/16UNF	10	9/16-18	17	24	19	315	315	315	315
TEE12L9/16UNF	12	9/16-18	19	25	19	315	315	315	315
TEE12L3/4UNF	12	3/4-16	19	25	19	315	315	315	315
TEE15L3/4UNF	15	3/4-16	21	28	22	315	315	315	315
TEE15L7/8UNF	15	7/8-14	21	28	22	315	315	315	315
TEE18L7/8UNF	18	7/8-14	24	32	27	315	315	315	315
TEE18L11/16UN	18	1 1/16-12	24	32	30	315	315	315	315
TEE22L11/16UN	22	1 1/16-12	28	35	30	160	160	160	160
TEE28L15/16UN	28	1 5/16-12	31	42	36	160	160	160	160
TEE35L15/8UN	35	1 5/8-12	38	46	50	160	160	160	160
TEE42L17/8UN	42	1 7/8-12	38	47	50	160	160	160	160
TEE06S7/16UNF	6	7/16-20	15	20	14	400	400	400	400
TEE08S9/16UNF	8	9/16-18	17	25	19	400	400	400	400
TEE10S9/16UNF	10	9/16-18	18	26	19	400	400	400	400
TEE12S3/4UNF	12	3/4-16	22	30	22	400	400	400	400
TEE16S7/8UNF	16	7/8-14	25	34	27	400	400	400	400
TEE20S11/16UN	20	1 1/16-12	28	37	30	400	400	400	400
TEE25S11/16UN	25	1 1/16-12	30	50	36	400	400	400	400
TEE30S15/8UN	30	1 5/8-12	36	50	50	250	250	250	250
TEE38S17/8UN	38	1 7/8-12	34	51	50	250	250	250	250

For EO-2 part number, insert "Z" between size and pressure series.
Example: TEE06ZL7/16UNFCF

Dimensions and pressures for reference only, subject to change.



TEE-OR

Adjustable Locknut Branch Tee
24° Flareless / Metric ISO 6149

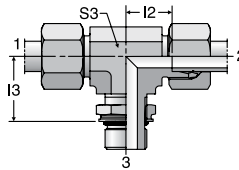


TABLE OF CONTENTS

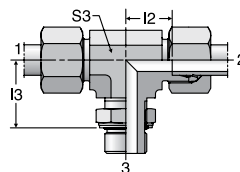
VISUAL INDEX

TUBE FITTING PART #	END SIZE		I 2 (mm)	I 3 (mm)	S 3 (mm)	Pressure Rating (bar)			
	1 & 2 (mm)	3 Metric				EO		EO-2	
						CF	71	CF	71
TEE06LMOR	6	M10x1	14	20	14	315	315	315	315
TEE08LMOR	8	M12x1.5	16	22	14	315	315	315	315
TEE10LMOR	10	M14x1.5	17	25	19	315	315	315	315
TEE12LMOR	12	M16x1.5	19	26	19	315	315	315	315
TEE15LMOR	15	M18x1.5	21	30	22	315	315	315	315
TEE18LMOR	18	M22x1.5	24	33	27	315	315	315	315
TEE22LM27X2OR	22	M27x2	28	35	30	160	160	160	160
TEE28LMOR	28	M33x2	31	38	36	160	160	160	160
TEE35LMOR	35	M42x2	38	48	50	160	160	160	160
TEE42LMOR	42	M48x2	38	49	50	160	160	160	160
TEE06SMOR	6	M12x1.5	15	22	14	400	400	400	400
TEE08SMOR	8	M14x1.5	17	26	19	400	400	400	400
TEE10SMOR	10	M16x1.5	18	27	19	400	400	400	400
TEE12SMOR	12	M18x1.5	22	31	22	400	400	400	400
TEE16SMOR	16	M22x1.5	25	35	27	400	400	400	400
TEE20SMOR	20	M27x2	28	39	30	400	400	400	400
TEE25SMOR	25	M33x2	30	44	36	315	315	315	315
TEE30SMOR	30	M42x2	36	51	50	250	250	250	250
TEE38SMOR	38	M48x2	34	54	50	200	200	200	200

For EO-2 part number, insert "Z" between size and pressure series.
Example: TR06ZLMORCF

TEE-R

Adjustable Locknut Branch Tee
24° Flareless / BSPP ORR



TUBE FITTING PART #	END SIZE		I 2 (mm)	I 3 (mm)	S 3 (mm)	Pressure Rating (bar)			
	1 & 2 (mm)	3 BSPP				EO		EO-2	
						CF	71	CF	71
TEE06LR	6	G 1/8A	14	19	14	315	315	315	315
TEE08LR	8	G 1/4A	16	23	14	315	315	315	315
TEE10LR	10	G 1/4A	17	25	19	315	315	315	315
TEE12LR	12	G 3/8A	19	28	19	250	250	250	250
TEE15LR	15	G 1/2A	21	30	22	250	250	250	250
TEE18LR	18	G 1/2A	24	36	27	250	250	250	250
TEE22LR	22	G 3/4A	28	36	30	160	160	160	160
TEE28LR	28	G 1A	31	44	36	160	160	160	160
TEE35LR	35	G 1 1/4A	38	50	50	160	160	160	160
TEE42LR	42	G 1 1/2A	38	52	50	160	160	160	160
TEE06SR	6	G 1/4A	15	23	14	315	315	315	315
TEE08SR	8	G 1/4A	17	27	19	315	315	315	315
TEE10SR	10	G 3/8A	18	29	19	250	250	250	250
TEE12SR	12	G 3/8A	22	29	22	250	250	250	250
TEE16SR	16	G 1/2A	25	36	27	250	250	250	250
TEE20SR	20	G 3/4A	28	39	30	250	250	250	250
TEE25SR	25	G 1A	30	44	36	250	250	250	250
TEE30SR	30	G 1 1/4A	36	49	50	160	160	160	160
TEE38SR	38	G 1 1/2A	34	55	50	160	160	160	160

For EO-2 part number, insert "Z" between size and pressure series.
Example: TEE06ZLRFCF

Dimensions and pressures for reference only, subject to change.



TEE-M

Adjustable Locknut Branch Tee
24° Flareless / Metric ORR

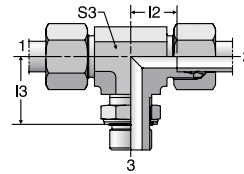


TABLE
OF
CONTENTS

VISUAL
INDEX

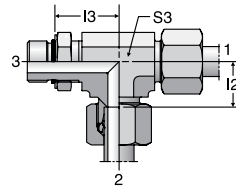
E

TUBE FITTING PART #	END SIZE		I 2 (mm)	I 3 (mm)	S3 (mm)	Pressure Rating (bar)			
	1&2 (mm)	3 Metric				EO		EO-2	
						CF	71	CF	71
TEE06LM	6	M10x1	14	20	14	315	315	315	315
TEE08LM	8	M12x1.5	16	22	14	315	315	315	315
TEE10LM	10	M14x1.5	17	25	19	315	315	315	315
TEE12LM	12	M16x1.5	19	26	19	315	315	315	315
TEE15LM	15	M18x1.5	21	30	22	315	315	315	315
TEE18LM	18	M22x1.5	24	33	27	250	250	250	250
TEE22LM27X2	22	M27x2	28	35	30	160	160	160	160
TEE28LM	28	M33x2	31	38	36	160	160	160	160
TEE35LM	35	M42x2	38	48	50	160	160	160	160
TEE42LM	42	M48x2	38	49	50	160	160	160	160
TEE06SM	6	M12x1.5	15	22	14	315	315	315	315
TEE08SM	8	M14x1.5	17	26	19	315	315	315	315
TEE10SM	10	M16x1.5	18	27	19	315	315	315	315
TEE12SM	12	M18x1.5	22	31	22	315	315	315	315
TEE16SM	16	M22x1.5	25	35	27	250	250	250	250
TEE20SM	20	M27x2	28	39	30	250	250	250	250
TEE25SM	25	M33x2	30	44	36	160	160	160	160
TEE30SM	30	M42x2	36	51	50	160	160	160	160
TEE38SM	38	M48x2	34	54	50	160	160	160	160

For EO-2 part number, insert "Z" between size and pressure series.
Example: TEE06ZLMCF

LEE-UNF

Adjustable Locknut Run Tee
24° Flareless / SAE-ORB



TUBE FITTING PART #	END SIZE		I 2 (mm)	I 3 (mm)	S3 (mm)	Pressure Rating (bar)			
	1 & 2 (mm)	3 UN/UNF-2A				EO		EO-2	
						CF	71	CF	71
LEE06L7/16UNF	6	7/16-20	14	19	14	315	315	315	315
LEE08L7/16UNF	8	7/16-20	16	19	14	315	315	315	315
LEE10L9/16UNF	10	9/16-18	17	24	19	315	315	315	315
LEE12L9/16UNF	12	9/16-18	19	25	19	315	315	315	315
LEE12L3/4UNF	12	3/4-16	19	25	19	315	315	315	315
LEE15L3/4UNF	15	3/4-16	21	28	22	315	315	315	315
LEE15L7/8UNF	15	7/8-14	21	28	22	315	315	315	315
LEE18L7/8UNF	18	7/8-14	24	32	27	315	315	315	315
LEE18L11/16UN	18	1 1/16-12	24	32	30	315	315	315	315
LEE22L11/16UN	22	1 1/16-12	28	35	30	160	160	160	160
LEE28L15/16UN	28	1 5/16-12	31	42	36	160	160	160	160
LEE35L15/8UN	35	1 5/8-12	38	46	50	160	160	160	160
LEE42L17/8UN	42	1 7/8-12	38	47	50	160	160	160	160
LEE06S7/16UNF	6	7/16-20	15	20	14	400	400	400	400
LEE08S9/16UNF	8	9/16-18	17	25	19	400	400	400	400
LEE10S9/16UNF	10	9/16-18	18	26	19	400	400	400	400
LEE12S3/4UNF	12	3/4-16	22	30	22	400	400	400	400
LEE16S7/8UNF	16	7/8-14	25	34	27	400	400	400	400
LEE20S11/16UN	20	1 1/16-12	28	37	30	400	400	400	400
LEE25S11/16UN	25	1 1/16-12	30	50	36	400	400	400	400
LEE30S15/8UN	30	1 5/8-12	36	50	50	250	250	250	250
LEE38S17/8UN	38	1 7/8-12	34	51	50	250	250	250	250

For EO-2 part number, insert "Z" between size and pressure series.
Example: LEE06ZL7/16UNFCF

Dimensions and pressures for reference only, subject to change.

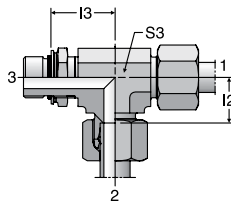


TABLE
OF
CONTENTS

VISUAL
INDEX

LEE-OR

Adjustable Locknut Run Tee
24° Flareless / Metric ISO 6149

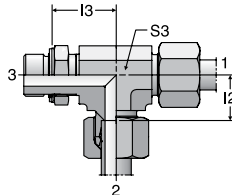


TUBE FITTING PART #	END SIZE		I 2 (mm)	I 3 (mm)	S 3 (mm)	Pressure Rating (bar)			
	1 & 2 (mm)	3 Metric				EO		EO-2	
						CF	71	CF	71
LEE06LMOR	6	M10 x 1	14	20	14	315	315	315	315
LEE08LMOR	8	M12 x 1.5	16	22	14	315	315	315	315
LEE10LMOR	10	M14 x 1.5	17	25	19	315	315	315	315
LEE12LMOR	12	M16 x 1.5	19	26	19	315	315	315	315
LEE15LMOR	15	M18 x 1.5	21	30	22	315	315	315	315
LEE18LMOR	18	M22 x 1.5	24	33	27	315	315	315	315
LEE22LM27x2OR	22	M27 x 2	28	35	30	160	160	160	160
LEE28LMOR	28	M33 x 2	31	38	36	160	160	160	160
LEE35LMOR	35	M42 x 2	38	48	50	160	160	160	160
LEE42LMOR	42	M48 x 2	38	49	50	160	160	160	160
LEE06SMOR	6	M12 x 1.5	15	22	14	400	400	400	400
LEE08SMOR	8	M14 x 1.5	17	26	19	400	400	400	400
LEE10SMOR	10	M16 x 1.5	18	27	19	400	400	400	400
LEE12SMOR	12	M18 x 1.5	22	31	22	400	400	400	400
LEE16SMOR	16	M22 x 1.5	25	35	27	400	400	400	400
LEE20SMOR	20	M27 x 2	28	35	30	400	400	400	400
LEE25SMOR	25	M33 x 2	30	44	36	315	315	315	315
LEE30SMOR	30	M42 x 2	36	51	50	250	250	250	250
LEE38SMOR	38	M48 x 2	34	54	50	200	200	200	200

For EO-2 part number, insert "Z" between size and pressure series.
Example: LEE06ZLMORCF

LEE-R

Adjustable Locknut Run Tee
24° Flareless / BSPP ORR

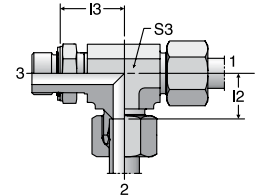


TUBE FITTING PART #	END SIZE		I 2 (mm)	I 3 (mm)	S 3 (mm)	Pressure Rating (bar)			
	1 & 2 (mm)	3 BSPP				EO		EO-2	
						CF	71	CF	71
LEE06LR	6	G 1/8A	14	19	14	315	315	315	315
LEE08LR	8	G 1/4A	16	23	14	315	315	315	315
LEE10LR	10	G 1/4A	17	25	19	315	315	315	315
LEE12LR	12	G 3/8A	19	28	19	250	250	250	250
LEE15LR	15	G 1/2A	21	30	22	250	250	250	250
LEE18LR	18	G 1/2A	24	36	27	250	250	250	250
LEE22LR	22	G 3/4A	28	36	30	160	160	160	160
LEE28LR	28	G 1A	31	44	36	160	160	160	160
LEE35LR	35	G 1 1/4A	38	50	50	160	160	160	160
LEE42LR	42	G 1 1/2A	38	52	50	160	160	160	160
LEE06SR	6	G 1/4A	15	23	14	315	315	315	315
LEE08SR	8	G 1/4A	17	27	19	315	315	315	315
LEE10SR	10	G 3/8A	18	29	19	250	250	250	250
LEE12SR	12	G 3/8A	22	29	22	250	250	250	250
LEE16SR	16	G 1/2A	25	36	27	250	250	250	250
LEE20SR	20	G 3/4A	28	39	30	250	250	250	250
LEE25SR	25	G 1A	30	44	36	250	250	250	250
LEE30SR	30	G 1 1/4A	36	49	50	160	160	160	160
LEE38SR	38	G 1 1/2A	34	55	50	160	160	160	160

For EO-2 part number, insert "Z" between size and pressure series.
Example: LEE06ZLRFCF

LEE-M

Adjustable Locknut Run Tee
24° Flareless / Metric ORR



TUBE FITTING PART #	END SIZE		I 2 (mm)	I 3 (mm)	S 3 (mm)	Pressure Rating (bar)			
	1 & 2 (mm)	3 Metric				EO		EO-2	
						CF	71	CF	71
LEE06LM	6	M10 x 1	14	20	14	315	315	315	315
LEE08LM	8	M12 x 1.5	16	22	14	315	315	315	315
LEE10LM	10	M14 x 1.5	17	25	19	315	315	315	315
LEE12LM	12	M16 x 1.5	19	26	19	315	315	315	315
LEE15LM	15	M18 x 1.5	21	30	22	315	315	315	315
LEE18LM	18	M22 x 1.5	24	33	27	250	250	250	250
LEE22LM27X2	22	M27 x 2	28	35	30	160	160	160	160
LEE28LM	28	M33 x 2	31	38	36	160	160	160	160
LEE35LM	35	M42 x 2	38	48	50	160	160	160	160
LEE42LM	42	M48 x 2	38	49	50	160	160	160	160
LEE06SM	6	M12 x 1.5	15	22	14	315	315	315	315
LEE08SM	8	M14 x 1.5	17	26	19	315	315	315	315
LEE10SM	10	M16 x 1.5	18	27	19	315	315	315	315
LEE12SM	12	M18 x 1.5	22	31	22	315	315	315	315
LEE16SM	16	M22 x 1.5	25	35	27	250	250	250	250
LEE20SM	20	M27 x 2	28	39	30	250	250	250	250
LEE25SM	25	M33 x 2	30	44	36	160	160	160	160
LEE30SM	30	M42 x 2	36	51	50	160	160	160	160
LEE38SM	38	M48 x 2	34	54	50	160	160	160	160

For EO-2 part number, insert "Z" between size and pressure series.
Example: LEE06ZLMCF

Dimensions and pressures for reference only, subject to change.



ET

Swivel Nut Branch Tee
24° Flareless / 24° Flareless /
Flareless Swivel

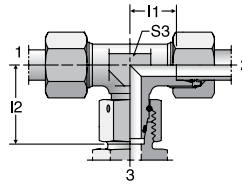


TABLE
OF
CONTENTS

VISUAL
INDEX

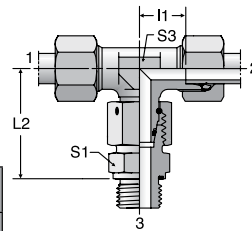
E

TUBE FITTING PART #	END SIZE		I 1 (mm)	I 2 (mm)	S3 (mm)	Pressure Rating (bar)			
	1 & 2 (mm)	3 Metric				EO		EO-2	
						CF	71	CF	71
ET06L	6	M12 x 1.5	12.0	26.0	12	500	315	500	315
ET08L	8	M14 x 1.5	14.0	27.5	12	500	315	500	315
ET10L	10	M16 x 1.5	15.0	29.0	14	500	315	500	315
ET12L	12	M18 x 1.5	17.0	29.5	17	400	315	400	315
ET15L	15	M22 x 1.5	21.0	32.5	19	400	315	400	315
ET18L	18	M26 x 1.5	23.5	35.5	24	400	315	400	315
ET22L	22	M30 x 2	27.5	38.5	27	250	160	250	160
ET28L	28	M36 x 2	30.5	41.5	36	250	160	250	160
ET35L	35	M45 x 2	34.5	51.0	41	250	160	250	160
ET42L	42	M52 x 2	40.0	56.0	50	250	160	250	160
ET06S	6	M14 x 1.5	16.0	27.0	12	800	630	800	630
ET08S	8	M16 x 1.5	17.0	27.5	14	800	630	800	630
ET10S	10	M18 x 1.5	17.5	30.0	17	800	630	800	630
ET12S	12	M20 x 1.5	21.5	31.0	17	630	630	630	630
ET14S	14	M22 x 1.5	22.0	35.0	19	630	630	630	630
ET16S	16	M24 x 1.5	24.5	36.5	24	630	400	630	400
ET20S	20	M30 x 2	26.5	44.5	27	420	400	420	400
ET25S	25	M36 x 2	30.0	50.0	36	420	400	420	400
ET30S	30	M42 x 2	35.5	55.0	41	420	400	420	400
ET38S	38	M52 x 2	41.0	63.0	50	420	315	420	315

For EO-2 part number, insert "Z" between size and pressure series.
Example: ET06ZLCF

ET-R-ED

Assembled Adjustable Swivel Branch Tee
24° Flareless / 24° Flareless /
BSPB with EOlastic Seal



TUBE FITTING PART #	END SIZE		I 1 (mm)	L2 (mm)	S1 (mm)	S3 (mm)	Pressure Rating (bar)			
	1 & 2 (mm)	3 BSPB					EO		EO-2	
							CF	71	CF	71
ET06LRED	6	G 1/8 A	12.0	34.5	14	12	500	315	500	315
ET08LRED	8	G 1/4 A	14.0	37.5	19	12	500	315	500	315
ET10LRED	10	G 1/4 A	15.0	40.0	19	14	500	315	500	315
ET12LRED	12	G 3/8 A	17.0	42.0	22	17	400	315	400	315
ET15LRED	15	G 1/2 A	21.0	46.5	27	19	400	315	400	315
ET18LRED	18	G 1/2 A	23.5	50.0	27	24	400	315	400	315
ET22LRED	22	G 3/4 A	27.5	55.0	32	27	250	160	250	160
ET28LRED	28	G 1 A	30.5	59.0	41	36	250	160	250	160
ET35LRED	35	G 1 1/4 A	34.5	68.5	50	41	250	160	250	160
ET42LRED	42	G 1 1/2 A	40.0	75.0	55	50	250	160	250	160
ET06SRED	6	G 1/4 A	16.0	40.0	19	12	800	630	800	630
ET08SRED	8	G 1/4 A	17.0	42.5	19	14	800	630	800	630
ET10SRED	10	G 3/8 A	17.5	45.0	22	17	800	630	800	630
ET12SRED	12	G 3/8 A	21.5	48.0	22	17	630	630	630	630
ET14SRED	14	G 1/2 A	22.0	54.0	27	19	630	630	630	630
ET16SRED	16	G 1/2 A	24.5	55.0	27	24	630	400	630	400
ET20SRED	20	G 3/4 A	26.5	65.0	32	27	420	400	420	400
ET25SRED	25	G 1 A	30.0	73.0	41	36	420	400	420	400
ET30SRED	30	G 1 1/4 A	35.5	78.5	50	41	420	400	420	400
ET38SRED	38	G 1 1/2 A	41.0	89.0	55	50	420	315	420	315

For EO-2 part number, insert "Z" between size and pressure series.
Example: ET06ZLREDCF

Dimensions and pressures for reference only, subject to change.



ET-M-ED

Assembled Adjustable Swivel Branch Tee
24° Flareless / 24° Flareless /
Metric Parallel with EOlastic Seal

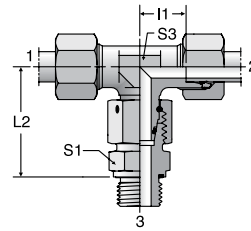


TABLE
OF
CONTENTS

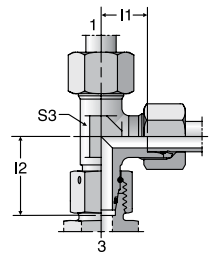
VISUAL
INDEX

TUBE FITTING PART #	END SIZE		I 1 (mm)	L 2 (mm)	S 1 (mm)	S 3 (mm)	Pressure Rating (bar)			
	1 & 2 (mm)	3 Metric					EO		EO-2	
							CF	71	CF	71
ET06LMED	6	M10 x 1	12.0	34.5	14	12	500	315	500	315
ET08LMED	8	M12 x 1.5	14.0	37.5	17	12	500	315	500	315
ET10LMED	10	M14 x 1.5	15.0	40.0	19	14	500	315	500	315
ET12LMED	12	M16 x 1.5	17.0	42.0	22	17	400	315	400	315
ET15LMED	15	M18 x 1.5	21.0	46.0	24	19	400	315	400	315
ET18LMED	18	M22 x 1.5	23.5	50.0	27	24	400	315	400	315
ET22LMED	22	M26 x 1.5	27.5	55.0	32	27	250	160	250	160
ET28LMED	28	M33 x 2	30.5	59.0	41	36	250	160	250	160
ET35LMED	35	M42 x 2	34.5	68.5	50	41	250	160	250	160
ET42LMED	42	M48 x 2	40.0	75.0	55	50	250	160	250	160
ET06SMED	6	M12 x 1.5	16.0	40.0	17	12	800	630	800	630
ET08SMED	8	M14 x 1.5	17.0	42.5	19	14	800	630	800	630
ET10SMED	10	M16 x 1.5	17.5	45.0	22	17	800	630	800	630
ET12SMED	12	M18 x 1.5	21.5	48.0	24	17	630	630	630	630
ET14SMED	14	M20 x 1.5	22.0	54.0	27	19	630	630	630	630
ET16SMED	16	M22 x 1.5	24.5	55.0	27	24	630	400	630	400
ET20SMED	20	M27 x 2	26.5	65.0	32	27	420	400	420	400
ET25SMED	25	M33 x 2	30.0	73.0	41	36	420	400	420	400
ET30SMED	30	M42 x 2	35.5	78.5	50	41	420	400	420	400
ET38SMED	38	M48 x 2	41.0	89.0	55	50	420	315	420	315

For EO-2 part number, insert "Z" between size and pressure series.
Example: ET06ZLMEDCF

EL

Swivel Nut Run Tee
24° Flareless / Flareless Swivel



TUBE FITTING PART #	END SIZE		I 1 (mm)	I 2 (mm)	S 3 (mm)	Pressure Rating (bar)			
	1 & 2 (mm)	3 Metric				EO		EO-2	
						CF	71	CF	71
EL06L	6	M12 x 1.5	12.0	26.0	12	500	315	500	315
EL08L	8	M14 x 1.5	14.0	27.5	12	500	315	500	315
EL10L	10	M16 x 1.5	15.0	29.0	14	500	315	500	315
EL12L	12	M18 x 1.5	17.0	29.5	17	400	315	400	315
EL15L	15	M22 x 1.5	21.0	32.5	19	400	315	400	315
EL18L	18	M26 x 1.5	23.5	35.5	24	400	315	400	315
EL22L	22	M30 x 2	27.5	38.5	27	250	160	250	160
EL28L	28	M36 x 2	30.5	41.5	36	250	160	250	160
EL35L	35	M45 x 2	34.5	51.0	41	250	160	250	160
EL42L	42	M52 x 2	40.0	56.0	50	250	160	250	160
EL06S	6	M14 x 1.5	16.0	27.0	12	800	630	800	630
EL08S	8	M16 x 1.5	17.0	27.5	14	800	630	800	630
EL10S	10	M18 x 1.5	17.5	30.0	17	800	630	800	630
EL12S	12	M20 x 1.5	21.5	31.0	17	630	630	630	630
EL14S	14	M22 x 1.5	22.0	35.0	19	630	630	630	630
EL16S	16	M24 x 1.5	24.5	36.5	24	630	400	630	400
EL20S	20	M30 x 2	26.5	44.5	27	420	400	420	400
EL25S	25	M36 x 2	30.0	50.0	36	420	400	420	400
EL30S	30	M42 x 2	35.5	55.0	41	420	400	420	400
EL38S	38	M52 x 2	41.0	63.0	50	420	315	420	315

For EO-2 part number, insert "Z" between size and pressure series.
Example: EL06ZLCF

Dimensions and pressures for reference only, subject to change.



EL-R-ED

Adjustable Assembled Swivel Run Tee
24° Flareless / BSPP with EOlastic Seal

TUBE FITTING PART #	END SIZE		I 1 (mm)	I 2 (mm)	L 2 (mm)	S 1 (mm)	S 3 (mm)	Pressure Rating (bar)			
	1 & 2 (mm)	3 BSPP						EO		EO-2	
								CF	71	CF	71
EL06LRED	6	G 1/8 A	12.0	34.5	61	14	12	500	315	500	315
EL08LRED	8	G 1/4 A	14.0	37.5	66	19	12	500	315	500	315
EL10LRED	10	G 1/4 A	15.0	40.0	70	19	14	500	315	500	315
EL12LRED	12	G 3/8 A	17.0	42.0	74	22	17	400	315	400	315
EL15LRED	15	G 1/2 A	21.0	46.5	83	27	19	400	315	400	315
EL18LRED	18	G 1/2 A	23.5	50.0	90	27	24	400	315	400	315
EL22LRED	22	G 3/4 A	27.5	55.0	99	32	27	250	160	250	160
EL28LRED	28	G 1 A	30.5	59.0	106	41	36	250	160	250	160
EL35LRED	35	G 1 1/4 A	34.5	68.5	125	50	41	250	160	250	160
EL42LRED	42	G 1 1/2 A	40.0	75.0	138	55	50	250	160	250	160
EL06SRED	6	G 1/4 A	16.0	40.0	71	19	12	800	630	800	630
EL08SRED	8	G 1/4 A	17.0	42.5	74	19	14	800	630	800	630
EL10SRED	10	G 3/8 A	17.5	45.0	79	22	17	800	630	800	630
EL12SRED	12	G 3/8 A	21.5	48.0	86	22	17	630	630	630	630
EL14SRED	14	G 1/2 A	22.0	54.0	94	27	19	630	630	630	630
EL16SRED	16	G 1/2 A	24.5	55.0	98	27	24	630	400	630	400
EL20SRED	20	G 3/4 A	26.5	65.0	113	32	27	420	400	420	400
EL25SRED	25	G 1 A	30.0	73.0	127	41	36	420	400	420	400
EL30SRED	30	G 1 1/4 A	35.5	78.5	141	50	41	420	400	420	400
EL38SRED	38	G 1 1/2 A	41.0	89.0	161	55	50	420	315	420	315

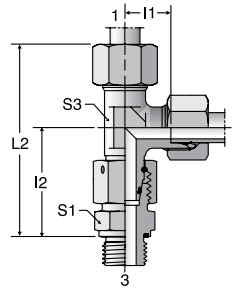


TABLE OF CONTENTS

VISUAL INDEX

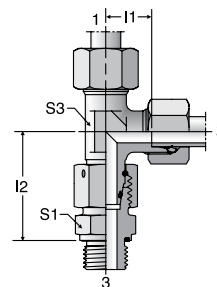
E

For EO-2 part number, insert "Z" between size and pressure series.
Example: EL06ZLREDCF

EL-M-ED

Adjustable Assembled Swivel Run Tee
24° Flareless / Metric Parallel with EOlastic Seal

TUBE FITTING PART #	END SIZE		I 1 (mm)	I 2 (mm)	S 1 (mm)	S 3 (mm)	Pressure Rating (bar)			
	1 & 2 (mm)	3 Metric					EO		EO-2	
							CF	71	CF	71
EL06LMED	6	M10 x 1	12.0	34.5	14	12	500	315	500	315
EL08LMED	8	M12 x 1.5	14.0	37.5	17	12	500	315	500	315
EL10LMED	10	M14 x 1.5	15.0	40.0	19	14	500	315	500	315
EL12LMED	12	M16 x 1.5	17.0	42.0	22	17	400	315	400	315
EL15LMED	15	M18 x 1.5	21.0	46.0	24	19	400	315	400	315
EL18LMED	18	M22 x 1.5	23.5	50.0	27	24	400	315	400	315
EL22LMED	22	M26 x 1.5	27.5	55.0	32	27	250	160	250	160
EL28LMED	28	M33 x 2	30.5	59.0	41	36	250	160	250	160
EL35LMED	35	M42 x 2	34.5	68.5	50	41	250	160	250	160
EL42LMED	42	M48 x 2	40.0	75.0	55	50	250	160	250	160
EL06SMED	6	M12 x 1.5	16.0	40.0	17	12	800	630	800	630
EL08SMED	8	M14 x 1.5	17.0	42.5	19	14	800	630	800	630
EL10SMED	10	M16 x 1.5	17.5	45.0	22	17	800	630	800	630
EL12SMED	12	M18 x 1.5	21.5	48.0	24	17	630	630	630	630
EL14SMED	14	M20 x 1.5	22.0	54.0	27	19	630	630	630	630
EL16SMED	16	M22 x 1.5	24.5	55.0	27	24	630	400	630	400
EL20SMED	20	M27 x 2	26.5	65.0	32	27	420	400	420	400
EL25SMED	25	M33 x 2	30.0	73.0	41	36	420	400	420	400
EL30SMED	30	M42 x 2	35.5	78.5	50	41	420	400	420	400
EL38SMED	38	M48 x 2	41.0	89.0	55	50	420	315	420	315



For EO-2 part number, insert "Z" between size and pressure series.
Example: EL06ZLMEDCF

Dimensions and pressures for reference only, subject to change.



TH-R

High Pressure Banjo Tee
24° Flareless / 24° Flareless / BSPP

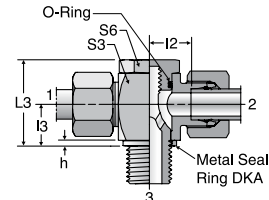


TABLE OF CONTENTS

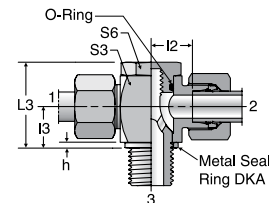
VISUAL INDEX

TUBE FITTING PART #	END SIZE		h (mm)	I2 (mm)	I3 (mm)	L3 (mm)	S3 (mm)	S6 (mm)	Pressure Rating (bar)			
	1 & 2 (mm)	3 BSPP							EO		EO-2	
									CF	71	CF	71
TH06LR	6	G 1/8 A	2.5	12.0	10.5	24	17	17	250	250	250	250
TH08LR	8	G 1/4 A	3.0	14.5	14.0	30	22	19	250	250	250	250
TH10LR	10	G 1/4 A	3.0	15.5	14.0	30	22	19	250	250	250	250
TH12LR	12	G 3/8 A	3.0	18.0	16.5	36	27	24	250	250	250	250
TH15LR	15	G 1/2 A	4.5	21.5	21.5	45	32	30	250	250	250	250
TH18LR	18	G 1/2 A	4.5	21.0	21.5	45	32	30	250	250	250	250
TH22LR	22	G 3/4 A	3.5	27.5	24.0	53	41	36	160	160	160	160
TH28LR	28	G 1 A	3.5	32.0	30.5	66	50	46	160	160	160	160
TH35LR	35	G 1 1/4 A	3.5	36.0	35.5	76	60	55	160	160	160	160
TH42LR	42	G 1 1/2 A	3.5	40.5	40.5	87	70	60	160	160	160	160
TH06SR	6	G 1/4 A	3.0	16.5	14.0	30	22	19	315	315	315	315
TH08SR	8	G 1/4 A	3.0	16.5	14.0	30	22	19	315	315	315	315
TH10SR	10	G 3/8 A	3.0	18.5	16.5	36	27	24	315	315	315	315
TH12SR	12	G 3/8 A	3.0	18.5	16.5	36	27	24	315	315	315	315
TH14SR	14	G 1/2 A	4.5	22.5	21.5	45	32	30	315	315	315	315
TH16SR	16	G 1/2 A	4.5	22.0	21.5	45	32	30	315	315	315	315
TH20SR	20	G 3/4 A	3.5	26.5	24.0	53	41	36	160	160	160	160
TH25SR	25	G 1 A	3.5	31.5	30.5	66	50	46	160	160	160	160
TH30SR	30	G 1 1/4 A	3.5	37.0	35.5	76	60	55	160	160	160	160
TH38SR	38	G 1 1/2 A	3.5	41.5	40.5	87	70	60	160	160	160	160

For EO-2 part number, insert "Z" between size and pressure series.
Example: TH06ZLRFC

TH-M

High Pressure Banjo Tee
24° Flareless / 24° Flareless / Metric Parallel



TUBE FITTING PART #	END SIZE		h (mm)	I2 (mm)	I3 (mm)	L3 (mm)	S3 (mm)	S6 (mm)	Pressure Rating (bar)			
	1 & 2 (mm)	3 Metric							EO		EO-2	
									CF	71	CF	71
TH06LM	6	M10 x 1	2.5	12.0	10.5	24.0	17	17	250	250	250	250
TH08LM	8	M12 x 1.5	3.0	14.5	14.0	30.0	22	19	250	250	250	250
TH10LM	10	M14 x 1.5	3.0	15.5	14.0	30.0	22	19	250	250	250	250
TH12LM	12	M16 x 1.5	3.0	18.0	16.5	36.0	27	24	250	250	250	250
TH15LM	15	M18 x 1.5	3.0	21.5	18.5	39.5	30	27	250	250	250	250
TH18LM	18	M22 x 1.5	4.5	21.0	21.5	45.0	32	30	250	250	250	250
TH22LM	22	M26 x 1.5	3.5	27.5	24.0	53.0	41	36	160	160	160	160
TH28LM	28	M33 x 2	3.5	32.0	30.5	66.0	50	46	160	160	160	160
TH35LM	35	M42 x 2	3.5	36.0	35.5	76.0	60	55	160	160	160	160
TH42LM	42	M48 x 2	3.5	40.5	40.5	87.0	70	60	160	160	160	160
TH06SM	6	M12 x 1.5	3.0	16.5	14.0	30.0	22	19	315	315	315	315
TH08SM	8	M14 x 1.5	3.0	16.5	14.0	30.0	22	19	315	315	315	315
TH10SM	10	M16 x 1.5	3.0	18.5	16.5	36.0	27	24	315	315	315	315
TH12SM	12	M18 x 1.5	3.0	20.0	18.5	39.5	27	27	315	315	315	315
TH14SM	14	M20 x 1.5	3.0	22.5	20.0	43.5	32	30	315	315	315	315
TH16SM	16	M22 x 1.5	4.5	22.0	21.5	45.0	32	30	315	315	315	315
TH20SM	20	M27 x 2	3.5	26.5	24.0	53.0	41	36	160	160	160	160
TH25SM	25	M33 x 2	3.5	31.5	30.5	66.0	50	46	160	160	160	160
TH30SM	30	M42 x 2	3.5	37.0	35.5	76.0	60	55	160	160	160	160
TH38SM	38	M48 x 2	3.5	41.5	40.5	87.0	70	60	160	160	160	160

For EO-2 part number, insert "Z" between size and pressure series.
Example: TH06ZLMCF

Dimensions and pressures for reference only, subject to change.



TH-R-KDS

High Pressure Banjo Tee

24° Flareless / 24° Flareless / BSPP

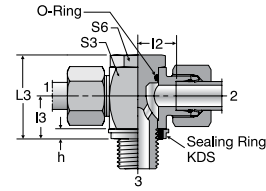


TABLE OF CONTENTS

VISUAL INDEX

E

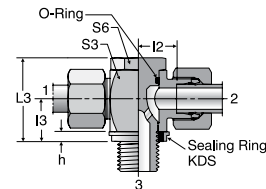
TUBE FITTING PART #	END SIZE		h (mm)	I2 (mm)	I3 (mm)	L3 (mm)	S3 (mm)	S6 (mm)	Pressure Rating (bar)			
	1 & 2 (mm)	3 BSPP							EO		EO-2	
									CF	71	CF	71
TH06LRKDS	6	G 1/8 A	2.5	12.0	10.5	24	17	17	315	315	315	315
TH08LRKDS	8	G 1/4 A	3.0	14.5	14.0	30	22	19	315	315	315	315
TH10LRKDS	10	G 1/4 A	3.0	15.5	14.0	30	22	19	315	315	315	315
TH12LRKDS	12	G 3/8 A	3.0	18.0	16.5	36	27	24	315	315	315	315
TH15LRKDS	15	G 1/2 A	4.5	21.5	21.5	45	32	30	315	315	315	315
TH18LRKDS	18	G 1/2 A	4.5	21.0	21.5	45	32	30	315	315	315	315
TH22LRKDS	22	G 3/4 A	3.5	27.5	24.0	53	41	36	160	160	160	160
TH28LRKDS	28	G 1 A	3.5	32.0	30.5	66	50	46	160	160	160	160
TH35LRKDS	35	G 1 1/4 A	3.5	36.0	35.5	76	60	55	160	160	160	160
TH42LRKDS	42	G 1 1/2 A	3.5	40.5	40.5	87	70	60	160	160	160	160
TH06SRKDS	6	G 1/4 A	3.0	16.5	14.0	30	22	19	400	400	400	400
TH08SRKDS	8	G 1/4 A	3.0	16.5	14.0	30	22	19	400	400	400	400
TH10SRKDS	10	G 3/8 A	3.0	18.5	16.5	36	27	24	400	400	400	400
TH12SRKDS	12	G 3/8 A	3.0	18.5	16.5	36	27	24	400	400	400	400
TH14SRKDS	14	G 1/2 A	4.5	22.5	21.5	45	32	30	400	400	400	400
TH16SRKDS	16	G 1/2 A	4.5	22.0	21.5	45	32	30	315	315	315	315
TH20SRKDS	20	G 3/4 A	3.5	26.5	24.0	53	41	36	315	315	315	315
TH25SRKDS	25	G 1 A	3.5	31.5	30.5	66	50	46	250	250	250	250
TH30SRKDS	30	G 1 1/4 A	3.5	37.0	35.5	76	60	55	160	160	160	160
TH38SRKDS	38	G 1 1/2 A	3.5	41.5	40.5	87	70	60	160	160	160	160

For EO-2 part number, insert "Z" between size and pressure series.
Example: TH06ZLRKDSCF

TH-M-KDS

High Pressure Banjo Tee

24° Flareless / 24° Flareless / Metric Parallel



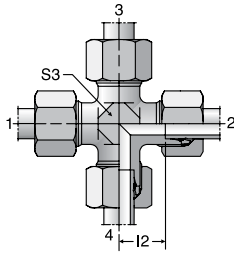
TUBE FITTING PART #	END SIZE		h (mm)	I2 (mm)	I3 (mm)	L3 (mm)	S3 (mm)	S6 (mm)	Pressure Rating (bar)			
	1 & 2 (mm)	3 Metric							EO		EO-2	
									CF	71	CF	71
TH06LMKDS	6	M10 x 1	2.5	12.0	10.5	24	17	17	315	315	315	315
TH08LMKDS	8	M12 x 1.5	3.0	14.5	14.0	30	22	19	315	315	315	315
TH10LMKDS	10	M14 x 1.5	3.0	15.5	14.0	30	22	19	315	315	315	315
TH12LMKDS	12	M16 x 1.5	3.0	18.0	16.5	36	27	24	315	315	315	315
TH15LMKDS	15	M18 x 1.5	3.0	21.5	18.5	39.5	30	27	315	315	315	315
TH18LMKDS	18	M22 x 1.5	4.5	21.0	21.5	45	32	30	315	315	315	315
TH22LMKDS	22	M26 x 1.5	3.5	27.5	24.0	53	41	36	160	160	160	160
TH28LMKDS	28	M33 x 2	3.5	32.0	30.5	66	50	46	160	160	160	160
TH35LMKDS	35	M42 x 2	3.5	36.0	35.5	76	60	55	160	160	160	160
TH42LMKDS	42	M48 x 2	3.5	40.5	40.5	87	70	60	160	160	160	160
TH06SMKDS	6	M12 x 1.5	3.0	16.5	14.0	30	22	19	400	400	400	400
TH08SMKDS	8	M14 x 1.5	3.0	16.5	14.0	30	22	19	400	400	400	400
TH10SMKDS	10	M16 x 1.5	3.0	18.5	16.5	36	27	24	400	400	400	400
TH12SMKDS	12	M18 x 1.5	3.0	20.0	18.5	39.5	27	27	400	400	400	400
TH14SMKDS	14	M20 x 1.5	3.0	22.5	20.0	43.5	32	30	400	400	400	400
TH16SMKDS	16	M22 x 1.5	4.5	22.0	21.5	45	32	30	315	315	315	315
TH20SMKDS	20	M27 x 2	3.5	26.5	24.0	53	41	36	315	315	315	315
TH25SMKDS	25	M33 x 2	3.5	31.5	30.5	66	50	46	250	250	250	250
TH30SMKDS	30	M42 x 2	3.5	37.0	35.5	76	60	55	160	160	160	160
TH38SMKDS	38	M48 x 2	3.5	41.5	40.5	87	70	60	160	160	160	160

For EO-2 part number, insert "Z" between size and pressure series.
Example: TH06ZLMKDSCF

Dimensions and pressures for reference only, subject to change.



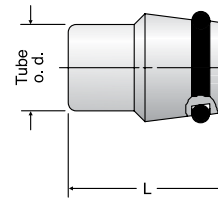
K
Union Cross
24° Flareless



TUBE FITTING PART #	END SIZE 1-4 (mm)	I 2 (mm)	S3 (mm)	Pressure Rating (bar)							
				EO			EO-2				
				CF	71	MS	CF	71			
K04LL	4	11.0	9	100	100	63	100	100			
K06LL	6	9.5	9	100	100	63	100	100			
K08LL	8	11.5	12	100	100	63	100	100			
K06L	6	12.0	12	315	315	200	315	315			
K08L	8	14.0	12	315	315	200	315	315			
K10L	10	15.0	14	315	315	200	315	315			
K12L	12	17.0	17	315	315	200	315	315			
K15L	15	21.0	19	315	315	200	315	315			
K18L	18	23.5	24	315	315	200	315	315			
K22L	22	27.5	27	160	160	100	160	160			
K28L	28	30.5	36	160	160	100	160	160			
K35L	35	34.5	41	160	160	100	160	160			
K42L	42	40.0	50	160	160	100	160	160			
K06S	6	16.0	12	630	630	400	630	630			
K08S	8	17.0	14	630	630	400	630	630			
K10S	10	17.5	17	630	630	400	630	630			
K12S	12	21.5	17	630	630	400	630	630			
K14S	14	22.0	19	400	400	250	400	400			
K16S	16	24.5	24	400	400	250	400	400			
K20S	20	26.5	27	315	315	200	315	315			
K25S	25	30.0	36	315	315	200	315	315			
K30S	30	35.5	41	315	315	200	315	315			
K38S	38	41.0	50	315	315	200	315	315			

For EO-2 part number, insert "Z" between size and pressure series.
Example: K06ZLCF

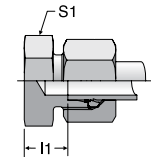
VKA
Cap



TUBE FITTING PART #	TUBE O.D. 1 (mm)	L (mm)	Pressure Rating (bar)		
			EO		
			CF	71	MS
VKA06	6	18.5	500	315	200
VKA08	8	18.5	500	315	200
VKA10	10	20.0	500	315	200
VKA12	12	20.5	400	315	200
VKA15	15	20.5	400	315	200
VKA18	18	22.5	400	315	200
VKA22	22	25.0	250	160	100
VKA28	28	25.5	250	160	100
VKA35	35	30.0	250	160	100
VKA42	42	30.0	250	160	100
VKA06	6	18.5	800	630	400
VKA08	8	18.5	800	630	400
VKA10	10	20.0	800	630	400
VKA12	12	20.5	630	630	400
VKA14	14	22.5	630	630	400
VKA16	16	23.5	630	400	250
VKA20	20	28.5	420	400	250
VKA25	25	29.0	420	400	250
VKA30	30	30.5	420	400	250
VKA38	38	33.0	420	315	200

Note: Part does not include tube nut.
Sizes 6,8,10 & 12 work with L and S Series.

ROV
Plug
24° Flareless



TUBE FITTING PART #	END SIZE 1 (mm)	I 1 (mm)	S1 (mm)	Pressure Rating (bar)			
				EO		EO-2	
				CF	71	CF	71
ROV06L	6	7	12	315	315	315	315
ROV08L	8	8	14	315	315	315	315
ROV10L	10	9	17	315	315	315	315
ROV12L	12	10.0	19	315	315	315	315
ROV15L	15	11.0	24	315	315	315	315
ROV18L	18	11.5	27	315	315	315	315
ROV22L	22	13.5	32	160	160	160	160
ROV28L	28	14.5	41	160	160	160	160
ROV35L	35	14.5	46	160	160	160	160
ROV42L	42	16.0	55	160	160	160	160
ROV06S	6	11.0	14	630	630	630	630
ROV08S	8	13.0	17	630	630	630	630
ROV10S	10	12.5	19	630	630	630	630
ROV12S	12	14.5	22	630	630	630	630
ROV14S	14	16.0	24	630	630	630	630
ROV16S	16	15.5	27	400	400	400	400
ROV20S	20	17.5	32	400	400	400	400
ROV25S	25	20.0	41	400	400	400	400
ROV30S	30	20.5	46	400	400	400	400
ROV38S	38	23.0	55	315	315	315	315

For EO-2 part number, insert "Z" between size and pressure series.
Example: ROV06ZLCF

Dimensions and pressures for reference only, subject to change.



DVGE-R

Plain Bearing Rotary Straight
24° Flareless / BSPP with EOlastic Seal*

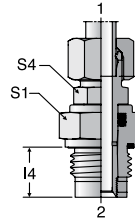


TABLE
OF
CONTENTS

VISUAL
INDEX

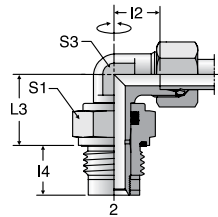
E

TUBE FITTING PART #	END SIZE		I 1 (mm)	I 4 (mm)	S 1 (mm)	S 4 (mm)	Pressure Rating (bar)	
	1 (mm)	2 BSPP					EO	CF
	DVGE06LR	6						
DVGE08LR	8	G 1/4 A	21.0	18.0	19	14	40	
DVGE10LR	10	G 3/8 A	25.0	18.0	24	17	40	
DVGE12LR	12	G 1/2 A	27.0	21.0	27	19	40	
DVGE15LR	15	G 3/4 A	32.0	24.0	32	24	40	
DVGE18LR	18	G 1 A	35.0	27.5	41	27	40	
DVGE22LR	22	G 1 A	39.0	27.5	41	32	40	
DVGE28LR	28	G 1 1/4 A	40.5	31.0	50	41	40	
DVGE35LR	35	G 1 1/2 A	44.5	35.0	55	46	40	
DVGE06SR	6	G 1/4 A	23.0	18.0	19	14	100	
DVGE08SR	8	G 1/4 A	24.0	18.0	19	17	100	
DVGE10SR	10	G 3/8 A	26.5	18.0	24	19	100	
DVGE12SR	12	G 1/2 A	28.5	21.0	27	22	100	
DVGE16SR	16	G 3/4 A	33.5	24.0	32	27	100	
DVGE20SR	20	G 1 A	38.0	27.5	41	32	100	
DVGE25SR	25	G 1 A	40.5	27.5	41	41	100	
DVGE30SR	30	G 1 1/4 A	41.5	31.0	50	46	100	
DVGE38SR	38	G 1 1/2 A	47.0	35.0	55	55	100	

*Note: Port depth must be deeper than standard DIN 3852-2.

DVWE-R

Plain Bearing Rotary Elbow
24° Flareless / BSPP with EOlastic Seal*



TUBE FITTING PART #	END SIZE		I 2 (mm)	I 4 (mm)	L 3 (mm)	S 1 (mm)	S 3 (mm)	Pressure Rating (bar)	
	1 (mm)	2 BSPP						EO	CF
	DVWE06LR	6							
DVWE08LR	8	G 1/4 A	14.0	18.0	21.0	19	12	40	
DVWE10LR	10	G 3/8 A	15.0	18.0	26.0	24	14	40	
DVWE12LR	12	G 1/2 A	17.0	21.0	27.0	27	17	40	
DVWE15LR	15	G 3/4 A	21.0	24.0	33.0	32	19	40	
DVWE18LR	18	G 1 A	23.5	27.5	37.5	41	27	40	
DVWE22LR	22	G 1 A	27.5	27.5	39.5	41	27	40	
DVWE28LR	28	G 1 1/4 A	30.5	31.0	44.0	50	36	40	
DVWE35LR	35	G 1 1/2 A	34.5	35.0	54.0	55	41	40	
DVWE06SR	6	G 1/4 A	16.0	18.0	21.0	19	12	100	
DVWE08SR	8	G 1/4 A	17.0	18.0	22.0	19	14	100	
DVWE10SR	10	G 3/8 A	17.5	18.0	27.0	24	17	100	
DVWE12SR	12	G 1/2 A	21.5	21.0	28.0	27	17	100	
DVWE16SR	16	G 3/4 A	24.5	24.0	34.0	32	24	100	
DVWE20SR	20	G 1 A	26.5	27.5	39.5	41	27	100	
DVWE25SR	25	G 1 A	30.0	27.5	42.5	41	36	100	
DVWE30SR	30	G 1 1/4 A	35.5	31.0	48.0	50	41	100	
DVWE38SR	38	G 1 1/2 A	41.0	35.0	55.0	55	50	100	

*Note: Port depth must be deeper than standard DIN 3852-2.

Dimensions and pressures for reference only, subject to change.

DVGE-M

Plain Bearing Rotary Straight
24° Flareless / Metric Parallel with EOlastic Seal*

TUBE FITTING PART #	END SIZE		I1 (mm)	I4 (mm)	S1 (mm)	S3 (mm)	Pressure Rating (bar)	
	1 (mm)	2 Metric					EO	CF
	DVGE06LM	6						
DVGE08LM	8	M 14 x 1.5	21.0	18.0	19	12	40	
DVGE10LM	10	M 18 x 1.5	26.0	18.0	24	14	40	
DVGE12LM	12	M 22 x 1.5	27.0	21.0	27	17	40	
DVGE15LM	15	M 27 x 2	33.0	24.0	32	19	40	
DVGE18LM	18	M 33 x 2	37.5	27.5	41	27	40	
DVGE22LM	22	M 33 x 2	39.5	27.5	41	27	40	
DVGE28LM	28	M 42 x 2	44.0	31.0	50	36	40	
DVGE35LM	35	M 48 x 2	54.0	35.0	55	41	40	
DVGE06SM	6	M 14 x 1.5	21.0	18.0	19	12	100	
DVGE08SM	8	M 14 x 1.5	22.0	18.0	19	14	100	
DVGE10SM	10	M 18 x 1.5	27.0	18.0	24	17	100	
DVGE12SM	12	M 22 x 1.5	28.0	21.0	27	17	100	
DVGE16SM	16	M 27 x 2	34.0	24.0	32	24	100	
DVGE20SM	20	M 33 x 2	39.5	27.5	41	27	100	
DVGE25SM	25	M 33 x 2	42.5	27.5	41	36	100	
DVGE30SM	30	M 42 x 2	48.0	31.0	50	41	100	
DVGE38SM	38	M 48 x 2	55.0	35.0	55	50	100	

*Note: Port depth must be deeper than standard DIN 3852-1.

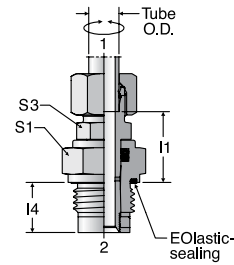


TABLE OF CONTENTS

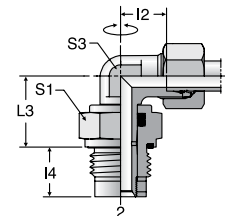
VISUAL INDEX

DVWE-M

Plain Bearing Rotary Elbow
24° Flareless / Metric Parallel with EOlastic Seal*

TUBE FITTING PART #	END SIZE		I2 (mm)	I4 (mm)	L3 (mm)	S1 (mm)	S3 (mm)	Pressure Rating (bar)	
	1 (mm)	2 Metric						EO	CF
	DVWE06LM	6							
DVWE08LM	8	M 14 x 1.5	14.0	18.0	21.0	19	12	40	
DVWE10LM	10	M 18 x 1.5	15.0	18.0	26.0	24	14	40	
DVWE12LM	12	M 22 x 1.5	17.0	21.0	27.0	27	17	40	
DVWE15LM	15	M 27 x 2	21.0	24.0	33.0	32	19	40	
DVWE18LM	18	M 33 x 2	23.5	27.5	37.5	41	27	40	
DVWE22LM	22	M 33 x 2	27.5	27.5	39.5	41	27	40	
DVWE28LM	28	M 42 x 2	30.5	31.0	44.0	50	36	40	
DVWE35LM	35	M 48 x 2	34.5	35.0	54.0	55	41	40	
DVWE06SM	6	M 14 x 1.5	16.0	18.0	21.0	19	12	100	
DVWE08SM	8	M 14 x 1.5	17.0	18.0	22.0	19	14	100	
DVWE10SM	10	M 18 x 1.5	17.5	18.0	27.0	24	17	100	
DVWE12SM	12	M 22 x 1.5	21.5	21.0	28.0	27	17	100	
DVWE16SM	16	M 27 x 2	24.5	24.0	34.0	32	24	100	
DVWE20SM	20	M 33 x 2	26.5	27.5	39.5	41	27	100	
DVWE25SM	25	M 33 x 2	30.0	27.5	42.5	41	36	100	
DVWE30SM	30	M 42 x 2	35.5	31.0	48.0	50	41	100	
DVWE38SM	38	M 48 x 2	41.0	35.0	55.0	55	50	100	

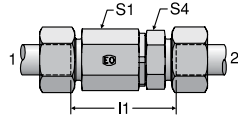
*Note: Port depth must be deeper than standard DIN 3852-1.



Dimensions and pressures for reference only, subject to change.

DG101

Ball Bearing Rotary Union
24° Flareless / 24° Flareless

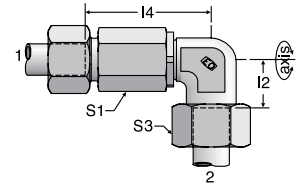


TUBE FITTING PART #	END SIZE		I 1 (mm)	S1 (mm)	S4 (mm)	Pressure Rating (bar)	
	1 & 2 (mm)					EO	CF
	DG101/06S	6				47	22
DG101/08S	8	47	22	17	•		
DG101/12S	12	57	30	24	•		
DG101/16S	16	57	30	27	•		
DG101/20S	20	71	41	36	•		
DG101/25S	25	72	41	41	•		
DG101/30S	30	82	60	46			
DG101/38S	38	82	60	55			

Note: See Table E1 on page E7 for RPM/working pressure data.

DG103

Ball Bearing Rotary Elbow
24° Flareless / 24° Flareless

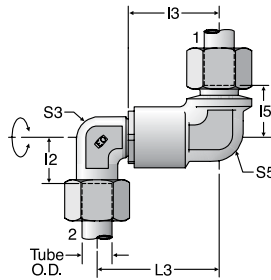


TUBE FITTING PART #	END SIZE		I 2 (mm)	I 4 (mm)	S1 (mm)	S3 (mm)	Pressure Rating (bar)	
	1 & 2 (mm)						EO	CF
	DG103/06S	6					16.0	44.5
DG103/08S	8	17.0	44.5	22	19	•		
DG103/12S	12	21.5	55.5	30	24	•		
DG103/16S	16	24.5	54.5	30	30	•		
DG103/20S	20	26.5	72.5	41	36	•		
DG103/25S	25	30.0	71.0	41	46	•		
DG103/30S	30	35.5	89.0	60	50	•		
DG103/38S	38	41.0	86.5	60	60	•		

Note: See Table E1 on page E7 for RPM/working pressure data.

DG105

Ball Bearing Rotary Union
24° Flareless / 24° Flareless

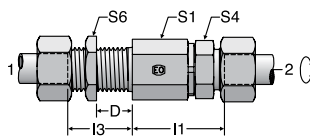


TUBE FITTING PART #	END SIZE		I 2 (mm)	I 3 (mm)	I 5 (mm)	L 3 (mm)	S 3 (mm)	S 5 (mm)	Pressure Rating (bar)	
	1 & 2 (mm)								EO	CF
	DG105/12S	12							21.5	39.5
DG105/16S	16	24.5	39.5	25.5	53.0	22	24	•		
DG105/20S	20	26.5	56.5	39.5	76.0	36	32	•		
DG105/25S	25	30.0	56.5	38.0	76.0	36	32	•		
DG105/30S	30	35.5	65.0	44.5	92.5	50	50	•		
DG105/38S	38	41.0	65.0	42.0	92.5	50	50	•		

Note: See Table E1 on page E7 for RPM/working pressure data.

DG107

Ball Bearing Rotary Bulkhead Union
24° Flareless / 24° Flareless



TUBE FITTING PART #	END SIZE		D (mm)	I 1 (mm)	I 3 (mm)	S 1 (mm)	S 4 (mm)	S 6 (mm)	Pressure Rating (bar)	
	1 & 2 (mm)								EO	CF
	DG107/06S	6							5	42.0
DG107/08S	8	5	42.0	16.0	22	17	22	•		
DG107/12S	12	5	52.5	15.5	30	24	27	•		
DG107/16S	16	5	51.5	17.5	30	27	32	•		
DG107/20S	20	15	65.5	28.5	41	36	41	•		
DG107/25S	25	15	66.0	30.0	41	41	46	•		
DG107/30S	30	15	75.5	30.5	60	46	50	•		
DG107/38S	38	15	76.0	31.0	60	55	65	•		

Note: See Table E1 on page E7 for RPM/working pressure data.

Dimensions and pressures for reference only, subject to change.

TABLE OF CONTENTS

VISUAL INDEX

E

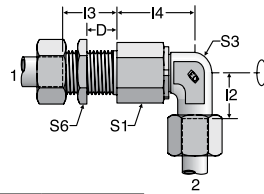


TABLE OF CONTENTS

VISUAL INDEX

DG108

Ball Bearing Rotary Bulkhead Elbow
24° Flareless / 24° Flareless

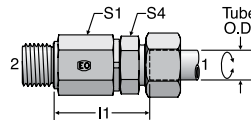


TUBE FITTING PART #	END SIZE		I 2 (mm)	I 3 (mm)	I 4 (mm)	S 1 (mm)	S 3 (mm)	S 6 (mm)	Pressure Rating (bar)	
	1 & 2 (mm)	D (mm)							EO	CF
DG108/06S	6	5	16.0	16.0	39.5	22	17	19		•
DG108/08S	8	5	17.0	16.0	39.5	22	17	22		•
DG108/12S	12	5	21.5	15.5	51.0	30	22	27		•
DG108/16S	16	5	24.5	17.5	49.0	30	22	32		•
DG108/20S	20	15	26.5	28.5	67.0	41	36	41		•
DG108/25S	25	15	30.0	30.0	65.0	41	36	46		•
DG108/30S	30	15	35.5	30.5	82.5	60	50	50		•
DG108/38S	38	15	41.0	31.0	80.5	60	50	65		•

Note: See Table E1 on page E7 for RPM/working pressure data.

DG102-R

Ball Bearing Rotary Straight
24° Flareless / BSPP

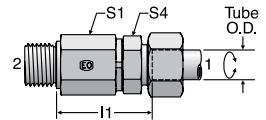


TUBE FITTING PART #	END SIZE		I 1 (mm)	S 1 (mm)	S 4 (mm)	Pressure Rating (bar)	
	1 (mm)	2 BSPP				EO	CF
DG102/06SR	6	G 1/4 A	42.0	22	17		•
DG102/08SR	8	G 1/4 A	42.0	22	17		•
DG102/12SR	12	G 3/8 A	52.5	30	24		•
DG102/16SR	16	G 1/2 A	51.5	30	27		•
DG102/20SR	20	G 3/4 A	65.5	41	36		•
DG102/25SR	25	G 1 A	66.0	41	41		•
DG102/30SR	30	G 1 1/4 A	75.5	60	46		•
DG102/38SR	38	G 1 1/2 A	76.0	60	55		•

Note: See Table E1 on page E7 for RPM/working pressure data.

DG102-M

Ball Bearing Rotary Straight
24° Flareless / Metric Parallel

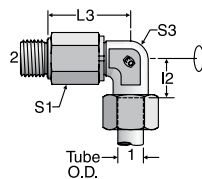


TUBE FITTING PART #	END SIZE		I 1 (mm)	S 1 (mm)	S 4 (mm)	Pressure Rating (bar)	
	1 (mm)	2 Metric				EO	CF
DG102/06SM	6	M14 x 1.5	42.0	22	17		•
DG102/08SM	8	M14 x 1.5	42.0	22	17		•
DG102/12SM	12	M18 x 1.5	52.5	30	24		•
DG102/16SM	16	M22 x 1.5	51.5	30	27		•
DG102/20SM	20	M27 x 2	65.5	41	36		•
DG102/25SM	25	M33 x 2	66.0	41	41		•
DG102/30SM	30	M42 x 2	75.5	60	46		•
DG102/38SM	38	M48 x 2	76.0	60	55		•

Note: See Table E1 on page E7 for RPM/working pressure data.

DG104-R

Ball Bearing Rotary Elbow
24° Flareless / BSPP with EOlastic Seal



TUBE FITTING PART #	END SIZE		i 2 (mm)	L 3 (mm)	S 1 (mm)	S 3 (mm)	Pressure Rating (bar)	
	1 (mm)	2 BSPP					EO	CF
DG104/06SR	6	G 1/4 A	16.0	39.5	22	17		•
DG104/08SR	8	G 1/4 A	17.0	39.5	22	17		•
DG104/12SR	12	G 3/8 A	21.5	51.0	30	22		•
DG104/16SR	16	G 1/2 A	24.5	49.0	30	22		•
DG104/20SR	20	G 3/4 A	26.5	67.0	41	36		•
DG104/25SR	25	G 1 A	30.0	65.0	41	36		•
DG104/30SR	30	G 1 1/4 A	35.5	82.5	60	50		•
DG104/38SR	38	G 1 1/2 A	41.0	80.5	60	50		•

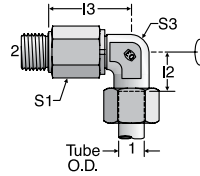
Note: See Table E1 on page E7 for RPM/working pressure data.

Dimensions and pressures for reference only, subject to change.



DG104-M

Ball Bearing Rotary Elbow
24° Flareless / Metric Parallel

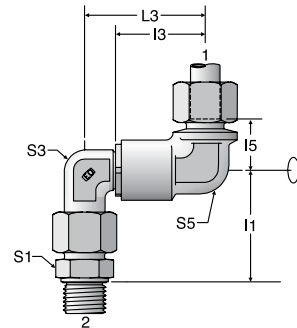


TUBE FITTING PART #	END SIZE		I2 (mm)	I3 (mm)	S1 (mm)	S3 (mm)	Pressure Rating (bar)	
	1 (mm)	2 Metric					EO	CF
DG104/06SM	6	M14 x 1.5	16.0	39.5	22	17		
DG104/08SM	8	M14 x 1.5	17.0	39.5	22	17	•	
DG104/12SM	12	M18 x 1.5	21.5	51.0	30	22	•	
DG104/16SM	16	M22 x 1.5	24.5	49.0	30	22	•	
DG104/20SM	20	M27 x 2	26.5	67.0	41	36		
DG104/25SM	25	M33 x 2	30.0	65.0	41	36	•	
DG104/30SM	30	M42 x 2	35.5	82.5	60	50		
DG104/38SM	38	M48 x 2	41.0	80.5	60	50		

Note: See Table E1 on page E7 for RPM/working pressure data.

DG106-R

Ball Bearing Rotary Double Elbow
24° Flareless / BSPP with EOlastic Seal

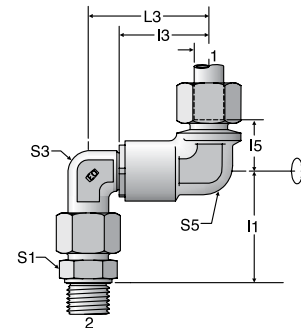


TUBE FITTING PART #	END SIZE		I1 (mm)	I3 (mm)	I5 (mm)	L3 (mm)	S1 (mm)	S3 (mm)	S5 (mm)	Pressure Rating (bar)	
	1 (mm)	2 BSPP								EO	CF
DG106/12SR	12	G 3/8 A	55.5	39.5	26.5	53.0	22	24	22		
DG106/16SR	16	G 1/2 A	61.5	39.5	25.5	53.0	27	24	24	•	
DG106/20SR	20	G 3/4 A	69.5	56.5	39.5	76.0	32	36	32		
DG106/25SR	25	G 1 A	78	56.5	38.0	76.0	41	36	32		
DG106/30SR	30	G 1 1/4 A	86.5	65.0	44.5	92.5	50	50	50		
DG106/38SR	38	G 1 1/2 A	101.0	65.0	42.0	92.5	55	50	50		

Note: See Table E1 on page E7 for RPM/working pressure data.

DG106-M

Ball Bearing Rotary Double Elbow
24° Flareless / Metric Parallel



TUBE FITTING PART #	END SIZE		I1 (mm)	I3 (mm)	I5 (mm)	L3 (mm)	S1 (mm)	S3 (mm)	S5 (mm)	Pressure Rating (bar)	
	1 (mm)	2 Metric								EO	CF
DG106/12SM	12	M18 x 1.5	55.5	39.5	26.5	53	24	24	22		
DG106/16SM	16	M22 x 1.5	61.5	39.5	25.5	53	27	24	24	•	
DG106/20SM	20	M27 x 2	69.5	56.5	39.5	76	32	36	32		
DG106/25SM	25	M33 x 2	78.0	56.5	38.0	76	41	36	32		
DG106/30SM	30	M42 x 2	86.5	65.0	44.5	92.5	50	50	50		
DG106/38SM	38	M48 x 2	101.0	65.0	42.0	92.5	55	50	50		

Note: See Table E1 on page E7 for RPM/working pressure data.

Dimensions and pressures for reference only, subject to change.

TABLE OF CONTENTS
VISUAL INDEX

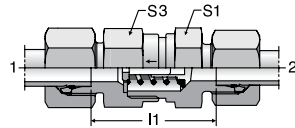
E

TABLE
OF
CONTENTS

VISUAL
INDEX

RHD

Non-Return Valve
24° Flareless / 24° Flareless



TUBE FITTING PART #	END SIZE		DN SIZE (mm)	I 1 (mm)	S1 (mm)	S3 Steel (mm)	S3 (Stainless Steel) (mm)		Pressure Rating (bar)			
	1 & 2 (mm)	S3 (Stainless Steel) (mm)					EO		EO-2			
							CF	71	CF	71		
RHD06L	6	4	29.0	17	17	17	400	250	400	250		
RHD08L	8	6	30.0	19	19	19	400	250	400	250		
RHD10L	10	8	40.5	22	24	24	400	250	400	250		
RHD12L	12	10	43.5	27	30	30	400	250	400	250		
RHD15L	15	12	47.5	27	32	32	400	250	400	250		
RHD18L	18	16	51.5	36	41	36	400	160	400	160		
RHD22L	22	20	61.5	41	46	46	250	160	250	160		
RHD28L	28	25	69.5	50	55	55	250	100	250	100		
RHD35L	35	32	74.5	60	65	60	250	100	250	100		
RHD42L	42	32	74.0	65	70	70	250	100	250	100		
RHD06S	6	3	34.5	19	19	19	420	400	420	400		
RHD08S	8	4	34.5	19	19	19	420	400	420	400		
RHD10S	10	6	40.5	22	24	24	420	400	420	400		
RHD12S	12	8	42.5	24	27	27	420	400	420	400		
RHD14S	14	10	47.5	27	32	32	420	315	420	315		
RHD16S	16	12	50.5	32	36	36	420	315	420	315		
RHD20S	20	16	54.5	41	50	46	420	250	420	250		
RHD25S	25	20	58.5	46	55	50	420	250	420	250		
RHD30S	30	25	69.5	60	60	60	250	250	250	250		
RHD38S	38	32	75.5	65	70	70	250	250	250	250		

Note: These valves are not compatible with steam, oxygen and explosive gases.

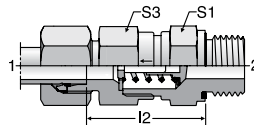
For EO-2 part number, insert "Z" between size and pressure series.

Example: RHD06ZLCF

For Optional Opening Pressures see page E8.

RHV-R-ED

Non-Return Valve
24° Flareless / BSPP
with EOlastic Seal



TUBE FITTING PART #	END SIZE		DN SIZE (mm)	I 2 (mm)	S1 (mm)	S3 (Steel) (mm)	S3 (Stainless Steel) (mm)		Pressure Rating (bar)			
	1 (mm)	2 BSPP					EO		EO-2			
							CF	71	CF	71		
RHV06LRED	6	G 1/8 A	3.5	28.0	17	17	17	400	250	400	250	
RHV08LRED	8	G 1/4 A	5.5	30.0	19	19	19	400	250	400	250	
RHV10LRED	10	G 1/4 A	7.5	38.5	22	24	24	400	250	400	250	
RHV12LRED	12	G 3/8 A	9.5	42.5	27	30	30	400	250	400	250	
RHV15LRED	15	G 1/2 A	11.0 ¹	45.5	27	32	32	400	250	400	250	
RHV18LRED	18	G 1/2 A	14.0	50.0	36	41	36	400	160	400	160	
RHV22LRED	22	G 3/4 A	18.0	55.0	41	46	46	250	160	250	160	
RHV28LRED	28	G 1 A	23.0	63.0	50	55	55	250	100	250	100	
RHV35LRED	35	G 1 1/4 A	29.0	69.0	60	65	60	250	100	250	100	
RHV42LRED	42	G 1 1/2 A	29.0	68.5	65	70	70	250	100	250	100	
RHV06SRED	6	G 1/4 A	3.5	31.5	19	19	19	420	400	420	400	
RHV08SRED	8	G 1/4 A	3.5	31.5	19	19	19	420	400	420	400	
RHV10SRED	10	G 3/8 A	5.5	38.0	22	24	24	420	400	420	400	
RHV12SRED	12	G 3/8 A	7.5	41.0	24	27	27	420	400	420	400	
RHV14SRED	14	G 1/2 A	9.5	44.5	27	32	32	420	315	420	315	
RHV16SRED	16	G 1/2 A	11.0 ¹	48.0	32	36	36	420	315	420	315	
RHV20SRED	20	G 3/4 A	15.0	52.0	41	50	46	420	250	420	250	
RHV25SRED	25	G 1 A	19.0	54.5	46	55	50	420	250	420	250	
RHV30SRED	30	G 1 1/4 A	24.0	64.0	60	60	60	250	250	250	250	
RHV38SRED	38	G 1 1/2 A	29.0	69.5	65	70	70	250	250	250	250	

Note: These valves are not compatible with steam, oxygen and explosive gases.

¹Stainless steel is 11.5

For EO-2 part number, insert "Z" between size and pressure series.

Example: RHV06ZLREDCF

For Optional Opening Pressures see page E8.

Dimensions and pressures for reference only, subject to change.



RHV-M-ED

Non-Return Valve
24° Flareless / Metric Parallel
with EOlastic Seal

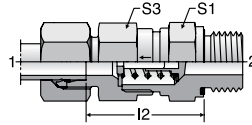


TABLE
OF
CONTENTS

VISUAL
INDEX

E

TUBE FITTING PART #	END SIZE		DN SIZE (mm)	I 2 (mm)	S1 (mm)	S3 (Steel) (mm)	S3 (Stainless Steel) (mm)	Pressure Rating (bar)			
	1 (mm)	2 Metric						EO		EO-2	
								CF	71	CF	71
RHV06LMED	6	M10 x 1	3.5	28.0	17	17	17	400	250	400	250
RHV08LMED	8	M12 x 1.5	5.5	29.0	19	19	19	400	250	400	250
RHV10LMED	10	M14 x 1.5	7.5	38.5	22	24	24	400	250	400	250
RHV12LMED	12	M16 x 1.5	9.5	42.5	27	30	30	400	250	400	250
RHV15LMED	15	M18 x 1.5	11.0 ¹	45.5	27	32	32	400	250	400	250
RHV18LMED	18	M22 x 1.5	14.0	50.0	36	41	36	400	160	400	160
RHV22LMED	22	M26 x 1.5	18.0	55.0	41	46	46	250	160	250	160
RHV28LMED	28	M33 x 2	23.0	63.0	50	55	55	250	100	250	100
RHV35LMED	35	M42 x 2	29.0	69.0	60	65	60	250	100	250	100
RHV42LMED	42	M48 x 2	29.0	68.5	65	70	70	250	100	250	100
RHV06SMED	6	M12 x 1.5	3.5	31.5	19	19	19	420	400	420	400
RHV08SMED	8	M14 x 1.5	5.5	31.5	19	19	19	420	400	420	400
RHV10SMED	10	M16 x 1.5	5.5	38.0	22	24	24	420	400	420	400
RHV12SMED	12	M18 x 1.5	7.5	41.0	24	27	27	420	400	420	400
RHV14SMED	14	M20 x 1.5	9.5	44.5	27	32	32	420	315	420	315
RHV16SMED	16	M22 x 1.5	11.0 ¹	48.0	32	36	36	420	315	420	315
RHV20SMED	20	M27 x 2	15.0	52.0	41	50	46	420	250	420	250
RHV25SMED	25	M33 x 2	19.0	54.5	46	55	50	420	250	420	250
RHV30SMED	30	M42 x 2	24.0	64.0	60	60	60	250	250	250	250
RHV38SMED	38	M48 x 2	29.0	69.5	65	70	70	250	250	250	250

¹Stainless steel is 11.5

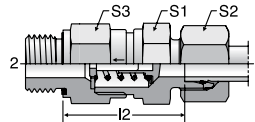
For EO-2 part number, insert "Z" between size and pressure series.
Example: RHV06ZLMEDCF

For Optional Opening Pressures see page E8.

Note: These valves are not compatible with steam, oxygen and explosive gases.

RHZ-R-ED

Non-Return Valve
24° Flareless / BSPP



TUBE FITTING PART #	END SIZE		DN SIZE (mm)	I 2 (mm)	S1 (mm)	S3 (Steel) (mm)	S3 (Stainless Steel) (mm)	Pressure Rating (bar)			
	1 (mm)	2 BSPP						EO		EO-2	
								CF	71	CF	71
RHZ06LRED	6	G 1/8 A	3.5	26.5	17	17	17	400	250	400	250
RHZ08LRED	8	G 1/4 A	5.5	28.5	19	19	19	400	250	400	250
RHZ10LRED	10	G 1/4 A	7.5	38.5	22	24	24	400	250	400	250
RHZ12LRED	12	G 3/8 A	9.5	40.5	27	30	30	400	250	400	250
RHZ15LRED	15	G 1/2 A	11.0 ¹	42.5	27	32	32	400	250	400	250
RHZ18LRED	18	G 1/2 A	14.0	48.0	36	41	36	400	160	400	160
RHZ22LRED	22	G 3/4 A	18.0	56.0	41	46	46	250	160	250	160
RHZ28LRED	28	G 1 A	23.0	64.0	50	55	55	250	100	250	100
RHZ35LRED	35	G 1 1/4 A	29.0	70.0	60	65	60	250	100	250	100
RHZ42LRED	42	G 1 1/2 A	29.0	70.5	65	70	70	250	100	250	100
RHZ06SRED	6	G 1/4 A	3.5	31.5	19	19	19	420	400	420	400
RHZ08SRED	8	G 1/4 A	3.5	31.5	19	19	19	420	400	420	400
RHZ10SRED	10	G 3/8 A	5.5	38.0	22	24	24	420	400	420	400
RHZ12SRED	12	G 3/8 A	7.5	41.0	24	27	27	420	400	420	400
RHZ14SRED	14	G 1/2 A	9.5	43.5	27	32	32	420	315	420	315
RHZ16SRED	16	G 1/2 A	11.0 ¹	46.0	32	36	36	420	315	420	315
RHZ20SRED	20	G 3/4 A	15.0	50.0	41	50	46	420	250	420	250
RHZ25SRED	25	G 1 A	19.0	54.5	46	55	50	420	250	420	250
RHZ30SRED	30	G 1 1/4 A	24.0	64.0	60	60	60	250	250	250	250
RHZ38SRED	38	G 1 1/2 A	29.0	71.5	65	70	70	250	250	250	250

¹Stainless steel is 11.5

For EO-2 part number, insert "Z" between size and pressure series.
Example: RHZ06ZLREDCF

For Optional Opening Pressures see page E8.

Note: These valves are not compatible with steam, oxygen and explosive gases.

Dimensions and pressures for reference only, subject to change.



RHZ-M-ED

Non-Return Valve
24° Flareless / Metric Parallel with
EOlastic Seal

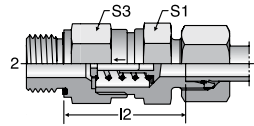


TABLE
OF
CONTENTS

VISUAL
INDEX

TUBE FITTING PART #	END SIZE		DN SIZE (mm)	I 2 (mm)	S1 (mm)	S3 (mm)	Pressure Rating (bar)			
	1 (mm)	2 Metric					EO		EO-2	
							CF	71	CF	71
RHZ06LMED	6	M10 x 1	3.5	26.5	17	17	400	250	400	250
RHZ08LMED	8	M12 x 1.5	5.5	28.5	19	19	400	250	400	250
RHZ10LMED	10	M14 x 1.5	7.5	38.5	22	24	400	250	400	250
RHZ12LMED	12	M16 x 1.5	9.5	40.5	27	30	400	250	400	250
RHZ15LMED	15	M18 x 1.5	11.5	42.5	27	32	400	250	400	250
RHZ18LMED	18	M22 x 1.5	14.0	48.0	36	41	400	160	400	160
RHZ22LMED	22	M26 x 1.5	18.0	56.0	41	46	250	160	250	160
RHZ28LMED	28	M33 x 2	23.0	64.0	50	55	250	100	250	100
RHZ35LMED	35	M42 x 2	29.0	70.0	60	65	250	100	250	100
RHZ42LMED	42	M48 x 2	29.0	70.5	65	70	250	100	250	100
RHZ06SMED	6	M12 x 1.5	3.5	31.5	19	19	420	400	420	400
RHZ08SMED	8	M14 x 1.5	3.5	31.5	19	19	420	400	420	400
RHZ10SMED	10	M16 x 1.5	5.5	38.0	22	24	420	400	420	400
RHZ12SMED	12	M18 x 1.5	7.5	41.0	24	27	420	400	420	400
RHZ14SMED	14	M20 x 1.5	9.5	43.5	27	32	420	315	420	315
RHZ16SMED	16	M22 x 1.5	11.5	46.0	32	36	420	315	420	315
RHZ20SMED	20	M27 x 2	15.0	50.0	41	50	420	250	420	250
RHZ25SMED	25	M33 x 2	19.0	54.5	46	55	420	250	420	250
RHZ30SMED	30	M42 x 2	24.0	64.0	60	60	250	250	250	250
RHZ38SMED	38	M48 x 2	29.0	71.5	65	70	250	250	250	250

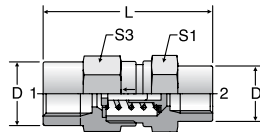
Note: These valves are not compatible with steam, oxygen and explosive gases.

For EO-2 part number, insert "Z" between size and pressure series.
Example: RHZ06ZLMEDCF

For Optional Opening Pressures see page E8.

RHDI

Non-Return Valve
BSPP Female / BSPP Female



TUBE FITTING PART #	END SIZE 1 & 2 BSPP	DN SIZE (mm)	D (mm)	L (mm)	S1 (mm)	S3 (mm)	Pressure Rating (bar)	
							EO	
							CF	71
RHD11/8	G 1/8	3.5	19	42.5	19	19	400	400
RHD11/4	G 1/4	3.5	19	51	19	19	400	400
RHD13/8	G 3/8	7.5	24	60	24	27	400	400
RHD11/2	G 1/2	11.5	32	72	32	36	315	315
RHD13/4	G 3/4	15.0	41	84	41	46	250	250
RHD1	G 1	19.0	46	95	46	50	250	250
RHD111/4	G 1 1/4	24.0	60	110	60	60	250	250
RHD111/2	G 1 1/2	29.0	65	114	65	70	250	250

Note: These valves are not compatible with steam, oxygen and explosive gases.

For Optional Opening Pressures see page E8.

Dimensions and pressures for reference only, subject to change.

RVP

Non-Return Valve
Cartridge

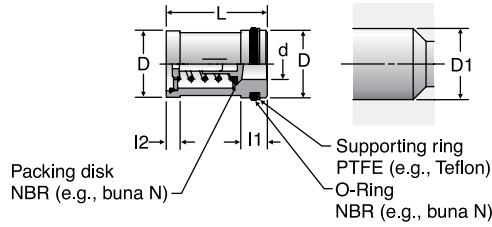


TABLE
OF
CONTENTS

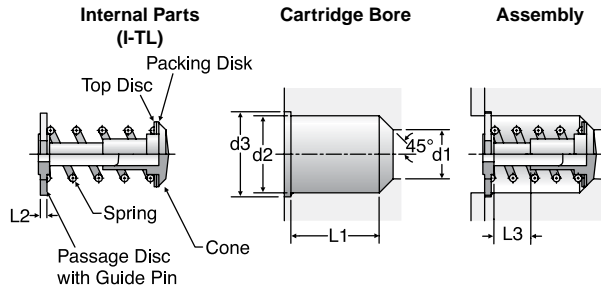
VISUAL
INDEX

E

TUBE FITTING PART #	d (mm)	D (mm)	D1 (mm)	I1 (mm)	I2 (mm)	L (mm)	Pressure Rating (bar)	
							EO	
							CF	71
RVP13	3.5	13	13	9.5	6.0	23.0	420	400
RVP16	5.5	16	16	9.5	6.5	26.5	420	400
RVP20	7.5	20	20	9.5	6.5	30.0	420	400
RVP24	9.5	24	24	12.0	7.5	35.0	420	315
RVP27	11.5	27	27	12.0	7.5	38.0	420	315
RVP35	15.0	35	35	12.0	9.5	44.5	420	250
RVP40	19.0	40	40	12.0	11.0	50.5	420	250
RVP47	24.0	47	47	13.0	13.0	60.0	250	250
RVP55	29.0	55	55	16.0	13.0	70.0	250	250

I-TL

Non-Return Valve
Internal Parts



TUBE FITTING PART #	For Use With	d1 (mm)	d2 (mm)	d3 (mm)	L1 (mm)	L2 (mm)	L3 (mm)	STANDARD FROM STOCK		
								S	SS	B
								ITL06L/06 + 08S	6L, 6S, 8S	3.5
ITL08L/10S	8L, 10S	5.5	10.2	11.6	11.0	2.0	1.7	•		
ITL10L/12S	10L, 12S	7.5	13.0	14.1	14.0	2.0	2.3	•		
ITL12L/14S	12L, 14S	9.5	16.7	18.1	16.5	2.5	2.9	•		
ITL15L/16S	15L, 16S	11.5	19.5	20.6	19.0	2.5	3.5	•		
ITL18L/20S	18L, 20S	15	25.2	27.1	22.5	3.0	4.4			
ITL22L/25S	22L, 25S	19	30.8	32.6	27.0	3.0	5.5	•		
ITL28L/30S	28L, 30S	24	38.6	40.6	32.5	3.5	7.3			
ITL35L + 42L/38S	35L, 42L, 38S	29	45.7	48.1	37.5	3.5	8.9			

Note: Omit "CF" in the part number for steel material.

Standard: Material steel zinc plated (CF), springs phosphated and oiled. Packing disc of NBR (e.g., buna N), opening pressure 1 bar.

On request:

- Packing disc of FKM (e.g., fluorocarbon)
- Stainless steel 1.4571, packing disc of NBR (e.g., buna N) or FKM (e.g., fluorocarbon) (on request).

Temperature rating, without pressure reductions of steel non-return valves with NBR seals (e.g., buna N-standard) is -35°C to +100°C and with FKM seals (e.g., fluorocarbon) (on request) is -25°C to +120°C.

Dimensions and pressures for reference only, subject to change.

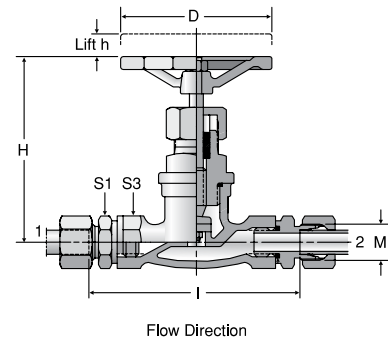


DV

Shut-Off Valve, PN 10
 24° Flareless / 24° Flareless

TUBE FITTING PART #	END SIZE 1 & 2 (mm)	M Metric	DN SIZE (mm)	D (mm)	h Lift (mm)	H (mm)	I (mm)	S1 (mm)	S3 (mm)	Pressure Rating (bar)	
										EO	MS
										DV06L	6
DV08L	8	14 x 1.5	6	50	7	63	88	22	21	10	10
DV10L	10	16 x 1.5	8	50	7	63	90	22	21	10	10
DV12L	12	18 x 1.5	10	50	7	63	90	22	21	10	10
DV15L	15	22 x 1.5	12	50	8	65	93	27	25	10	10
DV18L	18	26 x 1.5	16	50	8	67	94	27	25	10	10
DV22L	22	30 x 2	20	60	8	67	108	32	32	10	10
DV28L	28	36 x 2	25	60	10	95	125	41	38	10	10
DV35L	35	45 x 2	32	70	10	102	145	50	47	10	10

Note: The pressure specification PN for hand operated shut-off valves applies to the design factor 1.5 (according to DIN 3230 T5 and ISO 5208). Omit "MS" in the part number for brass material.

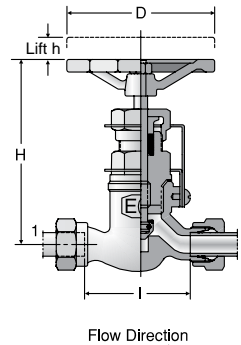


LD

Shut-Off Valve, PN 40
 24° Flareless / 24° Flareless

TUBE FITTING PART #	END SIZE 1 & 2 (mm)	DN SIZE (mm)	D (mm)	h LIFT (mm)	H (mm)	I (mm)	Pressure Rating (bar)	
							EO	MS
							LD10S	10
LD12S	12	8	63	7	98	49	40	40
LD14S	14	10	63	7	98	54	40	40
LD16S	16	12	80	9	110	67	40	40
LD20S	20	16	80	9	110	69	40	40
LD25S	25	20	100	12	129	86	40	40
LD30S	30	25	100	12	129	93	40	40
LD38S	38	32	100	12	158	108	40	40

Note: The pressure specification PN for hand operated shut-off valves applies to the design factor 1.5 (according to DIN 3230 T5 and ISO 5208). Omit "MS" in the part number for brass material.



Dimensions and pressures for reference only, subject to change.

VDHA

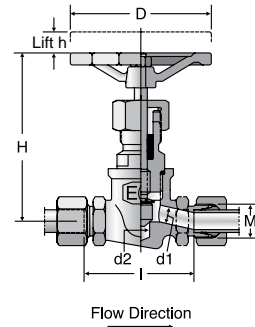
High Pressure Valve
24° Flareless / 24° Flareless

TUBE FITTING PART #	END SIZE (mm)	DN SIZE (mm)	d1 (mm)	d2 (mm)	D (mm)	h Lift (mm)	H (mm)	I (mm)	Pressure Rating (bar)	
									EO CF	EO-2 CF
VDHA06S	6	3	4	9.5	100	6	120	66	630	630
VDHA08S	8	4	5	9.5	100	6	120	66	630	630
VDHA10S	10	6	7	9.5	100	6	120	65	630	630
VDHA12S	12	8	8	9.5	100	6	120	65	630	630
VDHA14S	14	10	10	9.5	100	6	120	84	630	630
VDHA16S	16	12	11	9.5	100	6	120	83	400	400
VDHA20S	20	16	13	11.0	100	6	120	79	400	400
VDHA25S	25	20	17	12.0	125	9	143	106	400	400
VDHA30S	30	25	19	22.5	125	12	164	103	250	250
VDHA38S	38	32	25	26.5	180	12	198	118	250	250

For EO-2 part number, insert "Z" between size and pressure series.

Example: VDHA06ZS

Note: The pressure specification PN for hand operated shut-off valves applies to the design factor 1.5 (according to DIN 3230 T5 and ISO 5208).



Internal threaded spindle and body of low grade forged stainless steel

TABLE OF CONTENTS

VISUAL INDEX

E

VDHB

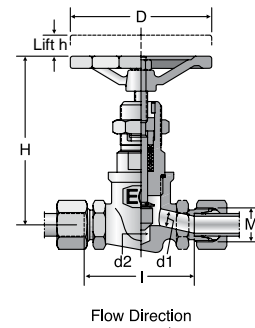
High Pressure Valve – Panel Mount
24° Flareless / 24° Flareless

TUBE FITTING PART #	END SIZE (mm)	DN SIZE (mm)	M Metric	d1 (mm)	d2 (mm)	D (mm)	h Lift (mm)	H (mm)	I (mm)	Pressure Rating (bar)	
										EO 71	EO-2 71
VDHB06S	6	4	14 x 1.5	4	9.5	100	6	124	66	400	400
VDHB08S	8	4	16 x 1.5	5	9.5	100	6	124	66	400	400
VDHB10S	10	6	18 x 1.5	7	9.5	100	6	124	65	400	400
VDHB12S	12	8	20 x 1.5	8	9.5	100	6	124	65	400	400
VDHB14S	14	10	22 x 1.5	10	9.5	100	6	124	84	400	400
VDHB16S	16	12	24 x 1.5	11	9.5	100	6	124	83	400	400
VDHB20S	20	16	30 x 2	13	11.0	100	6	124	79	400	400
VDHB25S	25	20	36 x 2	17	12.0	125	9	153	106	400	400

For EO-2 part number, insert "Z" between size and pressure series.

Example: VDHB06ZS

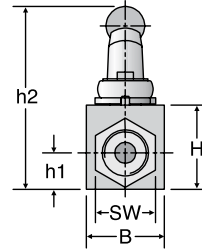
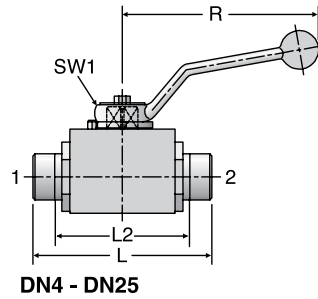
Note: The pressure specification PN for hand operated shut-off valves applies to the design factor 1.5 (according to DIN 3230 T5 and ISO 5208).



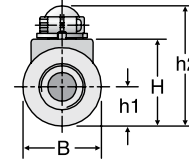
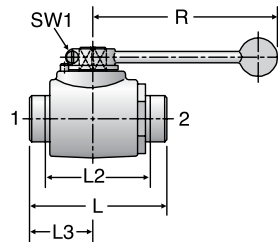
External threaded spindle and body of low grade forged stainless steel

KH

Two-Way Ball Valve
 24° Flareless / 24° Flareless



DN4 - DN25



DN32 - DN40

TABLE OF CONTENTS

VISUAL INDEX

TUBE FITTING PART #	END SIZE (mm)	DN SIZE (mm)	L2 (mm)	L (mm)	h1 (mm)	h2 (mm)	H (mm)	R (mm)	B (mm)	SW (mm)	SW1 (mm)	Pressure Rating (bar)	
												EO	EO2
												CF	CF
KH06L	6	4	53	67	10.0	55.0	25	76	20	19	7	500	500
KH08L	8	6	53	67	10.0	55.0	25	76	20	19	7	500	500
KH10L	10	8	61	75	14.5	68.0	35	100	30	24	8	500	500
KH12L	12	10	61	75	14.5	68.0	35	100	30	24	8	500	500
KH15L	15	12	69	83	17.0	92.0	40	112	35	30	10	500	500
KH18L	18	16	67	82	20.0	105.0	45	166	45	36	11	400	400
KH22L	22	20	84	99	24.0	113.0	55	187	45	41	14	400	400
KH28L	28	25	93	108	26.0	118.0	60	187	55	50	14	400	400
KH35L	35	32	100	121	36.5	180.5	80	320	73	60	17	315	315
KH42L	42	40	96	118	42.5	190.5	90	320	85	70	17	315	315
KH08S	8	4	59	73	10.0	55.0	25	76	20	19	7	500	500
KH10S	10	6	58	73	10.0	55.0	25	76	20	19	7	500	500
KH12S	12	8	62	77	14.5	68.0	35	100	30	24	8	500	500
KH14S	14	10	65	81	14.5	68.0	35	100	30	24	8	500	500
KH16S	16	12	70	87	17.0	92.0	40	112	35	30	10	500	500
KH20S	20	16	69	90	20.0	105.0	45	166	45	36	11	400	400
KH25S	25	20	83	107	24.0	113.0	55	187	45	41	14	400	400
KH30S	30	25	93	120	26.0	118.0	60	187	55	50	14	400	400
KH38S	38	32	95	127	36.5	180.5	80	320	73	60	17	315	315

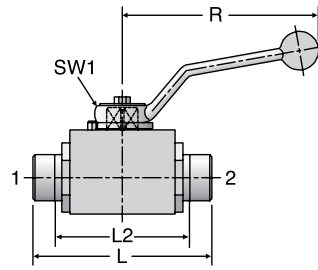
For EO-2 part number, insert "Z" between size and pressure series.
 Example: KH08ZSCF.

Dimensions and pressures for reference only, subject to change.

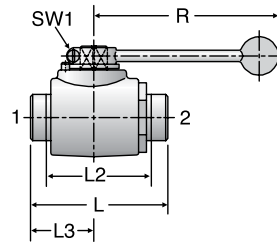
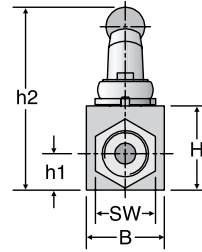


KH

Two-Way Ball Valve
24° Flareless / 24° Flareless
Stainless Steel



DN4 - DN25



DN32 - DN40

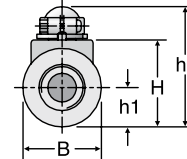


TABLE
OF
CONTENTS

VISUAL
INDEX

E

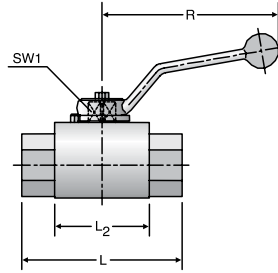
TUBE FITTING PART #	END SIZE (mm)	DN SIZE (mm)	L2 (mm)	L (mm)	h1 (mm)	h2 (mm)	H (mm)	R (mm)	B (mm)	SW (mm)	SW1 (mm)	Pressure Rating (bar)	
												EO	EO2
												71	71
KH06L71X	6	4	59	73	13.7	56.5	30.0	76	30	22	7	500	500
KH08L71X	8	6	59	73	13.7	56.5	30.0	76	30	22	7	500	500
KH10L71X	10	8	73	87	18.0	84.5	40.0	130	40	30	8	500	500
KH12L71X	12	10	73	87	18.0	84.5	40.0	130	40	30	8	500	500
KH15L71X	15	12	77	91	21.0	90.0	45.0	130	45	32	10	500	500
KH18L71X	18	16/12	76	91	21.0	90.0	45.0	130	45	32	10	500	500
KH22L71X	22	20	87	105	31.0	115.0	65.0	185	65	46	14	420	420
KH28L71X	28	25	92	112	38.0	125.0	75.0	185	75	58	14	420	420
KH35L71X	35	32	105	145	45.0	175.0	93.2	320	100	70	19	420	420
KH42L71X	42	40	114	150	52.5	186.0	104.4	320	110	80	19	420	420
KH08S71X	8	4	62	76	13.7	56.5	30.0	76	30	22	7	500	500
KH10S71X	10	6	61	76	13.7	56.5	30.0	76	30	22	7	500	500
KH12S71X	12	8	74	89	18.0	84.5	40.0	130	40	30	8	500	500
KH14S71X	14	10	77	93	18.0	84.5	40.0	130	40	30	8	500	500
KH16S71X	16	12	79	96	21.0	90.0	45.0	130	45	32	10	500	500
KH20S71X	20	16/12	78	99	21.0	90.0	45.0	130	45	32	10	500	500
KH25S71X	25	20	86	113	31.0	115.0	65.0	185	65	46	14	420	420
KH30S71X	30	25	93	124	38.0	125.0	75.0	185	75	50	14	420	420
KH38S71X	38	32	100	145	45.0	175.0	93.2	320	100	70	19	420	420

For EO-2 part number, insert "Z" between size and pressure series.
Example: KH08ZSCF.

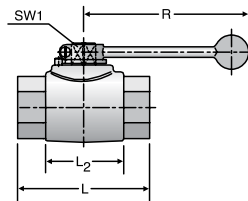
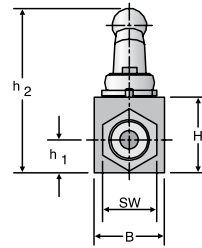
Dimensions and pressures for reference only, subject to change.

KH-R/NPT

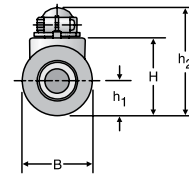
Two-Way Ball Valve
Female BSPP / Female BSPP
Female NPT / Female NPT



DN4-DN25



DN32-DN40



TUBE FITTING PART #	END SIZE		DN SIZE (mm)	B (mm)	h1 (mm)	h2 (mm)	H (mm)	L (mm)	L2 (mm)	R (mm)	SW (mm)	SW1 (mm)	Pressure Rating (bar)	
	1 & 2 NPT / BSPP												EO	CF
	KH1/8X	G 1/8-28											4	20
KH1/4X	G 1/4-19	6	20	10.0	55.0	25.0	69	36	76	19	7	500	500	
KH3/8X	G 3/8-19	10	30	14.5	68.0	35.0	73	45	100	24	8	500	500	
KH1/2X	G 1/2-14	12	35	17.0	92.0	40.0	82	51	112	30	10	500	500	
KH5/8X	G 5/8-14	16	40	20.0	105.0	45.0	88	50	166	36	11	400	400	
KH3/4X	G 3/4-14	20	45	24.0	113.0	55.0	93	60	187	41	14	400	400	
KH1X	G 1-11	25	55	26.0	118.0	60.0	113	70	187	50	14	400	400	
KH11/4X	G 1 1/4-11	32	73	36.5	180.5	80.0	110	70	320	60	17	315	315	
KH11/2X	G 1 1/2-11	40	85	42.5	190.5	90.0	114	75	320	70	17	315	315	
KH1/871X	G 1/8-28	4	30	13.7	56.5	30.0	69	41	76	22	7	500	500	
KH1/471X	G 1/4-19	6	30	13.7	56.5	30.0	75	41	76	22	7	500	500	
KH3/871X	G 3/8-19	10	40	18.0	84.5	40.0	86	53	130	30	8	500	500	
KH1/271X	G 1/2-14	12	45	21.0	90.0	45.0	92	55	130	32	10	500	500	
KH3/471X	G 3/4-14	20	65	31.0	115.0	65.0	111	65	185	46	14	420	420	
KH171X	G 1-11	25	75	38.0	125.0	75.0	122	71	185	50	14	420	420	
KH11/471X	G 1 1/4-11	32	100	45.0	175.0	93.2	110	86	320	70	19	420	420	
KH11/271X	G 1 1/2-11	40	110	52.2	186.0	104.4	120	92	320	80	19	420	420	
KH1/8NPTX	1/8-27	4	20	10.0	55.0	25.0	69	36	76	19	7	500	500	
KH1/4NPTX	1/4-18	6	20	10.0	55.0	25.0	69	36	76	19	7	500	500	
KH3/8NPTX	3/8-18	10	30	14.5	68.0	35.0	73	45	100	24	8	500	500	
KH1/2NPTX	1/2-14	12	35	17.0	92.0	40.0	82	51	112	30	10	500	500	
KH3/4NPTX	3/4-14	20	45	24.0	113.0	55.0	93	60	187	41	14	400	400	
KH1NPTX	1-11 1/2	25	55	26.0	118.0	60.0	113	70	187	50	14	400	400	
KH11/4NPTX	1 1/4-11 1/2	32	73	36.5	108.5	80.0	110	70	320	60	17	315	315	
KH11/2NPTX	1 1/2-11 1/2	40	85	42.5	190.5	90.0	114	75	320	70	17	315	315	
KH1/8NPT71X	1/8-27	4	30	13.7	56.5	30.0	82	41	76	22	7	500	500	
KH1/4NPT71X	1/4-18	6	30	13.7	56.5	30.0	82	41	76	22	7	500	500	
KH3/8NPT71X	3/8-18	10	40	18.0	84.5	40.0	95	53	130	30	8	500	500	
KH1/2NPT71X	1/2-14	12	45	21.0	90.0	45.0	108	55	130	32	10	500	500	
KH3/4NPT71X	3/4-14	20	65	31.0	115.0	65.0	111	65	185	46	14	420	420	
KH1NPT71X	1-11 1/2	25	75	38.0	125.0	75.0	122	71	185	50	14	420	420	
KH11/4NPT71X	1 1/4-11 1/2	32	100	45.0	175.0	93.2	110	86	320	70	19	420	420	
KH11/2NPT71X	1 1/2-11 1/2	40	110	52.2	186.0	104.4	120	92	320	80	19	420	420	

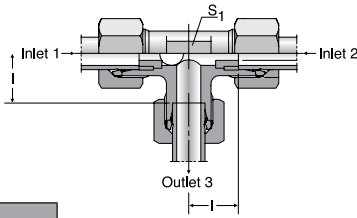
Note: Omit "CF" in the part number for steel material.

Dimensions and pressures for reference only, subject to change.



WV

Alternating Valve
 24° Flareless



TUBE FITTING PART #	END SIZE 1 - 3 (mm)	I (mm)	S1 (mm)	Pressure Rating (bar)
				EO
				CF
WV08L	8	14	14	160
WV10L	10	15	17	160
WV12L	12	17	19	160
WV15L	15	21	19	160

TABLE
 OF
 CONTENTS

VISUAL
 INDEX

E

Dimensions and pressures for reference only, subject to change.

TABLE
OF
CONTENTS

VISUAL
INDEX



Pipe Fittings and Port Adapters

F

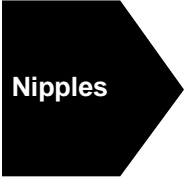

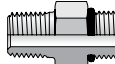

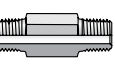


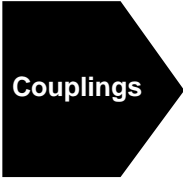
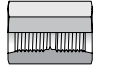
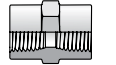
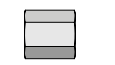

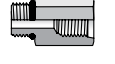
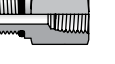
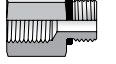

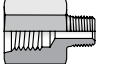
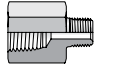
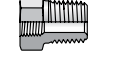
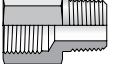
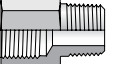
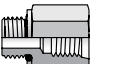
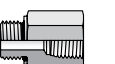
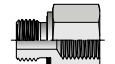

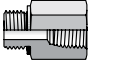

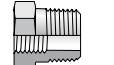
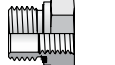
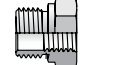

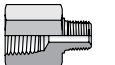
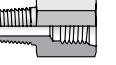

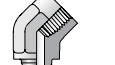

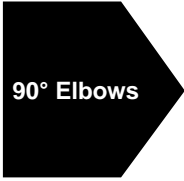
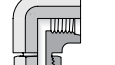
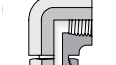

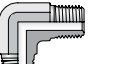
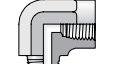
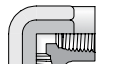
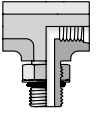
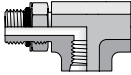
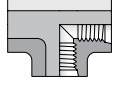
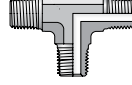
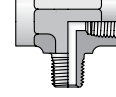
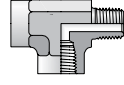

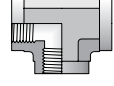
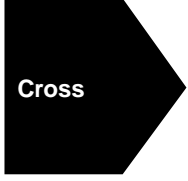
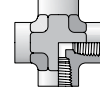














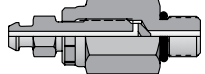
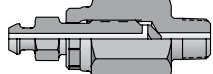
 <p>Nipples</p>	<p>F50HAO SAE-ORB / SAE-ORB</p>  <p>F11</p>	<p>F50F SAE-ORB / NPTF</p>  <p>F11</p>	<p>FF NPTF / NPTF</p>  <p>F11</p>	<p>FFF NPTF / NPTF Long</p>  <p>F11</p>	<p>F80HA80 Metric-ORR / Metric-ORR</p>  <p>F12</p>
	<p>FF33M BSPT / BSPT</p>  <p>F12</p>	 <p>Couplings</p>	<p>G5HG5 SAE-ORB / SAE-ORB</p>  <p>F12</p>	<p>GG NPTF / NPTF</p>  <p>F12</p>	<p>G8HG8 Metric-ORR / Metric-ORR</p>  <p>F13</p>
 <p>Reducers, Expanders, Conversions</p>	<p>F50G5 SAE-ORB / SAE-ORB</p>  <p>F13</p>		<p>F50G SAE-ORB / NPTF</p>  <p>F13</p>	<p>F50HG8 SAE-ORB / Metric</p>  <p>F14</p>	<p>F50HF42 SAE-ORB / BSPP-ED</p>  <p>F14</p>
	<p>FHG5 NPTF / SAE-ORB</p>  <p>F14</p>	<p>FG NPTF / NPTF</p>  <p>F15</p>	<p>PTR Pipe Thread Reducer</p>  <p>F15</p>	<p>FHG8 NPTF / Metric</p>  <p>F15</p>	<p>FHG4 NPTF / BSPP</p>  <p>F15</p>
<p>F80HG5 Metric-ORR / SAE-ORB</p>  <p>F16</p>	<p>F80HG Metric-ORR / NPTF</p>  <p>F16</p>	<p>F82HG8 Metric-ED / Metric-ORR</p>  <p>F17</p>	<p>F40HG5 BSPP-ORR / SAE-ORB</p>  <p>F17</p>	<p>F40HG BSPP-ORR / NPTF</p>  <p>F17</p>	<p>GHG4 BSPP / NPTF</p>  <p>F17</p>
<p>PTR34M BSPT / BSPP</p>  <p>F17</p>	<p>RI-ED BSPP-ED / BSPP</p>  <p>F18</p>	<p>RI BSPP-CF / BSPP</p>  <p>F19</p>	<p>FHF3 BSPT / NPTF</p>  <p>F20</p>	<p>F3HG BSPT / NPTF</p>  <p>F20</p>	<p>F3HG5 BSPT / SAE-ORB</p>  <p>F20</p>
 <p>45° Elbows</p>	<p>CD45 NPTF / NPTF</p>  <p>F20</p>	<p>DD45 NPTF / NPTF</p>  <p>F21</p>	 <p>90° Elbows</p>	<p>AOEG5 SAE-ORB / SAE-ORB</p>  <p>F21</p>	<p>AOEG SAE-ORB / NPTF</p>  <p>F21</p>
	<p>AOE4G SAE-ORB / NPTF Long</p>  <p>F21</p>	<p>CR NPTF / NPTF</p>  <p>F22</p>		<p>CD NPTF / NPTF</p>  <p>F22</p>	<p>DD NPTF / NPTF</p>  <p>F22</p>

TABLE
 OF
 CONTENTS


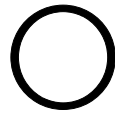
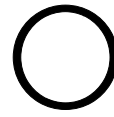
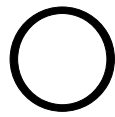
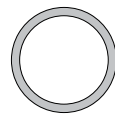
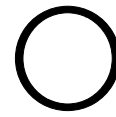
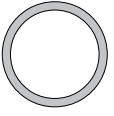

G5G5JAO SAE-ORB Branch Tee  F23	AOG5JG5 SAE-ORB Run Tee  F24	G5G5JG5 SAE-ORB Tee  F24	RRS NPTF Tee  F24	MMS NPTF Branch Tee  F24	MRO NPTF Run Tee  F24
MMO NPTF Tee  F25	MMO444M BSPP Tee  F25	 Cross	KMMOO NPTF Cross  F25	 Plugs, Bleed Adapters	P5ON SAE-ORB Hex Head  F25
HP5ON SAE-ORB Hollow Hex  F26	HP NPTF Hex Head  F26	SHP NPTF Square Head  F26	HHP NPTF Hollow Hex Head  F26	HPC NPTF Pipe Cap  F27	P87OMN ISO 6149 Hex Head  F27
VSTI M-OR ISO 6149 Hollow Hex  F27	VSTI M-ED Metric-ED Hollow Hex  F27	VSTI R-ED BSPP-ED Hollow Hex  F28	P47OMN BSPP-ORB Hex Head  F28	HP3M BSPT Hex Head  F28	

F

Diagnostic, Orifice and Bleed Adapters (Shown in Section M)

 Bleed Adapters	P5ONBA Bleed Screw / Bleed Adapter  M10	HPBA Bleed Screw / NPT  M10
--	---	--

O-Rings and Seals (Shown in Section N)

 O-Rings and Seals	SAE O-Ring  N4	ISO 6149 O-Ring  N5	Metric O-Ring  N5	Metric Retaining Ring  N5	BSPP O-Ring  N6
BSPP Retaining Ring  N6	Elastic Seal Ring  N6				

Pipe Fittings and Port Adapters

This Section contains adapters with thread types including: NPT, NPTF, BSPT, BSPP, SAE UN/UNF, and Metric. All the threads in this section are made to industry specifications with conformance shown in Table F1.

Design and Construction

Shaped products (elbows, tees and crosses) are hot forged and machined, while straights are manufactured from cold drawn barstock. Where applicable, these products are made in conformance with the design criteria of the Society of Automotive Engineers Standards, SAE J514, J530.

Parker Fluid Connector products made from steel and brass, for the most part, have NPTF threads. Stainless steel products may have NPT or slightly modified NPT threads to minimize the chance of galling on assembly.

Standard Material Specifications: The standard materials used in the manufacture of Industrial Pipe and Adapter fittings are shown in Table U1 on page U2.

Note: Upon request, pipe fittings, adapters and plugs could be furnished in materials other than those shown in the material specifications chart.

Finish - Zinc plating with silver chromate (zinc chromium 6 free) is used on all standard steel products. Stainless steel fittings are passivated.

How Port Connections Work

Tapered ("Pipe") Threads

There are three types of tapered threads commonly used in industrial applications.

- NPT/NPTF
- BSPT
- Metric Taper

All three thread styles noted above use the same basic metal-to-metal sealing design for achieving a seal. Although very similar, there are differences in the thread dimensions, pitch, and flank angle that do not allow interchangeability.

NPT / NPTF Threads

NPT threads, when assembled without a sealant, leave a spiral leak path at the crest-root junction as shown in Fig. F1. To seal pressurized fluid, NPT threads require a suitable sealant. NPTF threads (Dryseal), on the other hand, when assembled, do not leave the spiral leak path. This is because they have controlled truncation at the crest and root, ensuring metal-to-metal crest-root contact prior to, or just as the male-female thread flanks make contact as seen in Fig. F2. Upon further tightening, the thread crests are flattened out until the flanks also make metal-to-metal contact as seen in Fig. F3. Thus, theoretically at least, there is no passage left for the fluid to leak, provided all surfaces are flawless and dimensions exact. **In reality, this is not the case and a sealant/lubricant is necessary to achieve a leak free joint, even with NPTF threads.** The sealant/lubricant fills all imperfections in the surfaces affecting the seal and also provides lubrication to ease assembly and minimize galling.

Dimensions and pressures for reference only, subject to change.

Assembly and Installation

Please refer to Section S for the assembly and installation instructions for Pipe Fittings and Port Adapters.

TABLE OF CONTENTS

VISUAL INDEX

Thread	Standard
NPT	ANSI B1.20.1, FED-STD-H28/7
NPTF	SAE J476, ANSI B1.20.3, FED-STD-H28/8
BSPT	BS 21, ISO 7/1
BSPP	BS 2779, ISO 228/1
Metric	ISO 261, ANSI B1.13M, FED-STD-H28/21
UN/UNF*	ANSI B1.1, FED-STD-H28/2

*Class 2A or 2B

Table F1 — Thread Conformance Standards

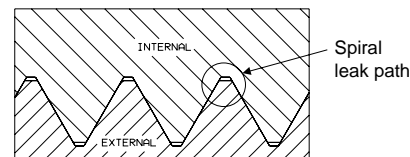


Fig. F1 — NPT: Wrench Tight, No Crest-Root Contact, Flank Contact Only

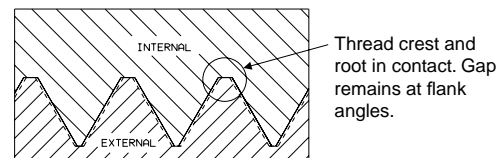


Fig. F2 — NPTF: Hand Tight, Crest to Root Contact

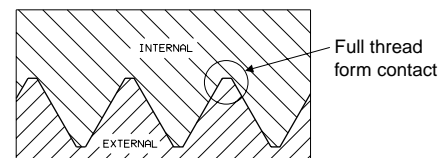


Fig. F3 — NPTF: Wrench Tight, Crest to Root and Flank Contact

Application Guidelines for Tapered Threads

Straight Connectors with NPT/NPTF 3/4-14 and Smaller

Straight connectors with 3/4-14 NPT/NPTF and smaller male pipe threads have very high pressure holding capability and seal reliability when used in applications without “make and break” (such as maintenance) requirements.

They are also well suited for low cycle non-pulsating (static) applications with pressures in excess of 6,000 psi.

Straight Connectors with NPT/NPTF above 3/4 -14 and All Shaped Connectors with NPT/NPTF Threads

It is difficult to always tighten shapes with pipe threads to an optimum tightness level because of orientation requirements. Also, all connectors in this category with pipe threads have low reliability for leak free operation in dynamic applications. Therefore, they are not preferred where a leak free joint is required.

All NPTF Connectors

While a pipe thread connection can be disassembled and re-assembled in low-pressure systems, it is not intended to be a frequently assembled and disassembled connection. (When connectors are known to be disassembled and re-assembled repeatedly, pipe connections are not preferred for high-pressure systems.)

For the above applications, a port connection with an elastomeric seal, such as SAE straight thread port (SAE J1926/ISO11926), SAE four bolt split flange (SAE J518/ISO 6162), and ISO 6149 is recommended. For applications where elastomeric seals can't be used, consult the manufacturer.

As noted, BSPT and metric taper are designed and perform similarly. Follow the NPT/NPTF guidelines for their application.

In general, tapered thread connections have the following limitations which should be considered when specifying port connections:

- Poor dynamic sealing characteristics
- Possible expansion, and even cracking, of the port
- Orientation is a concern in shaped connectors
- Larger threads are more prone to leakage because of more potential leak points
- System contamination due to thread sealant
- Prone to galling, especially in stainless steel
- Limited remakeability

Parallel Thread Adapters

Straight, or parallel, thread ports in various forms are becoming more popular in hydraulic systems because they are more reliable and easier to service.

Three types of threads are used for parallel thread ports:

- UN/UNF (SAE straight thread)
- BSPP (British Standard Pipe, Parallel)
- Metric parallel

Because parallel threads only serve one function (i.e. holding the fitting in place), some other means of sealing is always present, such as an elastomeric O-ring or a metal seal. There are many variations of sealing methods, and in some cases, they are interchangeable among the different thread forms and may appear to be similar.

UN / UNF Threads

SAE J1926 uses UN/UNF threads and is often referred to as SAE Straight Thread. The female port is often referred to as ORB or O-ring boss. This port style, shown in Fig. F4, is widely used in North America.

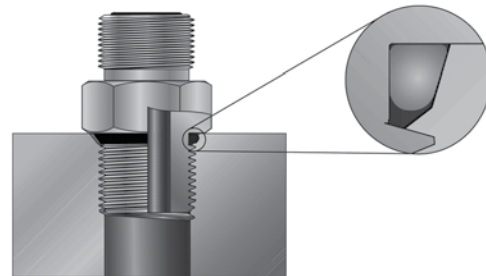


Fig. F4 — Typical O-Ring Boss Port

BSPP

In Europe, Japan and many other former Commonwealth nations, the British Standard Pipe thread form, BSP, is still used extensively to connect pipes and components in hydraulic systems. The BSP thread is offered in a straight (parallel) form known as BSPP and a tapered form known as BSPT. These threads feature a 55° flank angle. Fittings in this section with male BSPP threads use a primary sealing method of an O-ring and retaining ring, as shown in Fig. F5.

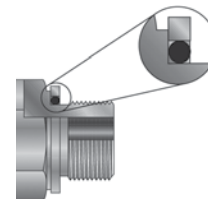


Fig. F5 — O-Ring with Retaining Ring

Additional sealing methods such as a cutting face or an EOlastic seal, as shown in Fig. G6, are also available on other fittings within the catalog. These BSPP fittings are all designed to thread into a female BSPP port (ISO 1179), however, the seal is created with one of the aforementioned sealing methods, not with the threads. It is also important to note that with these BSPP threaded connections, the seal occurs on the port surface, or spotface, not in an O-ring gland or chamfer as SAE and ISO-6149 straight thread do. A detail of the BSPP port is shown on page T35.

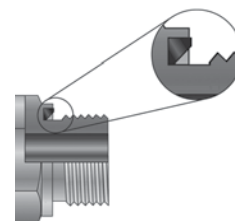


Fig. F6 — O-Ring in Fitting Groove

Dimensions and pressures for reference only, subject to change.

Metric Parallel

In Europe, primarily in Germany, the traditional metric parallel thread form is used extensively to connect components in hydraulic systems. This metric thread is designed to thread into and seal in a female Metric parallel port conforming to ISO-9974-1 (DIN-3852, Part 1). Fittings in this section with male metric threads use a primary sealing method of an O-ring and retaining ring (similar to Fig. F5). Additional sealing methods such as a cutting face or an EOlastic seal (similar to Fig. F6) are also available on other fittings within the catalog. Sealing is accommodated with one of the aforementioned sealing methods, not with the threads. It is also important to note that with these male metric threads, the seal occurs on the top face (spotface) of the port, not in an O-ring gland or chamfer as in SAE and ISO-6149 straight threads. A detail of this metric port is shown on page T32.

To minimize further proliferation of additional port thread styles, the International Standards Organization Technical Committee 131 completed the development of a world standard leak-free port connection. It is recommended that this port, ISO 6149-1, be specified in all new hydraulic fluid power applications.

Parker and other fluid connector manufacturers have expanded product offering to incorporate the ISO 6149 male studs as a standard on many tube fitting products. Parker offers the ISO 6149 male stud end, shown in Fig. F7, on several tube fitting products including: Seal-Lok, Triple-Lok, EO, EO-2, Conversion Adapters, Plugs, etc. This port, utilizes metric parallel threads for mechanical holding power and a sealing method similar to the proven SAE Straight Thread O-ring port. A detail of this metric port is shown on page T32.

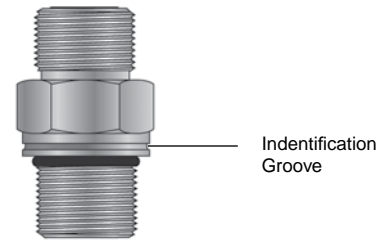


Fig. F7 — ISO 6149 Male

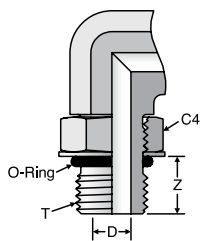
Feature	Advantage	Benefit
Tapered Thread Fittings		
Compact size	Suitable selection for plumbing in limited or tight space in a compact system.	Compact systems are more efficient and reduce the need for excessive routing of costly hose or tube
Widespread acceptability	Available worldwide for OEM and MRO applications	Eases efforts to find component parts and replacement fittings, reducing unnecessary downtime
High static pressure rating	Allows for use in high pressure applications	Increases versatility of fitting
Offered in three standard materials (Steel, Stainless Steel, and Brass)	Allows customer to match media and temperature applications without special fittings and seals.	Reduces component procurement costs and increases fitting availability
Adaptable to ORFS, Flareless Bite-type, Metric Bite-type, 37° flare, etc.	Versatility for end customer and for customer standardization efforts	Standardization reduces procurement costs
High temperature applications	Is not limited by temperature range of elastomeric seal	Increases versatility of fitting
Straight Thread Fittings		
Reliable sealing in dynamics applications	Ideal in systems with high pressure and cycling	Provides reliable, long-term sealing
Unlimited reusability/ remakeability	Extends the service life of the fitting	Reduces maintenance costs and component replacement costs
No thread sealant needed	Eliminates the potential for contaminating and damaging sensitive hydraulic components due to thread sealant	Reduces maintenance costs and component replacement costs
Infinite positioning of shaped adapters	Eliminates potential of damaging adapter and/or component by incorrectly assembling to accomplish correct orientation	Improves assembly time and reduces maintenance costs
Elastomeric seal	Tolerant of minor surface imperfections to provide leak-free connection	Reduces operational and maintenance costs

Dimensions and pressures for reference only, subject to change.

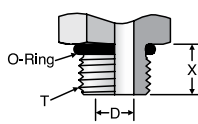
Port Ends for SAE J1926-1 (ISO 11926-1) Port

TABLE
OF
CONTENTS

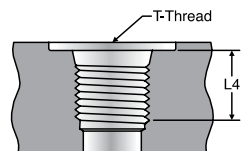
VISUAL
INDEX



**SAE J1926
Adjustable**



**SAE J1926
Nonadjustable**



**SAE J1926-1
Port²⁾**

F

	Thread	Locknut Hex	Drill	Minimum Thread	Stud Length	
SIZE	T UN/UNF	C4 (inch)	D Ref. (inch)	L4 Min (inch)	X (inch)	Z Max (inch)
LIGHT DUTY (TRIPLE-LOK, FERULOK, ADAPTERS)						
2	5/16-24	7/16	0.063	0.390	0.297	0.36
3	3/8-24	1/2	0.126	0.390	0.297	0.33
4	7/16-20	9/16	0.177	0.454	0.360	0.39
5	1/2-20	5/8	0.236	0.454	0.360	0.43
6	9/16-18	11/16	0.295	0.500	0.391	0.43
8	3/4-16	7/8	0.394	0.562	0.438	0.49
10	7/8-14	1	0.492	0.656	0.500	0.56
12	1 1/16-12	1 1/4	0.610	0.750	0.594	0.65
14	1 3/16-12	1 3/8	0.709	0.750	0.594	0.65
16	1 5/16-12	1 1/2	0.846	0.750	0.594	0.65
20	1 5/8-12	1 7/8	1.083	0.750	0.594	0.65
24	1 7/8-12	2 1/8	1.319	0.750	0.594	0.65
32	2 1/2-12	2 3/4	1.772	0.750	0.594	0.59
HEAVY DUTY (SEAL-LOK)						
2	5/16-24	1/2	0.063	0.390	0.374	0.38
3	3/8-24	9/16	0.118	0.390	0.374	0.39
4	7/16-20	5/8	0.177	0.454	0.433	0.43
5	1/2-20	11/16	0.236	0.454	0.433	0.44
6	9/16-18	3/4	0.295	0.500	0.472	0.47
8	3/4-16	15/16	0.378	0.562	0.551	0.54
10	7/8-14	1 1/16	0.492	0.656	0.630	0.63
12	1 1/16-12	1 3/8	0.610	0.750	0.728	0.73
14	1 3/16-12	1 1/2	0.709	0.750	0.728	0.73
16	1 5/16-12	1 5/8	0.846	0.750	0.728	0.73
20	1 5/8-12	1 7/8	1.083	0.750	0.728	0.73
24	1 7/8-12	2 1/8	1.319	0.750	0.728	0.73
32	2 1/2-12	2 3/4	1.575	0.750	0.728	0.73

1) See page N3 for SAE O-rings.

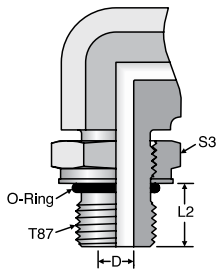
2) See page T33 for port details.

Dimensions and pressures for reference only, subject to change.

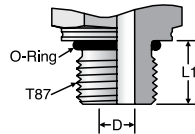
Port Ends for ISO 6149-1 Port

TABLE
 OF
 CONTENTS

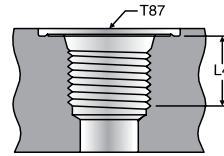
VISUAL
 INDEX



**ISO 6149
 Adjustable**



**ISO 6149
 Nonadjustable**



**ISO 6149
 Port²⁾**

	Thread	Drill	Minimum Thread	Stud Length		Lockhead Hex
SIZE	T87 Metric	D Ref. (mm)	L4 Min (mm)	L1 (mm)	L2 Max (mm)	S3 (mm)
LIGHT DUTY (TRIPLE-LOK, FERULOK, ADAPTERS)						
M8	M8X1	3	10.0	8.5	8.7	12
M10	M10X1	4.5	10.0	8.5	8.7	14
M12	M12X1.5	6	11.5	11.0	11.1	17
M14	M14X1.5	7.5	11.5	11.0	11.1	19
M16	M16X1.5	9	13.0	11.5	11.6	22
M18	M18X1.5	11	14.5	12.5	12.6	24
M20	M20X1.5	—	14.5			—
M22	M22X1.5	14	15.5	13.0	13.0	27
M27	M27X2	18	19.0	16.0	16.0	32
M30	M30X2	—	19.0			—
M33	M33X2	23	19.0	16.0	16.0	41
M38	M38X2	—	19.0			—
M42	M42X2	30	19.5	16.0	16.0	50
M48	M48X2	36	22.0	17.5	17.3	55
M60	M60X2	44	24.5	17.5	17.3	65
HEAVY DUTY (SEAL-LOK)						
M8	M8X1	2	10.0	9.5	9.7	12
M10	M10X1	3	10.0	9.5	9.7	14
M12	M12X1.5	4	11.5	11.0	11.1	17
M14	M14X1.5	6	11.5	11.0	11.1	19
M16	M16X1.5	7	13.0	12.5	12.6	22
M18	M18X1.5	9	14.5	14.0	14.1	24
M20	M20X1.5	11	14.5	14.0		—
M22	M22X1.5	12	15.5	15.0	15.0	27
M27	M27X2	15	19.0	18.5	18.0	32
M30	M30X2	18	19.0	18.5	18.5	36
M33	M33X2	20	19.0	18.5	18.5	41
M38	M38X2	26	19.0	18.5	19.0	46
M42	M42X2	26	19.5	19.0	19.0	50
M48	M48X2	32	22.0	21.5	21.5	55
M60	M60X2	40	24.5	24.0	24.0	65

1) See page N5 for ISO 6149 O-rings.

2) See page T32 for port details.

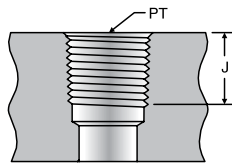
Dimensions and pressures for reference only, subject to change.

NPTF and BSPT Port Ends

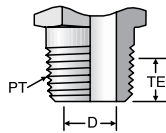
TABLE
 OF
 CONTENTS

VISUAL
 INDEX

F



**NPTF and BSPT
 Port**



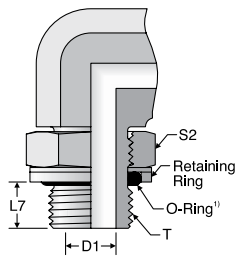
**NPTF and BSPT
 Stud**

	Thread	Drill	Minimum Thread	Thread Engagement
SIZE	PT	D Ref. (inch)	J (inch)	TE (inch)
NPTF				
2	1/8-27	0.188	0.31	0.24
4	1/4-18	0.281	0.44	0.34
6	3/8-18	0.406	0.47	0.34
8	1/2-14	0.531	0.59	0.46
12	3/4-14	0.719	0.63	0.46
16	1-11 1/2	0.938	0.75	0.59
20	1 1/4-11 1/2	1.250	0.78	0.59
24	1 1/2-11 1/2	1.500	0.81	0.59
32	2-11 1/2	1.938	0.81	0.59
BSPT				
2	1/8-28	0.188	0.31	0.24
4	1/4-19	0.281	0.44	0.34
6	3/8-19	0.406	0.47	0.34
8	1/2-14	0.531	0.59	0.46
12	3/4-14	0.719	0.63	0.46
16	1-11	0.938	0.75	0.59
20	1 1/4-11	1.250	0.78	0.59
24	1 1/2-11	1.438	0.81	0.59
32	2-11	1.938	0.81	0.59

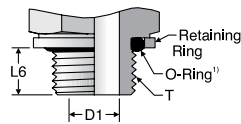
Dimensions and pressures for reference only, subject to change.

Port Ends for ISO 9974-1 and 1179-1 Ports

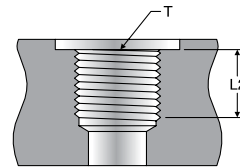
TABLE OF CONTENTS
VISUAL INDEX



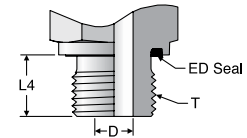
ISO 9974 and 1179 Adjustable O-Ring with Retaining Ring²⁾



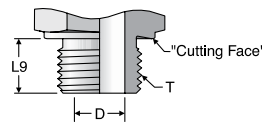
ISO 9974 and 1179 Non-Adjustable O-Ring with Retaining Ring²⁾



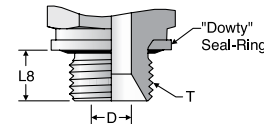
ISO 9974³⁾ and 1179⁴⁾ Port



ISO 9974 and 1179 ED Seal



ISO 9974 and 1179 Cutting Face Seal



Dowty Seal Stud End for ISO 9974-1 and ISO 1179-1 Ports

ISO 9974

SIZE	Thread	Drill Ref.			Port Min Depth	ED Stud	O-Ring, RR Non-Adj Stud	O-Ring, RR Adj-Stud	O-Ring, RR Adj-Stud, Locknut Hex	Dowty Seal Stud	Cutting Face Stud
		O-Ring, RR Stud	Light Duty (L Series)	Heavy Duty (S Series)							
	T Metric	D1 (mm)	D (mm)		L2 (mm)	L4 (mm)	L6 (mm)	L7 (mm)	S2 (mm)	L8 (mm)	L9 (mm)
M8	M8X1	2	—	—	8	—	8.0	8.6	11	—	8
M10	M10X1	4	4	—	8	8	8.0	8.7	14	—	8
M12	M12X1.5	5	6	4	12	12	8.7	10.0	17	—	12
M14	M14X1.5	7	7	5	12	12	8.7	10.0	19	—	12
M16	M16X1.5	9	9	7	12	12	9.0	11.3	21	—	12
M18	M18X1.5	11	11	8	12	12	11.0	12.2	22	—	12
M20	M20X1.5	11	-	10	14	14	12.7	—	—	—	14
M22	M22X1.5	13	14	12	14	14	12.7	13.7	27	—	14
M26	M26X1.5	13	18	—	16	16	14.0	—	—	—	16
M27	M27X2	16	—	16	16	16	15.0	16.8	32	—	16
M33	M33X2	22	23	20	18	18	15.0	16.8	38	—	18
M42	M42X2	28	30	25	20	20	15.5	17.3	48	—	20
M48	M48X2	36	36	32	22	22	19.5	19.3	55	—	22
M60	M60X2	44	—	—	24.5	—	20.5	22.3	65	—	—

ISO 1179

SIZE	Thread	Drill Ref.			Port Min Depth	ED Stud	O-Ring, RR Non-Adj Stud	O-Ring, RR Adj-Stud	O-Ring, RR Adj-Stud, Locknut Hex	Dowty Seal Stud	Cutting Face Stud
		O-Ring, RR Stud	Light Duty (L Series)	Heavy Duty (S Series)							
	T BSPP	D1 (mm)	D (mm)		L2 (mm)	L4 (mm)	L6 (mm)	L7 (mm)	S2 (mm)	L8 (mm)	L9 (mm)
2	1/8-28	4.4	4	—	8	8	6.3	7.2	14	8	8
4	1/4-19	7.5	7	5	12	12	9.4	9.4	19	11	12
6	3/8-19	9.9	9	8	12	12	9.4	9.3	22	12	12
8	1/2-14	12.3	14	12	14	14	12.6	13.1	30	14	14
12	3/4-14	15.5	18	16	16	16	12.6	13.1	36	16	16
16	1-11	21.5	23	20	18	18	16.0	14.7	46	16	18
20	1-1/4-11	27.5	30	25	20	20	16.0	14.7	50	19	20
24	1-1/2-11	33.0	36	32	22	22	16.0	14.7	55	22	22
32	2-11	—	—	—	26	—	16.0	14.7	75	25	—

- 1) See Section N for O-rings and seals.
- 2) O-ring with retaining ring stud ends are not shown in ISO 9974.
- 3) See page T36 for ISO 9974-1 port details.
- 4) See page T35 for ISO 1179-1 port details.

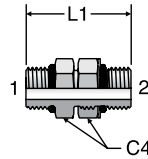
Dimensions and pressures for reference only, subject to change.



F5OHAO

Straight Thread Union
SAE-ORB / SAE-ORB

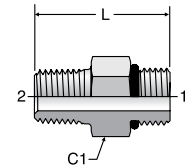
HPD Base # 0505



TUBE FITTING PART #	END SIZE		C4 HEX (in.)	L1 (in.)	Dynamic Pressure (x 1,000 PSI)		
	1	2			-S	-SS	-B
	UN/UNF-2A	UN/UNF-2A					
4 F5OHAO	7/16 - 20	7/16 - 20	9/16	1.27	6.0	6.0	3.3
6 F5OHAO	9/16 - 18	9/16 - 18	11/16	1.41	6.0	6.0	3.3
8 F5OHAO	3/4 - 16	3/4 - 16	7/8	1.64	6.0	6.0	3.3
10 F5OHAO	7/8 - 14	7/8 - 14	1	1.81	5.0	5.0	3.3
12 F5OHAO	1 1/16 - 12	1 1/16 - 12	1 1/4	2.13	5.0	5.0	3.3
16 F5OHAO	1 5/16 - 12	1 5/16 - 12	1 1/2	2.44	4.0	4.0	2.6
20 F5OHAO	1 5/8 - 12	1 5/8 - 12	1 7/8	2.44	4.0	4.0	2.6
24 F5OHAO	1 7/8 - 12	1 7/8 - 12	2 1/8	2.44	3.0	3.0	1.9
32 F5OHAO	2 1/2 - 12	2 1/2 - 12	2 3/4	2.44	2.0	2.0	1.3

F5OF

Male Pipe Adapter
SAE-ORB / NPTF



TUBE FITTING PART #	END SIZE		C1 HEX (in.)	L (in.)	Dynamic Pressure (x 1,000 PSI)		
	1	2			-S	-SS	-B
	UN/UNF-2A	NPTF					
4-1/8 F5OF	7/16 - 20	1/8 - 27	9/16	1.00	6.0	6.0	3.3
4-1/4 F5OF	7/16 - 20	1/4 - 18	9/16	1.20	6.0	6.0	3.3
5-1/4 F5OF	1/2 - 20	1/4 - 18	5/8	1.20	6.0	6.0	3.3
6-1/4 F5OF	9/16 - 18	1/4 - 18	11/16	1.25	6.0	6.0	3.3
6-3/8 F5OF	9/16 - 18	3/8 - 18	11/16	1.34	6.0	6.0	3.3
8-1/4 F5OF	3/4 - 16	1/4 - 18	7/8	1.36	6.0	6.0	3.3
8-3/8 F5OF	3/4 - 16	3/8 - 18	7/8	1.36	6.0	6.0	3.3
8-1/2 F5OF	3/4 - 16	1/2 - 14	7/8	1.53	6.0	6.0	3.3
10-1/2 F5OF	7/8 - 14	1/2 - 14	1	1.59	6.0	6.0	3.3
12-1/2 F5OF	1 1/16 - 12	1/2 - 14	1 1/4	1.80	5.0	6.0	3.3
12-3/4 F5OF	1 1/16 - 12	3/4 - 14	1 1/4	1.80	5.0	6.0	3.3
16-3/4 F5OF	1 5/16 - 12	3/4 - 14	1 1/2	1.78	4.5	5.4	2.9
16-1 F5OF	1 5/16 - 12	1 - 11 1/2	1 1/2	1.98	4.5	5.4	2.9
20-1 1/4 F5OF	1 5/8 - 12	1 1/4 - 11 1/2	1 7/8	2.02	3.0	3.6	1.9
24-1 1/2 F5OF	1 7/8 - 12	1 1/2 - 11 1/2	2 1/8	2.25	3.0	3.0	1.9

TABLE OF CONTENTS

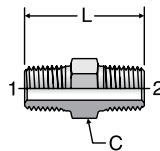
VISUAL INDEX

F

FF

Pipe Nipple
NPTF / NPTF

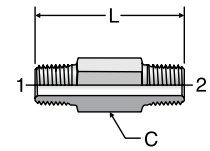
HPD Base # 0101 SAE 140137



TUBE FITTING PART #	END SIZE		C HEX (in.)	L (in.)	Dynamic Pressure (x 1,000 PSI)		
	1	2			-S	-SS	-B
	NPTF	NPTF					
1/8 FF	1/8 - 27	1/8 - 27	7/16	1.06	6.0	7.2	3.9
1/4 x 1/8 FF	1/4 - 18	1/8 - 27	5/8	1.25	6.0	7.2	3.9
1/4 FF	1/4 - 18	1/4 - 18	5/8	1.45	6.0	7.2	3.9
3/8 x 1/8 FF	3/8 - 18	1/8 - 27	3/4	1.27	6.0	7.2	3.9
3/8 x 1/4 FF	3/8 - 18	1/4 - 18	3/4	1.45	6.0	7.2	3.9
3/8 FF	3/8 - 18	3/8 - 18	3/4	1.45	6.0	7.2	3.9
1/2 x 1/8 FF	1/2 - 14	1/8 - 27	7/8	1.52	6.0	7.2	3.3
1/2 x 3/8 FF	1/2 - 14	3/8 - 18	7/8	1.70	6.0	7.2	3.9
1/2 x 1/4 FF	1/2 - 14	1/4 - 18	7/8	1.70	6.0	7.2	3.9
1/2 FF	1/2 - 14	1/2 - 14	7/8	1.89	6.0	7.2	3.9
3/4 x 1/4 FF	3/4 - 14	1/4 - 18	1 1/8	1.78	5.5	6.6	3.5
3/4 x 3/8 FF	3/4 - 14	3/8 - 18	1 1/8	1.78	5.5	6.6	3.5
3/4 x 1/2 FF	3/4 - 14	1/2 - 14	1 1/8	1.96	5.5	6.6	3.5
3/4 FF	3/4 - 14	3/4 - 14	1 1/8	1.96	5.5	6.6	3.5
1 x 1/4 FF	1 - 11 1/2	1/4 - 18	1 3/8	1.96	4.5	5.4	3.3
1 x 3/8 FF	1 - 11 1/2	3/8 - 18	1 3/8	1.96	4.5	5.4	3.3
1 x 1/2 FF	1 - 11 1/2	1/2 - 14	1 3/8	2.09	4.5	5.4	3.3
1 x 3/4 FF	1 - 11 1/2	3/4 - 14	1 3/8	2.09	4.5	5.4	3.3
1 FF	1 - 11 1/2	1 - 11 1/2	1 3/8	2.34	4.5	5.4	3.0
1 1/4 x 1 FF	1 1/4 - 11 1/2	1 - 11 1/2	1 3/4	2.45	3.0	3.6	2.3
1 1/4 FF	1 1/4 - 11 1/2	1 1/4 - 11 1/2	1 3/4	2.48	3.0	3.6	2.3
1 1/2 x 1 FF	1 1/2 - 11 1/2	1 - 11 1/2	2	2.55	3.0	3.6	2.3
1 1/2 FF	1 1/2 - 11 1/2	1 1/2 - 11 1/2	2	2.61	3.0	3.6	2.3
2 x 1 1/2 FF	2 - 11 1/2	1 1/2 - 11 1/2	2 1/2	2.79	2.0	2.4	1.5
2 FF	2 - 11 1/2	2 - 11 1/2	2 1/2	2.83	2.0	2.4	1.5

FFF

Long Pipe Nipple
NPTF / NPTF



TUBE FITTING PART #	END SIZE		C HEX (in.)	L (in.)	Dynamic Pressure (x 1,000 PSI)		
	1	2			-S	-SS	-B
	NPTF	NPTF					
1/8 x 1.5 FFF	1/8 - 27	1/8 - 27	7/16	1.5	6.0	7.2	3.9
1/8 x 2.0 FFF	1/8 - 27	1/8 - 27	7/16	2.0	6.0	7.2	3.9
1/8 x 2.5 FFF	1/8 - 27	1/8 - 27	7/16	2.5	6.0	7.2	3.9
1/8 x 3.0 FFF	1/8 - 27	1/8 - 27	7/16	3.0	6.0	7.2	3.9
1/4 x 1.5 FFF	1/4 - 18	1/4 - 18	5/8	1.5	6.0	7.2	3.9
1/4 x 2.0 FFF	1/4 - 18	1/4 - 18	5/8	2.0	6.0	7.2	3.9
1/4 x 2.5 FFF	1/4 - 18	1/4 - 18	5/8	2.5	6.0	7.2	3.9
1/4 x 3.0 FFF	1/4 - 18	1/4 - 18	5/8	3.0	6.0	7.2	3.9
1/4 x 4.0 FFF	1/4 - 18	1/4 - 18	5/8	4.0	6.0	7.2	3.9
3/8 x 2.0 FFF	3/8 - 18	3/8 - 18	3/4	2.0	6.0	7.2	3.3
3/8 x 3.0 FFF	3/8 - 18	3/8 - 18	3/4	3.0	6.0	7.2	3.3
3/8 x 3.5 FFF	3/8 - 18	3/8 - 18	3/4	3.5	6.0	7.2	3.3
3/8 x 4.0 FFF	3/8 - 18	3/8 - 18	3/4	4.0	6.0	7.2	3.3
1/2 x 2.0 FFF	1/2 - 14	1/2 - 14	7/8	2.0	6.0	7.2	3.3
1/2 x 2.5 FFF	1/2 - 14	1/2 - 14	7/8	2.5	6.0	7.2	3.3
1/2 x 3.0 FFF	1/2 - 14	1/2 - 14	7/8	3.0	6.0	7.2	3.9
1/2 x 4.0 FFF	1/2 - 14	1/2 - 14	7/8	4.0	6.0	7.2	3.3
1/2 x 6.0 FFF	1/2 - 14	1/2 - 14	7/8	6.0	6.0	7.2	3.3
3/4 x 3.0 FFF	3/4 - 14	3/4 - 14	1 1/8	3.0	5.5	6.6	3.3
1 x 3.0 FFF	1 - 11 1/2	1 - 11 1/2	1 3/8	3.0	4.5	5.4	3.3

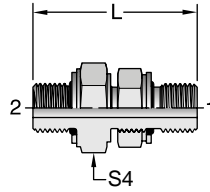
Note: All steel "FF" fittings have a 30° chamfer for sealing with NPSM swivel type fittings.

Dimensions and pressures for reference only, subject to change.



F80HA80

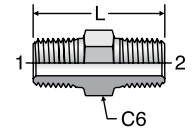
Metric Union
Metric-ORR / Metric-ORR
(for ISO 9974 / DIN 3852-1 Port)



TUBE FITTING PART #	End Size		S4 Hex (mm)	L (mm)	Dynamic Pressure (x 1,000 PSI)		
	1 Metric Str	2 Metric Str			S	SS	B
M10F80HA80	M10X1	M10X1	16	33.8	6.0		
M12F80HA80	M12X1.5	M12X1.5	19	36.8	6.0		
M14F80HA80	M14X1.5	M14X1.5	22	37.3	6.0		
M16F80HA80	M16X1.5	M16X1.5	22	46.0	5.0		
M18F80HA80	M18X1.5	M18X1.5	27	48.8	5.0		
M20M18F80HA80	M20X1.5	M18X1.5	27	49.8	4.0		
M22F80HA80	M22X1.5	M22X1.5	27	52.6	4.0		
M27F80HA80	M27X2	M27X2	32	62.0	4.0		
M33F80HA80	M33X2	M33X2	41	62.0	3.0		

FF33M

BSPT Pipe Nipple
BSPT / BSPT



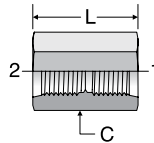
TUBE FITTING PART #	END SIZE		C6 HEX (mm)	L (mm)	Dynamic Pressure (x 1,000 PSI)		
	1 BSPT	2 BSPT			S	SS	B
1/8FF33M	1/8 - 28	1/8 - 28	11	27	6.0	6.0	3.3
1/4x1/8FF33M	1/4 - 19	1/8 - 28	14	32	6.0	6.0	3.3
1/4FF33M	1/4 - 19	1/4 - 19	14	37	6.0	6.0	3.3
3/8x1/4FF33M	3/8 - 19	1/4 - 19	17	37	6.0	6.0	3.3
3/8FF33M	3/8 - 19	3/8 - 19	17	37	6.0	6.0	3.3
1/2FF33M	1/2 - 14	1/2 - 14	22	48	6.0	6.0	3.3
1/2x3/8FF33M	1/2 - 14	3/8 - 19	22	43	6.0	6.0	3.3
3/4FF33M	3/4 - 14	3/4 - 14	27	50	5.5	5.5	3.3
3/4x1/2FF33M	3/4 - 14	1/2 - 14	27	50	5.5	5.5	3.3
1X3/4FF33M	1 - 11	3/4 - 14	36	55	4.5	4.5	2.9
1FF33M	1 - 11	1 - 11	36	59	4.5	4.5	2.9

TABLE OF CONTENTS

VISUAL INDEX

G5HG5

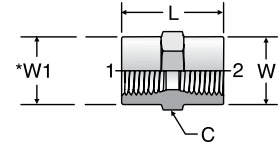
Straight Thread Coupling
Female SAE / Female SAE



TUBE FITTING PART #	END SIZE		C HEX (in.)	L (in.)	Dynamic Pressure (x 1,000 PSI)		
	1 UN/UNF-2B	2 UN/UNF-2B			-S	-SS	-B
4 G5HG5	7/16 - 20	7/16 - 20	11/16	1.13	7.0	6.0	3.3
6 G5HG5	9/16 - 18	9/16 - 18	13/16	1.26	6.0	6.0	3.3
8 G5HG5	3/4 - 16	3/4 - 16	1	1.42	5.0	5.0	3.3
10 G5HG5	7/8 - 14	7/8 - 14	1 3/16	1.60	4.5	4.5	2.9
12 G5HG5	1 1/16 - 12	1 1/16 - 12	1 3/8	1.85	4.5	4.5	2.9
16 G5HG5	1 5/16 - 12	1 5/16 - 12	1 5/8	1.85	3.5	3.5	2.2

GG

Pipe Coupling
NPTF / NPTF



SAE 140138
HPD Base # 0202

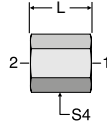
TUBE FITTING PART #	END SIZE		C HEX (in.)	L (in.)	W1 (in.)	W (in.)	Dynamic Pressure (x 1,000 PSI)		
	1 NPTF	2 NPTF					-S	-SS	-B
1/8 GG	1/8 - 27	1/8 - 27	5/8	0.75	0.63	0.63	6.0	6.0	3.9
1/4 x 1/8 GG	1/4 - 18	1/8 - 27	3/4	0.94	0.75	0.63	6.0	6.0	3.9
1/4 GG	1/4 - 18	1/4 - 18	3/4	1.13	0.75	0.75	6.0	6.0	3.9
3/8 x 1/8 GG	3/8 - 18	1/8 - 27	7/8	1.03	0.88	0.63	6.0	6.0	3.9
3/8 x 1/4 GG	3/8 - 18	1/4 - 18	7/8	1.13	0.88	0.75	6.0	6.0	3.9
3/8 GG	3/8 - 18	3/8 - 18	7/8	1.13	0.88	0.88	6.0	6.0	3.9
1/2 x 1/8 GG	1/2 - 14	1/8 - 27	1 1/8	1.06	1.13	0.63	6.0	6.0	3.2
1/2 x 1/4 GG	1/2 - 14	1/4 - 18	1 1/8	1.38	1.13	0.75	5.0	6.0	3.2
1/2 x 3/8 GG	1/2 - 14	3/8 - 18	1 1/8	1.50	1.13	0.88	5.0	6.0	3.2
1/2 GG	1/2 - 14	1/2 - 14	1 1/8	1.50	1.13	1.13	5.0	6.0	3.2
3/4 x 1/4 GG	3/4 - 14	1/4 - 18	1 3/8	1.55	1.36	0.75	4.0	4.8	3.1
3/4 x 1/2 GG	3/4 - 14	1/2 - 14	1 3/8	1.88	1.36	1.13	4.0	4.8	3.1
3/4 GG	3/4 - 14	3/4 - 14	1 3/8	1.53	1.38	1.38	4.0	4.8	2.6
1 GG	1 - 11 1/2	1 - 11 1/2	1 5/8	1.89	1.63	1.63	3.0	3.6	1.9
1 x 1/2 GG	1 - 11 1/2	1/2 - 14	1 5/8	1.77	1.63	1.13	3.0	3.6	1.9
1 x 3/4 GG	1 - 11 1/2	3/4 - 14	1 5/8	1.77	1.63	1.38	3.0	3.6	1.9
1 1/4 GG	1 1/4 - 11 1/2	1 1/4 - 11 1/2	2	1.93	2.00	2.00	2.5	3.0	1.9
1 1/4 x 1 GG	1 1/4 - 11 1/2	1 - 11 1/2	2	1.93	2.00	1.63	2.5	3.0	1.9
1 1/2 GG	1 1/2 - 11 1/2	1 1/2 - 11 1/2	2 3/8	1.93	2.38	2.38	2.0	2.4	1.5
1 1/2 x 1 1/4 GG	1 1/2 - 11 1/2	1 1/4 - 11 1/2	2 3/8	1.93	2.37	2.37	2.0	2.4	1.5
2 GG	2 - 11 1/2	2 - 11 1/2	2 7/8	1.97	2.88	2.88	2.0	2.4	1.5

Dimensions and pressures for reference only, subject to change.



G8HG8

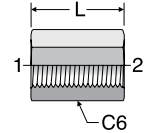
Metric Female Union
Metric-ORR / Metric-ORR
(for ISO 9974 / DIN 3852-1 Port)



TUBE FITTING PART #	End Size		S4 Hex (mm)	L (mm)	Dynamic Pressure (x 1,000 PSI)		
	1 Metric Str	2 Metric Str			S		
M10G8HG8	M10X1	M10X1	17	19	6.0		
M14G8HG8	M14X1.5	M14X1.5	22	28	6.0		
M16G8HG8	M16X1.5	M16X1.5	24	29	6.0		
M18G8HG8	M18X1.5	M18X1.5	27	29	6.0		
M20G8HG8	M20X1.5	M20X1.5	32	32	5.0		
M27G8HG8	M27X2	M27X2	38	38	5.0		
M33G8HG8	M33X2	M33X2	46	44	5.0		

GG44M

BSPP Female Union
BSPP / BSPP



TUBE FITTING PART #	END SIZE		C6 HEX (mm)	L (mm)	Dynamic Pressure (x 1,000 PSI)		
	1 BSPP	2 BSPP			S	SS	B
1/8GG44M	1/8 - 28	1/8 - 28	14	19.0	6.0	6.0	3.3
1/4X1/8GG44M	1/4 - 19	1/8 - 28	17	24.0	6.0	6.0	3.3
1/4GG44M	1/4 - 19	1/4 - 19	17	28.0	6.0	6.0	3.3
3/8GG44M	3/8 - 19	3/8 - 19	22	28.0	6.0	6.0	3.3
3/8x1/4GG44M	3/8 - 19	1/4 - 19	22	28.0	6.0	6.0	3.3
1/2x3/8GG44M	1/2 - 14	3/8 - 19	27	31.0	5.0	5.0	3.3
1/2GG44M	1/2 - 14	1/2 - 14	27	32.5	5.0	5.0	3.3
1GG44M	1 - 11	1 - 11	46	42.0	3.0	3.0	1.9

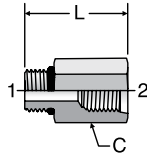
TABLE OF CONTENTS

VISUAL INDEX

F

F50G5

Straight Thread Reducer / Expander
SAE-ORB / SAE-ORB

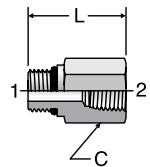


SAE 090136
HPD Base # 0510

TUBE FITTING PART #	END SIZE		C HEX (in.)	L (in.)	Dynamic Pressure (x 1,000 PSI)		
	1 UN/UNF-2A	2 UN/UNF-2B			-S	-SS	-B
2-4 F50G5	5/16 - 24	7/16 - 20	11/16	1.03	7.5	7.5	3.3
4-4 F50G5	7/16 - 20	7/16 - 20	11/16	1.08	7.5	7.5	3.3
4-6 F50G5	7/16 - 20	9/16 - 18	13/16	1.16	6.0	6.0	3.3
6-4 F50G5	9/16 - 18	7/16 - 20	11/16	1.03	6.0	6.0	3.3
6-6 F50G5	9/16 - 18	9/16 - 18	13/16	1.16	6.0	6.0	3.3
6-8 F50G5	9/16 - 18	3/4 - 16	1 1/16	1.38	6.0	6.0	3.3
8-4 F50G5	3/4 - 16	7/16 - 20	7/8	1.13	6.0	6.0	3.3
8-6 F50G5	3/4 - 16	9/16 - 18	7/8	1.13	6.0	6.0	3.3
8-10 F50G5	3/4 - 16	7/8 - 14	1 1/8	1.56	4.5	4.5	2.9
10-4 F50G5	7/8 - 14	7/16 - 20	1	0.81	5.0	5.0	3.3
10-6 F50G5	7/8 - 14	9/16 - 18	1	1.26	5.0	5.0	3.3
10-8 F50G5	7/8 - 14	3/4 - 16	1	1.31	5.0	5.0	3.3
10-12 F50G5	7/8 - 14	1 1/16 - 12	1 3/8	1.69	4.5	4.5	2.9
12-4 F50G5	1 1/16 - 12	7/16 - 20	1 1/4	1.00	5.0	5.0	3.3
12-6 F50G5	1 1/16 - 12	9/16 - 18	1 1/4	1.00	5.0	5.0	3.3
12-8 F50G5	1 1/16 - 12	3/4 - 16	1 1/4	1.45	5.0	5.0	3.3
12-10 F50G5	1 1/16 - 12	7/8 - 14	1 1/4	1.53	5.0	5.0	3.3
12-16 F50G5	1 1/16 - 12	1 5/16 - 12	1 5/8	1.88	3.5	3.5	2.2
16-6 F50G5	1 5/16 - 12	9/16 - 18	1 1/2	1.00	4.5	4.5	2.9
16-8 F50G5	1 5/16 - 12	3/4 - 16	1 1/2	1.00	4.5	4.5	2.9
16-10 F50G5	1 5/16 - 12	7/8 - 14	1 1/2	1.00	4.5	4.5	2.9
16-12 F50G5	1 5/16 - 12	1 1/16 - 12	1 1/2	1.75	4.5	4.5	2.9
16-20 F50G5	1 5/16 - 12	1 5/8 - 12	2 1/8	1.97	3.0	3.0	1.9
20-6 F50G5	1 5/8 - 12	9/16 - 18	1 7/8	1.00	4.0	4.0	2.6
20-8 F50G5	1 5/8 - 12	3/4 - 16	1 7/8	1.00	4.0	4.0	2.6
20-10 F50G5	1 5/8 - 12	7/8 - 14	1 7/8	1.00	4.0	4.0	2.6
20-12 F50G5	1 5/8 - 12	1 1/16 - 12	1 7/8	1.00	4.0	4.0	2.6
20-16 F50G5	1 5/8 - 12	1 5/16 - 12	1 7/8	1.72	4.0	4.0	2.6
20-24 F50G5	1 5/8 - 12	1 7/8 - 12	2 1/2	1.88	3.0	3.0	1.9
24-6 F50G5	1 7/8 - 12	9/16 - 18	2 1/8	1.00	3.0	3.0	1.9
24-12 F50G5	1 7/8 - 12	1 1/16 - 12	2 1/8	1.00	3.0	3.0	1.9
24-16 F50G5	1 7/8 - 12	1 5/16 - 12	2 1/8	1.00	3.0	3.0	1.9
24-20 F50G5	1 7/8 - 12	1 5/8 - 12	2 1/8	1.75	3.0	3.0	1.9
32-20 F50G5	2 1/2 - 12	1 5/8 - 12	2 3/4	1.00	2.0	2.0	1.3
32-24 F50G5	2 1/2 - 12	1 7/8 - 12	2 3/4	1.80	2.0	2.0	1.3

F50G

Female Pipe Adapter
SAE-ORB / NPTF



SAE 090156

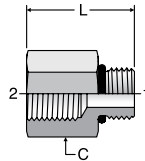
TUBE FITTING PART #	END SIZE		C HEX (in.)	L (in.)	Dynamic Pressure (x 1,000 PSI)		
	1 UN/UNF-2A	2 NPTF			-S	-SS	-B
2-1/8 F50G	5/16 - 24	1/8 - 27	9/16	0.91	6.0	6.0	3.3
4-1/8 F50G	7/16 - 20	1/8 - 27	9/16	1.00	6.0	6.0	3.3
4-1/4 F50G	7/16 - 20	1/4 - 18	3/4	1.16	6.0	6.0	3.3
5-1/8 F50G	1/2 - 20	1/8 - 27	5/8	1.06	6.0	6.0	3.3
5-1/4 F50G	1/2 - 20	1/4 - 18	3/4	1.19	6.0	6.0	3.3
6-1/8 F50G	9/16 - 18	1/8 - 27	11/16	1.00	6.0	6.0	3.3
6-1/4 F50G	9/16 - 18	1/4 - 18	3/4	1.16	6.0	6.0	3.3
6-3/8 F50G	9/16 - 18	3/8 - 18	7/8	1.28	6.0	6.0	3.3
6-1/2 F50G	9/16 - 18	1/2 - 14	1 1/8	1.53	5.0	6.0	3.3
8-1/8 F50G	3/4 - 16	1/8 - 27	7/8	0.80	6.0	6.0	3.3
8-1/4 F50G	3/4 - 16	1/4 - 18	7/8	1.13	6.0	6.0	3.3
8-3/8 F50G	3/4 - 16	3/8 - 18	7/8	1.28	6.0	6.0	3.3
8-1/2 F50G	3/4 - 16	1/2 - 14	1 1/8	1.50	5.0	6.0	3.3
10-1/4 F50G	7/8 - 14	1/4 - 18	1	0.81	5.0	6.0	3.3
10-3/8 F50G	7/8 - 14	3/8 - 18	1	1.31	5.0	6.0	3.3
10-1/2 F50G	7/8 - 14	1/2 - 14	1 1/8	1.53	5.0	6.0	3.3
10-3/4 F50G	7/8 - 14	3/4 - 14	1 3/8	1.63	4.0	4.0	2.6
12-1/4 F50G	1 1/16 - 12	1/4 - 18	1 1/4	1.00	6.0	6.0	3.3
12-3/8 F50G	1 1/16 - 12	3/8 - 18	1 1/4	1.34	5.0	6.0	3.3
12-1/2 F50G	1 1/16 - 12	1/2 - 14	1 1/4	1.41	5.0	6.0	3.3
12-3/4 F50G	1 1/16 - 12	3/4 - 14	1 3/8	1.72	4.0	4.8	3.1
14-1/2 F50G	1 3/16 - 12	1/2 - 14	1 3/8	1.06	5.0	5.0	3.3
14-3/4 F50G	1 3/16 - 12	3/4 - 14	1 3/8	1.69	4.0	4.0	2.6
16-1/2 F50G	1 5/16 - 12	1/2 - 14	1 1/2	1.00	5.0	6.0	3.3
16-3/4 F50G	1 5/16 - 12	3/4 - 14	1 1/2	1.50	4.0	4.8	2.6
16-1 F50G	1 5/16 - 12	1 - 11 1/2	1 5/8	1.88	3.0	3.6	1.9
20-1 F50G	1 5/8 - 12	1 - 11 1/2	1 7/8	1.00	3.0	3.6	1.9
20-1 1/2 F50G	1 5/8 - 12	1 1/2 - 11 1/2	2 1/4	2.16	2.5	3.0	1.6
20-1 1/4 F50G	1 5/8 - 12	1 1/4 - 11 1/2	2	1.97	3.0	3.0	1.9
24-1 F50G	1 7/8 - 12	1 - 11 1/2	2 1/8	1.00	3.0	3.6	1.9
24-1 1/4 F50G	1 7/8 - 12	1 1/4 - 11 1/2	2 1/8	1.94	2.5	2.5	1.6
24-1 1/2 F50G	1 7/8 - 12	1 1/2 - 11 1/2	2 1/4	2.00	2.0	2.4	1.3
32-2 F50G	2 1/2 - 12	2 - 11 1/2	2 7/8	2.06	2.0	2.4	1.3

Dimensions and pressures for reference only, subject to change.



F50HG8

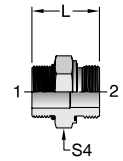
Conversion Adapter
SAE-ORB / Metric



TUBE FITTING PART #	END SIZE		C HEX (in.)	L (in.)	Dynamic Pressure (x 1,000 PSI)		
	1 UN/UNF-2A	2 METRIC STR			S	SS	B
4M10F5OHG8	7/16 - 20	M10X1	5/8	0.95	6.0	6.0	3.3
4M12F5OHG8	7/16 - 20	M12X1.5	3/4	1.14	6.0	6.0	3.3
6M14F5OHG8	9/16 - 18	M14X1.5	13/16	1.17	6.0	6.0	3.3
6M16F5OHG8	9/16 - 18	M16X1.5	15/16	1.17	6.0	6.0	3.3
8M16F5OHG8	3/4 - 16	M16X1.5	15/16	1.30	6.0	6.0	3.3
8M18F5OHG8	3/4 - 16	M18X1.5	1	1.30	6.0	6.0	3.3
10M22F5OHG8	7/8 - 14	M22X1.5	1 3/16	1.46	5.0	5.0	3.3
12M27F5OHG8	1 1/16 - 12	M27X2	1 1/2	1.72	5.0	5.0	3.3
16M33F5OHG8	1 5/16 - 12	M33X2	1 3/4	1.81	5.0	5.0	3.3

F50HF42

Conversion Adapter
SAE-ORB / BSPP-ED



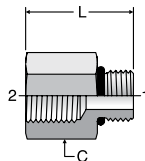
TUBE FITTING PART #	End Size		S4 Hex (mm)	L (mm)	Dynamic Pressure (x 1,000 PSI)	
	1 UN/UNF-2A	2 BSPP			S	B
4-1/8F5OHF42ED	7/16-20	1/8-28	17	27.2	9.2	
4-1/4F5OHF42ED	7/16-20	1/4-19	19	31.8	9.2	
5-1/4F5OHF42ED	1/2-20	1/4-19	19	31.4	9.2	
6-1/4F5OHF42ED	9/16-18	1/4-19	19	32.0	9.2	
6-3/8F5OHF42ED	9/16-18	3/8-19	22	32.5	9.2	
8-1/4F5OHF42ED	3/4-16	1/4-19	22	34.9	9.2	
8-3/8F5OHF42ED	3/4-16	3/8-19	22	36.5	9.2	
8-1/2F5OHF42ED	3/4-16	1/2-14	27	40.0	6.0	
10-1/2F5OHF42ED	7/8-14	1/2-14	27	42.0	6.0	
12-1/2F5OHF42ED	1 1/16-12	1/2-14	32	45.0	6.0	
12-3/4F5OHF42ED	1 1/16-12	3/4-14	32	47.0	6.0	
16-3/4F5OHF42ED	1 5/16-12	3/4-14	38	48.0	6.0	
16-1F5OHF42ED	1 5/16-12	1-11	41	51.0	6.0	
20-11/4F5OHF42ED	1 5/8-12	1 1/4-11	50	54.0	6.0	
24-11/2F5OHF42ED	1 7/8-12	1 1/2-11	55	56.0	5.0	

TABLE OF CONTENTS

VISUAL INDEX

F50HG4

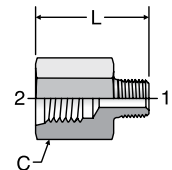
Conversion Adapter
SAE-ORB / BSPP



TUBE FITTING PART #	END SIZE		C HEX (in.)	L (in.)	Dynamic Pressure (x 1,000 PSI)		
	1 UN/UNF-2A	2 BSPP			S	SS	B
4-1/8F5OHG4	7/16 - 20	1/8 - 28	5/8	0.96	6.0	6.0	3.3
4-1/4F5OHG4	7/16 - 20	1/4 - 19	3/4	1.16	6.0	6.0	3.3
6-1/4F5OHG4	9/16 - 18	1/4 - 19	3/4	1.19	6.0	6.0	3.3
6-3/8F5OHG4	9/16 - 18	3/8 - 19	7/8	1.19	6.0	6.0	3.3
8-1/4F5OHG4	3/4 - 16	1/4 - 19	7/8	1.32	6.0	6.0	3.3
8-3/8F5OHG4	3/4 - 16	3/8 - 19	15/16	1.32	6.0	6.0	3.3
10-1/2F5OHG4	7/8 - 14	1/2 - 14	1 1/8	1.52	5.0	5.0	3.3
12-3/4F5OHG4	1 1/16 - 12	3/4 - 14	1 7/16	1.74	4.0	4.0	2.6
16-1F5OHG4	1 5/16 - 12	1 - 11	1 7/8	1.87	3.0	3.0	1.9

FHG5

Female Straight Thread Adapter
NPTF / SAE-ORB



HPD Base # 0110

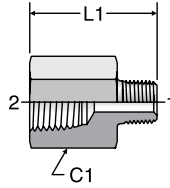
TUBE FITTING PART #	END SIZE		C HEX (in.)	L (in.)	Dynamic Pressure (x 1,000 PSI)		
	1 NPTF	2 UN/UNF-2B			-S	-SS	-B
1/8-4 FHG5	1/8 - 27	7/16 - 20	11/16	1.06	6.0	6.0	3.3
1/8-5 FHG5	1/8 - 27	1/2 - 20	3/4	1.09	6.0	6.0	3.3
1/4-6 FHG5	1/4 - 18	9/16 - 18	3/4	1.36	6.0	6.0	3.3
3/8-6 FHG5	3/8 - 18	9/16 - 18	3/4	1.42	6.0	6.0	3.3
3/8-8 FHG5	3/8 - 18	3/4 - 16	1	1.50	5.0	5.0	3.3
1/2-6 FHG5	1/2 - 14	9/16 - 18	7/8	1.58	6.0	6.0	3.3
1/2-8 FHG5	1/2 - 14	3/4 - 16	1	1.66	5.0	5.0	3.3
1/2-10 FHG5	1/2 - 14	7/8 - 14	1 1/4	1.75	4.5	4.5	2.9
3/4-8 FHG5	3/4 - 14	3/4 - 16	1 1/8	1.13	4.5	4.5	2.9
3/4-12 FHG5	3/4 - 14	1 1/16 - 12	1 3/8	1.97	4.5	4.5	2.9
1-16 FHG5	1 - 11 1/2	1 5/16 - 12	1 5/8	2.13	3.5	3.5	2.2

Dimensions and pressures for reference only, subject to change.

FG

Expander / Adapter
NPTF / NPTF

SAE 140139
HPD Base # 0201

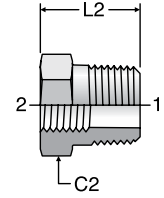


TUBE FITTING PART #	END SIZE		C1 HEX (in.)	L1 (in.)	Dynamic Pressure (x 1,000 PSI)		
	1 NPTF	2 NPTF			-S	-SS	-B
	1/8 x 1/16 FG	1/16 - 27					
1/8 FG	1/8 - 27	1/8 - 27	5/8	1.03	6.0	6.0	3.3
1/4 x 1/8 FG	1/8 - 27	1/4 - 18	3/4	1.21	6.0	6.0	3.9
1/4 FG	1/4 - 18	1/4 - 18	3/4	1.39	6.0	6.0	3.9
3/8 x 1/8 FG	1/8 - 27	3/8 - 18	7/8	1.25	6.0	6.0	3.3
3/8 x 1/4 FG	1/4 - 18	3/8 - 18	7/8	1.44	6.0	6.0	3.9
3/8 FG	3/8 - 18	3/8 - 18	7/8	1.44	6.0	6.0	3.9
1/2 x 1/8 FG	1/8 - 27	1/2 - 14	1 1/8	1.50	5.0	6.0	3.2
1/2 x 1/4 FG	1/4 - 18	1/2 - 14	1 1/8	1.69	5.0	6.0	3.2
1/2 x 3/8 FG	3/8 - 18	1/2 - 14	1 1/8	1.69	5.0	6.0	3.2
1/2 FG	1/2 - 14	1/2 - 14	1 1/8	1.87	5.0	6.0	3.2
3/4 FG	3/4 - 14	3/4 - 14	1 3/8	1.93	4.0	4.8	2.6
3/4 x 1/4 FG	1/4 - 18	3/4 - 14	1 3/8	1.75	4.0	4.8	2.6
3/4 x 3/8 FG	3/8 - 18	3/4 - 14	1 3/8	1.75	4.0	4.8	2.6
3/4 x 1/2 FG	1/2 - 14	3/4 - 14	1 3/8	1.93	4.0	4.8	2.6
1 FG	1 - 11 1/2	1 - 11 1/2	1 5/8	2.37	3.0	3.6	2.3
1 x 1/4 FG	1/4 - 18	1 - 11 1/2	1 5/8	2.01	3.0	3.6	2.3
1 x 1/2 FG	1/2 - 14	1 - 11 1/2	1 5/8	2.19	3.0	3.6	2.3
1 x 3/4 FG	3/4 - 14	1 - 11 1/2	1 5/8	2.19	3.0	3.6	2.3
1 1/4 FG	1 1/4 - 11 1/2	1 1/4 - 11 1/2	2	2.50	2.5	3.0	1.9
1 1/4 x 1 FG	1 - 11 1/2	1 1/4 - 11 1/2	2	2.47	2.5	3.0	1.9
1 1/2 x 1 FG	1 - 11 1/2	1 1/2 - 11 1/2	2 3/8	2.47	2.0	2.4	1.5
1 1/2 x 1 1/4 FG	1 1/4 - 11 1/2	1 1/2 - 11 1/2	2 3/8	2.50	2.0	2.4	1.5
2 FG	2 - 11 1/2	2 - 11 1/2	2 7/8	2.66	2.0	2.4	1.5

PTR

Pipe Thread Reducer
NPTF / NPTF

SAE 140140
HPD Base # 0102



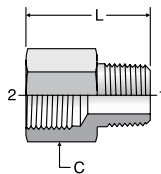
TUBE FITTING PART #	END SIZE		C2 HEX (in.)	L2 (in.)	Dynamic Pressure (x 1,000 PSI)		
	1 NPTF	2 NPTF			-S	-SS	-B
	1/4 x 1/8 PTR	1/4 - 18					
3/8 x 1/8 PTR	3/8 - 18	1/8 - 27	3/4	0.86	6.0	6.0	3.9
3/8 x 1/4 PTR	3/8 - 18	1/4 - 18	3/4	0.86	6.0	6.0	3.9
1/2 x 1/8 PTR	1/2 - 14	1/8 - 27	7/8	1.11	6.0	6.0	3.2
1/2 x 1/4 PTR	1/2 - 14	1/4 - 18	7/8	1.11	6.0	6.0	3.2
1/2 x 3/8 PTR	1/2 - 14	3/8 - 18	7/8	1.11	6.0	6.0	3.2
3/4 x 1/8 PTR	3/4 - 14	1/8 - 27	1 1/8	1.17	5.5	6.0	3.3
3/4 x 1/4 PTR	3/4 - 14	1/4 - 18	1 1/8	1.17	5.5	6.0	3.7
3/4 x 3/8 PTR	3/4 - 14	3/8 - 18	1 1/8	1.17	5.5	6.0	3.7
3/4 x 1/2 PTR	3/4 - 14	1/2 - 14	1 1/8	1.17	5.0	6.0	3.3
1 x 1/8 PTR	1 - 11 1/2	1/8 - 27	1 3/8	1.36	4.5	5.4	3.3
1 x 1/4 PTR	1 - 11 1/2	1/4 - 18	1 3/8	1.36	4.5	5.4	3.3
1 x 3/8 PTR	1 - 11 1/2	3/8 - 18	1 3/8	1.36	4.5	5.4	3.0
1 x 1/2 PTR	1 - 11 1/2	1/2 - 14	1 3/8	1.36	4.5	5.4	3.0
1 x 3/4 PTR	1 - 11 1/2	3/4 - 14	1 3/8	1.36	4.0	4.8	2.7
1 1/4 x 1/4 PTR	1 1/4 - 11 1/2	1/4 - 18	1 3/4	1.47	3.0	3.6	2.3
1 1/4 x 3/8 PTR	1 1/4 - 11 1/2	3/8 - 18	1 3/4	1.47	3.0	3.6	2.3
1 1/4 x 1/2 PTR	1 1/4 - 11 1/2	1/2 - 14	1 3/4	1.47	3.0	3.6	2.3
1 1/4 x 3/4 PTR	1 1/4 - 11 1/2	3/4 - 14	1 3/4	1.47	3.0	3.6	2.3
1 1/4 x 1 PTR	1 1/4 - 11 1/2	1 - 11 1/2	1 3/4	1.47	3.0	3.6	2.3
1 1/2 x 1/4 PTR	1 1/2 - 11 1/2	1/4 - 18	2	1.52	3.0	3.6	2.3
1 1/2 x 3/8 PTR	1 1/2 - 11 1/2	3/8 - 18	2	1.58	3.0	3.6	2.3
1 1/2 x 1/2 PTR	1 1/2 - 11 1/2	1/2 - 14	2	1.58	3.0	3.6	2.3
1 1/2 x 3/4 PTR	1 1/2 - 11 1/2	3/4 - 14	2	1.58	3.0	3.6	2.3
1 1/2 x 1 PTR	1 1/2 - 11 1/2	1 - 11 1/2	2	1.58	3.0	3.6	2.3
1 1/2 x 1 1/4 PTR	1 1/2 - 11 1/2	1 1/4 - 11 1/2	2	1.58	2.5	3.0	1.9
2 x 1/2 PTR	2 - 11 1/2	1/2 - 14	2 1/2	1.75	2.0	2.4	1.5
2 x 3/4 PTR	2 - 11 1/2	3/4 - 14	2 1/2	1.75	2.0	2.4	1.5
2 x 1 PTR	2 - 11 1/2	1 - 11 1/2	2 1/2	1.75	2.0	2.4	1.5
2 x 1 1/4 PTR	2 - 11 1/2	1 1/4 - 11 1/2	2 1/2	1.75	2.0	2.4	1.5
2 x 1 1/2 PTR	2 - 11 1/2	1 1/2 - 11 1/2	2 1/2	1.75	2.0	2.4	1.5

TABLE OF CONTENTS
VISUAL INDEX

F

FHG8

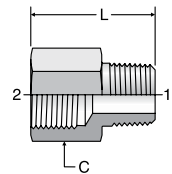
Conversion Adapter
NPTF / Metric



TUBE FITTING PART #	END SIZE		C HEX (in.)	L (in.)	Dynamic Pressure (x 1,000 PSI)		
	1 NPTF	2 METRIC STR			S	SS	B
	1/8M10FHG8	1/8 - 27					
1/8M12FHG8	1/8 - 27	M12X1.5	3/4	1.16	6.0	6.0	3.3
1/4M14FHG8	1/4 - 18	M14X1.5	13/16	1.35	6.0	6.0	3.3
1/4M16FHG8	1/4 - 18	M16X1.5	15/16	1.37	6.0	6.0	3.3
3/8M18FHG8	3/8 - 18	M18X1.5	1	1.36	6.0	6.0	3.3
1/2M22FHG8	1/2 - 14	M22X1.5	1 3/16	1.65	6.0	5.0	3.3
3/4M27FHG8	3/4 - 14	M27X2	1 1/2	1.77	5.5	4.5	2.9

FHG4

Conversion Adapter
NPTF / BSPP



TUBE FITTING PART #	END SIZE		C HEX (in.)	L (in.)	Dynamic Pressure (x 1,000 PSI)		
	1 NPTF	2 BSPP			-S	-SS	-B
	1/4X1/4FHG4	1/4 - 18					
1/4X3/8FHG4	1/4 - 18	3/8 - 19	13/16	1.40	6.0	6.0	3.3
3/8X1/4FHG4	3/8 - 18	1/4 - 19	3/4	1.31	6.0	6.0	3.3
3/8X3/8FHG4	3/8 - 18	3/8 - 19	1	1.34	6.0	6.0	3.3
1/2X3/8FHG4	1/2 - 14	3/8 - 19	15/16	1.50	6.0	6.0	3.3
1/2X1/2FHG4	1/2 - 14	1/2 - 14	1 1/8	1.66	5.0	5.0	3.3
3/4X3/4FHG4	3/4 - 14	3/4 - 14	1 7/16	1.75	4.0	4.0	2.6

Dimensions and pressures for reference only, subject to change.



F87OHG87M

Reducer / Expander
ISO 6149 / ISO 6149

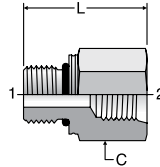


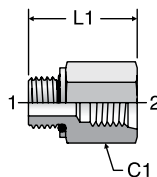
TABLE
OF
CONTENTS

VISUAL
INDEX

TUBE FITTING PART #	END SIZE		C HEX (mm)	L (mm)	Dynamic Pressure (x 1,000 PSI)		
	1 METRIC STR	2 METRIC STR			S	SS	B
	M8M10F87OHG87M	M8X1					
M10M8F87OHG87M	M10X1	M8X1	14	27.5	10.0	7.5	3.3
M10M12F87OHG87M	M10X1	M12X1.5	19	30.0	8.0	6.0	3.3
M12M10F87OHG87M	M12X1.5	M10X1	17	29.5	10.0	6.0	3.3
M12M14F87OHG87M	M12X1.5	M14X1.5	22	32.0	7.0	6.0	3.3
M12M16F87OHG87M	M12X1.5	M16X1.5	24	33.5	6.0	6.0	3.3
M14M12F87OHG87M	M14X1.5	M12X1.5	19	32.0	8.0	6.0	3.3
M14M16F87OHG87M	M14X1.5	M16X1.5	24	33.5	6.0	6.0	3.3
M16M14F87OHG87M	M16X1.5	M14X1.5	22	34.0	7.0	6.0	3.3
M16M18F87OHG87M	M16X1.5	M18X1.5	27	37.0	6.0	6.0	3.3
M18M16F87OHG87M	M18X1.5	M16X1.5	24	37.0	6.0	6.0	3.3
M18M20F87OHG87M	M18X1.5	M20X1.5	30	39.5	6.0	6.0	3.3
M20M18F87OHG87M	M20X1.5	M18X1.5	27	38.5	6.0	6.0	3.3
M20M22F87OHG87M	M20X1.5	M22X1.5	30	39.5	5.0	5.0	3.3
M22M20F87OHG87M	M22X1.5	M20X1.5	27	41.5	5.0	5.0	3.3
M27M22F87OHG87M	M27X2.0	M22X1.5	32	46.0	5.0	5.0	3.3
M27M33F87OHG87M	M27X2.0	M33X2.0	46	52.0	5.0	5.0	3.3
M33M27F87OHG87M	M33X2.0	M27X2.0	41	48.0	5.0	5.0	3.3
M33M42F87OHG87M	M33X2.0	M42X2.0	55	54.0	4.0	4.0	2.6
M42M27F87OHG87M	M42X2.0	M27X2.0	50	54.0	3.0	3.0	1.9
M42M33F87OHG87M	M42X2.0	M33X2.0	50	46.0	3.0	3.0	1.9
M42M48F87OHG87M	M42X2.0	M48X2.0	65	57.0	2.0	2.0	1.3

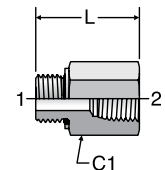
F8OHG5

Conversion Adapter
Metric-ORR / SAE-ORB
(for ISO 9974 / DIN 3852-1 Port)



F8OHG

Conversion Adapter
Metric-ORR / NPTF
(for ISO 9974 / DIN 3852-1 Port)



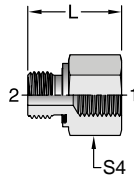
TUBE FITTING PART #	END SIZE		C1 HEX (in.)	L1 (in.)	Dynamic Pressure (x 1,000 PSI)		
	1 METRIC STR	2 UN/UNF-2B			S	SS	B
	M10-4F8OHG5	M10x1					
M10-6F8OHG5	M10X1	9/16 - 18	7/8	1.15	5.0	5.0	3.3
M14-6F8OHG5	M14x1.5	9/16 - 18	13/16	1.19	5.0	5.0	3.3
M16-8F8OHG5	M16x1.5	3/4 - 16	1	1.31	5.0	5.0	3.3
M18-8F8OHG5	M18X1.5	3/4 - 16	1	1.38	3.5	3.5	2.2
M22-10F8OHG5	M22x1.5	7/8 - 14	1 1/8	1.50	3.5	3.5	2.2
M27-12F8OHG5	M27x2	1 1/16 - 12	1 1/4	1.88	3.5	3.5	2.2
M33-16F8OHG5	M33x2	1 5/16 - 12	1 5/8	1.91	3.0	3.0	1.9
M42-20F8OHG5	M42x2	1 5/8 - 12	2	1.91	2.0	2.0	1.3

TUBE FITTING PART #	END SIZE		C1 HEX (in.)	L (in.)	Dynamic Pressure (x 1,000 PSI)		
	1 METRIC STR	2 NPTF			S	SS	B
	M10-1/8F8OHG	M10X1.0					
M12-1/4F8OHG	M12X1.5	1/4 - 18	3/4	1.24	5.0	5.0	3.3
M14-1/4F8OHG	M14X1.5	1/4 - 18	3/4	1.24	5.0	5.0	3.3
M16-3/8F8OHG	M16X1.5	3/8 - 18	7/8	1.36	5.0	5.0	3.3
M16-1/2F8OHG	M16X1.5	1/2 - 14	1 1/8	1.58	5.0	5.0	3.3
M18-3/8F8OHG	M18X1.5	3/8 - 18	15/16	1.42	5.0	5.0	3.3
M18-1/2F8OHG	M18X1.5	1/2 - 14	1 1/8	1.67	5.0	5.0	3.3
M22-1/2F8OHG	M22X1.5	1/2 - 14	1 1/8	1.68	3.5	3.5	2.2
M27-3/4F8OHG	M27X2.0	3/4 - 14	1 3/8	1.87	3.5	3.5	2.2
M33-1F8OHG	M33X2.0	1 - 11 1/2	1 5/8	2.11	3.0	3.0	1.9

Dimensions and pressures for reference only, subject to change.

F82HG8

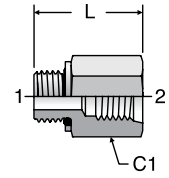
Conversion Adapter
Metric-ED / Metric-ORR
(for ISO 9974 / DIN 3852-1 Port)



TUBE FITTING PART #	End Size		S4 Hex (mm)	L (mm)	Dynamic Pressure (x 1,000 PSI)		
	1 Metric Str	2 Metric Str			S	SS	B
M10-M8F82EDHG8	M10X1	M8X1	17	21.3	5.0		
M10-M12F82EDHG8	M10X1	M12X1.5	17	27.4	5.0		
M12-M10F82EDHG8	M12X1.5	M10X1	19	31.8	5.0		
M12-M14F82EDHG8	M12X1.5	M15X1.5	19	32.8	5.0		
M12-M16F82EDHG8	M12X1.5	M16X1.5	22	33.5	5.0		
M14-M12F82EDHG8	M14X1.5	M12X1.5	22	32.3	5.0		
M14-M16F82EDHG8	M14X1.5	M16X1.5	22	33.3	5.0		
M16-M14F82EDHG8	M16X1.5	M14X1.5	24	32.3	5.0		
M16-M18F82EDHG8	M16X1.5	M18X1.5	24	33.5	5.0		
M18-M16F82EDHG8	M18X1.5	M16X1.5	27	32.8	3.4		
M18-M20F82EDHG8	M18X1.5	M20X1.5	27	36.1	3.4		
M22-M20F82EDHG8	M22X1.5	M20X1.5	30	36.8	3.4		

F4OHG5

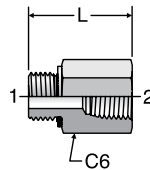
Conversion Adapter
BSPP-ORR / SAE-ORB
(for ISO 1179-1 / DIN 3852-2 Port)



TUBE FITTING PART #	END SIZE		C1 HEX (in.)	L (in.)	Dynamic Pressure (x 1,000 PSI)		
	1 BSPP	2 UN/UNF-2B			-S	-SS	-B
1/8-4F4OHG5	1/8 - 28	7/16 - 20	11/16	1.00	5.0	5.0	3.3
1/4-4F4OHG5	1/4 - 19	7/16 - 20	3/4	1.11	5.0	5.0	3.3
1/4-6F4OHG5	1/4 - 19	9/16 - 18	13/16	1.25	5.0	5.0	3.3
3/8-4F4OHG5	3/8 - 19	7/16 - 20	7/8	1.19	5.0	5.0	3.3
3/8-5F4OHG5	3/8 - 19	1/2 - 20	7/8	1.19	5.0	5.0	3.3
3/8-6F4OHG5	3/8 - 19	9/16 - 18	7/8	1.25	5.0	5.0	3.3
3/8-8F4OHG5	3/8 - 19	3/4 - 16	1	1.33	5.0	5.0	3.3
1/2-10F4OHG5	1/2 - 14	7/8 - 14	1 1/8	1.60	3.5	3.5	2.2
3/4-12F4OHG5	3/4 - 14	1 1/16 - 12	1 3/8	1.74	3.5	3.5	2.2
1-16F4OHG5	1 - 11	1 5/16 - 12	1 3/4	1.92	3.5	3.5	2.2
1 1/4-16F4OHG5	1 1/4 - 11	1 5/16 - 12	2	1.95	2.0	2.0	1.3
1 1/4-20F4OHG5	1 1/4 - 11	1 5/8 - 12	2	1.95	2.0	2.0	1.3

F4OHG

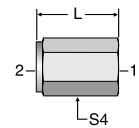
Conversion Adapter
BSPP-ORR / NPTF
(for ISO 1179-1 / DIN 3852-2 Port)



TUBE FITTING PART #	END SIZE		C6 HEX (in.)	L (in.)	Dynamic Pressure (x 1,000 PSI)		
	1 BSPP	2 NPTF			-S	-SS	-B
1/8x1/8F4OHG	1/8 - 28	1/8 - 27	5/8	0.97	5.0	5.0	3.3
1/4x1/4F4OHG	1/4 - 19	1/4 - 18	3/4	1.28	5.0	5.0	3.3
3/8x3/8F4OHG	3/8 - 19	3/8 - 18	7/8	1.33	5.0	5.0	3.3
1/2x1/2F4OHG	1/2 - 14	1/2 - 14	1 1/8	1.73	3.5	3.5	2.2
3/4x3/4F4OHG	3/4 - 14	3/4 - 14	1 3/8	1.77	3.5	3.5	2.2
1x1F4OHG	1 - 11	1 - 11 1/2	1 3/4	2.17	3.0	3.0	1.9

GHG4

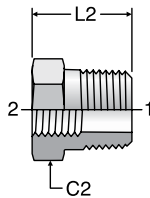
Female Pipe Adapter
BSPP / NPTF



TUBE FITTING PART #	End Size		S4 Hex (in.)	L (in.)	Dynamic Pressure (x 1,000 PSI)	
	1 NPTF	2 BSPP			S	B
1/4 GHG4	1/4-18	1/4-19	3/4	1.23	6.0	
3/8 GHG4	3/8-18	3/8-19	7/8	1.26	6.0	
1/2 GHG4	1/2-14	1/2-14	1 1/8	1.50	5.0	
3/4 GHG4	3/4-14	3/4-14	1 3/8	1.87	4.0	
1 GHG4	1-11 1/2	1-11	1 5/8	2.17	3.0	

PTR34M

BSPT Reducing Adapter
BSPT / BSPP



TUBE FITTING PART #	END SIZE		C2 (mm)	L2 (mm)	Dynamic Pressure (x 1,000 PSI)		
	1 BSPT	2 BSPP			S	SS	B
1/4X1/8PTR34M	1/4-19	1/8-28	17	28	6.0	6.0	3.3
3/8X1/4PTR34M	3/8-19	1/4-19	19	33	6.0	6.0	3.3
1/2X1/4PTR34M	1/2-14	1/4-19	22	39	5.0	5.0	3.3
1/2X3/8PTR34M	1/2-14	3/8-19	22	39	5.0	5.0	3.3

Dimensions and pressures for reference only, subject to change.

TABLE OF CONTENTS

VISUAL INDEX

F

RI-ED

BSPP Reducing Adapter / Expander
BSPP / BSPP-ED
(for ISO 1179-1 / DIN 3852-2 Port)

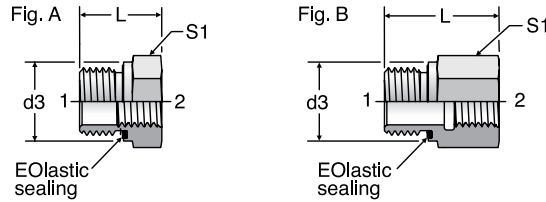


TABLE OF CONTENTS

VISUAL INDEX

TUBE FITTING PART #	END SIZE		d3 (mm)	L (mm)	S1 (mm)	Fig.	Dynamic Pressure (x 1,000 PSI)		
	1 BSPP	2 BSPP					CF	71	MS
RI1/8EDX1/4	1/8 - 28	1/4 - 19	14	31.0	19	B	5.8	5.8	3.3
RI1/8EDX3/8	1/8 - 28	3/8 - 19	14	32.0	24	B	5.8	5.8	3.3
RI1/4EDX1/8	1/4 - 19	1/8 - 28	19	29.0	19	B	5.8	5.8	3.3
RI1/4EDX3/8	1/4 - 19	3/8 - 19	19	36.0	24	B	5.8	5.8	3.3
RI1/4EDX1/2	1/4 - 19	1/2 - 14	19	40.0	30	B	5.8	5.8	3.3
RI1/4EDX3/4	1/4 - 19	3/4 - 14	19	43.0	36	B	5.8	5.8	3.3
RI3/8EDX1/8	3/8 - 19	1/8 - 28	22	22.5	22	A	5.8	5.8	3.3
RI3/8EDX1/4	3/8 - 19	1/4 - 19	22	36.0	22	B	5.8	5.8	3.3
RI3/8EDX1/2	3/8 - 19	1/2 - 14	22	41.0	30	B	5.8	5.8	3.3
RI3/8EDX3/4	3/8 - 19	3/4 - 14	22	44.0	36	B	4.5	4.5	3.0
RI1/2EDX1/8	1/2 - 14	1/8 - 28	27	24.0	27	A	5.8	5.8	3.3
RI1/2EDX1/4	1/2 - 14	1/4 - 19	27	24.0	27	A	5.8	5.8	3.3
RI1/2EDX3/8	1/2 - 14	3/8 - 19	27	37.0	27	B	5.8	5.8	3.3
RI1/2EDX3/4	1/2 - 14	3/4 - 14	27	46.0	36	B	4.5	4.5	3.0
RI1/2EDX1	1/2 - 14	1 - 11	27	49.0	41	B	4.5	4.5	3.0
RI1/2EDX11/4	1/2 - 14	1 1/4 - 11	27	53.0	55	B	4.5	4.5	3.0
RI3/4EDX1/4	3/4 - 14	1/4 - 19	32	26.0	32	A	4.5	4.5	3.0
RI3/4EDX3/8	3/4 - 14	3/8 - 19	32	26.0	32	A	4.5	4.5	3.0
RI3/4EDX1/2	3/4 - 14	1/2 - 14	32	43.0	32	B	4.5	4.5	3.0
RI3/4EDX1	3/4 - 14	1 - 11	32	51.0	41	B	4.5	4.5	3.0
RI3/4EDX11/4	3/4 - 14	1 1/4 - 11	32	55.0	55	B	4.5	4.5	3.0
RI3/4EDX11/2	3/4 - 14	1 1/2 - 11	32	57.0	60	B	3.6	3.6	2.3
RI1EDX1/4	1 - 11	1/4 - 19	40	29.0	41	A	4.5	4.5	3.0
RI1EDX3/8	1 - 11	3/8 - 19	40	29.0	41	A	4.5	4.5	3.0
RI1EDX1/2	1 - 11	1/2 - 14	40	29.0	41	A	4.5	4.5	3.0
RI1EDX3/4	1 - 11	3/4 - 14	40	49.0	41	B	4.5	4.5	3.0
RI1EDX11/4	1 - 11	1 1/4 - 11	40	57.0	55	B	4.5	4.5	3.0
RI1EDX11/2	1 - 11	1 1/2 - 11	40	59.0	60	B	3.6	3.6	2.3
RI11/4EDX1/2	1 1/4 - 11	1/2 - 14	50	32.0	50	A	4.5	4.5	3.0
RI11/4EDX3/4	1 1/4 - 11	3/4 - 14	50	32.0	50	A	4.5	4.5	3.0
RI11/4EDX1	1 1/4 - 11	1 - 11	50	53.0	50	B	4.5	4.5	3.0
RI11/4EDX11/2	1 1/4 - 11	1 1/2 - 11	50	60.0	60	B	3.6	3.6	2.3
RI11/2EDX1/2	1 1/2 - 11	1/2 - 14	55	36.0	55	A	3.6	3.6	2.3
RI11/2EDX3/4	1 1/2 - 11	3/4 - 14	55	36.0	55	A	3.6	3.6	2.3
RI11/2EDX1	1 1/2 - 11	1 - 11	55	36.0	55	A	3.6	3.6	2.3
RI11/2EDX11/4	1 1/2 - 11	1 1/4 - 11	55	58.0	55	B	3.6	3.6	2.3
RI2EDX11/2	2 - 11	1 1/2 - 11	72	65.0	75	B	2.3	2.3	1.5

Dimensions and pressures for reference only, subject to change.

RI

BSPP Reducing Adatper / Expander
BSPP / BSPP-CF
(for ISO 1179-1 / DIN 3852-2 Port)

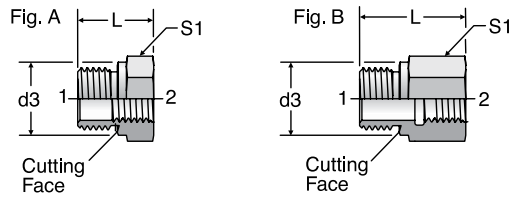


TABLE
OF
CONTENTS

VISUAL
INDEX

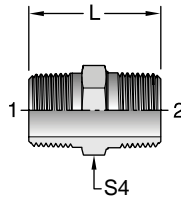
F

TUBE FITTING PART #	END SIZE		d3 (mm)	L (mm)	S1 (mm)	Fig.	Dynamic Pressure (x 1,000 PSI)		
	1 BSPP	2 BSPP					CF	71	MS
RI1/8X1/4	1/8 - 28	1/4 - 19	14	31.0	19	B	5.8	5.8	3.3
RI1/8X3/8	1/8 - 28	3/8 - 19	14	32.0	24	B	5.8	5.8	3.3
RI1/4X1/8	1/4 - 19	1/8 - 28	18	28.0	19	B	5.8	5.8	3.3
RI1/4X3/8	1/4 - 19	3/8 - 19	18	36.0	24	B	5.8	5.8	3.3
RI1/4X1/2	1/4 - 19	1/2 - 14	18	40.0	30	B	5.8	5.8	3.3
RI1/4X3/4	1/4 - 19	3/4 - 14	18	43.0	36	B	4.5	4.5	3.0
RI3/8X1/8	3/8 - 19	1/8 - 28	22	22.5	22	A	5.8	5.8	3.3
RI3/8X1/4	3/8 - 19	1/4 - 19	22	36.0	22	B	5.8	5.8	3.3
RI3/8X1/2	3/8 - 19	1/2 - 14	22	41.0	30	B	5.8	5.8	3.3
RI3/8X3/4	3/8 - 19	3/4 - 14	22	44.0	36	B	4.5	4.5	3.0
RI1/2X1/8	1/2 - 14	1/8 - 28	26	24.0	27	A	5.8	5.8	3.3
RI1/2X1/4	1/2 - 14	1/4 - 19	26	24.0	27	A	4.5	4.5	3.0
RI1/2X3/8	1/2 - 14	3/8 - 19	26	36.0	27	B	4.5	4.5	3.0
RI1/2X3/4	1/2 - 14	3/4 - 14	26	46.0	36	B	4.5	4.5	3.0
RI1/2X1	1/2 - 14	1 - 11	26	49.0	41	B	2.3	2.3	1.5
RI1/2X1 1/4	1/2 - 14	1 1/4 - 11	26	53.0	55	B	4.5	4.5	3.0
RI3/4X1/4	3/4 - 14	1/4 - 19	32	26.0	32	A	4.5	4.5	3.0
RI3/4X3/8	3/4 - 14	3/8 - 19	32	26.0	32	A	4.5	4.5	3.0
RI3/4X1/2	3/4 - 14	1/2 - 14	32	41.0	32	B	4.5	4.5	3.0
RI3/4X1	3/4 - 14	1 - 11	32	51.0	41	B	2.3	2.3	1.5
RI3/4X1 1/4	3/4 - 14	1 1/4 - 11	32	55.0	55	B	2.3	2.3	1.5
RI3/4X1 1/2	3/4 - 14	1 1/2 - 11	32	57.0	60	B	4.5	4.5	3.0
RI1X1/4	1 - 11	1/4 - 19	39	29.0	41	A	4.5	4.5	3.0
RI1X3/8	1 - 11	3/8 - 19	39	29.0	41	A	4.5	4.5	3.0
RI1X1/2	1 - 11	1/2 - 14	39	29.0	41	A	4.5	4.5	3.0
RI1X3/4	1 - 11	3/4 - 14	39	47.0	41	B	2.3	2.3	1.5
RI1X1 1/4	1 - 11	1 1/4 - 11	39	57.0	55	B	2.3	2.3	1.5
RI1X1 1/2	1 - 11	1 1/2 - 11	39	59.0	60	B	2.3	2.3	1.5
RI11/4X1/2	1 1/4 - 11	1/2 - 14	49	32.0	50	A	2.3	2.3	1.5
RI11/4X3/4	1 1/4 - 11	3/4 - 14	49	32.0	50	A	2.3	2.3	1.5
RI11/4X1	1 1/4 - 11	1 - 11	49	52.0	50	B	2.3	2.3	1.5
RI11/4X1 1/2	1 1/4 - 11	1 1/2 - 11	49	60.0	60	B	2.3	2.3	1.5
RI11/2X1/2	1 1/2 - 11	1/2 - 14	55	36.0	55	A	2.3	2.3	1.5
RI11/2X3/4	1 1/2 - 11	3/4 - 14	55	36.0	55	A	2.3	2.3	1.5
RI11/2X1	1 1/2 - 11	1 - 11	55	36.0	55	A	2.3	2.3	1.5
RI11/2X1 1/4	1 1/2 - 11	1 1/4 - 11	55	58.0	55	B	2.3	2.3	1.5
RI2X1 1/2	2 - 11	1 1/2 - 11	68	62.0	70	B	2.3	2.3	1.5

Dimensions and pressures for reference only, subject to change.

FHF3

Male Pipe Adapter
BSPT / NPTF

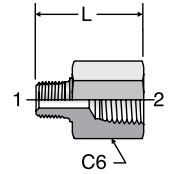


TUBE FITTING PART #	End Size		S4 Hex (in.)	L (in.)	Dynamic Pressure (x 1,000 PSI)		
	1 NPTF	2 BSPT			-S		
1/8 FHF3	1/8-27	1/8-28	7/16	1.09	6.0		
1/4 FHF3	1/4-18	1/4-19	5/8	1.45	6.0		
3/8 x 1/4 FHF3	3/8-18	1/4-19	3/4	1.45	6.0		
1/4 x 3/8 FHF3	1/4-18	1/8-28	3/4	1.45	6.0		
3/8 FHF3	3/8-18	3/8-19	3/4	1.45	6.0		
1/2 FHF3	1/2-14	1/2-14	7/8	1.89	6.0		
3/4 FHF3	3/4-14	3/4-14	1 1/8	1.96	5.5		
1 FHF3	1-11	1-11	1 3/8	2.34	4.5		

Note: The BSPT thread end has an identification collar.

F3HG

Conversion Adapter
NPTF / BSPT



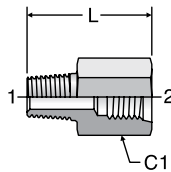
TUBE FITTING PART #	END SIZE		C6 HEX (in.)	L (mm)	Dynamic Pressure (x 1,000 PSI)		
	1 BSPT	2 NPTF			-S	-SS	-B
1/8 x 1/8F3HG	1/8 - 28	1/8 - 27	9/16	1.08	6.0	6.0	3.3
1/4 x 1/4F3HG	1/4 - 19	1/4 - 18	3/4	1.37	6.0	6.0	3.3
3/8 x 3/8F3HG	3/8 - 19	3/8 - 19	7/8	1.38	6.0	6.0	3.3
1/2 x 1/2F3HG	1/2 - 14	1/2 - 14	1 1/8	1.88	5.0	5.0	3.3
3/4 x 3/4F3HG	3/4 - 14	3/4 - 14	1 3/8	1.95	4.0	4.0	2.6
1 x 1F3HG	1 - 11	1 - 11	1 5/8	2.38	3.0	3.0	1.9
1 1/2 x 1 1/2F3HG	1 1/2 - 11	1 1/2 - 11	2 3/8	2.53	2.0	2.0	1.3

TABLE OF CONTENTS

VISUAL INDEX

F3HG5

Conversion Adapter
BSPT / SAE-ORB

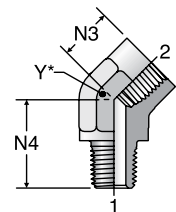


TUBE FITTING PART #	END SIZE		C1 HEX (in.)	L (in.)	Dynamic Pressure (x 1,000 PSI)		
	1 BSPT	2 UN/UNF-2B			-S	-SS	-B
1/8-4F3HG5	1/8 - 28	7/16 - 20	11/16	1.09	6.0	6.0	3.3
1/8-5F3HG5	1/8 - 28	1/2 - 20	3/4	1.09	6.0	6.0	3.3
1/4-6F3HG5	1/4 - 19	9/16 - 18	13/16	1.36	6.0	6.0	3.3
3/8-8F3HG5	3/8 - 19	3/4 - 16	1	1.45	5.0	5.0	3.3
1/2-10F3HG5	1/2 - 14	7/8 - 14	1 1/8	1.78	4.5	4.5	2.9
3/4-12F3HG5	3/4 - 14	1 1/16 - 12	1 3/8	1.92	4.5	4.5	2.9
1-16F3HG5	1 - 11	1 5/16 - 12	1 5/8	2.13	3.5	3.5	2.2

CD45

45° Pipe Elbow
NPTF / NPTF

SAE 140339
HPD Base # 3102



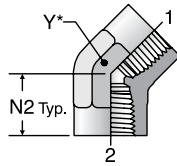
TUBE FITTING PART #	END SIZE		N3 (in.)	N4 (in.)	Y (in.)	Dynamic Pressure (x 1,000 PSI)		
	1 NPTF	2 NPTF				-S	-SS	-B
1/8 CD45	1/8 - 27	1/8 - 27	0.47	0.72	9/16	5.0	5.0	3.2
1/4 CD45	1/4 - 18	1/4 - 18	0.63	1.05	3/4	5.0	5.0	3.2
3/8 CD45	3/8 - 18	3/8 - 18	0.72	1.06	7/8	4.5	4.5	2.9
1/2 CD45	1/2 - 14	1/2 - 14	0.91	1.34	1 1/16	3.0	3.0	1.9
3/4 CD45	3/4 - 14	3/4 - 14	0.97	1.38	1 5/16	3.0	3.0	1.9
1 CD45	1 - 11 1/2	1 - 11 1/2	1.13	1.72	1 5/8	1.8	1.8	1.1
1 1/4 CD45	1 1/4 - 11 1/2	1 1/4 - 11 1/2	1.63	1.80	1 7/8	1.5	1.5	1.0

Dimensions and pressures for reference only, subject to change.

DD45

45° Female Pipe Elbow
NPTF / NPTF

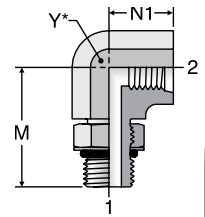
SAE 140338
HPD Base # 4202



AOEG5

Straight Thread Elbow
SAE-ORB / SAE-ORB

HPD Base # 2510



* Y – Across
Wrench Flats

TABLE
OF
CONTENTS

VISUAL
INDEX

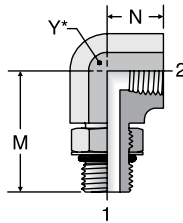
TUBE FITTING PART #	END SIZE		N2 (in.)	Y (in.)	Dynamic Pressure (x 1,000 PSI)		
	1	2			-S	-SS	-B
	NPTF	NPTF					
1/4 DD45	1/4 - 18	1/4 - 18	0.69	3/4	5.0	5.0	3.3
3/8 DD45	3/8 - 18	3/8 - 18	0.75	7/8	4.5	4.5	2.9
1/2 DD45	1/2 - 14	1/2 - 14	0.94	1 1/16	3.0	3.0	1.9
3/4 DD45	3/4 - 14	3/4 - 14	1.00	1 5/16	3.0	3.0	1.9
1 DD45	1 - 11 1/2	1 - 11 1/2	1.19	1 5/8	1.8	1.8	1.1

TUBE FITTING PART #	END SIZE		M (in.)	N1 (in.)	Y (in.)	Dynamic Pressure (x 1,000 PSI)		
	1	2				-S	-SS	-B
	UN/UNF-2A	UN/UNF-2B						
4 AOE5	7/16 - 20	7/16 - 20	1.23	0.63	3/4	6.0	6.0	3.3
6 AOE5	9/16 - 18	9/16 - 18	1.38	0.75	7/8	5.0	5.0	3.3
8 AOE5	3/4 - 16	3/4 - 16	1.59	0.88	1 1/16	4.0	4.0	2.6
10 AOE5	7/8 - 14	7/8 - 14	1.81	1.02	1 1/16	2.5	2.5	1.6
12 AOE5	1 1/16 - 12	1 1/16 - 12	2.00	1.21	1 5/16	2.5	2.5	1.6
16 AOE5	1 5/16 - 12	1 5/16 - 12	2.26	1.33	1 5/8	2.5	2.5	1.6

AOEG

Female Pipe Elbow
NPT / SAE-ORB

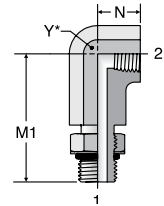
HPD Base # 2502



AOE4G

Extra Long Female Pipe Elbow
NPTF / SAE-ORB

HPD Base # 5502



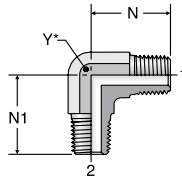
TUBE FITTING PART #	END SIZE		M (in.)	N (in.)	Y (in.)	Dynamic Pressure (x 1,000 PSI)		
	1	2				-S	-SS	-B
	UN/UNF-2A	NPTF						
6-1/4 AOE4G	9/16 - 18	1/4 - 18	1.34	0.63	3/4	5.0	5.0	3.3
8-3/8 AOE4G	3/4 - 16	3/8 - 18	1.47	0.63	7/8	4.5	4.5	2.9
10-1/2 AOE4G	7/8 - 14	1/2 - 14	1.81	0.75	1 1/16	3.0	3.0	1.9
12-3/4 AOE4G	1 1/16 - 12	3/4 - 14	2.00	0.81	1 5/16	3.0	3.0	1.9
16-1 AOE4G	1 5/16 - 12	1 - 11 1/2	2.25	1.00	1 5/8	1.8	1.8	1.1

TUBE FITTING PART #	END SIZE		M1 (in.)	N (in.)	Y (in.)	Dynamic Pressure (x 1,000 PSI)		
	1	2				-S	-SS	-B
	UN/UNF-2A	NPTF						
8-3/8 AOE4G	3/4 - 16	3/8 - 18	2.94	0.63	7/8	4.5	4.5	2.9
10-1/2 AOE4G	7/8 - 14	1/2 - 14	3.56	0.75	1 1/16	3.0	3.0	1.9
12-3/4 AOE4G	1 1/16 - 12	3/4 - 14	4.06	0.81	1 5/16	3.0	3.0	1.9
16-1 AOE4G	1 5/16 - 12	1 - 11 1/2	4.63	1.00	1 5/8	1.8	1.8	1.1

Dimensions and pressures for reference only, subject to change.

CR
Male Pipe Elbow
NPTF / NPTF

SAE 140237*



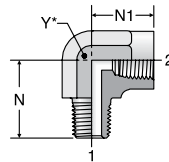
* Y – Across
Wrench Flats

TUBE FITTING PART #	END SIZE		N (in.)	N1 (in.)	Y (in.)	Dynamic Pressure (x 1,000 PSI)		
	1 NPTF	2 NPTF				-S	-SS	-B
	1/8 CR	1/8 - 27						
1/4 CR	1/4 - 18	1/4 - 18	1.09	1.09	9/16	6.0	6.0	3.9
3/8 CR	3/8 - 18	3/8 - 18	1.22	1.22	3/4	6.0	6.0	3.9
3/8 x 1/4 CR	3/8 - 18	1/4 - 18	1.22	1.22	3/4	6.0	6.0	3.3
1/2 CR	1/2 - 14	1/2 - 14	1.47	1.47	7/8	6.0	6.0	3.9
1/2 x 3/8 CR	1/2 - 14	3/8 - 18	1.47	1.28	7/8	6.0	6.0	3.3
3/4 CR	3/4 - 14	3/4 - 14	1.59	1.59	1 1/16	4.0	4.0	2.6
3/4 x 1/2 CR	3/4 - 14	1/2 - 14	1.59	1.47	1 1/16	4.0	4.0	2.6
1 CR	1 - 11 1/2	1 - 11 1/2	1.97	1.97	1 5/16	3.0	3.0	1.9
1 x 3/4 CR	1 - 11 1/2	3/4 - 14	1.97	1.78	1 5/16	3.0	3.0	1.9
1 1/4 CR	1 1/4 - 11 1/2	1 1/4 - 11 1/2	2.22	2.22	1 7/8	2.5	2.5	1.6
1 1/2 CR	1 1/2 - 11 1/2	1 1/2 - 11 1/2	2.34	2.34	1 7/8	2.5	2.5	1.6

* Not shown in SAE J514, but coded per SAE J846.

CD
Street Elbow
NPTF / NPT

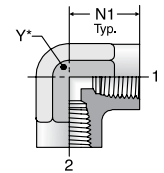
SAE 140239
HPD Base # 2102



TUBE FITTING PART #	END SIZE		N (in.)	N1 (in.)	Y (in.)	Dynamic Pressure (x 1,000 PSI)		
	1 NPTF	2 NPT				-S	-SS	-B
	1/8 CD	1/8 - 27						
1/8 x 1/4 CD	1/8 - 27	1/4 - 18	0.90	0.88	3/4	5.0	5.0	3.2
1/4 CD	1/4 - 18	1/4 - 18	1.09	0.88	3/4	5.0	5.0	3.2
1/4 x 1/8 CD	1/4 - 18	1/8 - 27	1.09	0.66	9/16	5.0	5.0	3.2
1/4 x 1/2 CD	1/4 - 18	1/2 - 14	1.28	1.23	1 1/16	3.0	3.0	1.9
1/4 x 3/8 CD	1/4 - 18	3/8 - 18	1.22	1.01	7/8	4.5	4.5	2.9
3/8 CD	3/8 - 18	3/8 - 18	1.22	1.02	7/8	4.5	4.5	3.0
3/8 x 1/4 CD	3/8 - 18	1/4 - 18	1.22	0.88	3/4	5.0	5.0	3.2
3/8 x 1/2 CD	3/8 - 18	1/2 - 14	1.28	1.23	1 1/16	3.0	3.0	1.9
1/2 CD	1/2 - 14	1/2 - 14	1.47	1.23	1 1/16	3.0	3.0	1.9
1/2 x 3/8 CD	1/2 - 14	3/8 - 18	1.48	1.25	7/8	4.5	4.5	2.9
1/2 x 3/4 CD	1/2 - 14	3/4 - 14	1.58	1.36	1 5/16	3.0	3.0	1.9
3/4 CD	3/4 - 14	3/4 - 14	1.59	1.36	1 5/16	3.0	3.0	1.9
3/4 x 1/2 CD	3/4 - 14	1/2 - 14	1.59	1.23	1 1/16	3.0	3.0	1.9
1 CD	1 - 11 1/2	1 - 11 1/2	1.97	1.63	1 5/8	1.8	1.8	1.2
1 1/4 CD	1 1/4 - 11 1/2	1 1/4 - 11 1/2	2.38	1.70	1 7/8	1.5	1.5	1.0
1 1/4 x 1 1/2 CD	1 1/4 - 11 1/2	1 1/2 - 11 1/2	2.61	2.08	2 1/2	1.5	1.5	1.0
1 1/2 CD	1 1/2 - 11 1/2	1 1/2 - 11 1/2	2.64	2.08	2 1/2	1.5	1.5	1.0

DD
Female Pipe Elbow
NPT / NPT

SAE 140238
HPD Base # 2202



TUBE FITTING PART #	END SIZE		N1 (in.)	Y (in.)	Dynamic Pressure (x 1,000 PSI)		
	1 NPT	2 NPT			-S	-SS	-B
	1/8 DD	1/8 - 27					
1/4 DD	1/4 - 18	1/4 - 18	0.88	3/4	5.0	5.0	3.2
3/8 DD	3/8 - 18	3/8 - 18	1.02	7/8	4.5	4.5	3.0
1/2 DD	1/2 - 14	1/2 - 14	1.23	1 1/16	3.0	3.0	1.9
1/2 x 3/8 DD	1/2 - 14	3/8 - 18	1.23	1 1/16	3.0	3.0	1.9
3/4 DD	3/4 - 14	3/4 - 14	1.36	1 5/8	3.0	3.0	1.9
1 DD	1 - 11 1/2	1 - 11 1/2	1.63	1 7/8	1.8	1.8	1.2
1 1/4 DD	1 1/4 - 11 1/2	1 1/4 - 11 1/2	1.70	1 7/8	1.5	1.5	1.5
1 1/2 DD	1 1/2 - 11 1/2	1 1/2 - 11 1/2	2.08	2 1/2	1.5	1.5	1.5

Dimensions and pressures for reference only, subject to change.

A87LPOEG87LPM

ISO 6149* Female Elbow
 SHORT ISO 6149 / SHORT ISO 6149

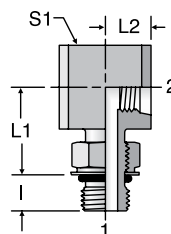


TABLE
 OF
 CONTENTS

VISUAL
 INDEX

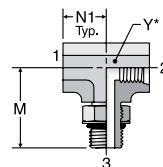
TUBE FITTING PART #	END SIZE		I (mm)	L1 (mm)	L2 (mm)	S1 (mm)	Dynamic Pressure (x 1,000 PSI)		
	1	2					S	SS	B
	Metric	Metric							
M08A87LPOEG87LPM	M8X1	M8X1	8.5	13.5	7.5	15	4.0	4.0	2.6
M10A87LPOEG87LPM	M10X1	M10X1	8.5	14.5	7.5	15	4.0	4.0	2.6
M12A87LPOEG87LPM	M12X1.5	M12X1.5	11.0	17.0	10.0	20	3.6	3.6	2.3
M14A87LPOEG87LPM	M14X1.5	M14X1.5	11.0	18.0	10.0	20	3.6	3.6	2.3

* Male and female thread lengths have been shortened for compact design. The lengths do not conform to ISO 6149.

F

G5G5JAO

Straight Thread Branch Tee
 SAE-ORB (all three ends)



* Y – Across
 Wrench Flats

TUBE FITTING PART #	END SIZE			M (in.)	N1 (in.)	Y (in.)	Dynamic Pressure (x 1,000 PSI)		
	1	2	3				-S	-SS	-B
	UN/UNF-2B	UN/UNF-2B	UN/UNF-2A						
4 G5G5JAO	7/16 - 20	7/16 - 20	7/16 - 20	1.23	0.63	3/4	6.0	6.0	3.3
6 G5G5JAO	9/16 - 18	9/16 - 18	9/16 - 18	1.38	0.75	7/8	5.0	5.0	3.3
8 G5G5JAO	3/4 - 16	3/4 - 16	3/4 - 16	1.59	0.88	1 1/16	4.0	4.0	2.6
10 G5G5JAO	7/8 - 14	7/8 - 14	7/8 - 14	1.81	1.02	1 1/16	2.5	2.5	1.6
12 G5G5JAO	1 1/16 - 12	1 1/16 - 12	1 1/16 - 12	2.00	1.21	1 5/16	2.5	2.5	1.6
16 G5G5JAO	1 5/16 - 12	1 5/16 - 12	1 5/16 - 12	2.25	1.33	1 5/8	2.5	2.5	1.6

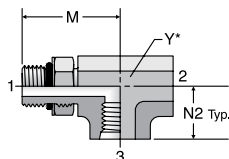
Dimensions and pressures for reference only, subject to change.

TABLE
OF
CONTENTS

VISUAL
INDEX

AOG5JG5

Straight Thread Run Tee
SAE-ORB (all three ends)

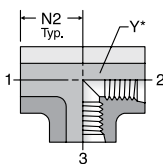


* Y – Across Wrench Flats

TUBE FITTING PART #	END SIZE			M (in.)	N2 (in.)	Y (in.)	Dynamic Pressure (x 1,000 PSI)		
	1 UN/UNF-2A	2 UN/UNF-2B	3 UN/UNF-2B				-S	-SS	-B
	4 AOG5JG5	7/16 - 20	7/16 - 20						
6 AOG5JG5	9/16 - 18	9/16 - 18	9/16 - 18	1.38	0.86	7/8	5.0	5.0	3.3
8 AOG5JG5	3/4 - 16	3/4 - 16	3/4 - 16	1.59	1.03	1 1/16	4.0	4.0	2.6
10 AOG5JG5	7/8 - 14	7/8 - 14	7/8 - 14	1.81	1.18	1 1/16	2.5	2.5	1.6
12 AOG5JG5	1 1/16 - 12	1 1/16 - 12	1 1/16 - 12	2.00	1.39	1 5/16	2.5	2.5	1.6
16 AOG5JG5	1 5/16 - 12	1 5/16 - 12	1 5/16 - 12	2.25	1.52	1 5/8	2.5	2.5	1.6

G5G5JG5

Female Straight Thread Tee
SAE-ORB (all three ends)

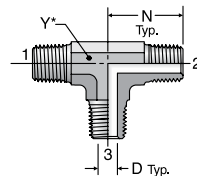


* Y – Across Wrench Flats

TUBE FITTING PART #	END SIZE			Dynamic Pressure (x 1,000 PSI)		
	1-3 UN/UNF-2B	N2 (in.)	Y (in.)	-S	-SS	-B
	4 G5G5JG5	7/16 - 20	0.74			
6 G5G5JG5	9/16 - 18	0.86	7/8	5.0	5.0	3.3
8 G5G5JG5	3/4 - 16	1.03	1 1/16	4.0	4.0	2.6
10 G5G5JG5	7/8 - 14	1.18	1 1/16	2.5	2.5	1.6
12 G5G5JG5	1 1/16 - 12	1.39	1 5/16	2.5	2.5	1.6
16 G5G5JG5	1 5/16 - 12	1.52	1 5/8	2.5	2.5	1.6

RRS

Male Pipe Tee
NPTF (all three ends)

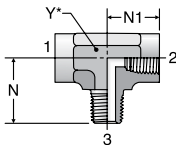


SAE 140437

TUBE FITTING PART #	END SIZE			Dynamic Pressure (x 1,000 PSI)		
	1-3 NPTF	N (in.)	Y (in.)	-S	-SS	-B
	1/8 RRS	1/8 - 27	0.78			
1/4 RRS	1/4 - 18	1.09	9/16	6.0	6.0	3.9
3/8 RRS	3/8 - 18	1.22	3/4	6.0	6.0	3.9
1/2 RRS	1/2 - 14	1.47	7/8	6.0	6.0	3.9
3/4 RRS	3/4 - 14	1.59	1 1/16	4.0	4.0	2.6

MMS

Male Branch Tee
NPTF (all three ends)

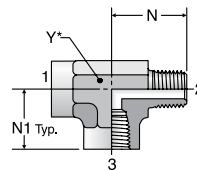


SAE 140425
HPD Base # 212T

TUBE FITTING PART #	END SIZE				Dynamic Pressure (x 1,000 PSI)		
	1-3 NPTF	N (in.)	N1 (in.)	Y (in.)	-S	-SS	-B
	1/8 MMS	1/8 - 27	0.78	0.66			
1/4 MMS	1/4 - 18	1.09	0.88	3/4	5.0	5.0	3.2
3/8 MMS	3/8 - 18	1.22	1.02	7/8	4.5	4.5	3.0
1/2 MMS	1/2 - 14	1.47	1.23	1 1/16	3.0	3.0	1.9
3/4 MMS	3/4 - 14	1.59	1.36	1 5/16	3.0	3.0	1.9
1 MMS	1 - 11 1/2	1.97	1.62	1 5/8	1.8	1.8	1.1

MRO

Male Run Tee
NPTF (all three ends)



SAE 140424
HPD Base # 012T

TUBE FITTING PART #	END SIZE				Dynamic Pressure (x 1,000 PSI)		
	1-3 NPTF	N (in.)	N1 (in.)	Y (in.)	-S	-SS	-B
	1/8 MRO	1/8 - 27	0.78	0.66			
1/4 MRO	1/4 - 18	1.09	0.88	3/4	5.0	5.0	3.2
3/8 MRO	3/8 - 18	1.22	1.02	7/8	4.5	4.5	3.0
1/2 MRO	1/2 - 14	1.47	1.23	1 1/16	3.0	3.0	1.9
3/4 MRO	3/4 - 14	1.59	1.36	1 5/16	3.0	3.0	1.9
1 MRO	1 - 11 1/2	1.97	1.63	1 5/8	1.8	1.8	1.1
1 1/4 MRO	1 1/4 - 11 1/2	2.38	1.70	1 7/8	1.5	1.5	1.0
1 1/2 MRO	1 1/2 - 11 1/2	2.64	2.08	2 1/2	1.5	1.5	1.0

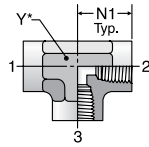
Dimensions and pressures for reference only, subject to change.



MMO

Female Pipe Tee
NPTF (all three ends)

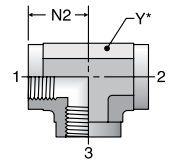
SAE 140438
HPD Base # 022T



TUBE FITTING PART #	END SIZE	N1 (in.)	Y (in.)	Dynamic Pressure (x 1,000 PSI)		
				1-3 NPTF		
	-S			-SS	-B	
1/8 MMO	1/8 - 27	0.66	9/16	5.0	5.0	3.2
1/4 MMO	1/4 - 18	0.88	3/4	5.0	5.0	3.2
3/8 MMO	3/8 - 18	1.02	7/8	4.5	4.5	3.0
1/2 MMO	1/2 - 14	1.23	1 1/16	3.0	3.0	1.9
3/4 MMO	3/4 - 14	1.36	1 5/16	3.0	3.0	1.9
1 MMO	1 - 11 1/2	1.63	1 5/8	1.8	1.8	1.2
1 1/4 MMO	1 1/4 - 11 1/2	1.70	1 7/8	1.5	1.5	1.0
1 1/2 MMO	1 1/2 - 11 1/2	2.08	2 1/2	1.5	1.5	1.0

MMO444M

Female BSPP Tee
BSPP (all three ends)



TUBE FITTING PART #	END SIZE	N2 (mm)	Y (mm)	Dynamic Pressure (x 1,000 PSI)		
				1-3 BSPP		
	S			SS	B	
1/4MMO444M	1/4 - 19	22	19	5.0	5.0	3.3
3/8MMO444M	3/8 - 19	26	22	4.5	4.5	2.9
1/2MMO444M	1/2 - 14	31	27	3.0	3.0	1.9
3/4MMO444M	3/4 - 14	40	33	3.0	3.0	1.9
1MMO444M	1 - 11	46	41	1.8	1.8	1.1

TABLE OF CONTENTS

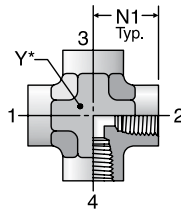
VISUAL INDEX

F

KMMOO

Female Pipe Cross
NPTF (all four ends)

SAE 140538
HPD Base # 022X

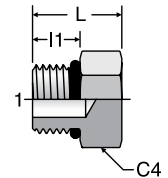


TUBE FITTING PART #	END SIZE	N1 (in.)	Y (in.)	Dynamic Pressure (x 1,000 PSI)		
				1-4 NPTF		
	-S			-SS	-B	
1/8 KMMOO	1/8 - 27	0.66	9/16	5.0	5.0	3.2
1/4 KMMOO	1/4 - 18	0.88	3/4	5.0	5.0	3.2
3/8 KMMOO	3/8 - 18	1.02	7/8	4.5	4.5	2.9
1/2 KMMOO	1/2 - 14	1.23	1 1/16	3.0	3.0	1.9
3/4 KMMOO	3/4 - 14	1.36	1 5/16	3.0	3.0	1.9
1 KMMOO	1 - 11 1/2	1.63	1 5/8	1.8	1.8	1.1

P50N

Hex Head Plug
SAE-ORB

SAE 090109A
HPD Base # 05CP



TUBE FITTING PART #	END SIZE	C4 HEX (in.)	I1 (in.)	L (in.)	Dynamic Pressure (x 1,000 PSI)		
					1 UN/UNF-2A		
	-S				-SS	-B	
2 P50N	5/16 - 24	7/16	0.30	0.60	7.5	9.0	3.3
3 P50N	3/8 - 24	1/2	0.30	0.60	7.5	9.0	3.3
4 P50N	7/16 - 20	9/16	0.36	0.67	7.5	9.0	3.3
5 P50N	1/2 - 20	5/8	0.36	0.67	6.0	7.2	3.3
6 P50N	9/16 - 18	11/16	0.39	0.73	6.0	7.2	3.3
8 P50N	3/4 - 16	7/8	0.44	0.80	6.0	7.2	3.3
10 P50N	7/8 - 14	1	0.50	0.94	6.0	7.2	3.3
12 P50N	1 1/16 - 12	1 1/4	0.59	1.09	6.0	7.2	3.3
14 P50N	1 3/16 - 12	1 3/8	0.59	1.09	5.5	6.6	3.3
16 P50N	1 5/16 - 12	1 1/2	0.59	1.13	5.5	6.6	3.3
20 P50N	1 5/8 - 12	1 7/8	0.59	1.20	4.0	4.8	2.6
24 P50N	1 7/8 - 12	2 1/8	0.59	1.27	3.0	3.6	1.9
32 P50N	2 1/2 - 12	2 3/4	0.59	1.44	2.0	2.4	1.3

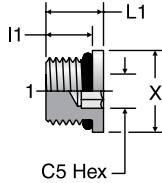
Dimensions and pressures for reference only, subject to change.



HP50N

Hollow Hex Plug
SAE-ORB

SAE 090109B
HPD Base # 05HP

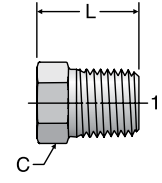


TUBE FITTING PART #	END SIZE 1 UN/UNF-2A	C5 HEX (in.)	I1 (in.)	L1 (in.)	X DIA (in.)	Dynamic Pressure (x 1,000 PSI)		
						-S	-SS	-B
2 HP50N	5/16 - 24	1/8	0.30	0.40	0.44	6.0	6.0	3.3
3 HP50N	3/8 - 24	5/32	0.30	0.40	0.50	6.0	6.0	3.3
4 HP50N	7/16 - 20	3/16	0.36	0.47	0.56	6.0	6.0	3.3
5 HP50N	1/2 - 20	7/32	0.36	0.47	0.63	6.0	6.0	3.3
6 HP50N	9/16 - 18	1/4	0.40	0.50	0.69	6.0	6.0	3.3
8 HP50N	3/4 - 16	5/16	0.44	0.58	0.88	6.0	6.0	3.3
10 HP50N	7/8 - 14	3/8	0.50	0.65	1.00	6.0	6.0	3.3
12 HP50N	1 1/16 - 12	9/16	0.59	0.77	1.25	6.0	6.0	3.3
14 HP50N	1 3/16 - 12	9/16	0.59	0.77	1.38	5.5	5.5	3.3
16 HP50N	1 5/16 - 12	5/8	0.59	0.77	1.50	5.5	5.5	3.3
20 HP50N	1 5/8 - 12	3/4	0.59	0.77	1.88	4.0	4.0	2.6
24 HP50N	1 7/8 - 12	3/4	0.59	0.77	2.13	3.0	3.0	1.9

HP

Hex Head Pipe Plug
NPTF

SAE 130109E
HPD Base # 01CP

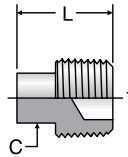


TUBE FITTING PART #	END SIZE 1 NPTF	C HEX (in.)	L (in.)	Dynamic Pressure (x 1,000 PSI)		
				-S	-SS	-B
1/8 HP	1/8 - 27	7/16	0.56	6.0	7.2	3.9
1/4 HP	1/4 - 18	9/16	0.75	6.0	7.2	3.9
3/8 HP	3/8 - 18	11/16	0.78	6.0	7.2	3.9
1/2 HP	1/2 - 14	7/8	0.97	6.0	7.2	3.9
3/4 HP	3/4 - 14	1 1/16	1.06	5.5	6.6	3.5
1 HP*	1 - 11 1/2	1 5/16	1.25	4.5	5.4	3.0
1 1/4 HP	1 1/4 - 11 1/2	1 3/4	1.41	3.0	3.6	1.9
1 1/2 HP	1 1/2 - 11 1/2	2	1.50	3.0	3.6	1.9
2 HP	2 - 11 1/2	2 1/2	1.69	2.0	3.0	1.3

* 1 HP-SS Hex is 1 3/8

SHP

Square Head Plug
NPTF

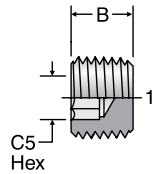


TUBE FITTING PART #	END SIZE 1 NPTF	C SQUARE (in.)	L (in.)	Dynamic Pressure (x 1,000 PSI)		
				-S	-SS	-B
1/8 SHP	1/8 - 27	9/32	0.51	6.0	7.2	3.3
1/4 SHP	1/4 - 18	3/8	0.75	6.0	6.0	3.3
3/8 SHP	3/8 - 18	7/16	0.83	6.0	6.0	3.3
1/2 SHP	1/2 - 14	9/16	1.08	6.0	6.0	3.3
3/4 SHP	3/4 - 14	5/8	1.14	6.0	6.0	3.3
1 SHP	1 - 11 1/2	13/16	1.38	5.5	5.5	3.3

HHP

Hollow Hex Pipe Plug
NPTF

SAE 130109N
HPD Base # 01HP



TUBE FITTING PART #	END SIZE 1 NPTF	B (in.)	C5 INTERNAL HEX (in.)	Dynamic Pressure (x 1,000 PSI)		
				-S	-SS	-B
1/16 HHP	1/16 - 27	0.30	5/32	6.0	7.2	3.3
1/8 HHP	1/8 - 27	0.30	3/16	6.0	7.2	3.9
1/4 HHP	1/4 - 18	0.46	1/4	6.0	7.2	3.9
3/8 HHP	3/8 - 18	0.46	5/16	6.0	7.2	3.3
1/2 HHP	1/2 - 14	0.61	3/8	6.0	7.2	3.3
3/4 HHP	3/4 - 14	0.62	9/16	5.5	6.6	3.3
1 HHP	1 - 11 1/2	0.77	3/4	4.5	5.4	3.3
1 1/4 HHP	1 1/4 - 11 1/2	0.77	3/4	3.0	5.0	3.3
1 1/2 HHP	1 1/2 - 11 1/2	0.83	3/4	3.0	3.0	1.9
2 HHP	2 - 11 1/2	0.86	3/4	2.0	2.5	1.6

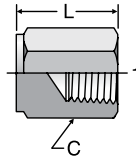
Dimensions and pressures for reference only, subject to change.

TABLE OF CONTENTS

VISUAL INDEX

HPC

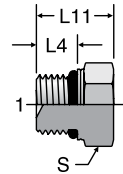
Hex Pipe Cap
NPTF



TUBE FITTING PART #	END SIZE 1 NPTF	C HEX (in.)	L (in.)	Dynamic Pressure (x 1,000 PSI)		
				-S	-SS	-B
	1/8 HPC	1/8 - 27	9/16	.75	6.0	6.0
1/4 HPC	1/4 - 18	3/4	.91	6.0	6.0	3.3
3/8 HPC	3/8 - 18	7/8	1.03	6.0	6.0	3.3
1/2 HPC	1/2 - 14	1 1/16	1.34	6.0	6.0	3.3
3/4 HPC	3/4 - 14	1 1/4	1.44	4.8	4.8	3.1
1 HPC	1 - 11 1/2	1 5/8	1.68	3.6	3.6	2.3
1 1/2 HPC	1 1/2 - 1 1/2	2 3/8	1.92	2.4	2.4	1.5

P87OMN

ISO 6149 Hex Head Plug
ISO 6149
(for ISO 6149-1 Port)



SAE J2244-4* 62M0109A

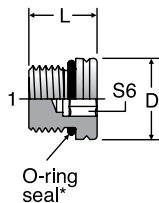
TUBE FITTING PART #	END SIZE 1 THREAD	L4 (mm)	L11 (mm)	S HEX (mm)	Dynamic Pressure (x 1,000 PSI)		
					S	SS	B
	M8P87OMN	M8X1	8.5	16.2	12	9.0	9.0
M10P87OMN	M10X1	8.5	16.2	14	8.0	8.0	3.3
M12P87OMN	M12X1.5	11.0	18.5	17	9.0	9.0	3.3
M14P87OMN	M14X1.5	11.0	19.5	19	9.0	9.0	3.3
M16P87OMN	M16X1.5	11.5	21.5	22	9.0	9.0	3.3
M18P87OMN	M18X1.5	12.5	23.5	24	9.0	9.0	3.3
M20P87OMN	M20X1.5	12.5	24.0	27	6.0	6.0	3.3
M22P87OMN	M22X1.5	13.0	25.5	27	6.0	6.0	3.3
M27P87OMN	M27X2	16.0	32.0	32	6.0	6.0	3.3
M30P87OMN	M30X2	16.0	32.0	36	6.0	6.0	3.3
M33P87OMN	M33X2	16.0	32.0	41	6.0	6.0	3.3
M42P87OMN	M42X2	16.0	34.0	50	4.0	4.0	2.6
M48P87OMN	M48X2	17.5	35.5	55	2.0	2.0	1.3
M60P87OMN	M60X2	17.5	42.0	65	1.0	1.0	0.6

* SAE J2244-4 and ISO 6149-4 are draft standards.

VSTI M-OR

ISO 6149 Hollow Hex Plug
ISO 6149
(for ISO 6149-1 Port)

SAE J2244-4* 62M0109B

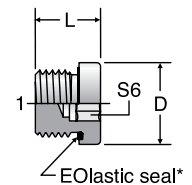


TUBE FITTING PART #	END SIZE 1 METRIC	D (mm)	L (mm)	S6 (mm)	Dynamic Pressure (x 1,000 PSI)		
					CF	71	MS
	VSTI10X1OR	M10 x 1	13	13.5	5	9.1	9.1
VSTI12X1.5OR	M12 x 1.5	17	15.1	6	9.1	9.1	3.3
VSTI14X1.5OR	M14 x 1.5	19	16.0	6	9.1	9.1	3.3
VSTI16X1.5OR	M16 x 1.5	21	17.5	8	9.1	9.1	3.3
VSTI18X1.5OR	M18 x 1.5	23	19.0	8	9.1	9.1	3.3
VSTI22X1.5OR	M22 x 1.5	27	20.0	10	9.1	9.1	3.3
VSTI27X2OR	M27 x 2	32	23.5	12	5.8	5.8	3.3
VSTI33X2OR	M33 x 2	38	25.0	14	5.8	5.8	3.3
VSTI42X2OR	M42 x 2	48	25.5	22	5.8	5.8	3.3

* SAE J2244-4 is a draft standard

VSTI M-ED

Metric Hollow Hex Plug
Metric-ED
(for ISO 9974-1 / DIN 3852-1 Port)

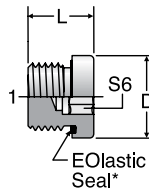


TUBE FITTING PART #	END SIZE 1 THREAD	D (mm)	L (mm)	S6 (mm)	Dynamic Pressure (x 1,000 PSI)		
					CF	71	MS
	VSTI10X1ED	M10 x 1	14	12.0	5	5.8	5.8
VSTI12X1.5ED	M12 x 1.5	17	17.0	6	5.8	5.8	3.3
VSTI14X1.5ED	M14 x 1.5	19	17.0	6	5.8	5.8	3.3
VSTI16X1.5ED	M16 x 1.5	22	17.0	8	5.8	5.8	3.3
VSTI18X1.5ED	M18 x 1.5	24	17.0	8	5.8	5.8	3.3
VSTI20X1.5ED	M20 x 1.5	26	19.0	10	5.8	5.8	3.3
VSTI22X1.5ED	M22 x 1.5	27	19.0	10	5.8	5.8	3.3
VSTI26X1.5ED	M26 x 1.5	32	21.0	12	5.8	5.8	3.3
VSTI27X2ED	M27 x 2	32	21	12	5.8	5.8	3.3
VSTI33X2ED	M33 x 2	40	22.5	17	5.8	5.8	3.3
VSTI42X2ED	M42 x 2	50	22.5	22	4.5	4.5	2.9
VSTI48X2ED	M48 x 2	55	22.5	24	4.5	4.5	2.9

Dimensions and pressures for reference only, subject to change.

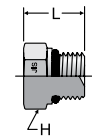
VSTI R-ED

BSPP Hollow Hex Plug
BSPP-ED
(for ISO 1179-1 / DIN 3852-2 Port)



P470MN

Hex Head Plug
BSPP-ORB

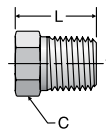


TUBE FITTING PART #	END SIZE	D (mm)	L (mm)	S6 (mm)	Dynamic Pressure (x 1,000 PSI)		
					CF	71	MS
	1 BSPP						
VSTI1/8ED	1/8 - 28	14	12.0	5	5.8	5.8	3.3
VSTI1/4ED	1/4 - 19	19	17.0	6	5.8	5.8	3.3
VSTI3/8ED	3/8 - 19	22	17.0	8	5.8	5.8	3.3
VSTI1/2ED	1/2 - 14	27	19.0	10	5.8	5.8	3.3
VSTI3/4ED	3/4 - 14	32	21.0	12	5.8	5.8	3.3
VSTI1ED	1 - 11	40	22.5	17	5.8	5.8	3.3
VSTI1 1/4ED	1 1/4 - 11	50	22.5	22	4.5	4.5	2.9
VSTI1 1/2ED	1 1/2 - 11	55	22.5	24	4.5	4.5	2.9

TUBE FITTING PART #	END SIZE	H HEX (mm)	L (mm)	Dynamic Pressure (x 1,000 PSI)		
				S	SS	B
	1 BSPP					
4P470MNS	1/4-19	19	19.1	5.0		
6P470MNS	3/8-19	22	20.0	5.0		
8P470MNS	1/2-14	27	24.1	5.0		
12P470MNS	3/4-14	36	26.9	4.0		
16P470MNS	1-11	41	31.0	3.0		

HP3M

Hex Head Pipe Plug
BSPT



TUBE FITTING PART #	END SIZE	C HEX (mm)	L (mm)	Dynamic Pressure (x 1,000 PSI)		
				S	SS	B
	1 BSPT					
1/8HP3M	1/8 - 28	10	14.2	6.0	6.0	3.3
1/4HP3M	1/4 - 19	14	19.1	6.0	6.0	3.3
3/8HP3M	3/8 - 19	17	19.8	6.0	6.0	3.3
1/2HP3M	1/2 - 14	22	24.6	6.0	6.0	3.3
3/4HP3M	3/4 - 14	27	26.9	5.5	5.5	3.3
1HP3M	1 - 11	36	31.8	4.5	4.5	2.9

TABLE OF CONTENTS

VISUAL INDEX

Dimensions and pressures for reference only, subject to change.



TABLE
OF
CONTENTS

VISUAL
INDEX


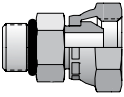
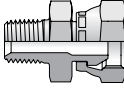
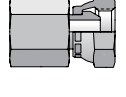
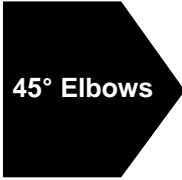
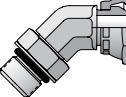
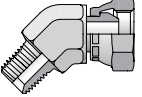
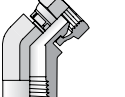

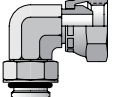
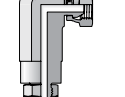
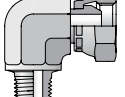
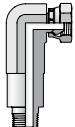
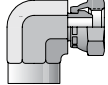
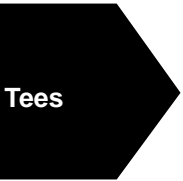
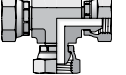
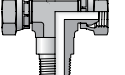
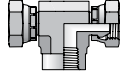
Pipe Swivels

G



ENGINEERING YOUR SUCCESS.

**TABLE
 OF
 CONTENTS**

<p>Straights</p> 	<p>0507 SAE-ORB / NPSM Swivel</p>  <p>G5</p>	<p>0107 NPTF / NPSM Swivel</p>  <p>G5</p>	<p>0207 NPTF / NPSM Swivel</p>  <p>G5</p>	<p>45° Elbows</p> 	<p>3507 SAE-ORB / NPSM Swivel</p>  <p>G5</p>
<p>3107 NPTF / NPSM Swivel</p>  <p>G6</p>	<p>3207 NPTF / NPSM Swivel</p>  <p>G6</p>	<p>90° Elbows</p> 	<p>2507 SAE-ORB / NPSM Swivel</p>  <p>G6</p>	<p>5507 SAE-ORB / NPSM Swivel</p>  <p>G6</p>	<p>2107 NPTF / NPSM Swivel</p>  <p>G7</p>
<p>5607 NPTF / NPSM Swivel Long Drop</p>  <p>G7</p>	<p>2207 NPTF / NPSM Swivel</p>  <p>G7</p>	<p>Tees</p> 	<p>077T NPSM Swivel / NPSM Swivel / NPSM Swivel</p>  <p>G7</p>	<p>217T NPSM Swivel / NPSM Swivel / NPTF</p>  <p>G8</p>	<p>227T NPSM Swivel / NPSM Swivel / NPTF</p>  <p>G8</p>

Pipe Swivels

Pipe swivel connections are one of the most traditional types of hydraulic connections. NPSM swivel adapters add versatility to male NPT hose and adapter connections. They are especially suited for manufacturers and end users that rely on this versatility. As a result, equipment manufacturers can simplify their hose assembly requirements by specifying NPSM adapters. See Fig. G1 for an illustration of this product flexibility.

Parker offers a full line of NPSM pipe swivel adapters. Fourteen configurations are available as standard, many of which are available in steel and stainless steel. Parker's pipe swivels are designed for use with male NPT/NPTF hose fittings and adapters with a 30° machined seat.

How Pipe Swivel Fittings Work

Pipe swivel adapters are manufactured in accordance to SAE J514 specifications, and thus are designed to work in conjunction with several manufacturers' hose and adapter products. Unlike most pipe thread connections, NPSM swivel adapters do not seal on the threads. NPSM swivel connections incorporate parallel threads, as opposed to tapered. Sealing is accomplished between the nose of the swivel and the mating seat of the NPT pipe thread. This creates a metal-to-metal seal as shown in Fig. G2. Thus, a mating NPT male connector must have this 30° seat to ensure proper sealing. A full internal 30° seat with surface finish requirements of 125 Ra or better is required. See SAE J516 for specific requirements of the 30° seat.

Not all male NPT ends have the 30° seat. Parts that have this seat will include a note in the catalog.

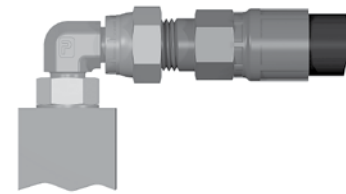
Threads:

NPTF:	ANSI B1.20.1, FED-STD-H28/7
NPT:	SAEJ476, ANSI B1.20.3, FED-STD-H28/8
NPSM:	ANSI B1.20.1, FED-STD-H28/7
*UN/UNF:	ANSI B1.1, FED-STD-H28/2 (*Class 2A or 2B)

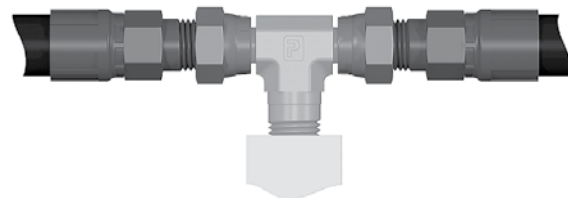
Reference Locations

Assembly and Installation: Please refer to Section S for the assembly and installation instructions for Pipe Swivels.

Standard material specifications: Please refer to Table U1 located in the Appendix Section.



Adapter Port Connection



NPSM / NPT Union

Fig. G1 — Illustration of the flexibility of the NPT Port and Hose Adapter system

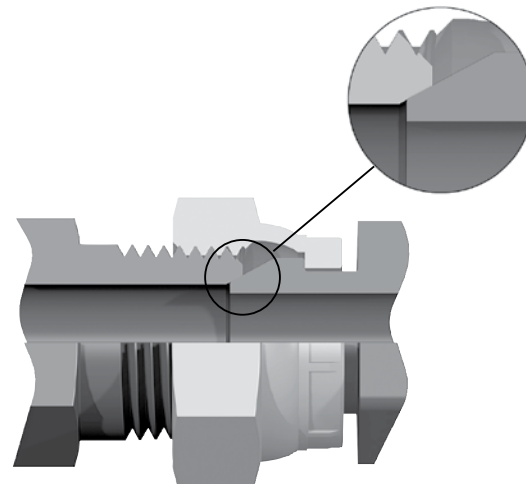


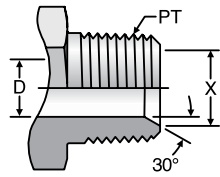
Fig. G2 — Illustration showing how NPSM swivel adapters seal on mating chamfer in male pipe thread

TABLE
OF
CONTENTS

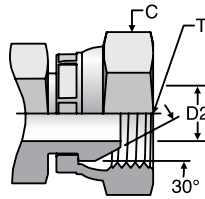
VISUAL
INDEX

G

Pipe Swivel (NPSM) Ends



Male Pipe End



NPSM Pipe Swivel

TABLE
OF
CONTENTS

VISUAL
INDEX

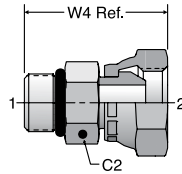
	NPT/NPTF Thread	NPSM Thread	Hex - Swivel	Drill - Male	Drill - Swivel	Chamfer Dia.	Thread Length
Size	PT NPT/NPTF	T NPSM	C (in.)	D (in.)	D2 (in.)	X (in.)	L (in.)
2	1/8-27	1/8-27	9/16	0.188	0.156	0.281	0.38
4	1/4-18	1/4-18	11/16	0.281	0.219	0.344	0.56
6	3/8-18	3/8-18	7/8	0.406	0.344	0.469	0.56
8	1/2-14	1/2-14	1	0.531	0.469	0.625	0.75
12	3/4-14	3/4-14	1 1/4	0.719	0.641	0.813	0.75
16	1-11 1/2	1-11 1/2	1 1/2	0.938	0.844	1.031	0.94
20	1 1/4-11 1/2	1 1/4-11 1/2	1 7/8	1.250	1.141	1.344	0.97
24	1 1/2-11 1/2	1 1/2-11 1/2	2 1/8	1.500	1.359	1.625	1.00
32	2-11 1/2	2-11 1/2	2 5/8	1.938	1.813	2.063	1.03

Dimensions and pressures for reference only, subject to change.

0507

Straight Thread Adapter
SAE-ORB / NPSM Swivel

SAE 140157

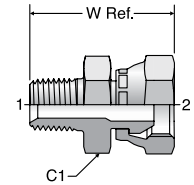


TUBE FITTING PART #	END SIZE		C2 HEX BODY (in.)	W4 (in.)	Dynamic Pressure (x 1,000 PSI)		
	1	2			-S	-SS	-B
	UN/UNF-2A	NPSM					
0507-4-2	7/16 - 20	1/8 - 27	9/16	1.21	6.0	6.0	3.3
0507-4-4	7/16 - 20	1/4 - 18	9/16	1.32	6.0	6.0	3.3
0507-5-4	1/2 - 20	1/4 - 18	5/8	1.32	6.0	6.0	3.3
0507-6-4	9/16 - 18	1/4 - 18	11/16	1.35	6.0	6.0	3.3
0507-6-6	9/16 - 18	3/8 - 18	11/16	1.37	6.0	6.0	3.3
0507-6-8	9/16 - 18	1/2 - 14	3/4	1.57	5.0	5.0	3.3
0507-8-4	3/4 - 16	1/4 - 18	7/8	1.43	6.0	6.0	3.3
0507-8-6	3/4 - 16	3/8 - 18	7/8	1.45	6.0	6.0	3.3
0507-8-8	3/4 - 16	1/2 - 14	7/8	1.56	5.0	5.0	3.3
0507-8-12	3/4 - 16	3/4 - 14	1	1.79	4.0	4.0	2.6
0507-10-6	7/8 - 14	3/8 - 18	1	1.59	5.0	5.0	3.3
0507-10-8	7/8 - 14	1/2 - 14	1	1.73	5.0	5.0	3.3
0507-10-12	7/8 - 14	3/4 - 14	1 1/4	1.88	4.0	4.0	2.6
0507-12-8	1 1/16 - 12	1/2 - 14	1 1/4	1.88	5.0	5.0	3.3
0507-12-12	1 1/16 - 12	3/4 - 14	1 1/4	1.97	4.0	4.0	2.6
0507-12-16	1 1/16 - 12	1 - 11 1/2	1 1/2	2.12	3.0	3.0	1.9
0507-14-12	1 3/16 - 12	3/4 - 14	1 3/8	1.97	4.0	4.0	2.6
0507-16-12	1 5/16 - 12	3/4 - 14	1 1/2	1.90	4.0	4.0	2.6
0507-16-16	1 5/16 - 12	1 - 11 1/2	1 1/2	2.12	3.0	3.0	1.9
0507-20-16	1 5/8 - 12	1 - 11 1/2	1 7/8	2.20	3.0	3.0	1.9
0507-20-20	1 5/8 - 12	1 1/4 - 11 1/2	1 7/8	2.21	2.5	2.5	1.6
0507-24-24	1 7/8 - 12	1 1/2 - 11 1/2	2 1/8	2.39	2.0	2.0	1.3
0507-32-32	2 1/2 - 12	2 - 11 1/2	2 3/4	2.49	1.5	1.5	1.0

0107

Male Pipe Adapter
NPTF / NPSM Swivel

SAE 140130

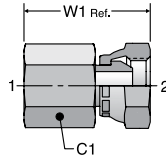


TUBE FITTING PART #	END SIZE		C1 HEX (in.)	W (in.)	Dynamic Pressure (x 1,000 PSI)		
	1	2			-S	-SS	-B
	NPTF	NPSM					
0107-2-2	1/8 - 27	1/8 - 27	9/16	1.09	6.0	6.0	3.3
0107-2-4	1/8 - 27	1/4 - 18	5/8	1.24	6.0	6.0	3.3
0107-4-2	1/4 - 18	1/8 - 27	11/16	1.39	6.0	6.0	3.3
0107-4-4	1/4 - 18	1/4 - 18	11/16	1.43	6.0	6.0	3.3
0107-4-6	1/4 - 18	3/8 - 18	13/16	1.45	6.0	6.0	3.3
0107-4-8	1/4 - 18	1/2 - 14	15/16	1.44	5.0	5.0	3.3
0107-6-4	3/8 - 18	1/4 - 18	11/16	1.49	6.0	6.0	3.3
0107-6-6	3/8 - 18	3/8 - 18	7/8	1.51	6.0	6.0	3.3
0107-6-8	3/8 - 18	1/2 - 14	15/16	1.73	5.0	5.0	3.3
0107-8-4	1/2 - 14	1/4 - 18	1	1.75	6.0	6.0	3.3
0107-8-6	1/2 - 14	3/8 - 18	7/8	1.70	6.0	6.0	3.3
0107-8-8	1/2 - 14	1/2 - 14	1	1.91	5.0	5.0	3.3
0107-8-12	1/2 - 14	3/4 - 14	1 1/4	2.04	4.0	4.0	2.6
0107-12-8	3/4 - 14	1/2 - 14	1 1/8	1.91	5.0	5.0	2.6
0107-12-12	3/4 - 14	3/4 - 14	1 1/4	2.04	4.0	4.0	2.6
0107-12-16	3/4 - 14	1 - 11 1/2	1 1/2	2.17	3.0	3.0	1.9
0107-16-12	1 - 11 1/2	3/4 - 14	1 3/8	2.29	4.0	4.0	1.9
0107-16-16	1 - 11 1/2	1 - 11 1/2	1 1/2	2.37	3.0	3.0	1.9
0107-16-20	1 - 11 1/2	1 1/4 - 11 1/2	1 3/4	2.38	2.5	2.5	1.6
0107-20-16	1 1/4 - 11 1/2	1 - 11 1/2	1 7/8	2.46	3.0	3.0	1.6
0107-20-20	1 1/4 - 11 1/2	1 1/4 - 11 1/2	1 7/8	2.47	2.5	2.5	1.6
0107-20-24	1 1/4 - 11 1/2	1 1/2 - 11 1/2	2 1/8	2.58	2.0	2.0	1.3
0107-24-20	1 1/2 - 11 1/2	1 1/4 - 11 1/2	2 1/8	2.51	2.5	2.5	1.3
0107-24-24	1 1/2 - 11 1/2	1 1/2 - 11 1/2	2 1/8	2.61	2.0	2.0	1.3
0107-32-32	2 - 11 1/2	2 - 11 1/2	2 5/8	2.80	1.5	1.5	1.0

0207

Female Pipe Adapter
NPTF / NPSM Swivel

SAE 140131

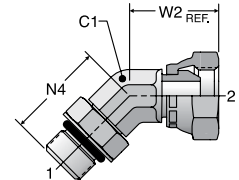


TUBE FITTING PART #	END SIZE		C1 HEX (in.)	W1 (in.)	Dynamic Pressure (x 1,000 PSI)		
	1	2			-S	-SS	-B
	NPTF	NPSM					
0207-2-2	1/8 - 27	1/8 - 27	9/16	1.02	6.0	6.0	3.3
0207-2-4	1/8 - 27	1/4 - 18	11/16	1.33	6.0	6.0	3.3
0207-4-2	1/4 - 18	1/8 - 27	9/16	1.32	6.0	6.0	3.3
0207-4-4	1/4 - 18	1/4 - 18	11/16	1.43	6.0	6.0	3.3
0207-6-4	3/8 - 18	1/4 - 18	7/8	1.49	6.0	6.0	3.3
0207-6-6	3/8 - 18	3/8 - 18	7/8	1.51	6.0	6.0	3.3
0207-6-8	3/8 - 18	1/2 - 14	1	1.64	5.0	5.0	3.3
0207-8-4	1/2 - 14	1/4 - 18	1	1.70	5.0	5.0	3.3
0207-8-6	1/2 - 14	3/8 - 18	1	1.73	5.0	5.0	3.3
0207-8-8	1/2 - 14	1/2 - 14	1	1.79	5.0	5.0	3.3
0207-12-8	3/4 - 14	1/2 - 14	1 1/4	1.85	4.0	4.0	2.6
0207-12-12	3/4 - 14	3/4 - 14	1 1/4	1.97	4.0	4.0	2.6
0207-16-12	1 - 11 1/2	3/4 - 14	1 1/2	2.28	3.0	3.0	1.9
0207-16-16	1 - 11 1/2	1 - 11 1/2	1 1/2	2.37	3.0	3.0	1.9
0207-20-20	1 1/4 - 11 1/2	1 1/4 - 11 1/2	1 7/8	2.38	2.5	2.5	1.6
0207-24-24	1 1/2 - 11 1/2	1 1/2 - 11 1/2	2 1/8	2.42	2.0	2.0	1.3
0207-32-32	2 - 11 1/2	2 - 11 1/2	2 5/8	2.55	1.5	1.5	1.0

3507

45° Straight Thread Elbow
SAE-ORB / NPSM Swivel

SAE 140357



TUBE FITTING PART #	END SIZE		C1 HEX (in.)	N4 (in.)	W2 (in.)	Dynamic Pressure (x 1,000 PSI)		
	1	2				-S	-SS	-B
	UN/UNF-2A	NPSM						
3507-4-4	7/16 - 20	1/4 - 18	7/16	1.05	0.79	6.0	6.0	3.3
3507-6-4	9/16 - 18	1/4 - 18	9/16	1.11	0.94	6.0	6.0	3.3
3507-6-6	9/16 - 18	3/8 - 18	9/16	1.14	1.03	6.0	6.0	3.3
3507-6-8	9/16 - 18	1/2 - 14	3/4	1.08	1.16	5.0	5.0	3.3
3507-8-6	3/4 - 16	3/8 - 18	3/4	1.30	1.02	6.0	6.0	3.3
3507-8-8	3/4 - 16	1/2 - 14	3/4	1.30	1.18	5.0	5.0	3.3
3507-8-12	3/4 - 16	3/4 - 14	3/4	1.41	1.37	3.0	3.0	1.9
3507-10-6	7/8 - 14	3/8 - 18	1 1/16	1.35	0.98	5.0	5.0	3.3
3507-10-8	7/8 - 14	1/2 - 14	7/8	1.52	1.17	5.0	5.0	3.3
3507-10-12	7/8 - 14	3/4 - 14	1 1/16	1.36	1.40	3.0	3.0	1.9
3507-12-8	1 1/16 - 12	1/2 - 14	1 1/16	1.73	1.12	5.0	5.0	3.3
3507-12-12	1 1/16 - 12	3/4 - 14	1 1/16	1.73	1.37	3.0	3.0	1.9
3507-16-16	1 5/16 - 12	1 - 11 1/2	1 5/16	1.86	1.52	2.5	2.5	1.6

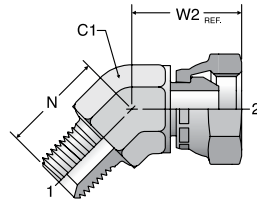
Dimensions and pressures for reference only, subject to change.



3107

45° Male Pipe Elbow
NPTF / NPSM Swivel

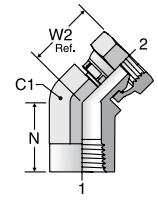
SAE 140330



TUBE FITTING PART #	END SIZE		C1 HEX (in.)	N (in.)	W2 (in.)	Dynamic Pressure (x 1,000 PSI)		
	1 NPTF	2 NPSM				-S	-SS	-B
	3107-2-2	1/8 - 27				1/8 - 27	7/16	0.52
3107-4-4	1/4 - 18	1/4 - 18	9/16	0.86	0.91	6.0	6.0	3.3
3107-6-6	3/8 - 18	3/8 - 18	3/4	0.95	1.10	6.0	6.0	3.3
3107-6-8	3/8 - 18	1/2 - 14	1 1/16	1.09	1.16	5.0	5.0	3.3
3107-8-4	1/2 - 14	1/4 - 18	1 1/16	1.34	0.96	5.0	5.0	3.3
3107-8-6	1/2 - 14	3/8 - 18	7/8	1.17	1.10	6.0	6.0	3.3
3107-8-8	1/2 - 14	1/2 - 14	7/8	1.17	1.17	5.0	5.0	3.3
3107-8-12	1/2 - 14	3/4 - 14	1 1/16	1.50	1.24	3.0	3.0	1.9
3107-12-8	3/4 - 14	1/2 - 14	1 1/16	1.20	1.23	4.0	4.0	1.9
3107-12-12	3/4 - 14	3/4 - 14	1 1/16	1.20	1.37	3.0	3.0	1.9
3107-12-16	3/4 - 14	1 - 11 1/2	1 5/16	1.50	1.32	2.5	2.5	1.6
3107-16-12	1 - 11 1/2	3/4 - 14	1 5/16	1.48	1.47	3.0	3.0	1.6
3107-16-16	1 - 11 1/2	1 - 11 1/2	1 5/16	1.48	1.52	2.5	2.5	1.6
3107-20-16	1 1/4 - 11 1/2	1 - 11 1/2	1 5/8	1.75	1.55	2.5	2.5	1.3
3107-20-20	1 1/4 - 11 1/2	1 1/4 - 11 1/2	1 5/8	1.67	1.61	2.0	2.0	1.3
3107-24-24	1 1/2 - 11 1/2	1 1/2 - 11 1/2	1 7/8	1.77	1.77	2.0	2.0	1.3
3107-32-32	2 - 11 1/2	2 - 11 1/2	2 1/2	2.11	1.89	1.1	1.1	0.7

3207

45° Female Pipe Elbow
NPTF / NPSM Swivel



TUBE FITTING PART #	END SIZE		C1 HEX (in.)	N (in.)	W2 (in.)	Dynamic Pressure (x 1,000 PSI)		
	1 NPTF	2 NPSM				-S	-SS	-B
	3207-4-4	1/4 - 18				1/4 - 18	3/4	0.91
3207-6-6	3/8 - 18	3/8 - 18	7/8	1.00	0.97	4.5	4.5	2.9
3207-8-8	1/2 - 14	1/2 - 14	1 1/16	1.01	1.12	3.0	3.0	1.9
3207-12-12	3/4 - 14	3/4 - 14	1 5/16	1.25	1.31	3.0	3.0	1.9
3207-16-16	1 - 11 1/2	1 - 11 1/2	1 5/8	1.44	1.55	1.8	1.8	1.1

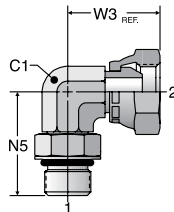
TABLE OF CONTENTS

VISUAL INDEX

2507

Straight Thread Elbow
SAE-ORB / NPSM Swivel

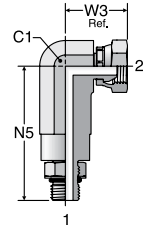
SAE 140257



TUBE FITTING PART #	END SIZE		C1 HEX (in.)	N5 (in.)	W3 (in.)	Dynamic Pressure (x 1,000 PSI)		
	1 UN/UNF-2A	2 NPSM				-S	-SS	-B
	2507-4-4	7/16 - 20				1/4 - 18	7/16	1.03
2507-4-6	7/16 - 20	3/8 - 18	9/16	1.28	1.23	6.0	6.0	3.3
2507-6-4	9/16 - 18	1/4 - 18	9/16	1.25	1.06	6.0	6.0	3.3
2507-6-6	9/16 - 18	3/8 - 18	9/16	1.25	1.10	6.0	6.0	3.3
2507-6-8	9/16 - 18	1/2 - 14	3/4	1.41	1.29	5.0	5.0	3.3
2507-8-4	3/4 - 16	1/4 - 18	3/4	1.30	1.09	6.0	6.0	3.3
2507-8-6	3/4 - 16	3/8 - 18	3/4	1.45	1.19	6.0	6.0	3.3
2507-8-8	3/4 - 16	1/2 - 14	3/4	1.45	1.33	5.0	5.0	3.3
2507-8-12	3/4 - 16	3/4 - 14	3/4	1.62	1.65	3.0	3.0	1.9
2507-10-6	7/8 - 14	3/8 - 18	7/8	1.70	1.26	5.0	5.0	3.3
2507-10-8	7/8 - 14	1/2 - 14	7/8	1.70	1.40	5.0	5.0	3.3
2507-10-12	7/8 - 14	3/4 - 14	7/8	1.78	1.62	3.0	3.0	1.9
2507-12-8	1 1/16 - 12	1/2 - 14	1 1/16	1.94	1.50	5.0	5.0	3.3
2507-12-12	1 1/16 - 12	3/4 - 14	1 1/16	1.94	1.65	3.0	3.0	1.9
2507-12-16	1 1/16 - 12	1 - 11 1/2	1 3/16	2.08	1.91	2.5	2.5	1.6
2507-16-12	1 5/16 - 12	3/4 - 14	1 3/16	2.08	1.89	3.0	3.0	1.9
2507-16-16	1 5/16 - 12	1 - 11 1/2	1 5/16	2.05	1.91	2.5	2.5	1.6
2507-20-20	1 5/8 - 12	1 1/4 - 11 1/2	1 5/8	2.25	2.16	2.0	2.0	1.3
2507-24-24	1 7/8 - 12	1 1/2 - 11 1/2	1 7/8	2.39	2.31	1.1	1.1	0.7

5507

Long Straight Thread Elbow
SAE-ORB / NPSM Swivel



TUBE FITTING PART #	END SIZE		C1 HEX (in.)	N5 (in.)	W3 (in.)	Dynamic Pressure (x 1,000 PSI)		
	1 UN/UNF-2A	2 NPSM				-S	-SS	-B
	5507-4-4	7/16 - 20				1/4 - 18	3/4	2.19
5507-6-6	9/16 - 18	3/8 - 18	7/8	2.59	1.20	6.0	6.0	3.3
5507-8-6	3/4 - 16	3/8 - 18	7/8	2.47	1.20	6.0	6.0	3.3

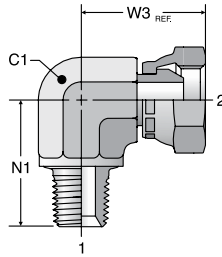
Dimensions and pressures for reference only, subject to change.



2107

Male Pipe Elbow
NPTF / NPSM Swivel

SAE 140230



5607

Long Male Pipe Elbow
NPTF / NPSM Swivel

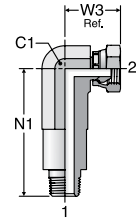


TABLE OF CONTENTS

VISUAL INDEX

G

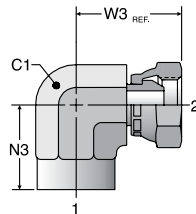
TUBE FITTING PART #	END SIZE		C1 HEX (in.)	N1 (in.)	W3 (in.)	Dynamic Pressure (x 1,000 PSI)		
	1 NPTF	2 NPSM				-S	-SS	-B
	2107-2-2	1/8 - 27				1/8 - 27	7/16	0.72
2107-2-4	1/8 - 27	1/4 - 18	7/16	1.00	0.97	6.0	6.0	3.3
2107-4-2	1/4 - 18	1/8 - 27	9/16	1.02	1.05	6.0	6.0	3.3
2107-4-4	1/4 - 18	1/4 - 18	9/16	1.09	1.06	6.0	6.0	3.3
2107-4-6	1/4 - 18	3/8 - 18	3/4	1.09	1.28	6.0	6.0	3.3
2107-6-4	3/8 - 18	1/4 - 18	3/4	1.22	1.17	6.0	6.0	3.3
2107-6-6	3/8 - 18	3/8 - 18	3/4	1.22	1.28	6.0	6.0	3.3
2107-6-8	3/8 - 18	1/2 - 14	3/4	1.22	1.33	5.0	5.0	3.3
2107-8-4	1/2 - 14	1/4 - 18	7/8	1.69	1.18	6.0	6.0	3.3
2107-8-6	1/2 - 14	3/8 - 18	7/8	1.47	1.35	6.0	6.0	3.3
2107-8-8	1/2 - 14	1/2 - 14	7/8	1.47	1.40	5.0	5.0	3.3
2107-8-12	1/2 - 14	3/4 - 14	1 1/16	1.47	1.65	3.0	3.0	1.9
2107-12-6	3/4 - 14	3/8 - 18	1 1/16	1.59	1.48	4.0	4.0	2.6
2107-12-8	3/4 - 14	1/2 - 14	1 1/16	1.59	1.53	4.0	4.0	2.6
2107-12-12	3/4 - 14	3/4 - 14	1 1/16	1.59	1.65	3.0	3.0	1.9
2107-12-16	3/4 - 14	1 - 11 1/2	1 3/16	2.19	1.72	2.5	2.5	1.6
2107-16-12	1 - 11 1/2	3/4 - 14	1 5/16	1.97	1.82	3.0	3.0	1.9
2107-16-16	1 - 11 1/2	1 - 11 1/2	1 5/16	1.97	1.91	2.5	2.5	1.6
2107-16-20	1 - 11 1/2	1 1/4 - 11 1/2	1 7/16	2.41	1.87	2.0	2.0	1.3
2107-20-16	1 1/4 - 11 1/2	1 - 11 1/2	1 5/8	2.62	1.98	2.5	2.5	1.6
2107-20-20	1 1/4 - 11 1/2	1 1/4 - 11 1/2	1 5/8	2.38	2.11	2.0	2.0	1.3
2107-24-24	1 1/2 - 11 1/2	1 1/2 - 11 1/2	1 7/8	2.64	2.31	2.0	2.0	1.0
2107-32-32	2 - 11 1/2	2 - 11 1/2	2 1/2	3.00	2.70	1.1	1.1	0.7

TUBE FITTING PART #	END SIZE		C1 HEX (in.)	N1 (in.)	W3 (in.)	Dynamic Pressure (x 1,000 PSI)		
	1 NPTF	2 NPSM				-S	-SS	-B
	5607-2-2	1/8 - 27				1/8 - 27	9/16	1.64
5607-4-4	1/4 - 18	1/4 - 18	3/4	2.25	1.16	6.0	6.0	3.3
5607-6-6	3/8 - 18	3/8 - 18	7/8	2.76	1.20	6.0	6.0	3.3
5607-8-8	1/2 - 14	1/2 - 14	1 1/16	3.19	1.48	5.0	5.0	3.3
5607-12-12	3/4 - 14	3/4 - 14	1 5/16	3.66	1.69	3.0	3.0	1.9
5607-16-16	1 - 11 1/2	1 - 11 1/2	1 7/8	4.31	2.15	2.5	2.5	1.6

2207

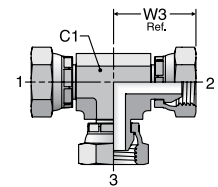
Female Pipe Elbow
NPTF / NPSM Swivel

SAE 140231



077T

NPSM Union Tee
NPSM Swivel (all three ends)



TUBE FITTING PART #	END SIZE		C1 HEX (in.)	N3 (in.)	W3 (in.)	Dynamic Pressure (x 1,000 PSI)		
	1 NPTF	2 NPSM				-S	-SS	-B
	2207-2-2	1/8 - 27				1/8 - 27	9/16	0.66
2207-4-4	1/4 - 18	1/4 - 18	3/4	0.88	1.17	5.0	5.0	3.3
2207-4-6	1/4 - 18	3/8 - 18	7/8	0.88	1.26	4.5	4.5	2.9
2207-6-6	3/8 - 18	3/8 - 18	7/8	1.02	1.26	4.5	4.5	2.9
2207-8-6	1/2 - 14	3/8 - 18	1 1/16	1.37	1.34	3.0	3.0	1.9
2207-8-8	1/2 - 14	1/2 - 14	1 1/16	1.23	1.53	3.0	3.0	1.9
2207-12-12	3/4 - 14	3/4 - 14	1 5/16	1.36	1.82	3.0	3.0	1.9
2207-16-16	1 - 11 1/2	1 - 11 1/2	1 5/8	1.62	2.10	1.8	1.8	1.1
2207-20-20	1 1/4 - 11 1/2	1 1/4 - 11 1/2	1 7/8	1.70	2.21	1.5	1.5	1.0
2207-24-24	1 1/2 - 11 1/2	1 1/2 - 11 1/2	2 1/2	2.08	2.83	1.5	1.5	1.0
2207-32-32	2 - 11 1/2	2 - 11 1/2	2 13/16	2.39	3.00	1.1	1.1	0.7

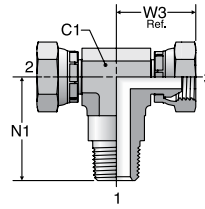
TUBE FITTING PART #	END SIZE			C1 HEX (in.)	W3 (in.)	Dynamic Pressure (x 1,000 PSI)		
	1 NPSM	2 NPSM	3 NPSM			-S	-SS	-B
	077T-2	1/8 - 27	1/8 - 27			1/8 - 27	7/16	0.89
077T-4	1/4 - 18	1/4 - 18	1/4 - 18	9/16	1.06	6.0	7.2	3.3
077T-6	3/8 - 18	3/8 - 18	3/8 - 18	3/4	1.15	6.0	7.2	3.3
077T-8	1/2 - 14	1/2 - 14	1/2 - 14	3/4	1.29	5.0	6.0	3.3
077T-12	3/4 - 14	3/4 - 14	3/4 - 14	1 1/16	1.65	3.0	3.6	1.9

Dimensions and pressures for reference only, subject to change.



217T

Male Pipe Branch Tee
 NPTF / NPSM Swivel /
 NPSM Swivel



227T

Female Pipe Branch Tee
 NPTF / NPSM Swivel /
 NPSM Swivel

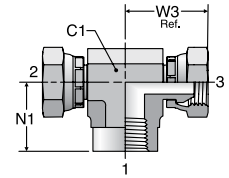


TABLE
 OF
 CONTENTS

VISUAL
 INDEX

TUBE FITTING PART #	END SIZE			C1 HEX (in.)	N1 (in.)	W3 (in.)	Dynamic Pressure (x 1,000 PSI)		
	1	2	3				-S	-SS	-B
	NPTF	NPSM	NPSM						
217T-2-2	1/8 - 27	1/8 - 27	1/8 - 27	9/16	0.97	0.92	6.0	6.0	3.3
217T-4-4	1/4 - 18	1/4 - 18	1/4 - 18	9/16	1.19	1.03	6.0	6.0	3.3
217T-6-6	3/8 - 18	3/8 - 18	3/8 - 18	3/4	1.50	1.15	6.0	6.0	3.3
217T-8-6	1/2 - 14	3/8 - 18	1/2 - 14	3/4	1.69	1.21	6.0	6.0	3.3
217T-8-8	1/2 - 14	1/2 - 14	1/2 - 14	3/4	1.81	1.35	5.0	5.0	3.3
217T-12-12	3/4 - 14	3/4 - 14	3/4 - 14	1 1/16	2.00	1.60	3.0	3.0	1.9
217T-16-16	1 - 11 1/2	1 - 11 1/2	1 - 11 1/2	1 1/16	2.37	1.86	2.5	2.5	1.6

TUBE FITTING PART #	END SIZE			C1 HEX (in.)	N1 (in.)	W3 (in.)	Dynamic Pressure (x 1,000 PSI)		
	1	2	3				-S	-SS	-B
	NPTF	NPSM	NPSM						
227T-4-4	1/4 - 18	1/4 - 18	1/4 - 18	3/4	0.94	1.13	5.0	5.0	3.2
227T-6-6	3/8 - 18	3/8 - 18	3/8 - 18	7/8	1.00	1.20	4.5	4.5	2.9
227T-8-8	1/2 - 14	1/2 - 14	1/2 - 14	1 1/16	1.17	1.46	3.0	3.0	1.9
227T-12-12	3/4 - 14	3/4 - 14	3/4 - 14	1 3/16	1.44	1.60	3.0	3.0	1.9

Dimensions and pressures for reference only, subject to change.




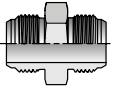
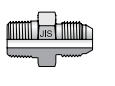
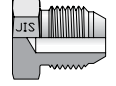
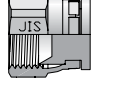
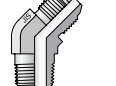

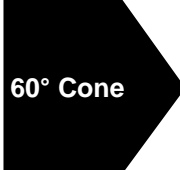
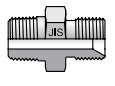
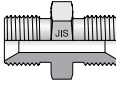
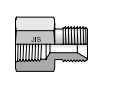
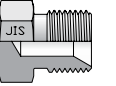
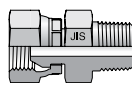
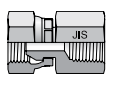
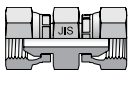
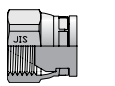
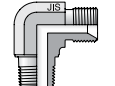
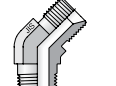


TABLE
OF
CONTENTS

VISUAL
INDEX


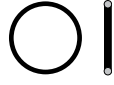
JIS Fittings

H

TABLE
 OF
 CONTENTS

 <p>30° Flare</p>	<p>HT4 JIS Union / 30° Flare</p>  <p>H5</p>	<p>F3T4 BSPT / 30° Flare</p>  <p>H5</p>	<p>PNMT4 Plug</p>  <p>H5</p>	<p>FNMT4 Cap</p>  <p>H5</p>	<p>V3T4 BSPT / 30° Flare</p>  <p>H5</p>
<p>C3T4 BSPT / 30° Flare</p>  <p>H5</p>	 <p>60° Cone</p>	<p>F3P4 BSPT / 60° Cone</p>  <p>H6</p>	<p>HP4 Union</p>  <p>H6</p>	<p>G3P4 BSPT / 60° Cone</p>  <p>H6</p>	<p>PNMP4 Plug</p>  <p>H6</p>
<p>F63P4 60° Swivel / BSPT</p>  <p>H6</p>	<p>G63P4 60° Swivel / BSPT</p>  <p>H6</p>	<p>HP46 Union Swivel</p>  <p>H7</p>	<p>FNMP4 Cap</p>  <p>H7</p>	<p>C3P4 BSPT / 60° Cone</p>  <p>H7</p>	<p>V3P4 BSPT / 60° Cone</p>  <p>H7</p>
 <p>B2351 Port</p>	<p>P47OMN Hex Head Plug</p>  <p>H7</p>				

O-Rings and Seals (Shown in Section N)

 <p>JIS O-Rings and Seals</p>	<p>JIS B2351 O-Ring</p>  <p>N7</p>
---	--

Dimensions and pressures for reference only, subject to change.

JIS Fittings

Parker introduced Japanese Industrial Standard (JIS) adapters in the early 1990s to address market requirements for OEM and replacement fittings. These fittings are typically used as hose adapters on equipment designed and/or manufactured in Japan and Korea. Parker's JIS adapters are designed with 30° flare and 60° cone connections and typically incorporate BSP threads.

Parker JIS adapters are designed with BSPP and BSPT port ends and two styles of hose ends: T4 (30° flare, BSPP threads) and P4 (60° cone, BSPP threads). Two additional Parker series of fittings, KA (Komatsu flare) and K4 (BS B5200) adapters, are similar to JIS style fittings and appear in sections I and J of this catalog.

The T4 and P4 interfaces, as shown in Fig. H1, provide end user flexibility of connecting to the most common Parker hose ends available as listed in Table H1.

Parker's JIS adapter offering that uses the BSPP port connection are manufactured in accordance with the JIS B2351 type "O" port connection which is commonly used for higher pressure systems. Fig. H2 illustrates this port connection and Table H2 shows appropriate JIS B2351 O-rings and dash sizes.

It should be noted that Parker offers two very similar cone style BSPP adapters — P4 and K4. Parker's K4 (60 cone, BSPP) fittings conform to BS5200, while Parker's JIS cone adapters meet JIS B8363 specifications. **These fittings, while very similar, are not interchangeable.** See the I section of this catalog for more specific information on their differences.

Design and Construction

Construction: Shaped JIS adapters are manufactured from a hot forged construction. Straight adapters are manufactured from cold drawn barstock.

Threads: The standard JIS products are manufactured with the thread forms listed below:

BSPP Threads: ISO 228-1 G, JIS B 0202,
BSPT Threads: ISO 7/1, JIS B 0203

Identification: All Parker JIS fittings are stamped with "JIS" for positive identification and differentiation from similar style fittings.

Reference Locations

Dynamic Pressure Ratings: Please refer to the last column of part number tables located on the following pages of this section for the appropriate dynamic pressure ratings.

Standard Material Specifications: Please refer to Table U1 located in the Appendix section.

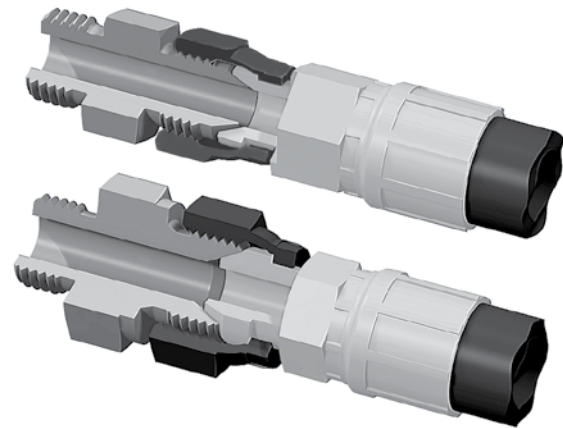


Fig. H1 – JIS T4 and P4 Interfaces

Adapter Connection End	Mating Parker Hose Fitting Series
P4 / P46	UT, GU, G1, G2
T4 / T46	FU

Table H1 – Parker JIS Fittings Hose Adaptability

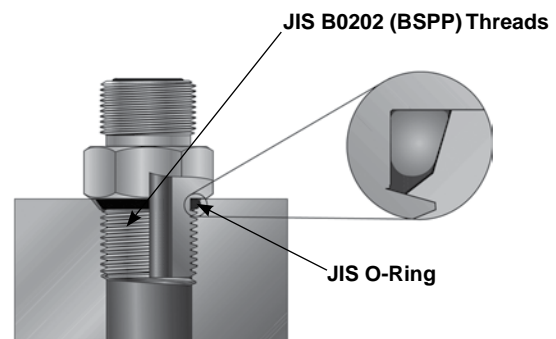


Fig. H2 – JIS B2351 Type "O" Port Connection

"G" Thread BSPP per ISO 228-1 JIS B 0202	Dash Size	Port O-Ring (See Pg. N6)
1/8-28	2	P8
1/4-19	4	P11
3/8-19	6	P14
1/2-14	8	P18
3/4-14	12	P24
1-11	16	P29

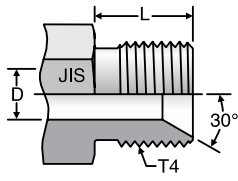
Table H2 – JIS B2351 Port Threads and O-Rings as shown in Fig. H2

Dimensions and pressures for reference only, subject to change.

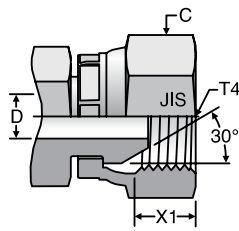
JIS Ends

TABLE
 OF
 CONTENTS

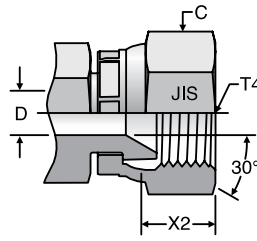
VISUAL
 INDEX



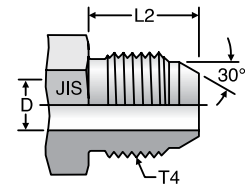
JIS Male, 60° Seat



**JIS Swivel
 for 60° Seat**



**JIS Swivel
 for 30° Flare**



JIS Male, 30° Flare

	BSPP Thread	Swivel Hex	Drill	Male Turn Back		Assembly Allowance	
Dash Size	T4 BSPP	C (in)	D (in)	L (in)	L2 (in)	X1 (in)	X2 (in)
4	1/4-19	.75	0.177	.570	.606	0.35	0.36
6	3/8-19	.88	0.275	.609	.684	0.29	0.38
8	1/2-14	1.06	0.433	.726	.763	0.46	0.53
12	3/4-14	1.44	0.625	.805	.842	0.55	0.56
16	1-11	1.63	0.828	.883	.881	0.53	0.58

Dimensions and pressures for reference only, subject to change.

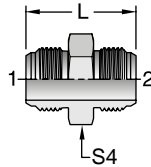
TABLE OF CONTENTS

VISUAL INDEX

H

HT4

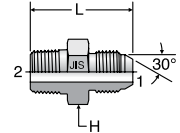
JIS Union Flare
30° Flare / 30° Flare



TUBE FITTING PART #	End Size		S4 Hex (in.)	L (in.)	Dynamic Pressure (x 1,000 PSI) -S
	1 BSPP	2 BSPP			
4 HT4	1/4-19	1/4-19	3/4	1.45	5.0
6 HT4	3/8-19	3/8-19	7/8	1.68	5.0
8 HT4	1/2-14	1/2-14	1 1/16	1.88	5.0
12 HT4	3/4-14	3/4-14	1 7/16	2.12	4.0
16 HT4	1-11	1-11	1 5/8	2.28	3.0

F3T4

Male Connector
30° Flare / BSPT

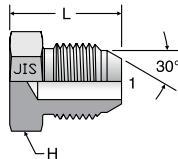


Mates with FU Style hose fittings

TUBE FITTING PART #	END SIZE		H HEX (in.)	L (in.)	Dynamic Pressure (x 1,000 PSI) S
	1 BSPP	2 BSPT			
4F3T4	1/4 - 19	1/4 - 19	0.75	1.46	5.0
4-6F3T4	1/4 - 19	3/8 - 19	0.88	1.51	5.0
6-4F3T4	3/8 - 19	1/4 - 19	0.88	1.59	5.0
6F3T4	3/8 - 19	3/8 - 19	0.88	1.59	5.0
8-6F3T4	1/2 - 14	3/8 - 19	1.06	1.70	5.0
8F3T4	1/2 - 14	1/2 - 14	1.06	1.89	5.0
12F3T4	3/4 - 14	3/4 - 14	1.44	2.10	4.0
16F3T4	1-11	1-11	1.63	2.30	3.0

PNMT4

Plug
30° Flare

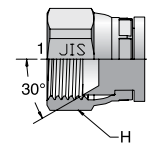


Mates with FU Style hose fittings

TUBE FITTING PART #	END SIZE 1 BSPP	H HEX (mm)	L (in.)	Dynamic Pressure (x 1,000 PSI) S
				4PNMT4
6PNMT4	3/8 - 19	19	0.97	5.0
8PNMT4	1/2 - 14	22	1.11	5.0
12PNMT4	3/4 - 14	30	1.26	4.0
16PNMT4	1-11	36	1.30	3.0

FNMT4

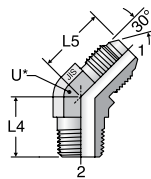
Cap
30° Flare



TUBE FITTING PART #	END SIZE 1 BSPP	H HEX (in.)	Dynamic Pressure (x 1,000 PSI) S
			4FNMT4
6FNMT4	3/8 - 19	0.88	5.0
8FNMT4	1/2 - 14	1.06	5.0
12FNMT4	3/4 - 14	1.44	4.0
16FNMT4	1-11	1.63	3.0

V3T4

45° Male Elbow
30° Flare / BSPT



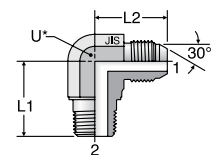
Mates with FU Style hose fittings

* Across wrench flats

TUBE FITTING PART #	END SIZE		L4 (in.)	L5 (in.)	U (in.)	Dynamic Pressure (x 1,000 PSI) S
	1 BSPP	2 BSPT				
4V3T4	1/4 - 19	1/4 - 19	0.75	0.87	0.56	5.0
6V3T4	3/8 - 19	3/8 - 19	0.87	0.97	0.75	5.0
8V3T4	1/2 - 14	1/2 - 14	1.06	1.10	0.88	5.0
12V3T4	3/4 - 14	3/4 - 14	1.18	1.24	1.06	4.0
16V3T4	1-11	1-11	1.37	1.26	1.31	3.0

C3T4

Male Elbow
30° Flare / BSPT



Mates with FU Style hose fittings

* Across wrench flats

TUBE FITTING PART #	END SIZE		L1 (in.)	L2 (in.)	U (in.)	Dynamic Pressure (x 1,000 PSI) S
	1 BSPP	2 BSPT				
4C3T4	1/4 - 19	1/4 - 19	1.00	0.98	0.56	5.0
6C3T4	3/8 - 19	3/8 - 19	1.18	1.14	0.75	5.0
8C3T4	1/2 - 14	1/2 - 14	1.42	1.33	0.88	5.0
12C3T4	3/4 - 14	3/4 - 14	1.69	1.50	1.06	4.0
16C3T4	1-11	1-11	1.97	1.74	1.31	3.0

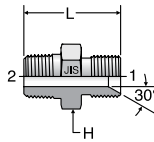
Dimensions and pressures for reference only, subject to change.



F3P4

Male Connector
60° Cone / BSPT

Mates with GU, G1 and G2 Style hose fittings

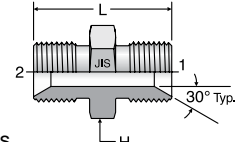


TUBE FITTING PART #	END SIZE		H HEX (in.)	L (in.)	Dynamic Pressure (x 1,000 PSI)
	1 BSPP	2 BSPT			S
	4F3P4	1/4 - 19			1/4 - 19
6F3P4	3/8 - 19	3/8 - 19	0.88	1.50	5.0
8F3P4	1/2 - 14	1/2 - 14	1.06	1.81	5.0
12F3P4	3/4 - 14	3/4 - 14	1.44	2.05	4.0
16F3P4	1-11	1-11	1.63	2.28	3.0

HP4

Union
60° Cone

Mates with GU, G1 and G2 Style hose fittings

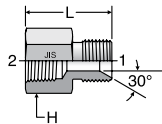


TUBE FITTING PART #	END SIZE		H HEX (in.)	L (in.)	Dynamic Pressure (x 1,000 PSI)
	1 & 2 BSPP				S
	4HP4	1/4 - 19			0.75
6HP4	3/8 - 19	0.88	1.50	5.0	
8HP4	1/2 - 14	1.06	1.81	5.0	
12HP4	3/4 - 14	1.44	2.05	4.0	
16HP4	1-11	1.63	2.28	3.0	

G3P4

Female Connector
60° Cone / BSPT

Mates with GU, G1 and G2 Style hose fittings

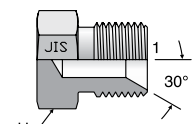


TUBE FITTING PART #	END SIZE		H HEX (in.)	L (in.)	Dynamic Pressure (x 1,000 PSI)
	1 BSPP	2 BSPT			S
	4G3P4	1/4 - 19			1/4 - 19
6G3P4	3/8 - 19	3/8 - 19	0.88	1.34	5.0
8G3P4	1/2 - 14	1/2 - 14	1.06	1.58	5.0
12G3P4	3/4 - 14	3/4 - 14	1.44	1.73	4.0
16G3P4	1-11	1-11	1.63	1.93	3.0

PNMP4

Plug
60° Cone

Mates with GU, G1 and G2 Style hose fittings

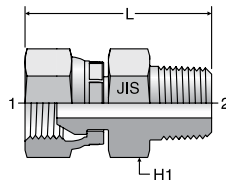


TUBE FITTING PART #	END SIZE		H HEX (mm)	Dynamic Pressure (x 1,000 PSI)
	1 BSPP			S
	4PNMP4	1/4 - 19		17
6PNMP4	3/8 - 19	19	5.0	
8PNMP4	1/2 - 14	22	5.0	
12PNMP4	3/4 - 14	30	4.0	
16PNMP4	1-11	36	3.0	

F63P4

Swivel Male Connector
60° Swivel / BSPT

Mates with UT Style hose fittings

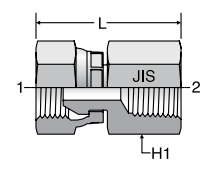


TUBE FITTING PART #	END SIZE		H1 HEX (in.)	L (in.)	Dynamic Pressure (x 1,000 PSI)
	1 BSPP	2 BSPT			S
	4F63P4	1/4 - 19			1/4 - 19
6F63P4	3/8 - 19	3/8 - 19	0.88	1.94	5.0
8F63P4	1/2 - 14	1/2 - 14	1.06	2.25	5.0
12F63P4	3/4 - 14	3/4 - 14	1.44	2.55	4.0
16F63P4	1-11	1-11	1.63	2.77	3.0

G63P4

Swivel Female Connector
60° Swivel / BSPT

Mates with UT Style hose fittings



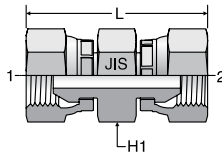
TUBE FITTING PART #	END SIZE		H1 HEX (in.)	L (in.)	Dynamic Pressure (x 1,000 PSI)
	1 BSPP	2 BSPT			S
	4G63P4	1/4 - 19			1/4 - 19
6G63P4	3/8 - 19	3/8 - 19	0.88	1.78	5.0
8G63P4	1/2 - 14	1/2 - 14	1.06	2.02	5.0
12G63P4	3/4 - 14	3/4 - 14	1.44	2.20	4.0
16G63P4	1-11	1-11	1.63	2.52	3.0

Dimensions and pressures for reference only, subject to change.

HP46

Swivel Union Connector
60° Swivel

Mates with UT Style hose fittings

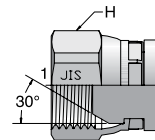


TUBE FITTING PART #	END SIZE		H1 HEX (in.)	L (in.)	Dynamic Pressure (x 1,000 PSI)	
	1 & 2 BSPP				S	
4HP46	1/4 - 19		0.75	2.12	5.0	
6HP46	3/8 - 19		0.88	2.37	5.0	
8HP46	1/2 - 14		1.06	2.73	5.0	
12HP46	3/4 - 14		1.44	2.96	4.0	
16HP46	1-11		1.63	3.24	3.0	

FNMP4

Cap
60° Cone

Mates with UT Style hose fittings



TUBE FITTING PART #	END SIZE		H HEX (in.)	Dynamic Pressure (x 1,000 PSI)	
	1 BSPP			S	
4FNMP4	1/4 - 19		0.75	5.0	
6FNMP4	3/8 - 19		0.88	5.0	
8FNMP4	1/2 - 14		1.06	5.0	
12FNMP4	3/4 - 14		1.44	4.0	
16FNMP4	1-11		1.63	3.0	

TABLE OF CONTENTS

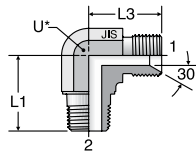
VISUAL INDEX

H

C3P4

90° Male Elbow
60° Cone / BSPT

Mates with GU, G1 and G2 Style hose fittings



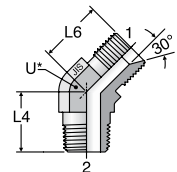
* Across wrench flats

TUBE FITTING PART #	END SIZE		L1 (in.)	L3 (in.)	U (in.)	Dynamic Pressure (x 1,000 PSI)	
	1 BSPP	2 BSPT				S	
4C3P4	1/4 - 19	1/4 - 19	1.00	0.96	0.56	5.0	
6C3P4	3/8 - 19	3/8 - 19	1.18	1.14	0.75	5.0	
8C3P4	1/2 - 14	1/2 - 14	1.42	1.28	0.88	5.0	
12C3P4	3/4 - 14	3/4 - 14	1.69	1.56	1.06	4.0	
16C3P4	1-11	1-11	1.97	1.74	1.31	3.0	

V3P4

45° Male Elbow
60° Cone / BSPT

Mates with GU, G1 and G2 Style hose fittings

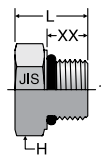


TUBE FITTING PART #	END SIZE		L4 (in.)	L6 (in.)	U (in.)	Dynamic Pressure (x 1,000 PSI)	
	1 BSPP	2 BSPT				S	
4V3P4	1/4 - 19	1/4 - 19	0.75	0.81	0.56	5.0	
6V3P4	3/8 - 19	3/8 - 19	0.87	0.91	0.75	5.0	
8V3P4	1/2 - 14	1/2 - 14	1.06	1.05	0.88	5.0	
12V3P4	3/4 - 14	3/4 - 14	1.18	1.18	1.06	4.0	
16V3P4	1-11	1-11	1.37	1.30	1.31	3.0	

P47OMN

Plug

Hex head plug for JIS B2351



TUBE FITTING PART #	END SIZE		H HEX (mm)	L (mm)	XX (mm)	Dynamic Pressure (x 1,000 PSI)	
	1 BSPP					S	
4P47OMN	1/4 - 19		19	19.1	11.2	5.0	
6P47OMN	3/8 - 19		22	20.0	11.2	5.0	
8P47OMN	1/2 - 14		27	24.1	14.5	5.0	
12P47OMN	3/4 - 14		36	26.9	14.5	4.0	
16P47OMN	1-11		41	31.0	18.5	3.0	

Dimensions and pressures for reference only, subject to change.

TABLE
OF
CONTENTS

VISUAL
INDEX



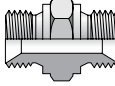
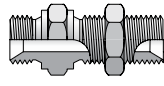
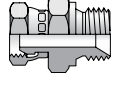
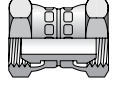
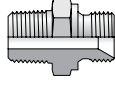
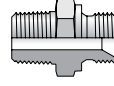
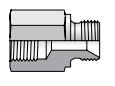
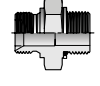

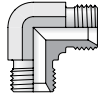
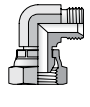
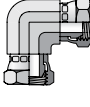

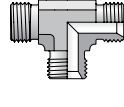
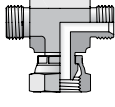
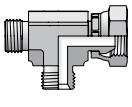
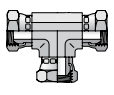





K4 BSP Adapters


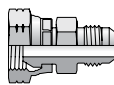
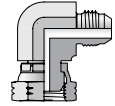


ENGINEERING YOUR SUCCESS.



**TABLE
 OF
 CONTENTS**

 <p>60° Cone BSP Adapters</p>	 <p>Straights</p>	<p>HMK4 Union</p>  <p>16</p>	<p>WMK4WL4NM Bulkhead Union</p>  <p>16</p>	<p>F6MK4 60° Swivel / 60° Cone</p>  <p>16</p>	<p>H6MK4 Swivel Union</p>  <p>16</p>
<p>FMK4 NPTF / 60° Cone</p>  <p>17</p>	<p>F3MK4 BSPT / 60° Cone</p>  <p>17</p>	<p>G4MK4 BSPP / 60° Cone</p>  <p>17</p>	<p>K4HF80 Metric BSP / 60° Cone</p>  <p>17</p>	 <p>Elbows</p>	<p>EMK4 Union Elbow</p>  <p>18</p>
<p>C6MK4 60° Swivel / 60° Cone</p>  <p>18</p>	<p>E6MK4 Swivel Union</p>  <p>19</p>	 <p>Tees</p>	<p>JMK4 Union Tee</p>  <p>19</p>	<p>S6MK4 60° Swivel Branch Tee</p>  <p>19</p>	<p>R6MK4 60° Swivel Run Tee</p>  <p>19</p>
<p>J6MK4 Swivel Union Tee</p>  <p>110</p>	 <p>Plug Caps</p>	<p>PNMK4 Hex Head Plug</p>  <p>18</p>	<p>FNMK4 Cap</p>  <p>18</p>		

Conversion Adapters (Shown in Section K)

 <p>K4 BSP Conversion Adapters</p>	<p>XHMK46 37° Flare / BSPP Swivel</p>  <p>K5</p>	<p>XEMK46 37° Flare / BSPP Swivel</p>  <p>K6</p>
--	---	---

O-Rings and Seals (Shown in Section N)

 <p>K4 BSP O-Rings and Seals</p>	<p>D9DT BSPP Bonded Seal</p>  <p>N7</p>
--	--

Dimensions and pressures for reference only, subject to change.

K4 BSP Adapters

Parker K4 (BSP) adapters are typically used as hose adapters on equipment designed and/or manufactured throughout Europe, especially equipment with ties to the UK, Scandinavia, the Netherlands, Spain and Italy. BSP cone adapters are similar in function to NPSM (07 Adapters) but with BSPP threads.

The metal-to-metal sealing is achieved by a single line of contact between the conical surface of the 60° cone seat and the corresponding surface of the ballnose or cone swivel, as shown in Fig. I1.

K4 adapters are manufactured in accordance with BS5200 standards. The 60° internal seat is designed for sealing with BSP hose swivel connections offered by many manufacturers. K4 adapters mate with Parker hose fitting series shown in Table I1.

Further enhancing the flexibility of the K4 adapter product line is the ability for the male BSP cone end of the straight fittings to also be used as a port adapter in ISO 1179-1 / DIN 3852 ports. This is accomplished with the addition of a bonded seal (often referred to as a “Dowty®” seal). This product feature is illustrated in Fig. I2.

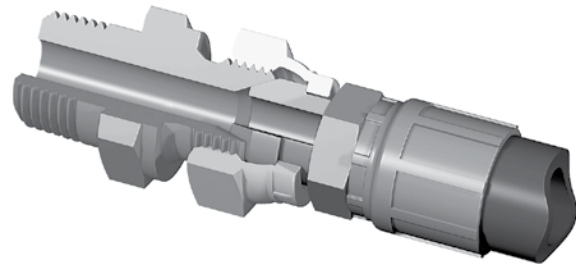


Fig. I1 – K4 Interface



Adapter Connection End	Mating Parker Hose Fitting Series
K4 / K46	D9/92, B1, B2, B4

Table I1 – Parker K4 Fittings Hose Adaptability

Design and Construction

Construction: Shaped K4 adapters are manufactured from a hot forged construction. Straight adapters are manufactured from cold drawn barstock.

Threads: The standard K4 products are manufactured with the thread forms listed below:

- BSPP Threads: ISO 228-1 G
- BSPT Threads: ISO 7/1, JIS B 0203
- NPTF Threads: SAE J476, ANSI B1.20.3, FED-STD-H28/8

Reference Locations

Dynamic Pressure Ratings: Please refer to the last column of the part number tables located on the following pages of this section for appropriate dynamic pressure ratings.

Standard Material Specification: Please refer to Table U2 in the Appendix Section.

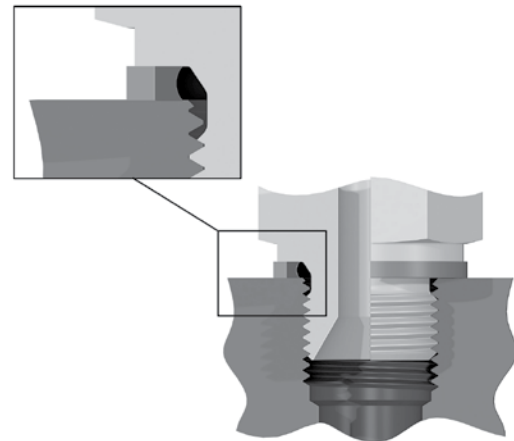


Fig. I2 – K4 End Used as a BSPP Port Adapter (in ISO 1179/ DIN 3852, Part 2 Port)

Dimensions and pressures for reference only, subject to change.

60° Cone Adapters: JIS vs. K4

K4 Adapters, while very similar to JIS P4 cones (shown in previous section), are not interchangeable.

Parker's P4 JIS 60° cone adapters are manufactured in accordance to JIS B8363 while Parker's K4 BSP adapters are manufactured in accordance to BS5200. The following are some pronounced differences that may help in distinguishing between the K4 and P4 fittings:

1. Thread length ("A" dimensions)
2. 60° angle diameter ("B" dimensions)
3. The undercut area (area between threads and hex body) on the straight K4 fittings incorporates a bonded seal "locating pilot" for bonded seal
4. Parker's JIS fittings are stamped with "JIS" on the forging body or hex of fitting

See Figs. I3 and I4 for details and see Tables I2 and I3 below for specific dimensional differences.

Size	BSPP Thread	M	A	B
2	1/8-28	0.38	0.418	0.276
4	1/4-19	0.51	0.570	0.394
6	3/8-19	0.65	0.609	0.531
8	1/2-14	0.82	0.726	0.650
12	3/4-14	1.04	0.805	0.866
16	1-11	1.30	0.883	1.102
20	1 1/4-11	1.64	0.945	1.417
24	1 1/2-11	1.87	0.962	1.654
32	2-11	2.34	1.102	2.126

Table I2 – Dimensions of JIS B8363 60° Cone Connection (JIS P4)

Size	BSPP Thread	M	A	B
2	1/8-28	0.38	0.315	0.295
4	1/4-19	0.51	0.433	0.409
6	3/8-19	0.65	0.472	0.551
8	1/2-14	0.82	0.551	0.689
10	5/8-14	0.90	0.630	0.760
12	3/4-14	1.04	0.630	0.902
16	1-11	1.30	0.748	1.130
20	1 1/4-11	1.64	0.787	1.449
24	1 1/2-11	1.87	0.866	1.681
32	2-11	2.34	0.984	2.150

Table I3 – Dimensions of BS B5200 60° Cone Connection (K4)

While the 60° cone versions of JIS and K4 fittings utilize the same BSPP threads and seat angle, not all dimensions are consistent. Therefore, they cannot be interchanged because the differences can cause leakage problems. An example of this is illustrated in Fig. I5, where a gap exists between sealing surfaces. The combination of matching proper components will create an effective seal as illustrated in Fig I6.

TABLE OF CONTENTS

VISUAL INDEX

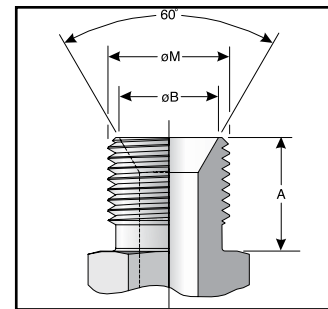


Fig. I3 – JIS B8363 60° Cone Connection (P4)

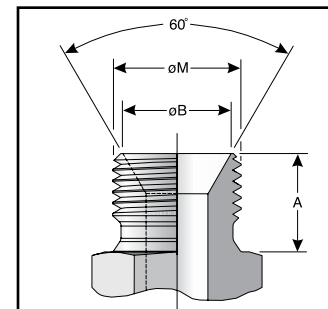


Fig. I4 – BS B5200 60° Cone Connection (K4)

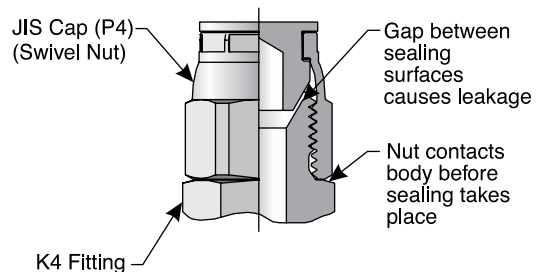


Fig. I5 – Illustration Showing Potential Leakage Problem When Mixing JIS and K4 Components

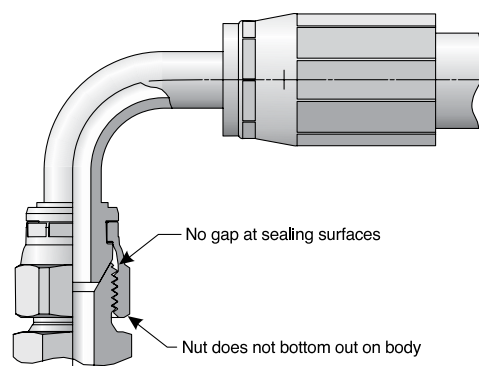
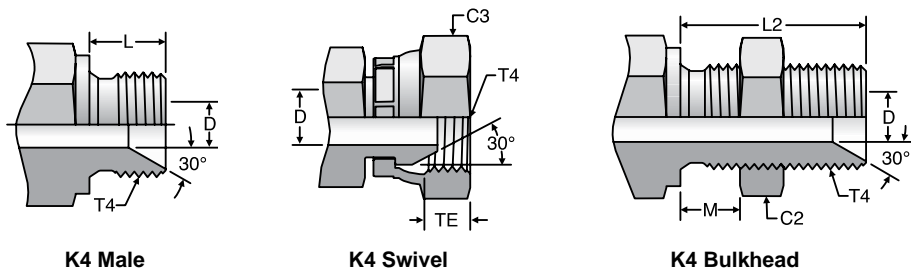


Fig. I6 – An Effective Seal Created with the Proper Combination of Components

Dimensions and pressures for reference only, subject to change.

K4 BSP Ends

TABLE OF CONTENTS
 VISUAL INDEX



	BSPB Thread	Bulkhead Nut Hex	Swivel Hex	Drill	Male Turn Back	Bulkhead Length	Max Bulkhead Thickness	Assembly Allowance
Dash Size	T4 BSPP	C2 (mm)	C3 (mm)	D (mm)	L (mm)	L2 (mm)	M (mm)	TE (mm)
2	1/8-28	—	14	3.5	8	—	—	—
4	1/4-19	19	19	4.7	11	28	9.5	7.3
6	3/8-19	22	22	7.9	12	32	12.5	8.4
8	1/2-14	27	27	11.1	14	35	12.3	9.3
10	5/8-14	30	30	14.3	16	35	10.7	—
12	3/4-14	36	32	16.7	16	38	13.3	11.3
16	1-11	41	41	22.2	19	41	10.0	13.6
20	1 1/4-11	50	50	28.6	20	44	12.0	—
24	1 1/2-11	55	60	33.3	22	48	14.0	—
32	2-11	—	—	46.0	25	—	—	—

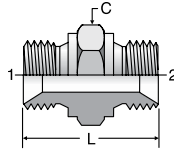
Dimensions and pressures for reference only, subject to change.



HMK4

Union
60° Cone / 60° Cone

Mates with 92, B1, B2 and B4 style hose fitting



WMK4WL4NM

Bulkhead Union
60° Cone / 60° Cone

Mates with 92, B1, B2 and B4 style hose fitting

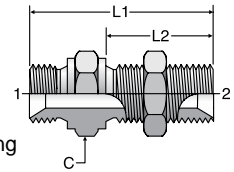


TABLE OF CONTENTS

VISUAL INDEX

TUBE FITTING PART #	END SIZE		C HEX (mm)	L (mm)	Dynamic Pressure (x 1,000 PSI)
	1 BSPP	2 BSPP			S
					2HMK4
4-2HMK4	1/4 - 19	1/8 - 28	19	28.0	5.1
4HMK4	1/4 - 19	1/4 - 19	19	31.5	5.1
6-4HMK4	3/8 - 19	1/4 - 19	22	33.2	2.9
6HMK4	3/8 - 19	3/8 - 19	22	34.7	2.9
8-4HMK4	1/2 - 14	1/4 - 19	27	36.7	2.9
8-6HMK4	1/2 - 14	3/8 - 19	27	38.2	2.9
8HMK4	1/2 - 14	1/2 - 14	27	40.7	2.9
10-8HMK4	5/8 - 14	1/2 - 14	30	43.2	2.9
10HMK4	5/8 - 14	5/8 - 14	30	45.2	2.9
12-4HMK4	3/4 - 14	1/4 - 19	32	39.2	2.9
12-6HMK4	3/4 - 14	3/8 - 19	32	40.7	2.9
12-8HMK4	3/4 - 14	1/2 - 14	32	43.2	2.9
12-10HMK4	3/4 - 14	5/8 - 14	32	45.2	2.9
12HMK4	3/4 - 14	3/4 - 14	32	45.2	2.9
16-8HMK4	1 - 11	1/2 - 14	41	46.9	1.7
16-10HMK4	1 - 11	5/8 - 14	41	48.9	1.7
16-12HMK4	1 - 11	3/4 - 14	41	48.9	1.7
16HMK4	1 - 11	1 - 11	41	51.9	1.7
20-12HMK4	1 1/4 - 11	3/4 - 14	50	57.4	1.5
20-16HMK4	1 1/4 - 11	1 - 11	50	60.4	1.5
20HMK4	1 1/4 - 11	1 1/4 - 11	50	61.4	1.5
24-16HMK4	1 1/2 - 11	1 - 11	55	64.4	1.5
24-20HMK4	1 1/2 - 11	1 1/4 - 11	55	65.4	1.5
24HMK4	1 1/2 - 11	1 1/2 - 11	55	67.4	1.5
32-24HMK4	2 - 11	1 1/2 - 11	70	72.9	1.0
32HMK4	2 - 11	2 - 11	70	76.4	1.0

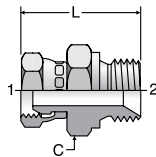
TUBE FITTING PART #	END SIZE		C HEX (mm)	L1 (mm)	L2 (mm)	Dynamic Pressure (x 1,000 PSI)
	1 & 2 BSPP	S				
		4WMK4WL4NM				1/4 - 19
6WMK4WL4NM	3/8 - 19	22	52.5	32	5.1	
8WMK4WL4NM	1/2 - 14	27	59.0	35	2.9	
10WMK4WL4NM	5/8 - 14	30	61.5	35	2.9	
12WMK4WL4NM	3/4 - 14	32	64.5	38	2.9	
16WMK4WL4NM	1 - 11	41	71.2	41	1.7	
20WMK4WL4NM	1 1/4 - 11	50	82.7	44	1.5	
24WMK4WL4NM	1 1/2 - 11	55	90.7	48	1.5	

Includes Bulkhead nut.

F6MK4

Swivel Nut Connector
60° Swivel / 60° Cone

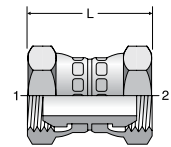
Mates with D9/92, B1, B2 and B4 style hose fitting



H6MK4

Swivel Nut Union
60° Swivel / 60° Swivel

Mates with D9 style hose fitting



TUBE FITTING PART #	END SIZE		C HEX (mm)	L (mm)	Dynamic Pressure (x 1,000 PSI)
	1 BSPP	2 BSPP			S
					4-4F6MK4
4-6F6MK4	1/4 - 19	3/8 - 19	22	38.5	5.1
4-8F6MK4	1/4 - 19	1/2 - 14	27	42.0	2.9
6-4F6MK4	3/8 - 19	1/4 - 19	22	38.3	5.1
6-6F6MK4	3/8 - 19	3/8 - 19	22	40.0	5.1
6-8F6MK4	3/8 - 19	1/2 - 14	27	43.6	2.9
8-6F6MK4	1/2 - 14	3/8 - 19	27	43.5	2.9
8-8F6MK4	1/2 - 14	1/2 - 14	27	46.1	2.9
8-12F6MK4	1/2 - 14	3/4 - 14	32	48.0	2.9
12-8F6MK4	3/4 - 14	1/2 - 14	32	48.6	2.9
12-12F6MK4	3/4 - 14	3/4 - 14	32	50.0	2.9
12-16F6MK4	3/4 - 14	1 - 11	41	54.3	1.7
16-16F6MK4	1 - 11	1 - 11	41	57.3	1.7

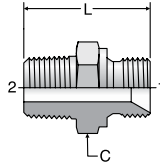
TUBE FITTING PART #	END SIZE		L (mm)	Dynamic Pressure (x 1,000 PSI)
	1 BSPP	2 BSPP		S
				4H6MK4
6-4H6MK4	3/8 - 19	1/4 - 19	38.6	5.1
6H6MK4	3/8 - 19	3/8 - 19	40.5	5.1
8-4H6MK4	1/2 - 14	1/4 - 19	41.5	2.9
8-6H6MK4	1/2 - 14	3/8 - 19	42.9	2.9
8H6MK4	1/2 - 14	1/2 - 14	45.8	2.9
10H6MK4	5/8 - 14	5/8 - 14	47.5	2.9
12-8H6MK4	3/4 - 14	1/2 - 14	48.2	2.9
12H6MK4	3/4 - 14	3/4 - 14	49.5	2.9
16H6MK4	1 - 11	1 - 11	57.5	1.7
20H6MK4	1 1/4 - 11	1 1/4 - 11	66.0	1.5
24H6MK4	1 1/2 - 11	1 1/2 - 11	70.0	1.5

Dimensions and pressures for reference only, subject to change.

FMK4

NPTF Male Connector
60° Cone / NPTF

Mates with 92, B1, B2 and B4 style hose fitting

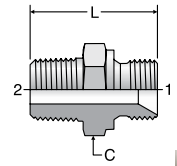


TUBE FITTING PART #	END SIZE		C HEX (mm)	L (mm)	Dynamic Pressure (x 1,000 PSI) S
	1 BSPP	2 NPTF			
2FMK4	1/8 - 28	1/8 - 27	14	24.4	5.1
2-4FMK4	1/8 - 28	1/4 - 18	19	28.9	5.1
4FMK4	1/4 - 19	1/8 - 18	19	28.9	5.1
4-4FMK4	1/4 - 19	1/4 - 18	19	33.4	5.1
4-6FMK4	1/4 - 19	3/8 - 18	19	33.6	5.1
6FMK4	3/8 - 19	1/4 - 18	22	35.1	5.1
6-6FMK4	3/8 - 19	3/8 - 18	22	35.1	5.1
6-8FMK4	3/8 - 19	1/2 - 14	22	39.9	5.1
8FMK4	1/2 - 14	3/8 - 18	27	38.6	2.9
8-8FMK4	1/2 - 14	1/2 - 14	27	43.4	2.9
8-12FMK4	1/2 - 14	3/4 - 14	27	43.9	2.9
12-8FMK4	3/4 - 14	1/2 - 14	32	45.9	2.9
12FMK4	3/4 - 14	3/4 - 14	32	45.9	2.9
12-16FMK4	3/4 - 14	1 - 11 1/2	36	50.8	2.9
16-12FMK4	1 - 11	3/4 - 14	41	49.6	1.7
16FMK4	1 - 11	1 - 11 1/2	41	54.5	1.7

F3MK4

BSPT Male Connector
60° Cone / BSPT

Mates with 92, B1, B2 and B4 style hose fitting

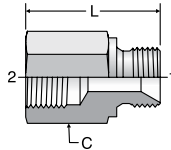


TUBE FITTING PART #	END SIZE		C HEX (mm)	L (mm)	Dynamic Pressure (x 1,000 PSI) S
	1 BSPP	2 BSPT			
2F3MK4	1/8 - 28	1/8 - 28	14	24.4	5.1
2-4F3MK4	1/8 - 28	1/4 - 19	14	28.9	5.1
4F3MK4	1/4 - 19	1/8 - 28	19	28.9	5.1
4-4F3MK4	1/4 - 19	1/4 - 19	19	33.4	5.1
4-6F3MK4	1/4 - 19	3/8 - 19	19	33.4	5.1
6F3MK4	3/8 - 19	1/4 - 19	22	35.1	5.1
6-6F3MK4	3/8 - 19	3/8 - 19	22	35.1	5.1
6-8F3MK4	3/8 - 19	1/2 - 14	22	39.9	2.9
8F3MK4	1/2 - 14	3/8 - 19	27	38.6	5.1
8-8F3MK4	1/2 - 14	1/2 - 14	22	43.4	2.9
10F3MK4	5/8 - 14	1/2 - 14	27	45.9	2.9
10-12F3MK4	5/8 - 14	3/4 - 14	30	45.9	2.9
12F3MK4	3/4 - 14	3/4 - 14	30	45.9	2.9
12-8F3MK4	3/4 - 14	1/2 - 14	32	46.0	1.7
12-16F3MK4	3/4 - 14	1 - 11	36	50.8	1.7
16F3MK4	1 - 11	1 - 11	41	54.5	1.7
16-12F3MK4	1 - 11	3/4 - 14	41	49.6	1.7
20F3MK4	1 1/4 - 11	1 1/4 - 11	50	63.7	1.5
24F3MK4	1 1/2 - 11	1 1/2 - 11	55	68.5	1.5

G4MK4

BSPP Female Connector
60° Cone / BSPP

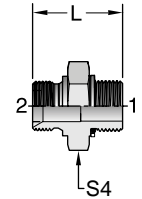
Mates with 92, B1, B2 and B4 style hose fitting



TUBE FITTING PART #	END SIZE		C HEX (mm)	L (mm)	Dynamic Pressure (x 1,000 PSI) S
	1 BSPP	2 BSPP			
6G4MK4	3/8 - 19	1/4 - 19	22	37.1	5.1
6-6G4MK4	3/8 - 19	3/8 - 19	23	36.9	1.7
8-4G4MK4	1/2 - 14	1/4 - 19	27	38.0	2.9
8G4MK4	1/2 - 14	3/8 - 19	30	45.3	2.9
12-4G4MK4	3/4 - 14	1/4 - 19	32	40.0	2.9
12-6G4MK4	3/4 - 14	3/8 - 19	32	41.6	2.9
12-8G4MK4	3/4 - 14	1/2 - 14	32	47.3	2.9
16-4G4MK4	1 - 11	1/4 - 19	41	43.0	1.7
16-6G4MK4	1 - 11	3/8 - 19	41	44.6	1.7
16-8G4MK4	1 - 11	1/2 - 14	41	50.3	1.7
16-12G4MK4	1 - 11	3/4 - 14	41	52.2	1.7

K4HF80

Metric Male Connector
BSP 60° Cone / Metric-ORR
(for ISO 9974 / DIN 3852-1 Port)



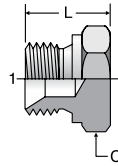
TUBE FITTING PART #	End Size		S4 Hex (mm)	L (mm)	Dynamic Pressure (x 1,000 PSI) S
	1 BSPP	2 Metric Str			
2M10K4HF80	1/8-28	M10X1	17	25.7	5.1
4M12K4HF80	1/4-19	M12X1.5	19	30.1	5.1
4M14K4HF80	1/4-19	M14X1.5	19	30.1	5.1
6M16K4HF80	3/8-19	M16X1.5	22	32.6	5.1
8M16K4HF80	1/2-14	M16X1.5	27	34.6	2.9
6M18K4HF80	3/8-19	M18X1.5	27	34.1	2.9
8M18K4HF80	1/2-14	M18X1.5	27	33.1	2.9
8M22K4HF80	1/2-14	M22X1.5	32	40.4	2.9
12M27K4HF80	3/4-14	M27X2	41	47.9	2.9
16M33K4HF80	1-11	M33X2	41	56.7	1.7

Dimensions and pressures for reference only, subject to change.

PNMK4

Hex Plug
60° Cone

Mates with 92, B1, B2 and B4 style hose fitting

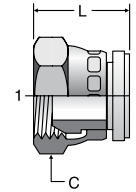


TUBE FITTING PART #	END SIZE		C HEX (mm)	L (mm)	Dynamic Pressure (x 1,000 PSI)
	1 BSPP	S			
					2PNMK4
4PNMK4	1/4 - 19	19	18.8	5.1	
6PNMK4	3/8 - 19	22	20.5	5.1	
8PNMK4	1/2 - 14	27	24.0	2.9	
10PNMK4	5/8 - 14	30	24.0	2.9	
12PNMK4	3/4 - 14	32	26.5	2.9	
16PNMK4	1 - 11	41	30.2	1.7	
20PNMK4	1 1/4 - 11	50	38.7	1.5	
24PNMK4	1 1/2 - 11	55	42.7	1.5	
32PNMK4	2 - 11	70	48.2	1.0	

FNMK4

Cap
60° Cone

Mates with D9 style hose fitting



TUBE FITTING PART #	END SIZE		C HEX (mm)	L (mm)	Dynamic Pressure (x 1,000 PSI)
	1 BSPP	S			
					2FNMK4
4FNMK4	1/4 - 19	19	20.6	5.1	
6FNMK4	3/8 - 19	22	22.3	5.1	
8FNMK4	1/2 - 14	27	22.7	2.9	
10FNMK4	5/8 - 14	30	26.6	2.9	
12FNMK4	3/4 - 14	32	28.0	2.9	
16FNMK4	1 - 11	41	31.6	1.7	
20FNMK4	1 1/4 - 11	50	35.9	1.5	
24FNMK4	1 1/2 - 11	60	37.9	1.5	

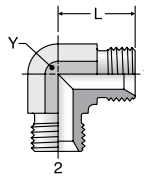
TABLE OF CONTENTS

VISUAL INDEX

EMK4

Union Elbow
60° Cone / 60° Cone

Mates with D9/92, B1, B2 and B4 style hose fitting

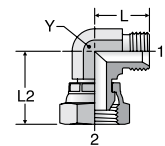


TUBE FITTING PART #	END SIZE		L (mm)	Y (mm)	Dynamic Pressure (x 1,000 PSI)
	1 BSPP	2 BSPP			S
4EMK4	1/4 - 19	1/4 - 19	27.8	14	5.1
6EMK4	3/8 - 19	3/8 - 19	31.7	19	5.1
8EMK4	1/2 - 14	1/2 - 14	37.0	22	2.9
10EMK4	5/8 - 14	5/8 - 14	39.0	22	2.9
12EMK4	3/4 - 14	3/4 - 14	41.6	27	2.9
16EMK4	1 - 11	1 - 11	49.7	23	1.7
20EMK4	1 1/4 - 11	1 1/4 - 11	54.4	41	1.5
24EMK4	1 1/2 - 11	1 1/2 - 11	53.7	48	1.5

C6MK4

Swivel Nut Elbow
60° Cone / 60° Swivel

Mates with D9/92, B1, B2 and B4 style hose fitting



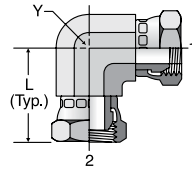
TUBE FITTING PART #	END SIZE		L (mm)	L2 (mm)	Y (mm)	Dynamic Pressure (x 1,000 PSI)
	1 BSPP	2 BSPP				S
4C6MK4	1/4 - 19	1/4 - 19	27.8	31.2	19	5.1
6C6MK4	3/8 - 19	3/8 - 19	31.7	36.2	22	5.1
8C6MK4	1/2 - 14	1/2 - 14	37.0	41.0	27	2.9
10C6MK4	5/8 - 14	5/8 - 14	39.0	41.6	27	2.9
12C6MK4	3/4 - 14	3/4 - 14	41.6	45.3	33	2.9
16C6MK4	1 - 11	1 - 11	49.7	53.9	41	1.7
20C6MK4	1 1/4 - 11	1 1/4 - 11	54.4	60.0	48	1.5
24C6MK4	1 1/2 - 11	1 1/2 - 11	53.7	63.3	48	1.5

Dimensions and pressures for reference only, subject to change.

E6MK4

Swivel Nut Union Elbow
60° Swivel / 60° Swivel

Mates with D9 style hose fitting

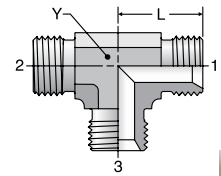


TUBE FITTING PART #	END SIZE		L (mm)	Y (mm)	Dynamic Pressure (x 1,000 PSI)
	1 BSPP	2 BSPP			S
4E6MK4	1/4 - 19	1/4 - 19	30.5	14	5.1
6E6MK4	3/8 - 19	3/8 - 19	33.0	19	5.1
8E6MK4	1/2 - 14	1/2 - 14	38.8	22	2.9
10E6MK4	5/8 - 14	5/8 - 14	39.4	22	2.9
12E6MK4	3/4 - 14	3/4 - 14	42.3	27	2.9
16E6MK4	1 - 11	1 - 11	49.0	33	1.7
20E6MK4	1 1/4 - 11	1 1/4 - 11	58.2	41	1.5
24E6MK4	1 1/2 - 11	1 1/2 - 11	63.3	48	1.5

JMK4

Union Tee
60° Cone (all three ends)

Mates with 92, B1, B2 and B4 style hose fitting



TUBE FITTING PART #	END SIZE			L (mm)	Y (mm)	Dynamic Pressure (x 1,000 PSI)
	1 BSPP	2 BSPP	3 BSPP			S
2JMK4	1/8 - 28	1/8 - 28	1/8 - 28	16.6	11	5.1
4JMK4	1/4 - 19	1/4 - 19	1/4 - 19	27.8	19	5.1
6JMK4	3/8 - 19	3/8 - 19	3/8 - 19	31.7	22	5.1
8JMK4	1/2 - 14	1/2 - 14	1/2 - 14	37.0	27	2.9
10JMK4	5/8 - 14	5/8 - 14	5/8 - 14	39.0	27	2.9
12JMK4	3/4 - 14	3/4 - 14	3/4 - 14	41.9	33	2.9
16JMK4	1 - 11	1 - 11	1 - 11	49.7	41	1.7
20JMK4	1 1/4 - 11	1 1/4 - 11	1 1/4 - 11	54.4	48	1.5
24JMK4	1 1/2 - 11	1 1/2 - 11	1 1/2 - 11	53.7	48	1.5

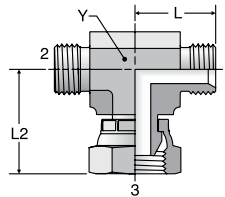
TABLE OF CONTENTS

VISUAL INDEX

S6MK4

Swivel Nut Branch Tee
60° Cone / 60° Cone / 60° Swivel

Mates with D9/92, B1, B2 and B4 style hose fitting

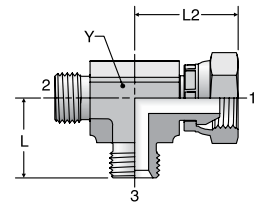


TUBE FITTING PART #	END SIZE			L (mm)	L2 (mm)	Y (mm)	Dynamic Pressure (x 1,000 PSI)
	1 BSPP	2 BSPP	3 BSPP				S
2S6MK4	1/8 - 28	1/8 - 28	1/8 - 28	16.6	22.0	11	5.1
4S6MK4	1/4 - 19	1/4 - 19	1/4 - 19	27.8	31.2	19	5.1
6S6MK4	3/8 - 19	3/8 - 19	3/8 - 19	31.7	36.2	27	5.1
8S6MK4	1/2 - 14	1/2 - 14	1/2 - 14	37.0	41.0	27	2.9
10S6MK4	5/8 - 14	5/8 - 14	5/8 - 14	39.0	41.6	27	2.9
12S6MK4	3/4 - 14	3/4 - 14	3/4 - 14	41.6	45.3	33	2.9
16S6MK4	1 - 11	1 - 11	1 - 11	49.7	53.9	41	1.8
20S6MK4	1 1/4 - 11	1 1/4 - 11	1 1/4 - 11	54.4	60.0	48	1.5

R6MK4

Swivel Nut Run Tee
60° Swivel / 60° Cone / 60° Cone

Mates with D9/92, B1, B2 and B4 style hose fitting



TUBE FITTING PART #	END SIZE			L (mm)	L2 (mm)	Y (mm)	Dynamic Pressure (x 1,000 PSI)
	1 BSPP	2 BSPP	3 BSPP				S
2R6MK4	1/8 - 28	1/8 - 28	1/8 - 28	16.6	22.0	11	5.1
4R6MK4	1/4 - 19	1/4 - 19	1/4 - 19	27.8	31.2	19	5.1
6R6MK4	3/8 - 19	3/8 - 19	3/8 - 19	31.7	36.2	27	5.1
8R6MK4	1/2 - 14	1/2 - 14	1/2 - 14	37.0	41.0	27	2.9
10R6MK4	5/8 - 14	5/8 - 14	5/8 - 14	39.0	41.6	27	2.9
12R6MK4	3/4 - 14	3/4 - 14	3/4 - 14	41.6	45.3	33	2.9
16R6MK4	1 - 11	1 - 11	1 - 11	49.7	53.9	41	1.8
20R6MK4	1 1/4 - 11	1 1/4 - 11	1 1/4 - 11	54.4	60.0	48	1.5

Dimensions and pressures for reference only, subject to change.

J6MK4

Swivel Nut Union Tee
 60° Swivel (all three ends)

Mates with D9 style hose fitting

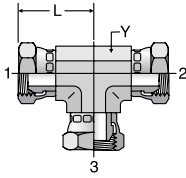


TABLE
 OF
 CONTENTS

VISUAL
 INDEX

TUBE FITTING PART #	END SIZE			L (TYP.) (mm)	Y (mm)	Dynamic Pressure (x 1,000 PSI)
	1 BSPP	2 BSPP	3 BSPP			S
4J6MK4	1/4 - 19	1/4 - 19	1/4 - 19	30.5	14	5.1
6J6MK4	3/8 - 19	3/8 - 19	3/8 - 19	33.0	19	5.1
8J6MK4	1/2 - 14	1/2 - 14	1/2 - 14	38.8	22	2.9
10J6MK4	5/8 - 14	5/8 - 14	5/8 - 14	39.4	22	2.9
12J6MK4	3/4 - 14	3/4 - 14	3/4 - 14	42.3	27	2.9
16J6MK4	1 - 11	1 - 11	1 - 11	49.0	33	1.7
20J6MK4	1 1/4 - 11	1 1/4 - 11	1 1/4 - 11	58.2	41	1.5

Dimensions and pressures for reference only, subject to change.

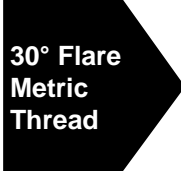




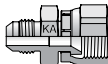
TABLE
OF
CONTENTS

VISUAL
INDEX



Komatsu® Style Adapters

J

 <p>30° Flare Metric Thread</p>	<p>PNMKA Plug</p> 	<p>FNMKA Cap</p> 	<p>HMKA Union</p> 	<p>XHMKA 37° Flare / 30° Flare</p> 	<p>XHMKA6 37° Flare / 30° Swivel</p> 
	J5	J5	J5	J5	J5

**TABLE
OF
CONTENTS**

Dimensions and pressures for reference only, subject to change.

Komatsu Style Adapters

The 30° flare, metric thread interface, also known as the Komatsu style flare fitting, is one of the most common specialized OEM mobile equipment fittings in the marketplace. Parker offers a line of caps, plugs and conversion adapters to mate with this specialty connection. Parker's line of products is designated as "KA" adapters.

The Komatsu style connection is generally rated at 4000 psi (280 kg/cm² or 27.5 Mpa). Parker's caps, plugs and conversion adapters are rated at the full pressure rating in sizes 4-16, with slight pressure reductions in the less common sizes of -20 and -24.

Parker's offering of Komatsu style adapters allow for more aftermarket flexibility. Parker's caps and plugs enable technicians to protect critical sealing surfaces of hoses and adapters from damage and contamination. This protection is important during testing, repair and/or implement installation and removal.

Parker's line of Komatsu style conversion adapters are ideal for emergency situations, field repair, or "plumbing in" hydraulic attachments and options. Parker's exclusive swivel nut design minimizes the sealing surface damage to mating components.

Design and Construction

Parker's line of Komatsu style fitting is sold only as a hose adapter and thus tube nuts and sleeves are not available. The adapter consists of a single body. The mating hose swivel mates directly to the 30° nose of the adapter, as shown in Fig. J1. This simple, metal-to-metal connection provides a very effective seal between the fitting nose and the hose swivel seat.

The Komatsu style adapter offers the traditional advantages of the 37° flare fitting but incorporates the following differences:

- 1) 30° nose flare
- 2) Metric threads with 1.5 mm pitch
- 3) Used only as a hose adapter
- 4) Heavy duty crimp nut for higher assembly torques

Due to the prevalent field repair needs of mobile equipment and relative simplicity of the Komatsu style fitting, several manufacturers offer a similar product line. Even though some manufacturers conform to the same dimensional standards, there are significant performance advantages to Parker's product offering due to higher integrity manufacturing methods and Parker's commitment to quality.

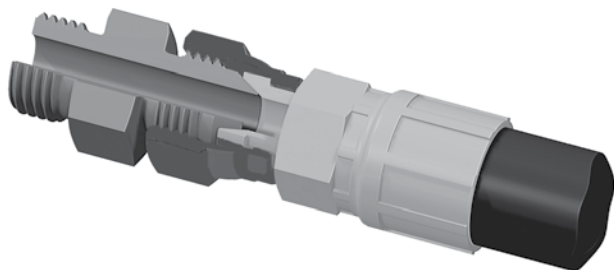


Fig. J1 – Cutaway of Komatsu Style Adapter

Product Specifications

Komatsu style fittings are offered in eight common sizes. See Table J1 below, which shows the Komatsu nominal size and the equivalent Parker TFD Dash Size. The table also shows the equivalent Parker Hose Products / Parflex Division mating hose series.

Komatsu Nominal Size	Parker TFD Equivalent Dash Size	Komatsu Thread	Parker Hose Fitting Mating Series
02	-4	M14 x 1.5	MU
03	-6	M18 x 1.5	MU
04	-8	M22 x 1.5	MU
05	-10	M24 x 1.5	XU
06	-12	M30 x 1.5	XU
10	-16	M33 x 1.5	XU
12	-20	M36 x 1.5	XU
14	-24	M42 x 1.5	XU

Table J1 – Parker equivalent dash sizes and mating hose series for Komatsu Style Fittings

Reference Locations

Dynamic Pressure Ratings: Please refer to the last column of the part number tables located on the following pages of this section for the appropriate dynamic pressure ratings.

Standard Material Specifications: Please refer to Table U1 located in the Appendix Section.

TABLE OF CONTENTS

VISUAL INDEX

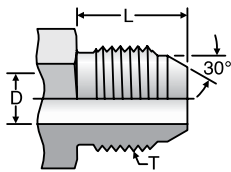
J

Dimensions and pressures for reference only, subject to change.

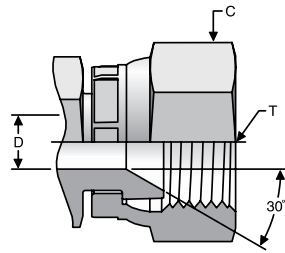
Komatsu Ends

TABLE
 OF
 CONTENTS

VISUAL
 INDEX



**Komatsu Male,
 30° Flare**



Komatsu Swivel

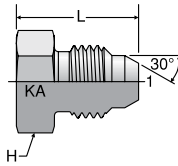
	Metric Thread	Hex	Drill	Male Turn Back
Dash Size	T Metric	C (mm)	D (mm)	L (mm)
4	M14x1.5	19	5	17.0
6	M18x1.5	24	8	18.0
8	M22x1.5	27	10	20.0
10	M24x1.5	32	13	33.0
12	M30x1.5	36	14	26.0
16	M33x1.5	41	19	30.0

Dimensions and pressures for reference only, subject to change.

PNMKA

Plug
30° Flare

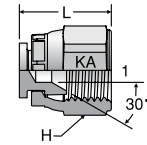
Mates with XU and MU series hose fittings



TUBE FITTING PART #	END SIZE		H HEX (mm)	L (mm)	Dynamic Pressure (x 1,000 PSI) S
	1 Metric Thread				
4PNMKA	M14 X 1.5		17	23.4	4.0
6PNMKA	M18 X 1.5		22	25.1	4.0
8PNMKA	M22 X 1.5		24	28.7	4.0
10PNMKA	M24 X 1.5		27	32.0	4.0
12PNMKA	M30 X 1.5		32	36.6	4.0
16PNMKA	M33 X 1.5		38	40.6	4.0

FNMKA

Cap
30° Flare



TUBE FITTING PART #	END SIZE		H HEX (mm)	L (mm)	Dynamic Pressure (x 1,000 PSI) S
	1 Metric Thread				
4FNMKA	M14 X 1.5		19	21.4	4.0
6FNMKA	M18 X 1.5		24	23.1	4.0
8FNMKA	M22 X 1.5		27	27.1	4.0
10FNMKA	M24 X 1.5		32	31.8	4.0
12FNMKA	M30 X 1.5		36	35.5	4.0
16FNMKA	M33 X 1.5		41	40.9	4.0

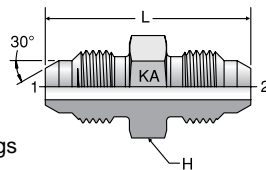
TABLE OF CONTENTS

VISUAL INDEX

HMKA

Male Union
30° Flare

Mates with XU and MU series hose fittings

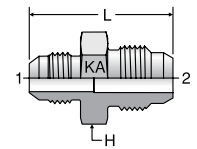


TUBE FITTING PART #	END SIZE		H HEX (mm)	L (mm)	Dynamic Pressure (x 1,000 PSI) S
	1&2 Metric Thread				
4-4HMKA	M14 X 1.5		17	39.4	4.0
6-6HMKA	M18 X 1.5		22	43.4	4.0
8-8HMKA	M22 X 1.5		24	47.5	4.0
10-10HMKA	M24 X 1.5		27	52.1	4.0
12-12HMKA	M30 X 1.5		32	63.2	4.0
16-16HMKA	M33 X 1.5		38	72.1	4.0

XHMKA

37° Conversion Adapter
30° Flare / 37° Flare

End 2 mates with XU and MU series hose fittings

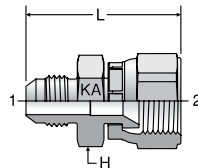


TUBE FITTING PART #	END SIZE		H HEX (mm)	L (mm)	Dynamic Pressure (x 1,000 PSI) S
	1 (in.)	2 Metric Thread			
4-4XHMKA	1/4	M14 X 1.5	17	37.1	4.0
6-6XHMKA	3/8	M18 X 1.5	22	39.6	4.0
8-8XHMKA	1/2	M22 X 1.5	24	44.2	4.0
10-10XHMKA	5/8	M24 X 1.5	27	49.8	4.0
12-12XHMKA	3/4	M30 X 1.5	32	59.2	4.0
16-16XHMKA	1	M33 X 1.5	38	65.3	4.0

J

XHMKA6

37° Swivel Conversion Adapter
37° Flare / 30° Swivel



TUBE FITTING PART #	END SIZE		H HEX (mm)	L (mm)	Dynamic Pressure (x 1,000 PSI) S
	1 (in.)	2 Metric Thread			
4-4XHMKA6	1/4	M14 X 1.5	17	40.6	4.0
6-6XHMKA6	3/8	M18 X 1.5	22	42.7	4.0
8-8XHMKA6	1/2	M22 X 1.5	24	49.0	4.0
10-10XHMKA6	5/8	M24 X 1.5	27	57.4	4.0
12-12XHMKA6	3/4	M30 X 1.5	32	65.8	4.0
16-16XHMKA6	1	M33 X 1.5	38	73.9	4.0

Dimensions and pressures for reference only, subject to change.

TABLE
OF
CONTENTS

VISUAL
INDEX

Dimensions and pressures for reference only, subject to change.



TABLE
OF
CONTENTS

VISUAL
INDEX




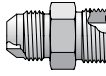
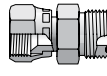
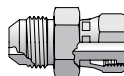
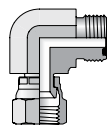

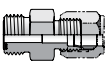

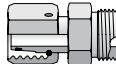







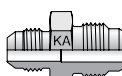
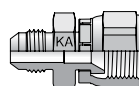
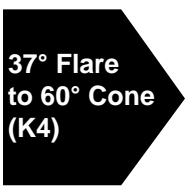

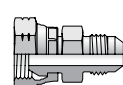
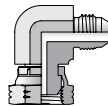


Conversion Adapters

K

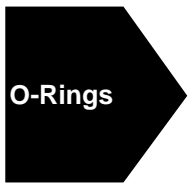




ENGINEERING YOUR SUCCESS.

TABLE
 OF
 CONTENTS

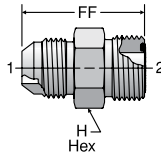
	<p>XHLO 37° Flare / ORFS</p>  <p>K3</p>	<p>LOHX6 37° Swivel / ORFS</p>  <p>K3</p>	<p>XHL6 37° Flare / ORFS Swivel</p>  <p>K3</p>	<p>LOEX6 ORFS / 37° Flare Swivel</p>  <p>K3</p>	
	<p>BUHLO ORFS / 24° Flareless</p>  <p>K4</p>		<p>LOHU86 Metric 24° Flareless/ORFS</p>  <p>K4</p>		
	<p>XHBU 37° Flare / Flareless</p>  <p>K4</p>	<p>XHBU2 37° / Flareless Bulkhead</p>  <p>K4</p>		<p>XHT46 37° Flare / 30° Flare</p>  <p>K5</p>	<p>XHT4 37° Flare / JIS 30° Flare</p>  <p>K5</p>
	<p>XHMKA 37° Flare / 30° Flare</p>  <p>J5</p>	<p>XHMKA6 37° Flare / 30° Swivel</p>  <p>J5</p>			
	<p>XHK4 37° Flare / 60° Cone</p>  <p>K5</p>	<p>XHMK46 37° Flare / BSPP Swivel</p>  <p>K5</p>	<p>XEMK46 37° Flare / BSPP Swivel</p>  <p>K6</p>		<p>XHU86 37° / Metric 24° Flareless</p>  <p>K6</p>

O-Rings and Seals (Shown in Section N)

	<p>ORFS O-Ring</p>  <p>N4</p>	<p>EO O-Ring</p>  <p>N10</p>
---	---	--

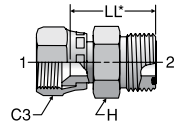
XHLO

Male Adapter
37° Flare / ORFS



LOHX6

Swivel Adapter
37° Flare Swivel / ORFS



*LL – End to base of flare

TABLE OF CONTENTS

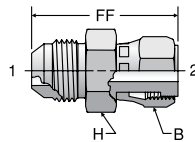
VISUAL INDEX

TUBE FITTING PART #	END SIZE		FF (in.)	H HEX (in.)	Dynamic Pressure (x 1,000 PSI)	
	1 (in.)	2 (in.)			-S	-SS
	4 XHLO	1/4			1/4	1.25
6 XHLO	3/8	3/8	1.34	3/4	6.0	7.2
8 XHLO	1/2	1/2	1.55	7/8	6.0	7.2
10 XHLO	5/8	5/8	1.83	1 1/16	5.0	6.0
12 XHLO	3/4	3/4	2.05	1 1/4	5.0	6.0
16 XHLO	1	1	2.16	1 1/2	4.5	5.4
20 XHLO	1 1/4	1 1/4	2.29	1 3/4	4.0	4.8
24 XHLO	1 1/2	1 1/2	2.48	2 1/8	3.0	3.6

TUBE FITTING PART #	END SIZE		C3 HEX (in.)	H HEX (in.)	LL Ref. (in.)	Dynamic Pressure (x 1,000 PSI)	
	1 (in.)	2 (in.)				-S	-SS
	4 LOHX6	1/4				1/4	9/16
6 LOHX6	3/8	3/8	11/16	3/4	1.06	5.0	6.0
8 LOHX6	1/2	1/2	7/8	7/8	1.21	5.0	6.0
10 LOHX6	5/8	5/8	1	1 1/16	1.40	5.0	6.0
12 LOHX6	3/4	3/4	1 1/4	1 1/4	1.48	5.0	6.0
16 LOHX6	1	1	1 1/2	1 1/2	1.64	3.6	4.3
20 LOHX6	1 1/4	1 1/4	2	1 3/4	1.77	3.6	4.3

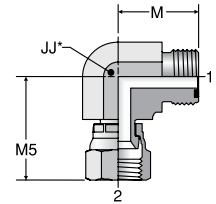
XHL6

Male Swivel Adapter
ORFS Swivel / 37° Flare



LOEX6

Swivel Elbow
ORFS / 37° Flare Swivel



* JJ – Across wrench flats

TUBE FITTING PART #	END SIZE		B HEX (in.)	FF (in.)	H HEX (inch) (in.)	Dynamic Pressure (x 1,000 PSI)	
	1 (in.)	2 (in.)				-S	-SS
	4 XHL6	1/4				1/4	11/16
6 XHL6	3/8	3/8	13/16	1.61	3/4	6.0	7.2
8 XHL6	1/2	1/2	15/16	1.90	7/8	6.0	7.2
10 XHL6	5/8	5/8	1 1/8	2.20	1 1/16	5.0	6.0
12 XHL6	3/4	3/4	1 3/8	2.50	1 1/4	5.0	6.0
16 XHL6	1	1	1 5/8	2.66	1 1/2	4.5	5.4
20 XHL6	1 1/4	1 1/4	1 7/8	2.80	1 11/16	4.0	4.8

TUBE FITTING PART #	END SIZE		JJ (in.)	M (in.)	M5 (in.)	Dynamic Pressure (x 1,000 PSI)	
	1 (in.)	2 UN/UNF-2B				-S	-SS
	4 LOEX6	1/4				1/4	9/16
6 LOEX6	3/8	3/8	3/4	0.98	1.25	5.0	5.0
8 LOEX6	1/2	1/2	3/4	1.10	1.38	5.0	5.0
10 LOEX6	5/8	5/8	1 1/16	1.31	1.63	5.0	5.0
12 LOEX6	3/4	3/4	1 3/16	1.47	1.80	5.0	5.0
16 LOEX6	1	1	1 7/16	1.64	2.00	4.0	4.0
20 LOEX6	1 1/4	1 1/4	1 5/8	1.76	2.31	3.6	3.6
24 LOEX6	1 1/2	1 1/2	1 7/8	1.92	2.59	3.0	3.0

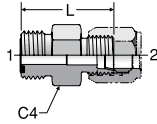
Dimensions and pressures for reference only, subject to change.



K

BUHLO

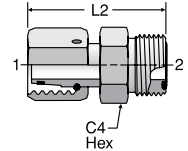
Ferulok Male Adapter
ORFS / SAE Flareless



TUBE FITTING PART #	END SIZE		C4 HEX (in.)	L (in.)	Dynamic Pressure (x 1,000 PSI)	
	1 (in.)	2 (in.)			-S	-SS
	6 BUHLO	3/8			3/8	3/4
8 BUHLO	1/2	1/2	7/8	1.45	5.0	6.0
10 BUHLO	5/8	5/8	1 1/16	1.70	5.0	6.0
12 BUHLO	3/4	3/4	1 1/4	1.88	4.5	5.4
16 BUHLO	1	1	1 1/2	1.94	4.0	4.8

LOHU86

EO Swivel Adapter
24° Flareless Metric Swivel (EO) / ORFS



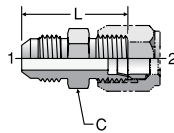
TUBE FITTING PART #	END SIZE		C4 HEX (in.)	L2 (in.)	Dynamic Pressure (x 1,000 PSI)	
	1 EO Swivel	2 (in.)			-S	-SS
	L Series					
4 -6L LOHU86	6L	1/4	5/8	1.32	4.5	5.4
4-8L LOHU86	8L	1/4	5/8	1.32	4.5	5.4
6-10L LOHU86	10L	3/8	3/4	1.44	4.5	5.4
8-12L LOHU86	12L	1/2	7/8	1.53	4.5	5.4
10-15L LOHU86	15L	5/8	1 1/16	1.82	4.5	5.4
12-18L LOHU86	18L	3/4	1 1/4	1.89	4.5	5.4
16-22L LOHU86	22L	1	1 1/2	2.08	2.5	3.0
S Series						
4-6S LOHU86	6S	1/4	5/8	1.32	9.2	9.2
4-8S LOHU86	8S	1/4	5/8	1.34	9.2	9.2
6-10S LOHU86	10S	3/8	3/4	1.44	9.2	9.2
8-12S LOHU86	12S	1/2	7/8	1.59	9.2	9.2
10-14S LOHU86	14S	5/8	1 1/16	1.84	9.2	9.2
10-16S LOHU86	16S	5/8	1 1/16	1.84	5.8	5.8
12-20S LOHU86	20S	3/4	1 1/4	2.05	5.8	5.8
16-25S LOHU86	25S	1	1 1/2	2.15	5.8	5.8

TABLE OF CONTENTS

VISUAL INDEX

XHBU

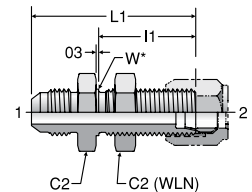
Union Adapter
SAE Flareless / 37° Flare



TUBE FITTING PART #	END SIZE		C HEX (in.)	L (in.)	Dynamic Pressure (x 1,000 PSI)	
	1 (in.)	2 (in.)			-S	-SS
	4 XHBU	1/4			1/4	1/2
6 XHBU	3/8	3/8	5/8	1.28	5.0	7.7
8 XHBU	1/2	1/2	13/16	1.47	5.0	7.7
10 XHBU	5/8	5/8	15/16	1.69	5.0	6.0
12 XHBU	3/4	3/4	1 1/8	1.94	4.5	6.0
16 XHBU	1	1	1 5/8	1.97	4.0	4.8
20 XHBU	1 1/4	1 1/4	1 3/4	2.00	3.0	3.6
24 XHBU	1 1/2	1 1/2	2 1/8	2.16	2.0	2.4

XHBU2

Bulkhead Union Adapter
SAE Flareless Bulkhead / 37° Flare



*W – Bulkhead pilot dia. recommended clearance hole is +.015 over W dia.

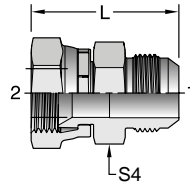
TUBE FITTING PART #	END SIZE		C2 HEX (in.)	I1 (in.)	L1 (in.)	W (in.)	Max. Bulkhead Thickness	Dynamic Pressure (x 1,000 PSI)	
	1 (in.)	2 (in.)						-S	-SS
	4 XHBU2	1/4						1/4	11/16
6 XHBU2	3/8	3/8	13/16	1.17	2.08	0.56	0.40	5.0	7.7
8 XHBU2	1/2	1/2	1	1.31	2.31	0.75	0.40	5.0	7.7
10 XHBU2	5/8	5/8	1 1/8	1.45	2.56	0.88	0.37	5.0	7.7
12 XHBU2	3/4	3/4	1 3/8	1.56	2.94	1.06	0.43	4.5	5.4
16 XHBU2	1	1	1 5/8	1.56	2.95	1.31	0.43	4.0	4.8

Dimensions and pressures for reference only, subject to change.



XHT46

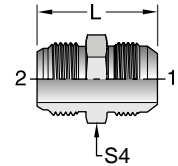
BSPP Swivel Adapter
37° Flare / 30° Flare Swivel



TUBE FITTING PART #	End Size		S4 Hex (in.)	L (in.)	Dynamic Pressure (x 1,000 PSI)	
	1 (in.)	2 BSPP			-S	
4 XHT46	1/4	1/4-19	9/16	1.22	5.0	
6 XHT46	3/8	3/8-19	11/16	1.32	5.0	
8 XHT46	1/2	1/2-14	7/8	1.46	5.0	
12 XHT46	3/4	3/4-14	1 1/4	1.92	4.0	
16 XHT46	1	1-11	1 1/2	2.05	3.0	

XHT4

Union Adapter
37° Flare / JIS 30° Flare



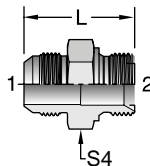
TUBE FITTING PART #	End Size		S4 Hex (in.)	L (in.)	Dynamic Pressure (x 1,000 PSI)	
	1 (in.)	2 BSPP			-S	
4-4 XHT4	1/4	1/4-19	3/4	1.42	5.0	
6 XHT4	3/8	3/8-19	3/4	1.55	5.0	
8 XHT4	1/2	1/2-14	7/8	1.75	5.0	
12 XHT4	3/4	3/4-14	1 1/8	2.06	4.0	
16 XHT4	1	1-11	1 3/8	2.17	3.0	

TABLE OF CONTENTS

VISUAL INDEX

XHK4

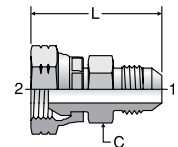
BSPP Swivel Adapter
37° Flare / 60° Cone



TUBE FITTING PART #	End Size		S4 Hex (in.)	L (in.)	Dynamic Pressure (x 1,000 PSI)	
	1 (in.)	2 BSPP			-S	
4-4 XHK4	1/4	1/4-19	3/4	1.25	5.1	
6-4 XHK4	3/8	1/4-19	7/8	1.42	2.9	
6-6 XHK4	3/8	3/8-19	7/8	1.46	2.9	
8-6 XHK4	1/2	3/8-19	1 1/16	1.61	2.9	
8-8 XHK4	1/2	1/2-14	1 1/16	1.69	2.9	
10-8 XHK4	5/8	1/2-14	1 1/8	1.89	2.9	
12-12 XHK4	3/4	3/4-14	1 5/16	2.13	2.9	
12-16XHK4	3/4	1-11	1 5/8	2.27	1.7	
16-16 XHK4	1	1-11	1 5/8	2.32	1.7	

XHMK46

BSPP Swivel Adapter
37° Flare / BSPP 60° Cone Swivel



Swivel end mates with BS5200 (Parker K4) adapters and Parker D9 hose fittings.

TUBE FITTING PART #	END SIZE		C HEX (mm)	L (mm)	Dynamic Pressure (x 1,000 PSI)	
	1 (in.)	2 BSPP			S	
6-4XHMK46	3/8	1/4-19	17	40.0	5.0	
6XHMK46	3/8	3/8-19	17	39.2	4.0	
8-6XHMK46	1/2	3/8-19	19	42.3	4.0	
8XHMK46	1/2	1/2-14	19	45.0	4.0	
10-8XHMK46	5/8	1/2-14	24	48.6	4.0	
12XHMK46	3/4	3/4-14	30	50.0	4.0	
12-16XHMK46	3/4	1-11	36	56.8	3.0	
16XHMK46	1	1-11	36	58.0	3.0	

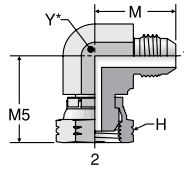
K

Dimensions and pressures for reference only, subject to change.



XEMK46

90° BSP Swivel Adapter
37° Flare / BSPP 60° Cone
Swivel



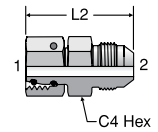
* Y – Across wrench flats

Swivel end mates with BS5200 (Parker K4) adapters and Parker D9 hose fittings.

TUBE FITTING PART #	END SIZE		M (mm)	M5 (mm)	Y (mm)	Dynamic Pressure (x 1,000 PSI)		
	1 (in.)	2 BSPP				S		
	6-4XEMK46	3/8				1/4-19	26.9	33.2
6XEMK46	3/8	3/8-19	26.9	32.6	19	4.0		
8-6XEMK46	1/2	3/8-19	31.8	32.6	19	4.0		
8XEMK46	1/2	1/2-14	31.8	38.8	22	4.0		
10-8XEMK46	5/8	1/2-14	36.8	38.8	22	4.0		
12XEMK46	3/4	3/4-14	42.2	40.3	27	4.0		
12-16XEMK46	3/4	1-11	42.2	48.8	33	3.0		
16XEMK46	1	1-11	46.0	48.8	33	3.0		

XHU86

EO Swivel Adapter
Metric Swivel (EO) / 37° Flare



TUBE FITTING PART #	END SIZE		C4 HEX (in.)	L2 (in.)	Dynamic Pressure (x 1,000 PSI)		
	1 EO Swivel	2 (in.)			S SS B		
	L Series						
4-6L XHU86	6L	1/4	1/2	1.47	4.5	4.5	2.9
6-8L XHU86	8L	3/8	5/8	1.52	4.5	4.5	2.9
6-10L XHU86	10L	3/8	5/8	1.57	4.5	4.5	2.9
8-12L XHU86	12L	1/2	13/16	1.69	4.5	4.5	2.9
10-15L XHU86	15L	5/8	15/16	1.98	4.5	4.5	2.9
12-18L XHU86	18L	3/4	1 1/8	2.11	4.5	4.5	2.9
16-22L XHU86	22L	1	1 3/8	2.36	2.3	2.3	1.5
16-28L XHU86	28L	1	1 3/8	2.45	2.3	2.3	1.5
S Series							
4-6S XHU86	6S	1/4	1/2	1.49	7.5	7.5	4.9
6-8S XHU86	8S	3/8	5/8	1.57	7.5	7.5	4.9
6-10S XHU86	10S	3/8	11/16	1.57	7.5	7.5	4.9
8-12S XHU86	12S	1/2	13/16	1.75	6.0	6.0	3.9
10-16S XHU86	16S	5/8	15/16	2.04	5.0	5.0	3.3
12-20S XHU86	20S	3/4	1 1/8	2.29	5.0	5.0	3.3
16-25S XHU86	25S	1	1 3/8	2.45	4.5	4.5	2.9

TABLE OF CONTENTS

VISUAL INDEX

Dimensions and pressures for reference only, subject to change.



TABLE
OF
CONTENTS

VISUAL
INDEX


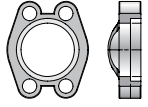
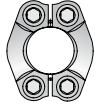

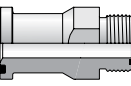
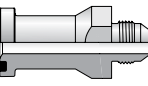
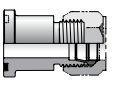
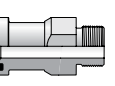
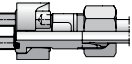
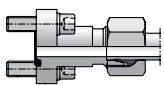




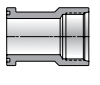
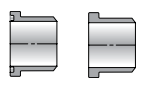
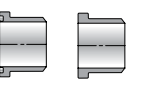



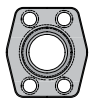
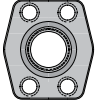
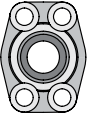
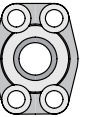
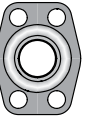
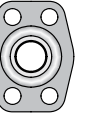
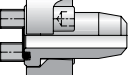
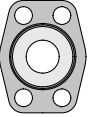
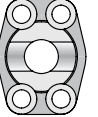
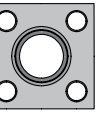
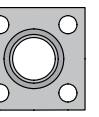
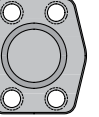
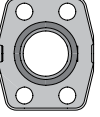
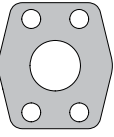
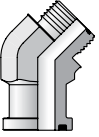
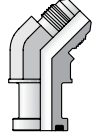
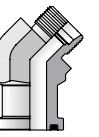
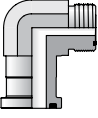
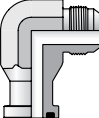
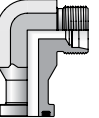
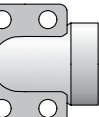
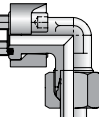


Hydraulic Flanges & Components & Dual Seal Flanges

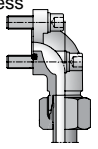
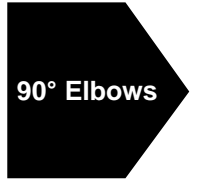
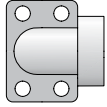
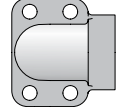
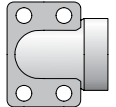
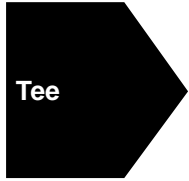
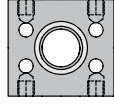

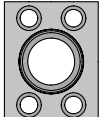
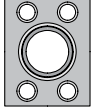
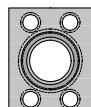
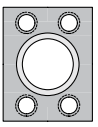


ENGINEERING YOUR SUCCESS.



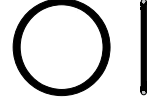
Hydraulic Flanges and Components

<p>Flange Clamps</p>	<p>FCS Flange Clamps – Split</p>  <p>L9</p>	<p>FCC Flange Clamp – Captive</p>  <p>L9</p>	<p>FHS3 Code 61 Flange Clamps – Metric</p>  <p>L10</p>	<p>FHS6 Code 62 Flange Clamps – Metric</p>  <p>L11</p>	
<p>Straight Flange Adapters / Flanges</p>	<p>LOHQ Code 61, 62 / ORFS</p>  <p>L12</p>	<p>XHQ Code 61, 62 / 37° Flare</p>  <p>L12</p>	<p>BUHQ1 Code 61 / Flareless</p>  <p>L12</p>	<p>F5OHQ Code 61, 62 / SAE-ORB</p>  <p>L13</p>	<p>GFS Code 61, 62 / Metric Flareless</p>  <p>L14</p>
<p>BFG DIN Flange / Metric Flareless</p>  <p>L15</p>	<p>B3HQ Code 61, 62 / Flareless</p>  <p>L13</p>	<p>P Flange Head Plug</p>  <p>L15</p>	<p>W7HQ Flange Head / Pipe Socket</p>  <p>L16</p>	<p>G5HQ Flange Head / SAE-ORB</p>  <p>L16</p>	<p>GHQ Flange Head / NPT</p>  <p>L16</p>
<p>WB1/3/5HQ1 Code 61 / Weld Butt – Pipe</p>  <p>L17</p>	<p>WB3/5/7HQ2 Code 62 / Weld Butt – Pipe</p>  <p>L17</p>	<p>G5Q Code 61, 62 / SAE-ORB</p>  <p>L18</p>	<p>GQ Code 61, 62 / NPT</p>  <p>L18</p>	<p>G4Q Code 61, 62 / BSPP</p>  <p>L19</p>	<p>W5Q Code 61, 62 / Socket – Pipe</p>  <p>L20</p>
<p>W4Q Code 61, 62 / Socket – Tube</p>  <p>L21</p>	<p>W7Q Code 61, 62 / Ext Socket – Pipe</p>  <p>L22</p>	<p>W6Q Code 61, 62 / Ext Socket – Tube</p>  <p>L23</p>	<p>WB1/3/5Q1 Code 61 / Weld Butt – Pipe</p>  <p>L24</p>	<p>WB3/5/7Q2 Code 62 / Weld Butt – Pipe</p>  <p>L25</p>	<p>AS Code 61, 62 / Weld Butt – Tube Metric</p>  <p>L26</p>
<p>WBT Code 61 / Weld Tank Adapter</p>  <p>L26</p>	<p>WSD Code 61, 62 / Weld Saddle</p>  <p>L27</p>	<p>GQS Square Flange / NPT</p>  <p>L27</p>	<p>W5SQS Square Flange / Weld Socket – Pipe</p>  <p>L28</p>	<p>PQ Code 61, 62 / Blank</p>  <p>L28</p>	<p>SPGG5 Flange Spacer w/Gage Ports</p>  <p>L29</p>
<p>CP Flange Connector Plate</p>  <p>L29</p>	<p>45° Flange Adapters</p>	<p>LOVQ Code 61, 62 / ORFS</p>  <p>L30</p>	<p>XVQ Code 61, 62 / 37° Flare</p>  <p>L30</p>	<p>BUVQ1 Code 61 / Flareless</p>  <p>L30</p>	
<p>90° Flange Adapters</p>	<p>LOEQ Code 61, 62 / ORFS</p>  <p>L31</p>	<p>XEQ Code 61, 62 / 37° Flare</p>  <p>L31</p>	<p>BUEQ1 Code 61 / Flareless</p>  <p>L31</p>	<p>W7EQ Code 61, 62 / Weld Socket – Pipe</p>  <p>L32</p>	<p>WFS Code 61, 62 / Metric Flareless</p>  <p>L33</p>

**TABLE
 OF
 CONTENTS**

<p>BFW DIN Flange / Metric Flareless</p>  <p>L34</p>	<p>90° Elbows</p> 	<p>G5EQ Code 61, 62 / SAE-ORB</p>  <p>L35</p>	<p>GEQ Code 61, 62 / NPT</p>  <p>L36</p>	<p>W6EQ Code 61, 62 / Weld Socket – Tube</p>  <p>L37</p>	
<p>Tee</p> 	<p>QPQPJQ Code 61, 62 Junction Tee</p>  <p>L35</p>	<p>Stainless Steel Flanges</p> 	<p>G5Q Code 61, 62 / SAE-ORB</p>  <p>L38</p>	<p>GQ Code 61, 62 / NPT</p>  <p>L38</p>	<p>W5Q Code 61, 62 / Weld Socket – Pipe</p>  <p>L39</p>
<p>PQ Code 61, 62 / Blank</p>  <p>L40</p>					


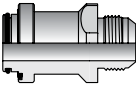

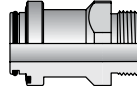
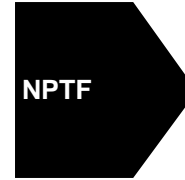
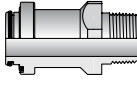
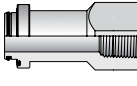

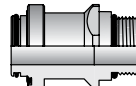
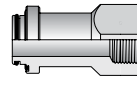

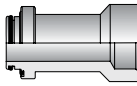
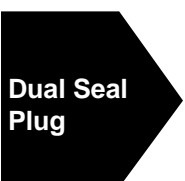





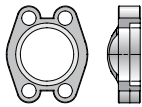
O-Rings and Seals (Shown in Section N)

<p>O-Rings and Seals</p> 	<p>ORFS O-Ring</p>  <p>N4</p>	<p>SAE 4-Bolt Flange O-Ring</p>  <p>N10</p>
---	---	--


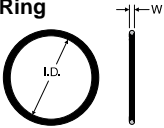
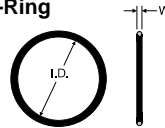
L

TABLE
 OF
 CONTENTS

Dual Seal Flanges

 <p>37° Flare</p>	<p>XHQ40 37° Flare</p>  <p>L41</p>	 <p>ORFS</p>	<p>LOHQ40 ORFS</p>  <p>L41</p>	 <p>NPTF</p>	<p>FHQ40 Male NPTF</p>  <p>L41</p>
<p>GHQ40 Female NPTF</p>  <p>L42</p>	 <p>SAE-ORB</p>	<p>F5OHQ40 Male SAE-ORB</p>  <p>L42</p>	<p>G5HQ40 Female SAE-ORB</p>  <p>L42</p>	 <p>Socket Weld Pipe</p>	<p>W7HQ40 Socket Weld Pipe</p>  <p>L43</p>
 <p>Dual Seal Plug</p>	<p>PQ40 Dual Seal Plug</p>  <p>L43</p>	 <p>Q4 Insert</p>	<p>Q4 Insert Flange Insert</p>  <p>L43</p>		
 <p>Flange Clamps</p>	<p>FCS Flange Clamps – Split</p>  <p>L9</p>	<p>FCC Flange Clamp – Captive</p>  <p>L9</p>			

O-Rings and Seals (Shown in Section N)

 <p>O-Rings and Seals</p>	<p>Radial Seal O-Ring</p>  <p>N10</p>	<p>Flange Seal O-Ring</p>  <p>N10</p>
---	---	---

Hydraulic Flanges and Components

The 4-bolt flange connections conforming to SAE J518 and ISO 6162-1 and -2 are proven, leak-free connections, especially suited for larger sizes, higher pressures and assembly in tight quarters. Threaded port connections such as SAE straight thread O-ring and ISO 6149 are reasonably easy to assemble and provide 6000 psi and higher pressure capability up to size 12 (M27). Beyond this size the pressure rating starts to decrease and assembly torques increase rapidly. The 4-bolt flange port connections provide ability to connect larger sizes and achieve higher-pressure capability at reasonable assembly torques. Because of the lower assembly torques compared to an equivalent size threaded port, these connections are well suited for tight quarters where wrench clearances are limited. Parker 4-bolt flange products described in this part of the catalog provide various means of connecting tubes, hoses, pipes and threaded fittings to 4-bolt flange ports. The discussion below provides an overview of some of the available flange products.

Design and Construction

Parker 4-bolt flange products are designed to provide different methods of connecting a tube, hose, pipe or another fitting to the SAE standard 4-bolt flange port.

Flange Fittings — All Parker flange fittings, except for those with square mounting hole patterns (nomenclature code QS), are designed to conform to O-ring groove, bolt holes and bolt pattern dimensions of either Code 61 or Code 62 of SAE J518 and ISO 6162-1 (Code 61) or -2 (Code 62).

The flange adapters (Code Q1 and Q2), and flange block fittings (Codes Q1B, Q2B and QSB) have O-ring grooves conforming to dimensions in SAE J518. The flange block fittings (Codes Q1B and Q2B) have through holes for the mounting bolts, again conforming to SAE J518. There is no industry standard for the bolt pattern of the square pattern block flanges with codes QSP and QSB.

The flange pad fittings (Codes Q1P, Q2P, and QSP) have a flat face (no O-ring groove) and the mounting holes are tapped. Where these fittings are used, the seal is in the mating part (flange adapter, flange hose fitting, flange block fitting, etc.) as shown in Fig. L1.

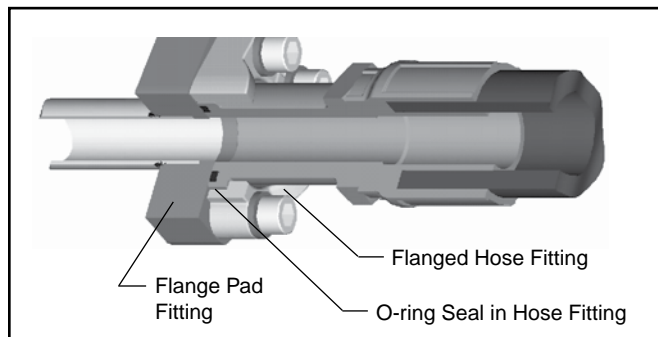


Fig. L1 – Flange Pad Fitting

Dimensions other than the O-ring groove, bolt holes, bolt pattern, and the flange foot print (for codes Q1B and Q2B only) are not governed by any industry standard. However, Parker product design follows common industry practice and sound engineering.

Dimensions and pressures for reference only, subject to change.

Flange Clamps — Clamps are used for providing the holding power to the 4-bolt flange connection. They are offered in split and captive (one-piece) versions. The captive version is also offered with either drilled or tapped bolt holes. The captive flange clamp with tapped holes is used while connecting a tube to another tube or a hose.

Parker flange clamps are forged for higher strength and durability. They meet all requirements of SAE J518. The split clamps make it easy to assemble the connection in close quarters. They also make removal of the flange head component, such as a hose assembly, easy by loosening all four bolts and removing one clamp half, as shown in Fig. L2.

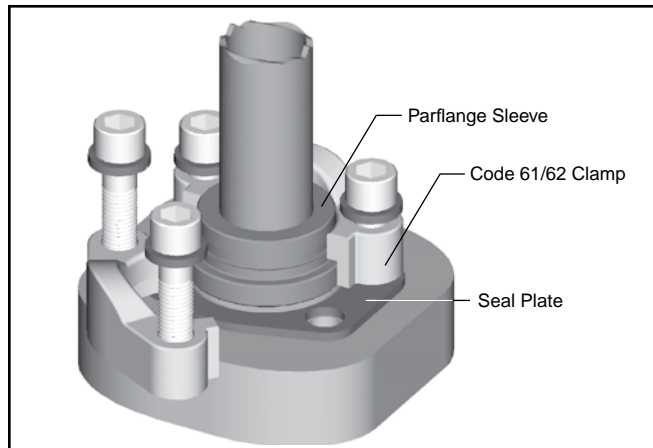


Fig. L2 – Assembly / Removal SAE J518 Connection

Junction Block Tees — These are solid block union fittings to connect two tube/hose assemblies using 4-bolt flange connection, at a junction, to SAE 4-bolt flange port, or three tube/hose assemblies to each other.

Connector Plate — Connector plate is used as a middle plate to connect two flange heads with O-ring grooves, such as two hose assemblies with flange connection ends. The flat surface of the plate provides sealing surface on each side for the O-ring housed in the hose ends.

Spacer Plate — Spacer plate provides access to the system fluid via the gage port on the side. The plate is between the flange connection to provide this access.

Plugs — Plugs provide a means to block off the 4-bolt flange port with and without clamps, and to plug the end of a pipe (via welding).

Tank Weld Adapter — Tank weld adapters provide a means of flange connection to a fabricated reservoir or tank.

Hydraulic Flanges	Steel		Stainless Steel	
	ASTM	Type	ASTM	Type
4-Bolt Flanges	A108	C1020	A240	316L
Flange Clamps	A108	C1045	A351 / A743	Nitronic 50
HHCS Bolts	SAE Grade 8		—	—
SHCS Bolts	—	—	A240	316

Table L1 – Standard Material Specifications for Hydraulic Flanges and Components

Note: Split flange clamps are zinc clear (or Cr6 free) chromate. All other steel flanges are oil dipped. Flange adapters are not plated.

TABLE OF CONTENTS

VISUAL INDEX

L

How Flange Connections Work

The four-bolt flange connection (SAE J518) is a proven leak-free connection, especially suited for larger sizes. As a result, it has achieved worldwide acceptance.

The connection's success is in its simplicity. It is a static face seal using a high durometer O-ring for the seal and clamps and bolts for holding power as shown in Fig. L3. Alternatively, a bonded seal plate is between the port face and the flat face of a mechanically formed (flanged with Parflange® process) tube as shown in Fig. L4 to achieve the same results.

The (O-ring) seal is compressed between the bottom of the groove in the flange head and the flat surface of the port or flange pad, providing a reliable soft seal. The alternate seal plate has a high durometer bonded rubber seal on the inside edge, which compresses between the two flat surfaces, providing a soft seal with the same reliability. A metal-to-metal contact at the outer face of the flange with the port face keeps the seal from extruding under pressure. This metal-to-metal contact is maintained by the clamping force provided by tightening the bolts via the clamps.

This simple design provides several advantages over threaded port connections, such as NPTF, SAE, BSPP, ISO 6149, etc., in larger sizes:

- Ability to connect up to 5 inch O.D tube (Code 61 only)
- Much lower tightening torque required from the four bolts compared to that required for equivalent size threaded port
- Less tightening torque means smaller wrenches and wrench swing clearances — providing ease of assembly in tight quarters
- Up to 6000 psi capability through 2" size (Code 62 only)
- Single seal point between tube/pipe/hose assembly and the port
- Ease of disassembly through use of split clamps

The connection has one disadvantage — it requires a larger area (foot print) on the component than an equivalent threaded port.

Assembly and Installation

Please refer to Section S for the assembly and installation instructions for Hydraulic Flanges and Components fittings.

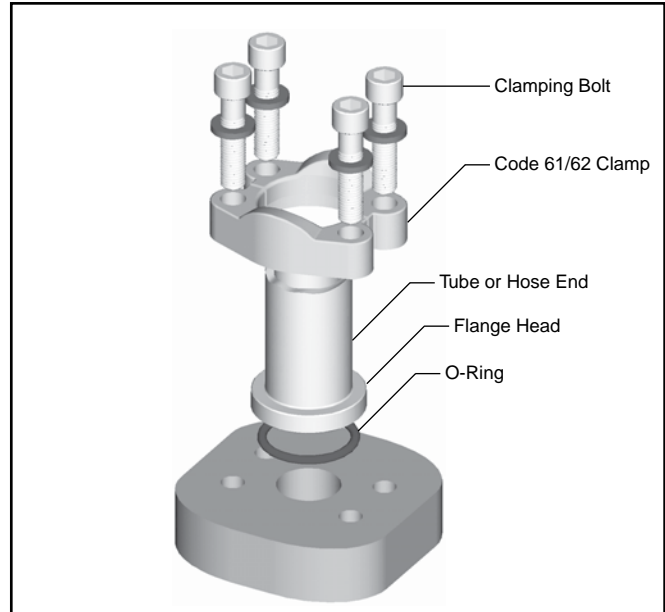


Fig. L3 – Four-Bolt Flange Connection (SAE J518)

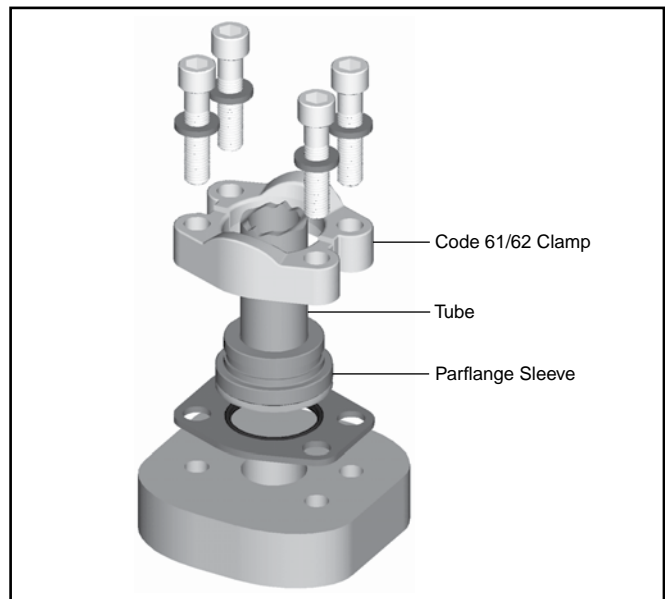


Fig. L4 – Formed Tube with ISO 6162 (SAE J518) Connection

Feature	Advantage	Benefit
Conform to SAE J518 and ISO 6162	Controls dimensions and tolerances of code 61 and 62 port connections	Insures interchangeability and consistency
Forged Construction	Reliable, long life performance	No downtime, reduced costs
	Compact envelope size, no sharp edges	Reduced weight
Over 60 Configurations	Flexibility in plumbing, match system needs	Best solution and best value
Parflange Technology	Designed to be used with Code 61/62 fittings	Eliminates messy and time consuming brazing process
Mounting Hardware	Grade 8 bolts standard	Performs in rigorous applications for the life of the flange
Flange Kits	Flange with hardware for mounting (o-ring, bolts and lockwashers)	Reduces order and assembly error

Dimensions and pressures for reference only, subject to change.

Dual Seal Flange Adapters

Parker's Dual Seal Flange Adapter product line provides a solution for high vibration, high shock hydraulic four bolt connection styles used in various applications. This Parker innovation is offered as an alternative to traditional ISO 6121 (SAE J518) Code 62 Flange connections providing improved port retention, increased sealing capability and elimination of costly field replacement due to failure. Dual Seal Flange Adapters incorporate both radial and face seal technologies, reducing the potential for system leakage and ingress of air or water caused by side loading of traditional flange face seal connections.

Dual Seal Flange Adapters have a system working pressure rating of 7500 PSI with a 4:1 design factor. The face seal system incorporates Parker's Captive O-ring Groove technology to prevent o-ring fall out during installation minimizing connection failures seen with traditional flange connections.

Design and Construction

The Dual Seal Flange adapter consists of three components: a body, a face sealing O-ring and a radial sealing O-ring. The body is manufactured from Heat Code Traceable 316 stainless steel and the O-rings are manufactured from 90 durometer Nitrile. Additional components used for assembly of the Dual Seal Flange adapters include four bolts, flange clamps and lock washers. Flange clamps are available from Parker Tube Fittings Division, with standard sizes listed on Page L9 of this catalog section.

The Dual Seal Flange Adapter Body

Dual Seal Flange Adapters bodies are manufactured in ½", 1" and 1 ½" sizes with ten different cold drawn tube, pipe or hose end configurations available as standard. Straight bodies are machined from 316/316L bar stock.

Dual Seal Flange Clamps

Flange clamps are offered in both split and captive (one-piece) versions depending on the adapter configuration being used. Flange clamps are machined from 316/316L materials. For all straight Dual Seal Flange Adapter bodies split flange clamp are required. The 90° and 45° cast shaped versions can be installed with either split or captive flange clamps.

Industry Acceptance

Dual Seal Flange Adapters are designed to conform to bolt thread and bolt pattern dimensions of ISO 6162-2 or SAE J518 Code 62.

Materials used in the manufacture of Parker Dual Seal Flange Adapters are compliant to NACE MR0175. All products are Heat Code Traceable and have been tested to SAE requirements.

How Dual Seal Flange Adapters Work

As shown below, Dual Seal Flange connections use both a radial seal and face seal to achieve superior leak free port connection. The primary radial seal (A) improves the pressure capabilities of this adapter to 7500 PSI while offering additional system integrity. The face seal (B) provides resistance of external pressures introduced by the application environment. The flange clamps (C) and bolts (D) are used to compress the o-rings into the port and provide the clamping force necessary. Reference Fig. L5 below.

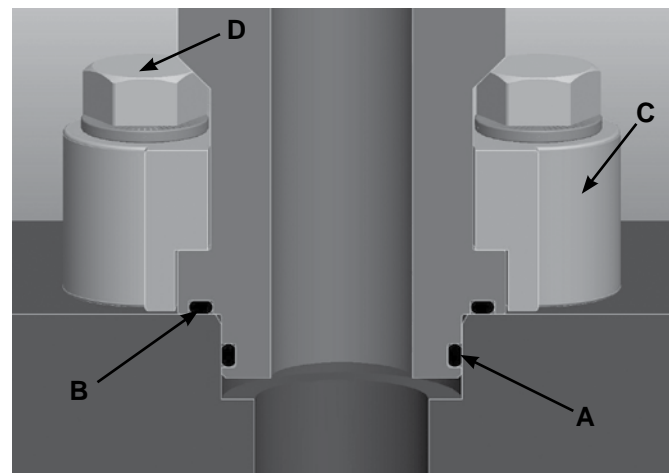


Fig. L5



Dimensions and pressures for reference only, subject to change.

The Parker Advantage

Improved Pressure Rating: Parker's new Dual Seal design is rated for up to 7500 PSI to meet current and future hydraulic design needs. This design has also been tested to meet standard SAE J1644 parameters.

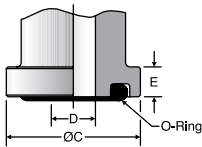
Captive O-ring Groove: The design of Parker's Dual Seal Flange Adapters incorporates a captive O-ring groove (CORG) which prevents O-ring fall out during installation further preventing the possibility of leaks.

Radial Seal: The primary radial seal (A) improves the pressure capabilities of the Dual Seal system to 7500 PSI while offering additional system integrity.

Ingression Seal: Reduces the potential for side loading and ultimately connection failure in high impulse and high vibration applications.

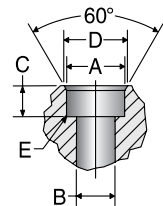
Multiple Standard Configurations: Parker's Dual Seal Flange Adapter product line includes a variety of tube, pipe, and hose connection styles to meet hydraulic system design needs. Included are Parker's Seal-Lok (SAE J1453), Triple-Lok (SAE J514), SAE ORB (SAE J1926) and NPTF for traditional hydraulic connections. In addition, to offer a solution for schedule pipe assemblies, Parker offers socket weld configurations.

Code 61 and Code 62 Port Ends



	Flange O.D. C	Drill D Max	Flange Height E
SIZE	(inch)	(inch)	(inch)
CODE 61			
8	1.19	0.50	0.265
12	1.50	0.75	0.265
16	1.75	1.00	0.315
20	2.00	1.25	0.315
24	2.38	1.50	0.315
32	2.81	2.00	0.375
CODE 62			
8	1.25	0.50	0.305
12	1.63	0.75	0.345
16	1.88	1.00	0.375
20	2.13	1.25	0.405
24	2.50	1.50	0.495
32	3.13	2.00	0.495

Port Ends for Dual Seal Flange Port



SIZE	A (in.)	B (in.)	C (in.)	D (CSK)	E (R)
8	0.750 - 0.752	0.500	0.400	.82 X 60°	0.02
16	1.375 - 1.377	0.938	0.400	1.445 X 60°	0.02
24	1.750 - 1.752	1.312	0.530	1.82 X 60°	0.02

Dimensions and pressures for reference only, subject to change.

FCS

Code 61/62 Flange Clamps, Split

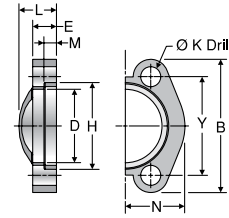


TABLE
OF
CONTENTS

VISUAL
INDEX

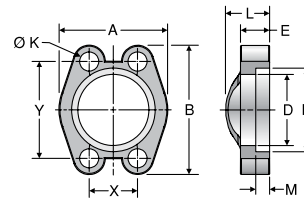
TUBE FITTING PART #	HOSE PRODUCTS PART #	HOSE PRODUCTS PART #	FLANGE SIZE (in.)	B (in.)	D (in.)	E (in.)	H (in.)	K DRILL DIA. (in.)	L (in.)	M (in.)	N (in.)	Y (in.)	MOUNTING HARDWARE HHCS	Dynamic Pressure (x 1,000 PSI)	
FLANGE HALF	FLANGE HALF	KIT												-S	-SS
CODE 61 FLANGE CLAMPS, SPLIT															
8FCS1	51H-8	5151HK-8	0.50	2.12	0.955	0.50	1.22	0.344	0.75	0.245	0.86	1.50	5/16-18 x 1.25	5.0	5.0
12FCS1	51H-12	5151HK-12	0.75	2.56	1.265	0.56	1.53	0.406	0.88	0.245	0.98	1.88	3/8-16 x 1.25	5.0	5.0
16FCS1	51H-16	5151HK-16	1.00	2.75	1.515	0.62	1.78	0.406	0.94	0.295	1.11	2.06	3/8-16 x 1.25	5.0	5.0
20FCS1	51H-20	5151HK-20	1.25	3.12	1.720	0.56	2.03	0.469	0.88	0.295	1.39	2.31	7/16-14 x 1.50	4.0	4.0
24FCS1	51H-24	5151HK-24	1.50	3.69	2.000	0.62	2.41	0.531	1.00	0.295	1.58	2.75	1/2-13 x 1.50	3.0	3.0
32FCS1	51H-32	5151HK-32	2.00	4.00	2.470	0.62	2.84	0.531	1.03	0.355	1.86	3.06	1/2-13 x 1.50	3.0	3.0
40FCS1	51H-40	5151HK-40	2.50	4.50	2.950	0.75	3.34	0.531	1.50	0.355	2.09	3.50	1/2-13 x 1.75	2.5	2.5
48FCS1	51H-48	5151HK-48	3.00	5.31	3.580	0.88	4.03	0.656	1.62	0.355	2.53	4.19	5/8-11 x 1.75	2.0	2.0
56FCS1	51H-56	5151HK-56	3.50	6.00	4.030	0.88	4.53	0.656	1.12	0.422	2.70	4.75	5/8-11 x 1.75	0.5	0.5
64FCS1	51H-64	5151HK-64	4.00	6.38	4.530	1.00	5.03	0.656	1.38	0.422	2.95	5.13	5/8-11 x 2.00	0.5	0.5
CODE 62 FLANGE CLAMPS, SPLIT															
12FCS2	HFH-12	HFHFHK-12	0.75	2.81	1.280	0.75	1.66	0.406	1.12	0.325	1.14	2.00	3/8-16 x 1.50	6.0	6.0
16FCS2	HFH-16	HFHFHK-16	1.00	3.19	1.530	0.94	1.91	0.469	1.31	0.355	1.33	2.25	7/16-14 x 1.75	6.0	6.0
20FCS2	HFH-20	HFHFHK-20	1.25	3.75	1.750	1.06	2.16	0.531	1.50	0.385	1.48	2.63	1/2-13 x 1.75	6.0	6.0
24FCS2	HFH-24	HFHFHK-24	1.50	4.44	2.030	1.19	2.53	0.656	1.69	0.475	1.83	3.13	5/8-11 x 2.25	6.0	6.0
32FCS2	HFH-32	HFHFHK-32	2.00	5.25	2.660	1.44	3.16	0.781	2.06	0.475	2.20	3.81	3/4-10 x 2.75	6.0	6.0

To order a flange clamp split kit, insert a "K" after the material designator in the Tube Fitting part number. The Kit includes two flange clamp halves, 4 HHCS bolts, 4 lock washers and an O-ring.

L

FCC

Code 61/62 Flange Clamp, Captive



TUBE FITTING PART #	FLANGE SIZE (in.)	A (in.)	B (in.)	D (in.)	E (in.)	H (in.)	K DRILL DIA. (in.)	L (in.)	M (in.)	T TAP UN-2B (in.)	X (in.)	Y (in.)	MOUNTING HARDWARE HHCS	Dynamic Pressure (x 1,000 PSI)		
DRILLED HOLES	TAPPED HOLES													-SX	-SS	
CODE 61 FLANGE CLAMP, CAPTIVE																
8FCC1	8FCCT1	0.50	1.81	2.125	0.955	0.50	1.219	0.344	0.75	0.245	5/16-18	0.688	1.500	5/16-18 x 1.25	5.0	
12FCC1	12FCCT1	0.75	2.06	2.560	1.265	0.56	1.531	0.406	0.88	0.245	3/8-16	0.875	1.875	3/8-16 x 1.25	5.0	
16FCC1	16FCCT1	1.00	2.31	2.750	1.515	0.62	1.781	0.406	0.94	0.295	3/8-16	1.031	2.062	3/8-16 x 1.25	5.0	
20FCC1	20FCCT1	1.25	2.88	3.125	1.720	0.56	2.031	0.469	0.88	0.295	7/16-14	1.188	2.312	7/16-14 x 1.50	4.0	
24FCC1	24FCCT1	1.50	3.25	3.705	2.000	0.62	2.406	0.531	1.00	0.295	1/2-13	1.406	2.750	1/2-13 x 1.50	3.0	
32FCC1	32FCCT1	2.00	3.81	4.000	2.470	0.62	2.844	0.531	1.03	0.355	1/2-13	1.688	3.062	1/2-13 x 1.50	3.0	
40FCC1	40FCCT1	2.50	4.28	4.500	2.950	0.75	3.344	0.531	1.50	0.355	1/2-13	2.000	3.500	1/2-13 x 1.75	2.5	
48FCC1	48FCCT1	3.00	5.16	5.315	3.580	0.88	4.031	0.656	1.62	0.355	5/8-11	2.438	4.188	5/8-11 x 1.75	2.0	
56FCC1	56FCCT1	3.50	5.50	6.000	4.030	0.88	4.531	0.656	1.12	0.422	5/8-11	2.750	4.750	5/8-11 x 1.75	0.5	
64FCC1	64FCCT1	4.00	6.00	6.375	4.530	1.00	5.031	0.656	1.38	0.422	5/8-11	3.062	5.125	5/8-11 x 2.00	0.5	
CODE 62 FLANGE CLAMP, CAPTIVE																
12FCC2	12FCCT2	0.75	2.38	2.810	1.280	0.75	1.656	0.406	1.12	0.325	3/8-16	0.938	2.000	3/8-16 x 1.50	6.0	
16FCC2	16FCCT2	1.00	2.75	3.190	1.530	0.94	1.906	0.469	1.31	0.355	7/16-14	1.094	2.250	7/16-14 x 1.75	6.0	
20FCC2	20FCCT2	1.25	3.06	3.750	1.750	1.06	2.156	0.531	1.50	0.385	1/2-13	1.250	2.625	1/2-13 x 1.75	6.0	
24FCC2	24FCCT2	1.50	3.75	4.440	2.030	1.19	2.531	0.656	1.69	0.475	5/8-11	1.438	3.125	5/8-11 x 2.25	6.0	
32FCC2	32FCCT2	2.00	4.50	5.250	2.660	1.44	3.156	0.781	2.06	0.475	3/4-10	1.750	3.8120	3/4-10 x 2.75	6.0	

Dimensions and pressures for reference only, subject to change.



FHS3
 Flange Components

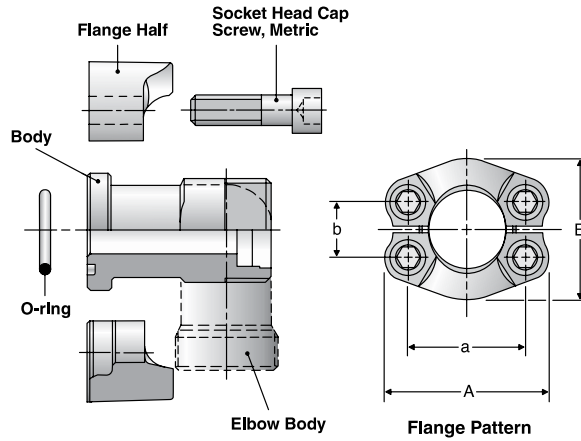


TABLE
 OF
 CONTENTS

VISUAL
 INDEX

Code 61
 For Straights and Elbows
 (ISO 6162-1, Type 1)

Size	For Tube O.D. Series	Working Pressure (bar)	SAE Flange Halves	4 Socket Head Cap Screws DIN 912-8.8	O-Ring
1/2	15L	315	FHS 32CFX	M8X30	OR18.64 x 3.53X
1/2	16S	350			
3/4	18L	315	FHS 33CFX	M10X35	OR25.00 x 3.53X
3/4	22L	160			
3/4	20S	350			
3/4	25S	350			
1	28L	160	FHS 34CFX	M10X35	OR32.92 x 3.53X
1	30S	350			
1 1/4	35L	160	FHS 35CFX	M12X40*	OR37.70 x 3.53X
1 1/4	25S	280			
1 1/4	30S	280			
1 1/4	38S	280			
1 1/2	42L	160	FHS 36CFX	M12X40	OR47.22 x 3.53X
1 1/2	38S	210			

Size	For Tube O.D. Series	A ≈	B ≈	a	b
1/2	15L	54	46	38.1	17.5
1/2	16S	54	46	38.1	17.5
3/4	18L	65	52	47.6	22.2
3/4	22L	65	52	47.6	22.2
3/4	20S	65	52	47.6	22.2
3/4	25S	65	52	47.6	22.2
1	28L	70	59	52.4	26.2
1	30S	70	59	52.4	26.2
1 1/4	35L	79	73	58.7	30.2
1 1/4	25S	79	73	58.7	30.2
1 1/4	30S	79	73	58.7	30.2
1 1/4	38S	79	73	58.7	30.2
1 1/2	42L	94	83	69.9	35.7
1 1/2	38S	94	83	69.9	35.7

Temperature range without pressure reductions for fittings with O-ring sealing of NBR (e.g., buna N series) -35°C up to +100°C, FPM (e.g., fluorocarbon on request) -25°C up to +120°C.

Tightening torques for socket head cap screws see Table S6.

* Does not meet ISO 6162 specification.

Note: Clamp halves are sold separately, not as a set.

Dimensions and pressures for reference only, subject to change.

FHS6

Flange Components

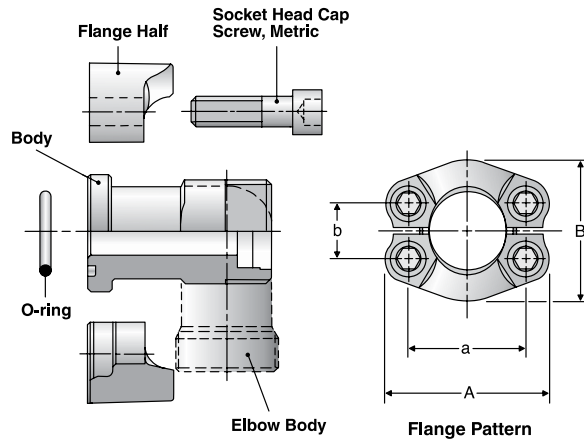


TABLE
 OF
 CONTENTS

VISUAL
 INDEX

Code 62

For Straights and Elbows
 (ISO 6162-2, Type 1)

Size	For Tube O.D. Series	Working Pressure (bar)	SAE Flange Halves	4 Socket Head Cap Screws DIN 912-8.8	O-Ring
1/2	16S	400	FHS 62CFX	M8X35	OR18.64 x 3.53X
3/4	16S	400	FHS 63CFX	M10X35	OR25.00 x 3.53X
3/4	20S	400	FHS 63CFX	M10X35	OR25.00 x 3.53X
3/4	25S	400	FHS 63CFX	M10X35	OR25.00 x 3.53X
1	25S	400	FHS 64CFX	M12X45	OR32.92 x 3.53X
1	30S	400	FHS 64CFX	M12X45	OR32.92 x 3.53X
1 1/4	30S	400	FHS 65CFX	M14X50*	OR37.70 x 3.53X
1 1/4	38S	315	FHS 65CFX	M14X50*	OR37.70 x 3.53X
1 1/2	38S	315	FHS 66CFX	M16X55	OR47.22 x 3.53X

Size	For Tube O.D. Series	A ≈	a	B ≈	b
1/2	16S	56	40.5	47	18.2
3/4	16S	71	50.8	60	23.8
3/4	20S	71	50.8	60	23.8
3/4	25S	71	50.8	60	23.8
1	25S	81	57.2	70	27.8
1	30S	81	57.2	70	27.8
1 1/4	30S	95	66.7	77	31.8
1 1/4	38S	95	66.7	77	31.8
1 1/2	38S	113	79.4	95	36.5

Temperature range without pressure reductions for fittings with O-ring sealing of NBR (e.g., buna N series) -35° up to +100°C, FPM (e.g., fluorocarbon on request) -25° up to +120°C.

Tightening torques for socket head cap screws see Table S7.

* Does not meet ISO 6162 specification.

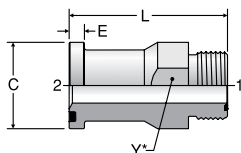
Note: Clamp halves are sold separately, not as a set.

L

Dimensions and pressures for reference only, subject to change.

LOHQ1

Code 61 Flange Connector
Code 61 / ORFS

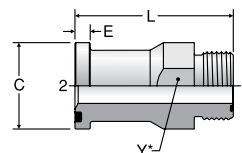


* Y – Across Wrench Flats

TUBE FITTING PART #	END SIZE		C (in.)	E (in.)	L (in.)	Y (in.)	Dynamic Pressure (x 1,000 PSI) -S
	1 (in.)	2 Code 61					
12 LOHQ1	3/4	3/4	1.500	0.265	2.79	1 3/8	5.0
16 LOHQ1	1	1	1.750	0.315	2.81	1 5/8	5.0
20 LOHQ1	1 1/4	1 1/4	2.000	0.315	3.21	1 7/8	4.0
24 LOHQ1	1 1/2	1 1/2	2.375	0.315	3.29	2 1/8	3.0

LOHQ2

Code 62 Flange Connector
Code 62 / ORFS



* Y – Across Wrench Flats

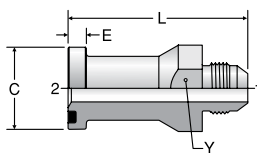
TUBE FITTING PART #	END SIZE		C (in.)	E (in.)	L (in.)	Y (in.)	Dynamic Pressure (x 1,000 PSI) -S
	1 (in.)	2 Code 62					
12 LOHQ2	3/4	3/4	1.625	0.345	3.02	1 3/8	6.0
12-16 LOHQ2	3/4	1	1.875	0.375	3.34	1 5/8	6.0
16 LOHQ2	1	1	1.875	0.375	3.36	1 5/8	6.0
20 LOHQ2	1 1/4	1 1/4	2.125	0.405	3.48	1 7/8	5.0
24 LOHQ2	1 1/2	1 1/2	2.500	0.495	4.14	2 1/8	4.5

TABLE
OF
CONTENTS

VISUAL
INDEX

XHQ1

Code 61 Flange Connector
Code 61 / 37° Flare

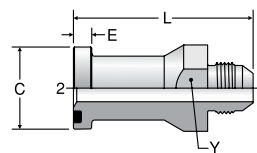


* Y – Across Wrench Flats

TUBE FITTING PART #	END SIZE		C (in.)	E (in.)	L (in.)	Y (in.)	Dynamic Pressure (x 1,000 PSI) -S
	1 (in.)	2 Code 61					
12 XHQ1	3/4	3/4	1.500	0.265	2.77	1 3/8	5.0
16 XHQ1	1	1	1.750	0.315	2.91	1 5/8	5.0
20 XHQ1	1 1/4	1 1/4	2.000	0.315	3.36	1 7/8	4.0
24 XHQ1	1 1/2	1 1/2	2.375	0.315	3.57	2 1/8	3.0
32 XHQ1	2	2	2.812	0.375	4.04	2 5/8	2.0

XHQ2

Code 62 Flange Connector
Code 62 / 37° Flare

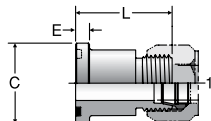


* Y – Across Wrench Flats

TUBE FITTING PART #	END SIZE		C (in.)	E (in.)	L (in.)	Y (in.)	Dynamic Pressure (x 1,000 PSI) -S
	1 (in.)	2 Code 62					
12 XHQ2	3/4	3/4	1.625	0.345	3.08	1 3/8	5.0
16 XHQ2	1	1	1.875	0.375	3.43	1 5/8	5.0
20 XHQ2	1 1/4	1 1/4	2.125	0.405	3.60	1 7/8	4.0
24 XHQ2	1 1/2	1 1/2	2.500	0.495	4.34	2 1/8	3.0

BUHQ1

Code 61 Connector
Code 61 / Flareless

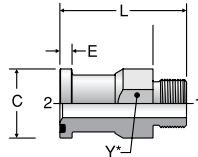


TUBE FITTING PART #	END SIZE		C (in.)	E (in.)	L (in.)	Dynamic Pressure (x 1,000 PSI) -S
	1 (in.)	2 Code 61				
12 BUHQ1	3/4	3/4	1.500	0.265	1.82	
16 BUHQ1	1	1	1.750	0.315	1.88	
20 BUHQ1	1 1/4	1 1/4	2.000	0.315	1.82	
24 BUHQ1	1 1/2	1 1/2	2.375	0.315	1.94	
32 BUHQ1	2	2	2.812	0.375	1.97	

Dimensions and pressures for reference only, subject to change.

F50HQ1

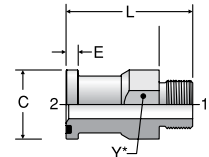
Code 61 Connector
Code 61 / SAE-ORB



*Y – Across Wrench Flats

F50HQ2

Code 62 Connector
Code 62 / SAE-ORB



*Y – Across Wrench Flats

TABLE
OF
CONTENTS

VISUAL
INDEX

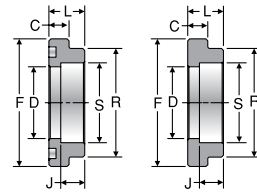
TUBE FITTING PART #	END SIZE		C (in.)	E (in.)	L (in.)	Y (in.)	Dynamic Pressure (x 1,000 PSI) -S
	1 (in.)	2 Code 61					
12 F50HQ1	3/4	3/4	1.500	0.265	2.63	1 3/8	5.0
16 F50HQ1	1	1	1.750	0.315	2.73	1 5/8	4.5
20 F50HQ1	1 1/4	1 1/4	2.000	0.315	3.13	1 7/8	4.0
24 F50HQ1	1 1/2	1 1/2	2.375	0.315	3.22	2 1/8	3.0
32 F50HQ1	2	2	2.812	0.375	3.49	2 3/4	3.0

TUBE FITTING PART #	END SIZE		C (in.)	E (in.)	L (in.)	Y (in.)	Dynamic Pressure (x 1,000 PSI) -S
	1 (in.)	2 Code 62					
12 F50HQ2	3/4	3/4	1.625	0.345	3.08	1 3/8	6.0
16 F50HQ2	1	1	1.875	0.375	3.25	1 5/8	5.5
20 F50HQ2	1 1/4	1 1/4	2.125	0.405	3.37	1 7/8	4.5
24 F50HQ2	1 1/2	1 1/2	2.500	0.495	3.99	2 1/8	4.5
32 F50HQ2	2	2	3.125	0.495	4.86	2 3/4	3.0

B3HQ

Braze Flange Head Connector, Tube
Tube Braze Socket* / Code 61/62 Flange Head

* For clearance brazing



O-ring Face Flat Face

TUBE FITTING PART #		FLANGE SIZE (in.)	TUBE O.D. (in.)	C (in.)	D (in.)	F (in.)	J (in.)	L (in.)	R (in.)	S (in.)	Dynamic Pressure (x 1,000 PSI)	
O-RING FACE	FLAT FACE										-SX	-SS
TUBE BRAZE SOCKET / CODE 61 FLANGE HEAD												
8B3HQ1	8B3HQ1N	0.50	1/2	0.265	0.406	1.188	0.312	0.50	0.940	0.502	5.0	
10-8B3HQ1	10-8B3HQ1N	0.50	5/8	0.265	0.500	1.188	0.312	0.50	0.940	0.625	5.0	
12B3HQ1	12B3HQ1N	0.75	3/4	0.265	0.656	1.500	0.375	0.56	1.250	0.752	4.5	
16-12B3HQ1	16-12B3HQ1N	0.75	1	0.315	0.750	1.500	0.375	0.56	1.250	1.002	4.5	
16B3HQ1	16B3HQ1N	1.00	1	0.315	0.906	1.750	0.375	0.56	1.500	1.002	4.5	
20-16B3HQ1	20-16B3HQ1N	1.00	1 1/4	0.315	1.000	1.750	0.375	0.56	1.500	1.252	4.0	
20B3HQ1	20B3HQ1N	1.25	1 1/4	0.315	1.125	2.000	0.375	0.56	1.700	1.252	3.5	
24-20B3HQ1	24-20B3HQ1N	1.25	1 1/2	0.315	1.250	2.000	0.375	0.56	1.700	1.502	3.5	
24B3HQ1	24B3HQ1N	1.50	1 1/2	0.315	1.375	2.380	0.438	0.62	1.980	1.502	3.0	
28-24B3HQ1	28-24B3HQ1N	1.50	1 3/4	0.315	1.500	2.380	0.438	0.62	1.980	1.752	2.7	
32B3HQ1	32B3HQ1N	2.00	2	0.375	1.875	2.810	0.500	0.62	2.450	2.002	3.0	
36-32B3HQ1	36-32B3HQ1N	2.00	2 1/4	0.375	2.000	2.810	0.500	0.62	2.450	2.252	3.0	
40B3HQ1	40B3HQ1N	2.50	2 1/2	0.375	2.375	3.312	0.562	0.68	2.921	2.502	2.2	
44-40B3HQ1	44-40B3HQ1N	2.50	2 3/4	0.375	2.500	3.312	0.500	0.68	2.921	2.752	2.2	
48B3HQ1	48B3HQ1N	3.00	3	0.375	2.875	4.000	0.562	0.75	3.546	3.002	1.7	
TUBE BRAZE SOCKET / CODE 62 FLANGE HEAD												
12B3HQ2	12B3HQ2N	0.75	3/4	0.345	0.656	1.625	0.500	0.69	1.250	0.752	6.0	
16-12B3HQ2	16-12B3HQ2N	0.75	1	0.345	0.750	1.625	0.500	0.69	1.250	1.002	6.0	
16B3HQ2	16B3HQ2N	1.00	1	0.375	0.810	1.875	0.625	0.81	1.500	1.002	6.0	
20-16B3HQ2	20-16B3HQ2N	1.00	1 1/4	0.375	1.000	1.875	0.625	0.81	1.500	1.252	6.0	
20B3HQ2	20B3HQ2N	1.25	1 1/4	0.405	1.010	2.125	0.812	1.00	1.718	1.252	6.0	
24-20B3HQ2	24-20B3HQ2N	1.25	1 1/2	0.405	1.250	2.125	0.812	1.00	1.718	1.502	5.5	
24B3HQ2	24B3HQ2N	1.50	1 1/2	0.495	1.250	2.500	1.000	1.19	2.000	1.502	6.0	
28-24B3HQ2	28-24B3HQ2N	1.50	1 3/4	0.495	1.500	2.500	1.000	1.19	2.000	1.752	4.5	
32B3HQ2	32B3HQ2N	2.00	2	0.495	1.750	3.125	1.375	1.50	2.620	2.002	5.5	
36-32B3HQ2	36-32B3HQ2N	2.00	2 1/4	0.495	2.000	3.125	1.312	1.50	2.620	2.252	4.0	

Dimensions and pressures for reference only, subject to change.

GFS

SAE Flange Connector – Standard Series
Code 61 & 62 / Metric Flareless

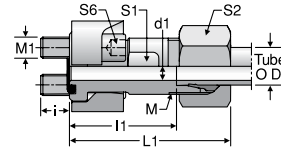


TABLE
OF
CONTENTS

VISUAL
INDEX

TUBE FITTING PART #	SIZE (in.)	TUBE O.D. (mm)	WORKING PRESSURE (bar)	M THREAD	d1 (mm)	i (mm)	l1 (mm)	L1 (mm)	S1 (mm)	S2 (mm)	S6 (mm)	MATERIAL FROM STOCK		EO-2 FROM STOCK	
												CF	71	CF	71
SAE FLANGE CONNECTIONS – CODE 61 – STANDARD SERIES															
GFS32/15LCF	1/2	15L	200	M22 x 1.5	12	11.5	41	56	24	27	6	•		•	
GFS32/16SCF	1/2	16S	220	M24 x 1.5	12	11.5	41.5	60	24	30	6	•		•	
GFS33/18LCF	3/4	18L	200	M26 x 1.5	15	15.5	45.5	62	30	32	8	•		•	
GFS33/22LCF	3/4	22L	100	M30 x 2	19	15.5	45.5	62	30	36	8	•		•	
GFS33/20SCF	3/4	20S	220	M30 x 2	16	15.5	46.5	68	30	36	8	•		•	
GFS33/25SCF	3/4	25S	220	M36 x 2	17	15.5	45	69	30	46	8	•		•	
GFS34/28LCF	1	28L	100	M36 x 2	24	13.5	46.5	63	36	41	8	•		•	
GFS34/30SCF	1	30S	220	M42 x 2	24	13.5	49.5	76	36	50	8	•		•	
GFS35/35LCF	1 1/4	35L	100	M45 x 2	30	18.5	47.5	69	41	50	8	•		•	
GFS35/25SCF	1 1/4	25S	175	M36 x 2	20	18.5	48	72	41	46	8	•		•	
GFS35/30SCF	1 1/4	30S	175	M42 x 2	25	18.5	48.5	75	41	50	8	•		•	
GFS35/38SCF	1 1/4	38S	175	M52 x 2	28	18.5	50	81	46	60	8	•		•	
GFS36/42LCF	1 1/2	42L	100	M52 x 2	36	18.5	53	76	46	60	10	•		•	
GFS36/38SCF	1 1/2	38S	130	M52 x 2	32	18.5	54	85	46	60	10	•		•	
SAE FLANGE CONNECTIONS – CODE 62 – HIGH PRESSURE SERIES															
GFS62/16SCF	1/2	16S	250	M24 x 1.5	12	13.5	44.5	63	24	30	6	•		•	
GFS63/16SCF	3/4	16S	250	M24 x 1.5	12	15.5	50.5	69	30	30	8	•		•	
GFS63/20SCF	3/4	20S	250	M30 x 2	16	15.5	50.5	72	30	36	8	•		•	
GFS63/25SCF	3/4	25S	250	M36 x 2	17	15.5	51	75	30	46	8	•		•	
GFS64/25SCF	1	25S	250	M36 x 2	20	20.5	60	84	36	46	10	•		•	
GFS64/30SCF	1	30S	250	M42 x 2	24	20.5	60.5	87	36	50	10	•		•	
GFS65/30SCF	1 1/4	30S	250	M42 x 2	25	22.5	65.5	92	41	50	10	•		•	
GFS65/38SCF	1 1/4	38S	200	M52 x 2	30	22.5	67	98	46	60	10	•		•	
GFS66/38SCF	1 1/2	38S	200	M52 x 2	30	24.5	73	104	46	60	14	•		•	

EO-2 Part Number example: GFS33/18ZLCF

Temperature range without pressure reductions for fittings with O-ring sealing of NBR (e.g., buna N series) -35°C up to +100°C, FPM (e.g., fluorocarbon on request) -25°C up to +120°C.

Tightening torques for socket head cap screws see Tables S6 and S7.

Dimensions and pressures for reference only, subject to change.



BFG

DIN Flange / Metric Flareless

Tube connection according to DIN 2353

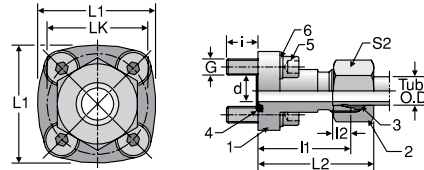


TABLE
OF
CONTENTS

VISUAL
INDEX

TUBE FITTING PART #	WORKING PRESSURE (bar)	TUBE O.D. (mm)	d (mm)	G	i (mm)	I1 (mm)	I2 (mm)	L1 (mm)	L2 (mm)	LK (mm)	S2 (mm)	MATERIAL FROM STOCK		EO-2 FROM STOCK	
												CF	71	CF	71
BFG15L/LK40CF	65	15	12	M 6	12.5	35	7	42	43	40	27	•		•	
BFG18L/LK40CF	65	18	15	M 6	12.5	35	7.5	42	44	40	32	•		•	
BFG22L/LK40CF	65	22	19	M 6	12.5	35	7.5	42	44.5	40	36	•		•	
BFG15L/LK35CF	155	15	12	M 6	12.5	30	7	39	38	35	27	•		•	
BFG10L/LK35CF	200	10	8	M 6	12.5	30	7	39	39	35	19	•		•	
BFG12L/LK35CF	200	12	10	M 6	12.5	30	7	39	39	35	22	•		•	

Unassembled BFG Fitting Components

1 Straight Body	2 Nut	3 Progressive Ring	4 O-Ring	5 Cap Screws DIN 912-8.8 (4 pcs.)	6 Spring Washer DIN 127 (4 pcs.)
BFG15L/LK40CFX	M15LCFX	DPR15LCFX	OR26X2.5X	M6X22	A6
BFG15L/LK40CFX	M18LCFX	DPR18LCFX	OR26X2.5X	M6X22	A6
BFG22L/LK40CFX	M22LCFX	DPR22LCFX	OR26X2.5X	M6X22	A6
BFG15L/LK35CFX	M15LCFX	DPR15LCFX	OR20X2.5X	M6X22	A6
BFG10L/LK35CFX	M10LCFX	DPR10LCFX	OR20X2.5X	M6X22	A6
BFG12L/LK35CFX	M12LCFX	DPR12LCFX	OR20X2.5X	M6X22	A6

EO-2 Part Number example: BFG15ZL/LK40CF

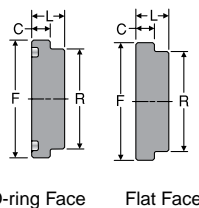
Temperature range without pressure reductions for fittings with O-ring sealing of NBR (e.g., buna N series) -35°C up to +100°C, FPM (e.g., fluorocarbon on request) -25°C up to 120°C.

Tightening torques for socket head cap screws see Table S6.

L

P

Flange Head Plug Code 61/62 Flange Head Plug



O-ring Face Flat Face

TUBE FITTING PART #		FLANGE SIZE (in.)	C (in.)	F (in.)	L (in.)	R (in.)	Dynamic Pressure (x 1,000 PSI)	
O-RING FACE	FLAT FACE						-SX	-SS
CODE 61 FLANGE HEAD PLUG								
8PQ1	8PQ1N	0.50	0.265	1.188	0.500	0.940	5.0	
12PQ1	12PQ1N	0.75	0.265	1.500	0.560	1.250	5.0	
16PQ1	16PQ1N	1.00	0.315	1.750	0.560	1.500	5.0	
20PQ1	20PQ1N	1.25	0.315	2.000	0.560	1.700	4.0	
24PQ1	24PQ1N	1.50	0.315	2.380	0.620	1.980	3.0	
32PQ1	32PQ1N	2.00	0.375	2.810	0.620	2.450	3.0	
40PQ1	40PQ1N	2.50	0.375	3.312	0.680	2.921	2.5	
48PQ1	48PQ1N	3.00	0.375	4.000	0.750	3.546	2.0	
CODE 62 FLANGE HEAD PLUG								
12PQ2	12PQ2N	0.75	0.345	1.625	0.687	1.250	6.0	
16PQ2	16PQ2N	1.00	0.375	1.875	0.812	1.500	6.0	
20PQ2	20PQ2N	1.25	0.405	2.125	1.000	1.718	6.0	
24PQ2	24PQ2N	1.50	0.495	2.500	1.187	2.000	6.0	
32PQ2	32PQ2N	2.00	0.495	3.125	1.500	2.625	6.0	

Dimensions and pressures for reference only, subject to change.



W7HQ

Weld Socket Flange Connector, Pipe
Extended Weld Socket, Pipe / Code 61 or 62 Flange Head

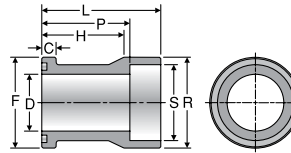


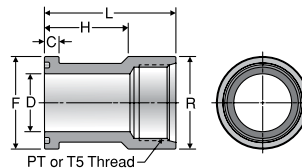
TABLE
OF
CONTENTS

VISUAL
INDEX

TUBE FITTING PART #	PIPE SIZE (in.)	FLANGE SIZE (in.)	C (in.)	D (in.)	F (in.)	H (in.)	L (in.)	P (in.)	R (in.)	S (in.)	Dynamic Pressure (x 1,000 PSI)	
											SX	SS
EXTENDED WELD SOCKET, PIPE / CODE 61 FLANGE HEAD												
12W7HQ1	3/4	0.75	0.265	0.750	1.500	1.62	2.34	1.78	1.500	1.062	3.5	
16W7HQ1	1	1.00	0.315	1.000	1.750	1.62	2.38	1.75	1.750	1.328	3.5	
20W7HQ1	1 1/4	1.25	0.315	1.250	2.000	1.81	2.62	1.94	2.000	1.672	3.5	
24W7HQ1	1 1/2	1.50	0.315	1.500	2.375	2.00	2.88	2.12	2.375	1.922	2.7	
32W7HQ1	2	2.00	0.375	2.000	2.812	2.00	3.00	2.12	2.812	2.406	2.5	
EXTENDED WELD SOCKET, PIPE / CODE 62 FLANGE HEAD												
16W7HQ2	1	1.00	0.375	1.000	1.875	2.34	3.06	2.43	2.000	1.328	5.5	
20W7HQ2	1 1/4	1.25	0.405	1.125	2.125	2.50	3.31	2.62	2.312	1.672	5.5	
24W7HQ2	1 1/2	1.50	0.495	1.375	2.500	3.06	3.93	3.18	2.750	1.922	5.5	
32W7HQ2	2	2.00	0.495	1.875	3.125	3.18	4.06	3.18	3.250	2.406	5.0	

GHQ / G5HQ

Threaded Port Flange Adapter
NPTF or SAE Port / Code 61 Flange Head



GHQ

TUBE FITTING PART #	PT PORT THREAD NPTF	FLANGE SIZE (in.)	C (in.)	D (in.)	F (in.)	H (in.)	L (in.)	R (in.)	Dynamic Pressure (x 1,000 PSI)	
									-SX	-SS
NPTF PORT / CODE 61 FLANGE HEAD										
12GHQ1	3/4-14	0.75	0.265	0.75	1.500	1.62	2.47	1.50	4.0	
16GHQ1	1-11 1/2	1.00	0.315	1.00	1.750	1.62	2.66	1.75	4.0	
20GHQ1	1 1/4-11 1/2	1.25	0.315	1.25	2.000	1.81	2.84	2.00	3.0	
24GHQ1	1 1/2-11 1/2	1.50	0.315	1.50	2.375	2.00	3.00	2.38	2.0	
32GHQ1	2-11 1/2	2.00	0.375	2.00	2.812	2.00	3.00	2.81	2.0	

G5HQ

TUBE FITTING PART #	T5 PORT THREAD UN-2B	SAE PORT DASH SIZE	FLANGE SIZE (in.)	C (in.)	D (in.)	F (in.)	H (in.)	L (in.)	R (in.)	Dynamic Pressure (x 1,000 PSI)	
										-SX	-SS
SAE PORT / CODE 61 FLANGE HEAD											
12G5HQ1	1 1/6-12	12	0.75	0.265	0.75	1.500	1.62	2.47	1.50	4.0	
16G5HQ1	1 5/16-12	15	1.00	0.315	1.00	1.750	1.62	2.66	1.75	3.0	
20G5HQ1	1 5/8-12	20	1.25	0.315	1.25	2.000	1.81	2.84	2.00	2.2	
24G5HQ1	1 7/8-12	24	1.50	0.315	1.50	2.375	2.00	3.00	2.38	2.5	
32G5HQ1	2 1/2-12	32	2.00	0.375	2.00	2.812	2.00	3.00	2.81	1.2	

Dimensions and pressures for reference only, subject to change.



WB1HQ1 / WB3HQ1 / WB5HQ1

Code 61 Weld Butt Flange
Connector, Pipe
Schedule 40, 80 or 160 Weld Butt /
Code 61 Flange Head

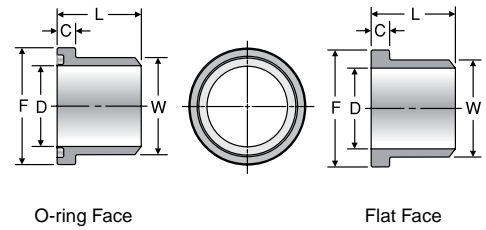


TABLE
OF
CONTENTS

VISUAL
INDEX

WELD BUTT FLANGE CONNECTION TYPE	TUBE FITTING PART #		PIPE SIZE (in.)	FLANGE SIZE (in.)	C (in.)	D (in.)	F (in.)	L (in.)	W (in.)	Dynamic Pressure (x 1,000 PSI)	
	O-RING FACE	FLAT FACE								-SX	-SS
SCHEDULE 40 WELD BUTT / CODE 61 FLANGE HEAD											
WB1HQ1 For Schedule 40 pipe	8WB1HQ1	8WB1HQ1N	1/2	0.50	0.265	0.622	1.188	1.06	0.840	5.3	
	12WB1HQ1	12WB1HQ1N	3/4	0.75	0.265	0.824	1.500	1.06	1.050	4.6	
	16WB1HQ1	16WB1HQ1N	1	1.00	0.315	1.049	1.750	1.25	1.315	4.0	
	20WB1HQ1	20WB1HQ1N	1 1/4	1.25	0.315	1.380	2.000	1.44	1.660	3.6	
	24WB1HQ1	24WB1HQ1N	1 1/2	1.50	0.315	1.610	2.375	1.75	1.900	3.0	
	32WB1HQ1	32WB1HQ1N	2	2.00	0.375	2.067	2.812	2.00	2.375	2.6	
	40WB1HQ1	40WB1HQ1N	2 1/2	2.50	0.375	2.469	3.312	2.31	2.875	2.6	
48WB1HQ1	48WB1HQ1N	3	3.00	0.375	3.068	4.000	2.32	3.500	2.3		
SCHEDULE 80 WELD BUTT / CODE 61 FLANGE HEAD											
WB3HQ1 For Schedule 80 pipe	8WB3HQ1	8WB3HQ1N	1/2	0.50	0.265	0.546	1.188	1.06	0.840	5.0	
	12WB3HQ1	12WB3HQ1N	3/4	0.75	0.265	0.742	1.500	1.06	1.050	3.5	
	16WB3HQ1	16WB3HQ1N	1	1.00	0.315	0.957	1.750	1.25	1.315	4.0	
	20WB3HQ1	20WB3HQ1N	1 1/4	1.25	0.315	1.278	2.000	1.44	1.660	3.5	
	24WB3HQ1	24WB3HQ1N	1 1/2	1.50	0.315	1.500	2.375	1.75	1.900	3.0	
	32WB3HQ1	32WB3HQ1N	2	2.00	0.375	1.939	2.812	2.00	2.375	3.0	
	40WB3HQ1	40WB3HQ1N	2 1/2	2.50	0.375	2.323	3.312	2.31	2.875	2.7	
48WB3HQ1	48WB3HQ1N	3	3.00	0.375	2.900	4.000	2.32	3.500	2.2		
SCHEDULE 160 WELD BUTT / CODE 61 FLANGE HEAD											
WB5HQ1 For Schedule 160 pipe	8WB5HQ1	8WB5HQ1N	1/2	0.50	0.265	0.464	1.188	1.06	0.840	5.0	
	12WB5HQ1	12WB5HQ1N	3/4	0.75	0.265	0.614	1.500	1.06	1.050	4.0	
	16WB5HQ1	16WB5HQ1N	1	1.00	0.315	0.815	1.750	1.25	1.315	4.5	
	20WB5HQ1	20WB5HQ1N	1 1/4	1.25	0.315	1.160	2.000	1.44	1.660	4.0	
	24WB5HQ1	24WB5HQ1N	1 1/2	1.50	0.315	1.337	2.375	1.75	1.900	3.0	
	32WB5HQ1	32WB5HQ1N	2	2.00	0.375	1.689	2.812	2.00	2.375	3.0	
	40WB5HQ1	40WB5HQ1N	2 1/2	2.50	0.375	2.125	3.312	2.31	2.875	2.5	
48WB5HQ1	48WB5HQ1N	3	3.00	0.375	2.624	4.000	2.32	3.500	2.0		

WB3HQ2 / WB5HQ2 / WB7HQ2

Code 62 Weld Butt Flange
Connector, Pipe
Schedule 80, 160 or
XXS Weld Butt / Code 62
Flange Head

WELD BUTT FLANGE CONNECTION TYPE	TUBE FITTING PART #		PIPE SIZE (in.)	FLANGE SIZE (in.)	C (in.)	D (in.)	F (in.)	L (in.)	W (in.)	Dynamic Pressure (x 1,000 PSI)	
	O-RING FACE	FLAT FACE								-SX	-SS
SCHEDULE 80 WELD BUTT / CODE 62 FLANGE HEAD											
WB3HQ2 For Schedule 80 pipe	12WB3HQ2	12WB3HQ2N	3/4	0.75	0.345	0.742	1.625	1.42	1.050	5.0	
	16WB3HQ2	16WB3HQ2N	1	1.00	0.375	0.957	1.875	1.61	1.315	4.5	
	20WB3HQ2	20WB3HQ2N	1 1/4	1.25	0.405	1.278	2.125	1.73	1.660	3.5	
	24WB3HQ2	24WB3HQ2N	1 1/2	1.50	0.495	1.500	2.500	2.17	1.900	3.0	
	32WB3HQ2	32WB3HQ2N	2	2.00	0.495	1.939	3.125	2.48	2.375	3.0	
SCHEDULE 160 WELD BUTT / CODE 62 FLANGE HEAD											
WB5HQ2 For Schedule 160 pipe	12WB5HQ2	12WB5HQ2N	3/4	0.75	0.345	0.614	1.625	1.42	1.050	6.0	
	16WB5HQ2	16WB5HQ2N	1	1.00	0.375	0.815	1.875	1.61	1.315	5.5	
	20WB5HQ2	20WB5HQ2N	1 1/4	1.25	0.405	1.160	2.125	1.73	1.660	5.0	
	24WB5HQ2	24WB5HQ2N	1 1/2	1.50	0.495	1.337	2.500	2.17	1.900	5.0	
	32WB5HQ2	32WB5HQ2N	2	2.00	0.495	1.689	3.125	2.48	2.375	4.5	
SCHEDULE XXS WELD BUTT / CODE 62 FLANGE HEAD											
WB7HQ2 For Schedule XXS pipe	12WB7HQ2	12WB7HQ2N	3/4	0.75	0.345	0.434	1.625	1.42	1.050	6.0	
	16WB7HQ2	16WB7HQ2N	1	1.00	0.375	0.599	1.875	1.61	1.315	6.0	
	20WB7HQ2	20WB7HQ2N	1 1/4	1.25	0.405	0.896	2.125	1.73	1.660	6.0	
	24WB7HQ2	24WB7HQ2N	1 1/2	1.50	0.495	1.100	2.500	2.17	1.900	6.0	
	32WB7HQ2	32WB7HQ2N	2	2.00	0.495	1.503	3.125	2.48	2.375	6.0	

Dimensions and pressures for reference only, subject to change.

G5Q

SAE Port Block Adapter
SAE Port / Code 61 or 62 Block Flange or Pad

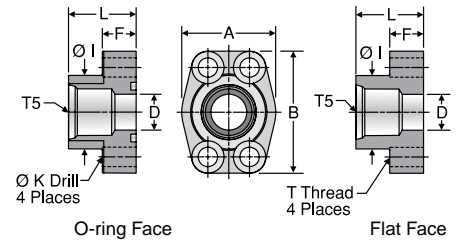


TABLE
OF
CONTENTS

VISUAL
INDEX

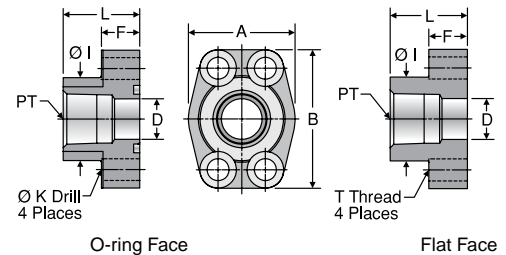
TUBE FITTING PART #		SAE PORT DASH SIZE	T5 STRAIGHT THREAD UN-2B	FLANGE SIZE (in.)	A (in.)	B (in.)	D (in.)	F (in.)	I (in.)	K DRILL DIA. (in.)	L (in.)	T THREAD UNC-2B	MOUNTING HARDWARE -SHCS	Dynamic Pressure (x 1,000 PSI)	
O-RING FACE	FLAT FACE													-SX	-SS ¹
SAE PORT / CODE 61 BLOCK FLANGE OR PAD															
8G5Q1B	8G5Q1P	8	3/4-16	0.50	1.81	2.13	0.50	0.63	1.25	0.344	1.42	5/16-18	5/16-18 x 1.25	5.0	
12G5Q1B	12G5Q1P	12	1 1/16-12	0.75	1.97	2.56	0.75	0.71	1.54	0.406	1.42	3/8-16	3/8-16 x 1.50	4.0	
16G5Q1B	16G5Q1P	16	1 5/16-12	1.00	2.17	2.75	1.00	0.71	1.81	0.406	1.50	3/8-16	3/8-16 x 1.50	3.5	
20G5Q1B	20G5Q1P	20	1 5/8-12	1.25	2.68	3.12	1.25	0.83	2.22	0.469	1.61	7/16-14	7/16-14 x 1.75	3.0	
24G5Q1B	24G5Q1P	24	1 7/8-12	1.50	3.07	3.66	1.50	0.98	2.50	0.531	1.77	1/2-13	1/2-13 x 1.75	2.5	
SAE PORT / CODE 62 BLOCK FLANGE OR PAD															
8G5Q2B	8G5Q2P	8	3/4-16	0.50	1.81	2.21	0.50	0.63	1.33	0.344	1.42	5/16-18	5/16-18 x 1.25	6.0	
12G5Q2B	12G5Q2P	12	1 1/16-12	0.75	2.17	2.80	0.75	0.83	1.65	0.406	1.38	3/8-16	3/8-16 x 1.50	5.5	
16G5Q2B	16G5Q2P	16	1 5/16-12	1.00	2.56	3.19	1.00	0.98	1.98	0.409	1.65	7/16-14	7/16-14 x 1.75	4.5	
20G5Q2B	20G5Q2P	20	1 5/8-12	1.25	3.07	3.75	1.25	1.06	2.36	0.531	1.77	1/2-13	1/2-13 x 1.75	3.0	
24G5Q2B	24G5Q2P	24	1 7/8-12	1.50	3.70	4.41	1.50	1.18	2.68	0.656	1.97	5/8-11	5/8-11 x 2.25	2.7	
32G5Q2B	32G5Q2P	32	2 1/2-12	2.00	4.50	5.28	2.00	1.46	3.38	0.781	2.56	3/4-10	3/4-10 x 2.75	2.0	

1) See page L38 for standard stainless steel sizes and dimensions.

To receive mounting hardware with flange, insert a "K" after the material designator. Mounting hardware kits are available for O-ring Face part numbers and include 4 bolts, 4 lock washers and an O-ring.

GQ

NPTF Port Block Adapter
NPTF Port / Code 61 or 62 Block Flange or Pad



TUBE FITTING PART #		PT PORT THREAD NPTF	FLANGE SIZE (in.)	A (in.)	B (in.)	D (in.)	F (in.)	I (in.)	K DRILL DIA. (in.)	L (in.)	T THREAD UNC-2B	MOUNTING HARDWARE -SHCS	Dynamic Pressure (x 1,000 PSI)		
O-RING FACE	FLAT FACE												-SX	-SS ¹	
NPTF PORT / CODE 61 BLOCK FLANGE OR PAD															
8GQ1B	8GQ1P	1/2 - 14	0.50	1.81	2.13	0.50	0.63	1.25	0.344	1.42	5/16-18	5/16-18 x 1.25	5.0		
12GQ1B	12GQ1P	3/4 - 14	0.75	1.97	2.56	0.75	0.71	1.54	0.406	1.42	3/8-16	3/8-16 x 1.50	4.5		
16GQ1B	16GQ1P	1 - 11 1/2	1.00	2.17	2.75	1.00	0.71	1.81	0.406	1.50	3/8-16	3/8-16 x 1.50	4.0		
20GQ1B	20GQ1P	1 1/4 - 11 1/2	1.25	2.68	3.12	1.25	0.83	2.22	0.469	1.61	7/16-14	7/16-14 x 1.75	3.5		
24GQ1B	24GQ1P	1 1/2 - 11 1/2	1.50	3.07	3.66	1.50	0.98	2.50	0.531	1.77	1/2-13	1/2-13 x 1.75	2.7		
32GQ1B	32GQ1P	2 - 11 1/2	2.00	3.54	4.00	2.00	0.98	3.12	0.531	1.77	1/2-13	1/2-13 x 1.75	2.2		
40GQ1B	40GQ1P	2 1/2 - 8	2.50	4.09	4.49	2.50	0.98	3.62	0.531	1.97	1/2-13	1/2-13 x 1.75	2.0		
48GQ1B	48GQ1P	3 1/2 - 8	3.00	4.88	5.28	3.00	1.06	4.47	0.656	1.97	5/8-11	5/8-11 x 2.00	1.1		
NPTF PORT / CODE 62 BLOCK FLANGE OR PAD															
8GQ2B	8GQ2P	1/2 - 14	0.50	1.81	2.21	0.50	0.63	1.33	0.344	1.42	5/16-18	5/16-18 x 1.25	6.0		
12GQ2B	12GQ2P	3/4 - 14	0.75	2.17	2.80	0.75	0.83	1.65	0.406	1.38	3/8-16	3/8-16 x 1.50	5.0		
16GQ2B	16GQ2P	1 - 11 1/2	1.00	2.56	3.19	1.00	0.98	1.98	0.469	1.65	7/16-14	7/16-14 x 1.75	4.0		
20GQ2B	20GQ2P	1 1/4 - 11 1/2	1.25	3.07	3.75	1.25	1.06	2.36	0.531	1.77	1/2-13	1/2-13 x 1.75	3.5		
24GQ2B	24GQ2P	1 1/2 - 11 1/2	1.50	3.70	4.41	1.50	1.18	2.68	0.656	1.97	5/8-11	5/8-11 x 2.25	3.0		
32GQ2B	32GQ2P	2 - 11 1/2	2.00	4.50	5.28	2.00	1.46	3.38	0.781	2.56	3/4-10	3/4-10 x 2.75	2.5		

1) See page L38 for standard stainless steel sizes and dimensions.

To receive mounting hardware with flange, insert a "K" after the material designator. Mounting hardware kits are available for O-ring Face part numbers and include 4 bolts, 4 lock washers and an O-ring.

Dimensions and pressures for reference only, subject to change.



G4Q

BSPP Port Block Adapter
BSPP Port / Code 61 or 62
Block Flange or Pad

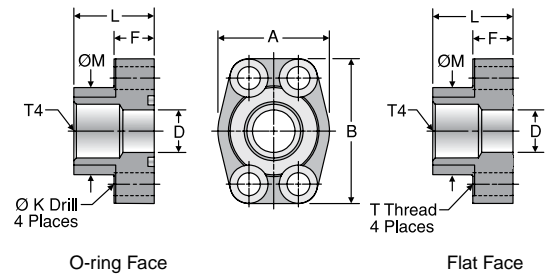


TABLE
OF
CONTENTS

VISUAL
INDEX

TUBE FITTING PART #		T4 THREAD BSPP	FLANGE SIZE (in.)	A (in.)	B (in.)	D (in.)	F (in.)	K DRILL DIA. (in.)	L (in.)	M (in.)	T THREAD UNC-2B	MOUNTING HARDWARE SHCS	Dynamic Pressure (x 1,000 PSI)	
O-RING FACE	FLAT FACE												SX	SS
BSPP PORT / CODE 61 BLOCK FLANGE OR PAD														
8G4Q1B	8G4Q1P	1/2-14	0.50	1.81	2.13	0.500	0.63	0.344	1.42	1.25	5/16-18	5/16-18 x 1.25	5.0	
12G4Q1B	12G4Q1P	3/4-14	0.75	1.97	2.56	0.750	0.71	0.406	1.42	1.54	3/8-16	3/8-16 x 1.50	4.0	
16G4Q1B	16G4Q1P	1-11	1.00	2.17	2.75	1.000	0.71	0.406	1.50	1.81	3/8-16	3/8-16 x 1.50	3.0	
20G4Q1B	20G4Q1P	1 1/4-11	1.25	2.68	3.12	1.250	0.83	0.469	1.61	2.22	7/16-14	7/16-14 x 1.75	2.5	
24G4Q1B	24G4Q1P	1 1/2-11	1.50	3.07	3.66	1.500	0.98	0.531	1.77	2.50	1/2-13	1/2-13 x 1.75	2.2	
32G4Q1B	32G4Q1P	2-11	2.00	3.54	4.00	2.000	0.98	0.531	1.77	3.12	1/2-13	1/2-13 x 1.75	1.7	
BSPP PORT / CODE 62 BLOCK FLANGE OR PAD														
8G4Q2B	8G4Q2P	1/2-14	0.50	1.81	2.21	0.500	0.63	0.344	1.42	1.33	5/16-18	5/16-18 x 1.25	6.0	
12G4Q2B	12G4Q2P	3/4-14	0.75	2.17	2.80	0.750	0.83	0.406	1.38	1.65	3/8-16	3/8-16 x 1.50	5.0	
16G4Q2B	16G4Q2P	1-11	1.00	2.56	3.19	1.000	0.98	0.469	1.65	1.98	7/16-14	7/16-14 x 1.75	4.0	
20G4Q2B	20G4Q2P	1 1/4-11	1.25	3.07	3.75	1.250	1.06	0.531	1.77	2.36	1/2-13	1/2-13 x 1.75	3.0	
24G4Q2B	24G4Q2P	1 1/2-11	1.50	3.70	4.41	1.500	1.18	0.656	1.97	2.68	5/8-11	5/8-11 x 2.25	2.5	
32G4Q2B	32G4Q2P	2-11	2.00	4.50	5.28	2.000	1.46	0.781	2.56	3.35	3/4-10	3/4-10 x 2.75	2.0	

To receive mounting hardware with flange, insert a "K" after the material designator. Mounting hardware kits are available for O-ring Face part numbers and include 4 bolts, 4 lock washers and an O-ring.

L

Dimensions and pressures for reference only, subject to change.

W5Q

Flat Weld Socket Block Connector, Pipe
 Flat Weld Socket, Pipe / Code 61 or 62
 Block Flange or Pad

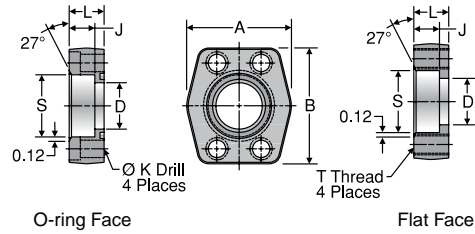


TABLE
 OF
 CONTENTS

VISUAL
 INDEX

TUBE FITTING PART #		PIPE SIZE	FLANGE SIZE	A	B	D	J	K DRILL DIA.	L	S	T THREAD	MOUNTING HARDWARE	Dynamic Pressure (x 1,000 PSI)	
O-RING FACE	FLAT FACE	(in.)	(in.)	(in.)	(in.)	(in.)	(in.)	(in.)	(in.)	(in.)	UNC-2B	SHCS	-SX	-SS ¹
FLAT WELD SOCKET, PIPE / CODE 61 BLOCK FLANGE OR PAD														
8W5Q1B	8W5Q1P	1/2	0.50	1.813	2.125	0.500	0.560	0.344	0.750	0.855	5/16-18	5/16-18 x 1.50	5.0	
12W5Q1B	12W5Q1P	3/4	0.75	2.063	2.563	0.750	0.560	0.406	0.750	1.062	3/8-16	3/8-16 x 1.50	5.0	
16W5Q1B	16W5Q1P	1	1.00	2.313	2.750	1.000	0.630	0.406	0.880	1.326	3/8-16	3/8-16 x 1.75	5.0	
20W5Q1B	20W5Q1P	1 1/4	1.25	2.875	3.125	1.250	0.690	0.469	0.940	1.672	7/16-14	7/16-14 x 1.75	4.0	
24W5Q1B	24W5Q1P	1 1/2	1.50	3.250	3.688	1.500	0.750	0.531	1.190	1.922	1/2-13	1/2-13 x 2.25	3.0	
32W5Q1B	32W5Q1P	2	2.00	3.813	4.000	2.000	0.875	0.531	1.380	2.406	1/2-13	1/2-13 x 2.50	3.0	
40W5Q1B	40W5Q1P	2 1/2	2.50	4.281	4.500	2.500	1.000	0.531	1.750	2.906	1/2-13	1/2-13 x 2.75	2.5	
48W5Q1B	48W5Q1P	3	3.00	5.156	5.313	3.000	1.250	0.656	2.120	3.547	5/8-11	5/8-11 x 3.50	2.0	
56W5Q1B	56W5Q1P	3 1/2	3.50	5.500	6.000	3.500	1.190	0.656	1.440	4.047	5/8-11	5/8-11 x 2.75	0.5	
64W5Q1B	64W5Q1P	4	4.00	6.000	6.380	4.000	1.250	0.656	1.500	4.578	5/8-11	5/8-11 x 2.75	0.5	
80W5Q1B	80W5Q1P	5	5.00	7.120	7.250	4.500	1.380	0.656	1.750	5.641	5/8-11	5/8-11 x 3.00	0.5	
FLAT WELD SOCKET, PIPE / CODE 62 BLOCK FLANGE OR PAD														
8W5Q2B	8W5Q2P	1/2	0.50	1.940	2.300	0.500	0.560	0.344	1.250	0.855	5/16-18	5/16-18 x 2.00	6.0	
12W5Q2B	12W5Q2P	3/4	0.75	2.500	2.950	0.750	0.560	0.406	1.250	1.062	3/8-16	3/8-16 x 2.00	6.0	
16W5Q2B	16W5Q2P	1	1.00	2.750	3.190	1.000	0.630	0.469	1.500	1.326	7/16-14	7/16-14 x 2.50	6.0	
20W5Q2B	20W5Q2P	1 1/4	1.25	3.060	3.750	1.250	0.690	0.531	1.500	1.672	1/2-13	1/2-13 x 2.50	6.0	
24W5Q2B	24W5Q2P	1 1/2	1.50	3.750	4.440	1.500	0.750	0.656	1.750	1.922	5/8-11	5/8-11 x 3.00	6.0	
32W5Q2B	32W5Q2P	2	2.00	4.500	5.250	2.000	0.875	0.781	1.750	2.406	3/4-10	3/4-10 x 3.00	6.0	
40W5Q2B ²	40W5Q2P ²	2 1/2	2.50	5.870	6.870	2.500	1.000	0.906	2.060	2.906	7/8-9	7/8-9 x 3.50	3.0	
48W5Q2B ²	48W5Q2P ²	3	3.00	7.000	8.500	3.000	1.250	1.156	2.620	3.547	1 1/8-7	1 1/8-7 x 4.50	3.0	

- 1) See page L39 for standard stainless steel sizes and dimensions.
 - 2) Not covered in SAE J518. Bolt hole centerline dimensions are: 2.312" x 4.875" for 40W5Q2 and 2.812" x 6.000" for 48W5Q2.
- To receive mounting hardware with flange, insert a "K" after the material designator. Mounting hardware kits are available for O-ring Face part numbers and include 4 bolts, 4 lock washers and an O-ring.

Dimensions and pressures for reference only, subject to change.



W4Q

Flat Weld Socket Block Connector, Tube
Flat Weld Socket, Tube / Code 61 or 62
Block Flange or Pad

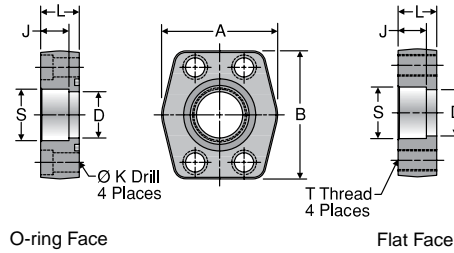


TABLE
OF
CONTENTS

VISUAL
INDEX

TUBE FITTING PART #		TUBE O.D. (in.)	FLANGE SIZE (in.)	A (in.)	B (in.)	D (in.)	J (in.)	K DRILL DIA. (in.)	L (in.)	S (in.)	T THREAD UNC-2B	MOUNTING HARDWARE SHCS	Dynamic Pressure (x 1,000 PSI)	
O-RING FACE	FLAT FACE												-SX	-SS
FLAT WELD SOCKET, TUBE / CODE 61 BLOCK FLANGE OR PAD														
12W4Q1B	12W4Q1P	3/4	0.75	2.06	2.56	0.625	0.560	0.406	0.750	0.752	3/8-16	3/8-16 x 1.50	5.0	
16-12W4Q1B	16-12W4Q1P	1	0.75	2.06	2.56	0.750	0.560	0.406	0.750	1.002	3/8-16	3/8-16 x 1.50	5.0	
16W4Q1B	16W4Q1P	1	1.00	2.31	2.75	0.875	0.630	0.406	0.880	1.002	3/8-16	3/8-16 x 1.75	5.0	
20-16W4Q1B	20-16W4Q1P	1 1/4	1.00	2.31	2.75	1.000	0.630	0.406	0.880	1.252	3/8-16	3/8-16 x 1.75	5.0	
20W4Q1B	20W4Q1P	1 1/4	1.25	2.88	3.12	1.125	0.690	0.469	0.940	1.252	7/16-14	7/16-14 x 1.75	4.0	
24-20W4Q1B	24-20W4Q1P	1 1/2	1.25	2.88	3.12	1.250	0.690	0.469	0.940	1.502	7/16-14	7/16-14 x 1.75	4.0	
24W4Q1B	24W4Q1P	1 1/2	1.50	3.25	3.69	1.375	0.750	0.531	1.190	1.502	1/2-13	1/2-13 x 2.25	3.0	
28-24W4Q1B	28-24W4Q1P	1 3/4	1.50	3.25	3.69	1.500	0.750	0.531	1.190	1.752	1/2-13	1/2-13 x 2.25	3.0	
32W4Q1B	32W4Q1P	2	2.00	3.81	4.00	1.875	0.875	0.531	1.375	2.002	1/2-13	1/2-13 x 2.50	3.0	
36-32W4Q1B	36-32W4Q1P	2 1/4	2.00	3.81	4.00	2.000	0.875	0.531	1.375	2.252	1/2-13	1/2-13 x 2.50	3.0	
FLAT WELD SOCKET, TUBE / CODE 62 BLOCK FLANGE OR PAD														
12W4Q2B	12W4Q2P	3/4	0.75	2.38	2.81	0.625	0.560	0.406	1.250	0.752	3/8-16	3/8-16 x 2.00	6.0	
16-12W4Q2B	16-12W4Q2P	1	0.75	2.38	2.81	0.750	0.560	0.406	1.250	1.002	3/8-16	3/8-16 x 2.00	6.0	
16W4Q2B	16W4Q2P	1	1.00	2.75	3.19	0.875	0.630	0.469	1.500	1.002	7/16-14	7/16-14 x 2.25	6.0	
20-16W4Q2B	20-16W4Q2P	1 1/4	1.00	2.75	3.19	1.000	0.630	0.469	1.500	1.252	7/16-14	7/16-14 x 2.25	6.0	
20W4Q2B	20W4Q2P	1 1/4	1.25	3.06	3.75	1.125	0.690	0.531	1.500	1.252	1/2-13	1/2-13 x 2.50	6.0	
24-20W4Q2B	24-20W4Q2P	1 1/5	1.25	3.06	3.75	1.250	0.690	0.531	1.500	1.502	1/2-13	1/2-13 x 2.50	6.0	
24W4Q2B	24W4Q2P	1 1/2	1.50	3.75	4.44	1.375	0.750	0.656	1.750	1.502	5/8-11	5/8-11 x 2.75	6.0	
28-24W4Q2B	28-24W4Q2P	1 3/4	1.50	3.75	4.44	1.500	0.750	0.656	1.750	1.752	5/8-11	5/8-11 x 2.75	6.0	
32W4Q2B1 ¹	32W4Q2P1 ¹	2	2.00	4.50	5.25	1.875	0.875	0.781	1.750	2.002	3/4-10	3/4-10 x 3.00	6.0	
36-32W4Q2B1 ¹	36-32W4Q2P1 ¹	2 1/4	2.00	4.50	5.25	2.000	0.875	0.781	1.750	2.252	3/4-10	3/4-10 x 3.00	6.0	

1) Not covered in SAE J518.

To receive mounting hardware with flange, insert a "K" after the material designator. Mounting hardware kits are available for O-ring Face part numbers and include 4 bolts, 4 lock washers and an O-ring.

Dimensions and pressures for reference only, subject to change.



W7Q

Extended Weld Socket Block Connector, Pipe
 Deep Weld Socket, Pipe / Code 61 or 62
 Block Flange or Pad

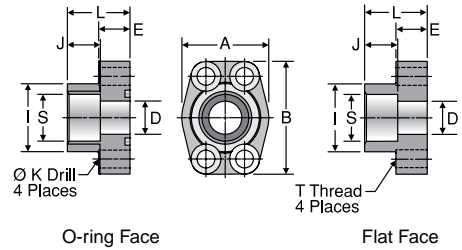


TABLE
 OF
 CONTENTS

VISUAL
 INDEX

TUBE FITTING PART #		PIPE SIZE (in.)	FLANGE SIZE (in.)	A (in.)	B (in.)	D (in.)	E (in.)	I (in.)	J (in.)	K DRILL DIA. (in.)	L (in.)	S (in.)	T THREAD UNC-2B	MOUNTING HARDWARE SHCS	Dynamic Pressure (x 1,000 PSI)	
O-RING FACE	FLAT FACE														-SX	-SS
EXTENDED WELD SOCKET, PIPE / CODE 61 BLOCK FLANGE OR PAD																
12W7Q1B	12W7Q1P	3/4	0.75	1.97	2.56	0.75	0.710	1.54	0.750	0.406	1.420	1.062	3/8-16	3/8-16 x 1.50	5.0	
16W7Q1B	16W7Q1P	1	1.00	2.17	2.75	1.00	0.710	1.81	0.750	0.406	1.500	1.328	3/8-16	3/8-16 x 1.50	4.5	
20W7Q1B	20W7Q1P	1 1/4	1.25	2.68	3.12	1.25	0.830	2.22	0.870	0.469	1.610	1.672	7/16-14	7/16-14 x 1.75	2.7	
24W7Q1B	24W7Q1P	1 1/2	1.50	3.07	3.66	1.50	0.980	2.50	0.940	0.531	1.770	1.922	1/2-13	1/2-13 x 1.75	3.0	
32W7Q1B	32W7Q1P	2	2.00	3.54	4.00	2.00	0.980	3.12	1.020	0.531	1.770	2.406	1/2-13	1/2-13 x 1.75	2.5	
40W7Q1B	40W7Q1P	2 1/2	2.50	4.09	4.49	2.50	0.980	3.62	1.180	0.531	1.970	2.906	1/2-13	1/2-13 x 1.75	2.2	
EXTENDED WELD SOCKET, PIPE / C ODE 62 BLOCK FLANGE OR PAD																
12W7Q2B	12W7Q2P	3/4	0.75	2.17	2.80	0.75	0.830	1.65	0.870	0.406	1.380	1.062	3/8-16	3/8-16 x 1.50	6.0	
16W7Q2B	16W7Q2P	1	1.00	2.56	3.19	1.00	0.980	1.98	0.870	0.469	1.650	1.328	7/16-14	7/16-14 x 1.75	6.0	
20W7Q2B	20W7Q2P	1 1/4	1.25	3.07	3.75	1.25	1.060	2.36	0.980	0.531	1.770	1.672	1/2-13	1/2-13 x 1.75	5.5	
24W7Q2B	24W7Q2P	1 1/2	1.50	3.7	4.41	1.50	1.180	2.68	1.100	0.656	1.970	1.922	5/8-11	5/8-11 x 2.25	5.5	
32W7Q2B	32W7Q2P	2	2.00	4.5	5.28	2.00	1.460	3.35	0.940	0.781	2.560	2.406	3/4-10	3/4-10 x 2.75	5.0	

To receive mounting hardware with flange, insert a "K" after the material designator. Mounting hardware kits are available for O-ring Face part numbers and include 4 bolts, 4 lock washers and an O-ring.

Dimensions and pressures for reference only, subject to change.



W6Q

Extended Weld Socket Block Connector, Tube
Deep Weld Socket, Tube / Code 61 or 62
Block Flange or Pad

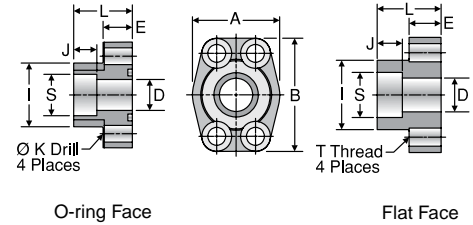


TABLE OF CONTENTS

VISUAL INDEX

TUBE FITTING PART #		TUBE O.D. (in.)	FLANGE SIZE (in.)	A (in.)	B (in.)	D (in.)	E (in.)	I (in.)	J (in.)	K DRILL DIA. (in.)	L (in.)	S (in.)	T THREAD UNC-2B	MOUNTING HARDWARE SHCS	Dynamic Pressure (x 1,000 PSI)	
O-RING FACE	FLAT FACE														-SX	-SS
EXTENDED WELD SOCKET, TUBE / CODE 61 BLOCK FLANGE OR PAD																
12W6Q1B	12W6Q1P	3/4	0.75	1.97	2.56	0.625	0.71	1.54	0.560	0.406	1.420	0.752	3/8-16	3/8-16 x 1.50	5.0	
16-12W6Q1B	16-12W6Q1P	1	0.75	1.97	2.56	0.750	0.71	1.54	0.560	0.406	1.420	1.002	3/8-16	3/8-16 x 1.50	5.0	
16W6Q1B	16W6Q1P	1	1.00	2.17	2.75	0.875	0.71	1.81	0.630	0.406	1.500	1.002	3/8-16	3/8-16 x 1.50	5.0	
20-16W6Q1B	20-16W6Q1P	1 1/4	1.00	2.17	2.75	1.000	0.71	1.81	0.630	0.406	1.500	1.252	3/8-16	3/8-16 x 1.50	5.0	
20W6Q1B	20W6Q1P	1 1/4	1.25	2.68	3.12	1.125	0.83	2.22	0.690	0.469	1.610	1.252	7/16-14	7/16-14 x 1.75	4.0	
24-20W6Q1B	24-20W6Q1P	1 1/2	1.25	2.68	3.12	1.250	0.83	2.22	0.690	0.469	1.610	1.502	7/16-14	7/16-14 x 1.75	4.0	
24W6Q1B	24W6Q1P	1 1/2	1.50	3.07	3.66	1.375	0.98	2.50	0.750	0.531	1.770	1.502	1/2-13	1/2-13 x 1.75	3.0	
28-24W6Q1B	28-24W6Q1P	1 3/4	1.50	3.07	3.66	1.500	0.98	2.50	0.750	0.531	1.770	1.752	1/2-13	1/2-13 x 1.75	3.0	
32W6Q1B	32W6Q1P	2	2.00	3.54	4.00	1.875	0.98	3.12	0.870	0.531	1.770	2.002	1/2-13	1/2-13 x 1.75	3.0	
36-32W6Q1B	36-32W6Q1P	2 1/4	2.00	3.54	4.00	2.000	0.98	3.12	0.870	0.531	1.770	2.252	1/2-13	1/2-13 x 1.75	3.0	
40W6Q1B	40W6Q1P	2 1/2	2.50	4.09	4.49	2.375	0.98	3.62	1.000	0.531	1.970	2.502	1/2-13	1/2-13 x 1.75	2.5	
44-40W6Q1B	44-40W6Q1P	2 3/4	2.50	4.09	4.49	2.500	0.98	3.62	1.000	0.531	1.970	2.752	1/2-13	1/2-13 x 1.75	2.2	
EXTENDED WELD SOCKET, TUBE / CODE 62 BLOCK FLANGE OR PAD																
12W6Q2B	12W6Q2P	3/4	0.75	2.17	2.80	0.625	0.83	1.65	0.560	0.406	1.380	0.752	3/8-16	3/8-16 x 1.50	6.0	
16-12W6Q2B	16-12W6Q2P	1	0.75	2.17	2.80	0.750	0.83	1.65	0.560	0.406	1.380	1.002	3/8-16	3/8-16 x 1.50	6.0	
16W6Q2B	16W6Q2P	1	1.00	2.56	3.19	0.875	0.98	1.98	0.630	0.469	1.650	1.002	7/16-14	7/16-14 x 1.75	6.0	
20-16W6Q2B	20-16W6Q2P	1 1/4	1.00	2.56	3.19	1.000	0.98	1.98	0.630	0.469	1.650	1.252	7/16-14	7/16-14 x 1.75	6.0	
20W6Q2B	20W6Q2P	1 1/4	1.25	3.07	3.75	1.125	1.06	2.36	0.690	0.531	1.770	1.252	1/2-13	1/2-13 x 1.75	6.0	
24-20W6Q2B	24-20W6Q2P	1 1/2	1.25	3.07	3.75	1.250	1.06	2.36	0.690	0.531	1.770	1.502	1/2-13	1/2-13 x 1.75	6.0	
24W6Q2B	24W6Q2P	1 1/2	1.50	3.70	4.41	1.375	1.18	2.68	0.750	0.656	1.970	1.502	5/8-11	5/8-11 x 2.25	6.0	
28-24W6Q2B	28-24W6Q2P	1 3/4	1.50	3.70	4.41	1.500	1.18	2.68	0.750	0.656	1.970	1.752	5/8-11	5/8-11 x 2.25	6.0	
32W6Q2B	32W6Q2P	2	2.00	4.50	5.28	1.875	1.46	3.35	0.870	0.781	2.560	2.002	3/4-10	3/4-10 x 2.75	6.0	
36-32W6Q2B	36-32W6Q2P	2 1/4	2.00	4.50	5.28	2.000	1.46	3.35	0.870	0.781	2.560	2.252	3/4-10	3/4-10 x 2.75	5.5	

To receive mounting hardware with flange, insert a "K" after the material designator. Mounting hardware kits are available for O-ring Face part numbers and include 4 bolts, 4 lock washers and an O-ring.

Dimensions and pressures for reference only, subject to change.



WB1Q1 / WB3Q1 / WB5Q1

Code 61 Weld Butt Block Connector, Pipe
Schedule 40, 80 or 160 Weld Butt /
Code 61 Block Flange or Pad

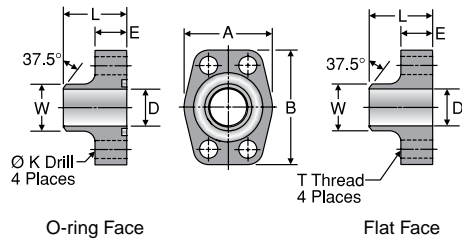


TABLE
OF
CONTENTS

VISUAL
INDEX

WELD BUTT BLOCK CONNECTION TYPE	TUBE FITTING PART #		PIPE SIZE (in.)	FLANGE SIZE (in.)	A (in.)	B (in.)	D PIPE I.D. (in.)	E (in.)	K DRILL DIA. (in.)	L (in.)	T THREAD UNC-2B	W PIPE O.D. (in.)	MOUNTING HARDWARE		Dynamic Pressure (x 1,000 PSI)	
	O-RING FACE	FLAT FACE											SHCS	-SX	-SS	
SCHEDULE 40 WELD BUTT / CODE 61 BLOCK FLANGE OR PAD																
WB1Q1 For Schedule 40 pipe	12WB1Q1B	12WB1Q1P	3/4	0.75	1.97	2.56	0.826	0.710	0.406	1.420	3/8-16	1.050	3/8-16 x 1.50	3.5		
	16WB1Q1B	16WB1Q1P	1	1.00	2.17	2.75	1.051	0.710	0.406	1.500	3/8-16	1.315	3/8-16 x 1.50	3.0		
	20WB1Q1B	20WB1Q1P	1 1/4	1.25	2.68	3.12	1.382	0.830	0.469	1.610	7/16-14	1.660	7/16-14 x 1.75	2.7		
	24WB1Q1B	24WB1Q1P	1 1/2	1.50	3.07	3.66	1.612	0.980	0.531	1.730	1/2-13	1.900	1/2-13 x 1.75	2.2		
	32WB1Q1B	32WB1Q1P	2	2.00	3.54	4.00	2.069	0.980	0.531	1.770	1/2-13	2.375	1/2-13 x 1.75	2.0		
	40WB1Q1B	40WB1Q1P	2 1/2	2.50	4.09	4.49	2.471	0.980	0.531	1.970	1/2-13	2.875	1/2-13 x 1.75	2.0		
	48WB1Q1B	48WB1Q1P	3	3.00	4.88	5.28	3.070	1.060	0.656	1.970	5/8-11	3.500	5/8-11 x 2.00	1.7		
SCHEDULE 80 WELD BUTT / CODE 61 BLOCK FLANGE OR PAD																
WB3Q1 For Schedule 80 pipe	12WB3Q1B	12WB3Q1P	3/4	0.75	1.97	2.56	0.744	0.710	0.406	1.420	3/8-16	1.050	3/8-16 x 1.50	5.0		
	16WB3Q1B	16WB3Q1P	1	1.00	2.17	2.75	0.959	0.710	0.406	1.500	3/8-16	1.315	3/8-16 x 1.50	4.5		
	20WB3Q1B	20WB3Q1P	1 1/4	1.25	2.68	3.12	1.280	0.830	0.469	1.610	7/16-14	1.660	7/16-14 x 1.75	4.0		
	24WB3Q1B	24WB3Q1P	1 1/2	1.50	3.07	3.66	1.502	0.980	0.531	1.730	1/2-13	1.900	1/2-13 x 1.75	3.0		
	32WB3Q1B	32WB3Q1P	2	2.00	3.54	4.00	1.941	0.980	0.531	1.770	1/2-13	2.375	1/2-13 x 1.75	3.0		
	40WB3Q1B	40WB3Q1P	2 1/2	2.50	4.09	4.49	2.325	0.980	0.531	1.970	1/2-13	2.875	1/2-13 x 1.75	2.5		
	48WB3Q1B	48WB3Q1P	3	3.00	4.88	5.28	2.902	1.060	0.656	1.970	5/8-11	3.500	5/8-11 x 2.00	2.0		
SCHEDULE 160 WELD BUTT / CODE 61 BLOCK FLANGE OR PAD																
WB5Q1 For Schedule 160 pipe	12WB5Q1B	12WB5Q1P	3/4	0.75	1.97	2.56	0.614	0.710	0.406	1.420	3/8-16	1.050	3/8-16 x 1.50	5.0		
	16WB5Q1B	16WB5Q1P	1	1.00	2.17	2.75	0.817	0.710	0.406	1.500	3/8-16	1.315	3/8-16 x 1.50	5.0		
	20WB5Q1B	20WB5Q1P	1 1/4	1.25	2.68	3.12	1.162	0.830	0.469	1.610	7/16-14	1.660	7/16-14 x 1.75	4.0		
	24WB5Q1B	24WB5Q1P	1 1/2	1.50	3.07	3.66	1.340	0.980	0.531	1.730	1/2-13	1.900	1/2-13 x 1.75	3.0		
	32WB5Q1B	32WB5Q1P	2	2.00	3.54	4.00	1.689	0.980	0.531	1.770	1/2-13	2.375	1/2-13 x 1.75	3.0		
	40WB5Q1B	40WB5Q1P	2 1/2	2.50	4.09	4.49	2.127	0.980	0.531	1.970	1/2-13	2.875	1/2-13 x 1.75	2.5		
	48WB5Q1B	48WB5Q1P	3	3.00	4.88	5.28	2.626	1.060	0.656	1.970	5/8-11	3.500	5/8-11 x 2.00	2.0		

To receive mounting hardware with flange, insert a "K" after the material designator. Mounting hardware kits are available for O-ring Face part numbers and include 4 bolts, 4 lock washers and an O-ring.

Dimensions and pressures for reference only, subject to change.

WB3Q2 / WB5Q2 / WB7Q2

Code 62 Weld Butt Block Connector, Pipe
Schedule 80, 160 or XXS Weld Butt /
Code 62 Block Flange or Pad

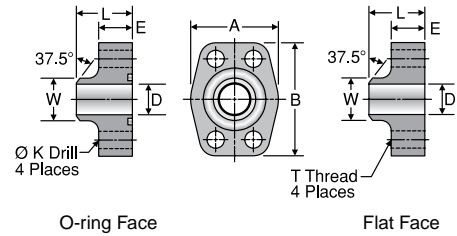


TABLE OF CONTENTS

VISUAL INDEX

WELD BUTT CONNECTION TYPE	TUBE FITTING PART #		PIPE SIZE (in.)	FLANGE SIZE (in.)	A (in.)	B (in.)	D PIPE I.D. (in.)	E (in.)	K DRILL DIA. (in.)	L (in.)	T THREAD UNC-2B	W PIPE O.D. (in.)	MOUNTING HARDWARE SHCS	Dynamic Pressure (x 1,000 PSI)	
	O-RING FACE	FLAT FACE												-SX	-SS
SCHEDULE 80 WELD BUTT / CODE 62 BLOCK FLANGE OR PAD															
WB3Q2 For Schedule 80 pipe	12WB3Q2B	12WB3Q2P	3/4	0.75	2.17	2.80	0.744	0.83	0.406	1.38	3/8-16	1.050	3/8-16 x 1.50	5.0	
	16WB3Q2B	16WB3Q2P	1	1.00	2.56	3.19	0.959	0.83	0.469	1.61	7/16-14	1.315	7/16-14 x 1.75	4.5	
	20WB3Q2B	20WB3Q2P	1 1/4	1.25	3.07	3.75	1.280	0.98	0.531	1.73	1/2-13	1.660	1/2-13 x 1.75	3.5	
	24WB3Q2B	24WB3Q2P	1 1/2	1.50	3.70	4.41	1.502	1.18	0.656	2.17	5/8-11	1.900	5/8-11 x 2.25	3.0	
	32WB3Q2B	32WB3Q2P	2	2.00	4.50	5.28	1.941	1.46	0.781	2.56	3/4-10	2.375	3/4-10 x 2.75	3.0	
SCHEDULE 160 WELD BUTT / CODE 62 BLOCK FLANGE OR PAD															
WB5Q2 For Schedule 160 pipe	12WB5Q2B	12WB5Q2P	3/4	0.75	2.17	2.80	0.614	0.83	0.406	1.38	3/8-16	1.050	3/8-16 x 1.50	6.0	
	16WB5Q2B	16WB5Q2P	1	1.00	2.56	3.19	0.817	0.83	0.469	1.61	7/16-14	1.315	7/16-14 x 1.75	6.0	
	20WB5Q2B	20WB5Q2P	1 1/4	1.25	3.07	3.75	1.162	0.98	0.531	1.73	1/2-13	1.660	1/2-13 x 1.75	5.0	
	24WB5Q2B	24WB5Q2P	1 1/2	1.50	3.70	4.41	1.340	1.18	0.656	2.17	5/8-11	1.900	5/8-11 x 2.25	5.0	
	32WB5Q2B	32WB5Q2P	2	2.00	4.50	5.28	1.689	1.46	0.781	2.56	3/4-10	2.375	3/4-10 x 2.75	6.0	
SCHEDULE XXS WELD BUTT / CODE 62 BLOCK FLANGE OR PAD															
WB7Q2 For Schedule XXS pipe	12WB7Q2B	12WB7Q2P	3/4	0.75	2.17	2.80	0.436	0.83	0.406	1.38	3/8-16	1.050	3/8-16 x 1.50	6.0	
	16WB7Q2B	16WB7Q2P	1	1.00	2.56	3.19	0.601	0.83	0.469	1.61	7/16-14	1.315	7/16-14 x 1.75	6.0	
	20WB7Q2B	20WB7Q2P	1 1/4	1.25	3.07	3.75	0.898	0.98	0.531	1.73	1/2-13	1.660	1/2-13 x 1.75	6.0	
	24WB7Q2B	24WB7Q2P	1 1/2	1.50	3.70	4.41	1.102	1.18	0.656	2.17	5/8-11	1.900	5/8-11 x 2.25	6.0	
	32WB7Q2B	32WB7Q2P	2	2.00	4.50	5.28	1.505	1.46	0.781	2.56	3/4-10	2.375	3/4-10 x 2.75	6.0	

1) SAE J518 does not cover these sizes in Code 62.

To receive mounting hardware with flange, insert a "K" after the material designator. Mounting hardware kits are available for O-ring Face part numbers and include 4 bolts, 4 lock washers and an O-ring.



Dimensions and pressures for reference only, subject to change.

AS3 / AS6

SAE-Flange / Weld Butt

For metric tube welded connection

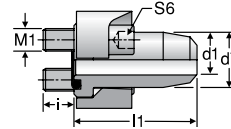


TABLE
OF
CONTENTS

VISUAL
INDEX

TUBE FITTING PART #	SIZE (in.)	TUBE O.D. x WALL THICKNESS (mm)	WORKING PRESSURE (bar)	d1 (mm)	d7 (mm)	l (mm)	l1 (mm)	S6 (mm)	WELD NIPPLE BODY	FROM STOCK CF	71
SAE FLANGE CONNECTION – CODE 61 – STANDARD SERIES											
AS32/15X2	1/2	15 x 2	200	11	23.9	11.5	38	6	AS32/15X2X		
AS32/16X3	1/2	16 x 3	220	10	23.9	11.5	38	6	AS32/16X3X		
AS33/18X1.5	3/4	18 x 1.5	130	15	31.8	15.5	50	8	AS33/18X1.5X		
AS33/22X2	3/4	22 x 2	140	18	31.8	15.5	50	8	AS33/22X2X		
AS33/20X3	3/4	20 x 3	220	14	31.8	15.5	50	8	AS33/20X3X		
AS33/25X4	3/4	25 x 4	220	17	31.8	15.5	50	8	AS33/25X4X		
AS34/28X2	1	28 x 2	115	24	38	13.5	50	8	AS34/28X2X		
AS34/30X4.5	1	30 x 4.5	220	21	38	13.5	50	8	AS34/30X4.5X		
AS35/35X2	1 1/4	35 x 2	90	31	43	18.5	55	8	AS35/35X2X		
AS35/25X3	1 1/4	25 x 3	175	19	43	18.5	55	8	AS35/25X3X		
AS35/30X4	1 1/4	30 x 4	175	22	43	18.5	55	8	AS35/30X4X		
AS35/38X5	1 1/4	38 x 5	175	28	43	18.5	55	8	AS35/38X5X		
AS36/42X3	1 1/2	42 x 3	115	36	50	18.5	57	10	AS36/42X3X		
AS36/38X4	1 1/2	38 x 4	130	30	50	18.5	57	10	AS36/38X4X		
AS38/50X6	2	50 x 6	130	38	62	24	62	12	AS38/50X6X		
AS38/65X8	2	65 x 8	130	49	65	24	62	12	AS38/65X8X		
SAE FLANGE CONNECTION – CODE 62 – HIGH PRESSURE SERIES											
AS62/16X3	1/2	16 x 3	260	10	23.9	13.5	41	6	AS62/16X3X		
AS63/25X5	3/4	25 x 5	260	15	31.8	15.5	55	8	AS63/25X5X		
AS64/25X5	1	25 x 5	260	15	38	20.5	67	10	AS64/25X5X		
AS64/30X4	1	30 x 4	200	22	38	20.5	67	10	AS64/30X4X		
AS65/30X4*	1 1/4	30 x 4	200	22	43.7	17.5	78	10	AS65/30X4X		
AS65/38X5	1 1/4	38 x 5	200	28	43.7	17.5	78	10	AS65/38X5X		
AS65/38X8*	1 1/4	38 x 8	260	22	43.7	17.5	78	10	AS65/38X8X		
AS66/38X5	1 1/2	38 x 5	200	28	50.8	24.5	85	14	AS66/38X5X		
AS66/38X8	1 1/2	38 x 8	260	22	50.8	24.5	85	14	AS66/38X8X		
AS68/50X9	2	50 x 9	260	32	66.6	32.5	116	17	AS68/50X9X		
AS68/65X9	2	65 x 9	190	49	66.6	32.5	116	17	AS68/65X8X		

* Identical types.

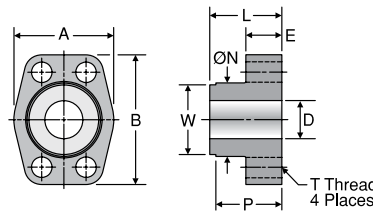
Temperature range without pressure reductions for fittings with O-ring sealing of NBR (e.g., buna N series) -35°C up to +100°C, FPM (e.g., fluorocarbon on request) -25°C up to +120°C.

Tightening torques for socket head cap screws see Tables S6 and S7.

WBT

Code 61 Weld Butt Tank Adapter

Weld Butt with Pilot / Code 61 Block Flange Pad



TUBE FITTING PART #	FLANGE SIZE (in.)	A (in.)	B (in.)	D (in.)	E (in.)	L (in.)	P (in.)	T THREAD UNC-2B	W (in.)	Dynamic Pressure (x 1,000 PSI)	
										-S	-SS
12WBTQ1P	0.75	1.97	2.56	0.75	0.71	1.42	1.30	3/8-16	1.375	0.5	
16WBTQ1P	1.00	2.17	2.75	1.00	0.71	1.50	1.37	3/8-16	1.500	0.5	
20WBTQ1P	1.25	2.68	3.12	1.25	0.83	1.61	1.49	7/16-14	1.750	0.5	
24WBTQ1P	1.50	3.07	3.66	1.50	0.98	1.77	1.64	1/2-13	2.125	0.5	
32WBTQ1P	2.00	3.54	4.00	2.00	0.98	1.77	1.65	1/2-13	2.500	0.5	
40WBTQ1P	2.50	4.09	4.50	2.50	0.98	1.97	1.85	1/2-13	3.250	0.5	

Dimensions and pressures for reference only, subject to change.

WSD

Code 61 Weld Saddle Block Connector
Pipe or Tube Weld Saddle /
Code 61 Block Flange or Pad

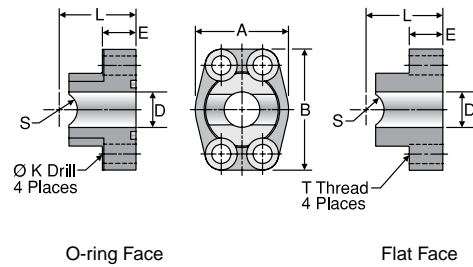


TABLE
OF
CONTENTS

VISUAL
INDEX

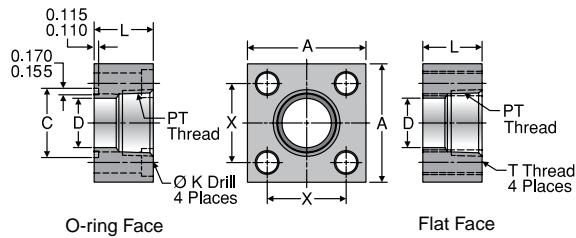
TUBE FITTING PART #		PIPE OR TUBE SIZE (in.)	FLANGE SIZE (in.)	A (in.)	B (in.)	D (in.)	E (in.)	K DRILL DIA. (in.)	L (in.)	S (in.)	T THREAD UNC-2B	MOUNTING HARDWARE SHCS	Dynamic Pressure (x 1,000 PSI)	
O-RING FACE	FLAT FACE												-SX	-SS
PIPE WELD SADDLE / CODE 61 BLOCK FLANGE OR PAD														
12WSD1Q1B	12WSD1Q1P	3/4	0.75	1.97	2.56	0.75	0.710	0.406	1.42	0.532	3/8-16	3/8-16 x 1.50	5.0	
16WSD1Q1B	16WSD1Q1P	1	1.00	2.17	2.75	1.00	0.710	0.406	1.50	0.665	3/8-16	3/8-16 x 1.50	5.0	
20WSD1Q1B	20WSD1Q1P	1 1/4	1.25	2.68	3.12	1.25	0.830	0.469	1.61	0.837	7/16-14	7/16-14 x 1.75	4.0	
24WSD1Q1B	24WSD1Q1P	1 1/2	1.50	3.07	3.66	1.50	0.980	0.531	1.77	0.957	1/2-13	1/2-13 x 1.75	3.0	
32WSD1Q1B	32WSD1Q1P	2	2.00	3.54	4.00	2.00	0.980	0.531	1.77	1.200	1/2-13	1/2-13 x 1.75	3.0	
TUBE WELD SADDLE / CODE 61 BLOCK FLANGE OR PAD														
12WSD2Q1B	12WSD2Q1P	3/4	0.75	1.97	2.56	0.75	0.710	0.406	1.42	0.382	3/8-16	3/8-16 x 1.50	5.0	
16-12WSD2Q1B	16-12WSD2Q1P	1	0.75	1.97	2.56	0.75	0.710	0.406	1.42	0.507	3/8-16	3/8-16 x 1.50	5.0	
16WSD2Q1B	16WSD2Q1P	1	1.00	2.17	2.75	1.00	0.710	0.406	1.50	0.507	3/8-16	3/8-16 x 1.50	5.0	
20-16WSD2Q1B	20-16WSD2Q1P	1 1/4	1.00	2.17	2.75	1.00	0.710	0.406	1.50	0.632	3/8-16	3/8-16 x 1.50	5.0	
20WSD2Q1B	20WSD2Q1P	1 1/4	1.25	2.68	3.12	1.25	0.830	0.469	1.61	0.632	7/16-14	7/16-14 x 1.75	4.0	
24-20WSD2Q1B	24-20WSD2Q1P	1 1/2	1.25	2.68	3.12	1.25	0.830	0.469	1.61	0.757	7/16-14	7/16-14 x 1.75	4.0	
24WSD2Q1B	24WSD2Q1P	1 1/2	1.50	3.07	3.66	1.50	0.980	0.531	1.77	0.757	1/2-13	1/2-13 x 1.75	3.0	
28-24WSD2Q1B	28-24WSD2Q1P	1 3/4	1.50	3.07	3.66	1.50	0.980	0.531	1.77	0.882	1/2-13	1/2-13 x 1.75	3.0	
32WSD2Q1B	32WSD2Q1P	2	2.00	3.54	4.00	2.00	0.980	0.531	1.77	1.007	1/2-13	1/2-13 x 1.75	3.0	
36-32WSD2Q1B	36-32WSD2Q1P	2 1/4	2.00	3.54	4.00	2.00	0.980	0.531	1.77	1.132	1/2-13	1/2-13 x 1.75	3.0	

To receive mounting hardware with flange, insert a "K" after the material designator. Mounting hardware kits are available for O-ring Face part numbers and include 4 bolts, 4 lock washers and an O-ring.

L

GQS

NPTF Port Square Block Flange Adapter
NPTF Port / Square Block Flange or Pad



TUBE FITTING PART #		PT THREAD NPTF	FLANGE SIZE (in.)	A (in.)	B (in.)	C MIN. (in.)	D (in.)	K DRILL DIA. (in.)	L (in.)	T THREAD UNC-2B	X (in.)	O-RING	MOUNTING HARDWARE SHCS	Dynamic Pressure (x 1,000 PSI)	
O-RING FACE	FLAT FACE													-SX	-SS
12GQSB	12GQSP	3/4-14	0.75	2.25	1.12	1.250	0.75	0.406	1.25	3/8-16	1.438	2-214	3/8-16 x 2.00	5.0	
16GQSB	16GQSP	1-11 1/2	1.00	3.00	1.50	1.560	1.00	0.531	1.50	1/2-13	2.000	2-219	1/2-13 x 2.25	5.0	
20GQSB	20GQSP	1 1/4-11 1/2	1.25	3.00	1.50	1.750	1.25	0.531	1.50	1/2-13	2.000	2-222	1/2-13 x 2.25	4.0	
24GQSB	24GQSP	1 1/2-11 1/2	1.50	4.00	2.00	2.115	1.50	0.656	1.75	5/8-11	2.750	2-225	5/8-11 x 2.75	3.0	
32GQSB	32GQSP	2-11 1/2	2.00	4.00	2.00	2.490	2.00	0.656	1.75	5/8-11	2.750	2-228	5/8-11 x 2.75	2.7	
40GQSB	40GQSP	2 1/2-8	2.50	5.50	2.75	2.995	2.50	0.906	2.25	7/8-9	3.750	2-232	7/8-9 x 3.50	2.5	
48GQSB	48GQSP	3-8	3.00	5.50	2.75	3.615	3.00	0.906	2.25	7/8-9	3.750	2-237	7/8-9 x 3.50	1.2	

To receive mounting hardware with flange, insert a "K" after the material designator. Mounting hardware kits are available for O-ring Face part numbers and include 4 bolts, 4 lock washers and an O-ring.

Dimensions and pressures for reference only, subject to change.



W5SQS

Weld Socket Square Block Connector, Pipe
Pipe Weld Socket / Square Block Flange or Pad

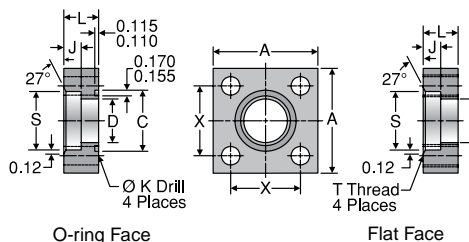


TABLE
OF
CONTENTS

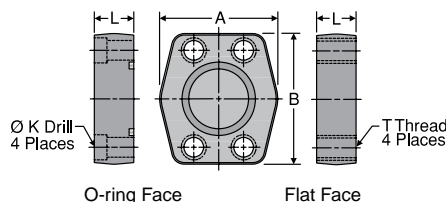
VISUAL
INDEX

TUBE FITTING PART #		PIPE SIZE	FLANGE SIZE	A	B	C MIN.	D	J	K DRILL DIA.	L	S	T THREAD	X	MOUNTING HARDWARE	Dynamic Pressure (x 1,000 PSI)		
O-RING FACE	FLAT FACE	(in.)	(in.)	(in.)	(in.)	(in.)	(in.)	(in.)	(in.)	(in.)	(in.)	UNC-2B	(in.)	O-RING SHCS	-SX	-SS	
12W5SQSB	12W5SQSP	3/4	0.75	2.25	1.12	1.250	0.75	0.50	0.406	1.00	1.062	3/8-16	1.438	2-214	3/8-16 x 1.75	5.0	
16W5SQSB	16W5SQSP	1	1.00	3.00	1.50	1.560	1.00	0.50	0.531	1.00	1.328	1/2-13	2.000	2-219	1/2-13 x 1.75	5.0	
20W5SQSB	20W5SQSP	1 1/4	1.25	3.00	1.50	1.750	1.25	0.50	0.531	1.00	1.672	1/2-13	2.000	2-222	1/2-13 x 1.75	4.0	
24W5SQSB	24W5SQSP	1 1/2	1.50	4.00	2.00	2.115	1.50	0.62	0.656	1.25	1.922	5/8-11	2.750	2-225	5/8-11 x 2.25	3.0	
32W5SQSB	32W5SQSP	2	2.00	4.00	2.00	2.490	2.00	0.62	0.656	1.25	2.406	5/8-11	2.750	2-228	5/8-11 x 2.25	3.0	
40W5SQSB	40W5SQSP	2 1/2	2.50	5.50	2.75	2.995	2.50	0.75	0.906	1.50	2.906	7/8-9	3.750	2-232	7/8-9 x 2.75	2.5	
48W5SQSB	48W5SQSP	3	3.00	5.50	2.75	3.615	3.00	0.75	0.906	1.50	3.547	7/8-9	3.750	2-237	7/8-9 x 2.75	2.0	

To receive mounting hardware with flange, insert a "K" after the material designator. Mounting hardware kits are available for O-ring Face part numbers and include 4 bolts, 4 lock washers and an O-ring.

PQ

Block Plug
Code 61/62 Block Flange or Pad Plug



TUBE FITTING PART #		FLANGE SIZE	A	B	K DRILL DIA.	L	T THREAD	MOUNTING HARDWARE	Dynamic Pressure (x 1,000 PSI)	
O-RING FACE	FLAT FACE	(in.)	(in.)	(in.)	(in.)	(in.)	UNC-2B	SHCS	-SX	-SS ¹
CODE 61 BLOCK FLANGE OR PAD PLUG										
8PQ1B	8PQ1P	0.50	1.813	2.125	0.344	0.750	5/16-18	5/16-18 x 1.50	5.0	
12PQ1B	12PQ1P	0.75	2.063	2.563	0.406	0.750	3/8-16	3/8-16 x 1.50	5.0	
16PQ1B	16PQ1P	1.00	2.313	2.750	0.406	0.880	3/8-16	3/8-16 x 1.75	5.0	
20PQ1B	20PQ1P	1.25	2.875	3.125	0.469	0.940	7/16-14	7/16-14 x 1.75	4.0	
24PQ1B	24PQ1P	1.50	3.250	3.688	0.531	1.190	1/2-13	1/2-13 x 2.25	3.0	
32PQ1B	32PQ1P	2.00	3.813	4.000	0.531	1.440	1/2-13	1/2-13 x 2.50	3.0	
40PQ1B	40PQ1P	2.50	4.281	4.500	0.531	1.815	1/2-13	1/2-13 x 2.75	2.5	
48PQ1B	48PQ1P	3.00	5.156	5.313	0.656	2.190	5/8-11	5/8-11 x 3.50	2.0	
56PQ1B	56PQ1P	3.50	5.500	6.000	0.656	1.440	5/8-11	5/8-11 x 2.75	0.5	
64PQ1B	64PQ1P	4.00	6.000	6.380	0.656	1.440	5/8-11	5/8-11 x 2.75	0.5	
CODE 62 BLOCK FLANGE OR PAD PLUG										
8PQ2B	8PQ2P	0.50	1.940	2.300	0.344	1.250	5/16-18	5/16-18 x 2.00	6.0	
12PQ2B	12PQ2P	0.75	2.500	2.950	0.406	1.250	3/8-16	3/8-16 x 2.00	6.0	
16PQ2B	16PQ2P	1.00	2.750	3.190	0.469	1.500	7/16-14	7/16-14 x 2.50	6.0	
20PQ2B	20PQ2P	1.25	3.060	3.750	0.531	1.430	1/2-13	1/2-13 x 2.50	6.0	
24PQ2B	24PQ2P	1.50	3.750	4.440	0.656	1.815	5/8-11	5/8-11 x 3.00	6.0	
32PQ2B	32PQ2P	2.00	4.500	5.250	0.781	1.815	3/4-10	3/4-10 x 3.00	6.0	
40PQ2B ²	40PQ2P ²	2.50	5.870	6.870	0.940	1.930	7/8-9	7/8-9 x 3.50	6.0	
48PQ2B ²	48PQ2P ²	3.00	7.000	8.500	1.190	2.690	1 1/8-7	1 1/8-7 x 4.50	6.0	

1) See page L40 for standard stainless steel sizes and dimensions.

2) SAE J518 does not cover these sizes in Code 62. Bolt hole centerline dimensions are: 2.312" x 4.875" for 40PQ2 and 2.812" x 6.000" for 48PQ2.

To receive mounting hardware with flange, insert a "K" after the material designator. Mounting hardware kits are available for O-ring Face part numbers and include 4 bolts, 4 lock washers and an O-ring.

Dimensions and pressures for reference only, subject to change.



SPGG5

Flange Spacer with Gage Ports
Code 61/62 Spacer with Side Gage Ports

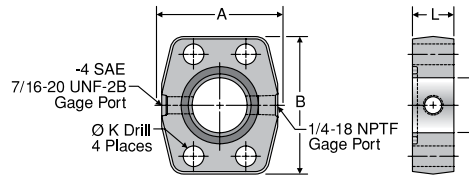


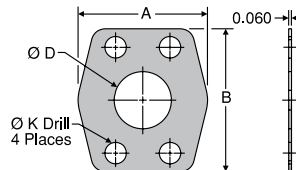
TABLE
OF
CONTENTS

VISUAL
INDEX

TUBE FITTING PART #	FLANGE SIZE (in.)	A (in.)	B (in.)	D (in.)	K DRILL DIA. (in.)	L (in.)	Dynamic Pressure (x 1,000 PSI)	
							-SX	-SS
CODE 61 O-RING SPACER								
8SPGG5Q1B	0.50	1.813	2.125	0.500	0.344	1.25	5.0	
12SPGG5Q1B	0.75	2.063	2.563	0.750	0.406	1.25	5.0	
16SPGG5Q1B	1.00	2.313	2.750	1.000	0.406	0.88	5.0	
20SPGG5Q1B	1.25	2.875	3.125	1.250	0.469	0.94	4.0	
24SPGG5Q1B	1.50	3.250	3.688	1.500	0.531	1.19	3.0	
32SPGG5Q1B	2.00	3.813	4.000	2.000	0.531	1.38	3.0	
40SPGG5Q1B	2.50	4.281	4.500	2.500	0.531	1.75	2.5	
48SPGG5Q1B	3.00	5.156	5.313	3.000	0.656	2.12	2.0	
CODE 62 O-RING SPACER								
8SPGG5Q2B	0.50	1.940	2.300	0.500	0.344	1.25	6.0	
12SPGG5Q2B	0.75	2.500	2.950	0.750	0.406	1.25	6.0	
16SPGG5Q2B	1.00	2.750	3.190	1.000	0.469	1.50	6.0	
20SPGG5Q2B	1.25	3.060	3.750	1.250	0.531	1.50	6.0	
24SPGG5Q2B	1.50	3.750	4.440	1.500	0.656	1.75	6.0	
32SPGG5Q2B	2.00	4.500	5.250	2.000	0.781	1.75	6.0	

CP

Flange Connector Plate
Code 61/62 Flange Connector Plate



L

TUBE FITTING PART #	FLANGE SIZE (in.)	A (in.)	B (in.)	D (in.)	K DRILL DIA. (in.)	Dynamic Pressure (x 1,000 PSI)	
						-SX	-SS
CODE 61 FLANGE CONNECTOR PLATE							
8CP1	0.50	1.81	2.12	0.50	0.344	5.0	
12CP1	0.75	2.06	2.56	0.75	0.406	5.0	
16CP1	1.00	2.31	2.75	1.00	0.406	5.0	
20CP1	1.25	2.88	3.12	1.25	0.469	4.0	
24CP1	1.50	3.25	3.69	1.50	0.531	3.0	
32CP1	2.00	3.81	4.00	2.00	0.531	3.0	
40CP1	2.50	4.12	4.44	2.50	0.531	2.5	
48CP1	3.00	5.16	5.31	3.00	0.656	2.5	
CODE 62 FLANGE CONNECTOR PLATE							
12CP2	0.75	2.38	2.81	0.75	0.406	6.0	
16CP2	1.00	2.75	3.19	1.00	0.469	6.0	
20CP2	1.25	3.06	3.75	1.25	0.531	6.0	
24CP2	1.50	3.75	4.44	1.50	0.656	6.0	
32CP2	2.00	4.50	5.25	2.00	0.781	6.0	

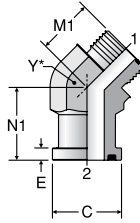
Dimensions and pressures for reference only, subject to change.

TABLE
OF
CONTENTS

VISUAL
INDEX

LOVQ1

Code 61 Flange 45° Elbow
Code 61 / ORFS

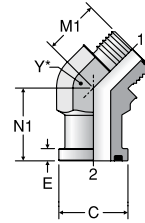


*Y – Across Wrench Flats

TUBE FITTING PART #	END SIZE		C (in.)	E (in.)	M1 (in.)	N1 (in.)	Y (in.)	Dynamic Pressure (x 1,000 PSI) -S
	1 (in.)	2 (in.)						
12 LOVQ1	3/4	3/4	1.500	0.265	1.20	1.58	1 7/16	5.0
16 LOVQ1	1	1	1.750	0.315	1.26	1.85	1 5/8	5.0
20 LOVQ1	1 1/4	1 1/4	2.000	0.315	1.29	2.40	1 7/8	4.0
24 LOVQ1	1 1/2	1 1/2	2.375	0.315	1.45	2.90	2 1/2	3.0

LOVQ2

Code 62 Flange 45° Elbow
Code 62 / ORFS

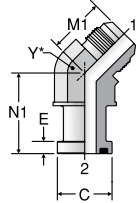


*Y – Across Wrench Flats

TUBE FITTING PART #	END SIZE		C (in.)	E (in.)	M1 (in.)	N1 (in.)	Y (in.)	Dynamic Pressure (x 1,000 PSI) -S
	1 (in.)	2 (in.)						
12 LOVQ2	3/4	3/4	1.625	0.345	1.20	1.83	1 7/16	6.0
16 LOVQ2	1	1	1.875	0.375	1.25	2.07	1 5/8	6.0
20 LOVQ2	1 1/4	1 1/4	2.125	0.405	1.29	2.40	1 7/8	5.0
24 LOVQ2	1 1/2	1 1/2	2.500	0.495	1.45	2.90	2 1/2	4.5

XVQ1

Code 61 Flange 45° Elbow
Code 61 / 37° Flare

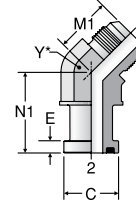


*Y – Across Wrench Flats

TUBE FITTING PART #	END SIZE		C (in.)	E (in.)	M1 (in.)	N1 (in.)	Y (in.)	Dynamic Pressure (x 1,000 PSI) -S
	1 (in.)	2 (in.)						
12 XVQ1	3/4	3/4	1.500	0.265	1.27	1.58	1 7/16	5.0
16 XVQ1	1	1	1.750	0.315	1.47	1.85	1 5/8	5.0
20 XVQ1	1 1/4	1 1/4	2.000	0.315	1.59	2.40	1 7/8	4.0
24 XVQ1	1 1/2	1 1/2	2.375	0.315	1.78	2.90	2 1/2	3.0
32 XVQ1	2	2	2.812	0.375	2.22	3.00	2 1/2	2.0

XVQ2

Code 62 Flange 45° Elbow
Code 62 / 37° Flare

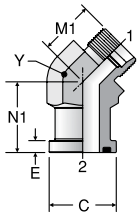


*Y – Across Wrench Flats

TUBE FITTING PART #	END SIZE		C (in.)	E (in.)	M1 (in.)	N1 (in.)	Y (in.)	Dynamic Pressure (x 1,000 PSI) -S
	1 (in.)	2 (in.)						
12 XVQ2	3/4	3/4	1.625	0.345	1.27	1.83	1 7/16	5.0
16 XVQ2	1	1	1.875	0.375	1.47	2.07	1 5/8	5.0
20 XVQ2	1 1/4	1 1/4	2.125	0.405	1.59	2.40	1 7/8	4.0
24 XVQ2	1 1/2	1 1/2	2.500	0.495	1.78	2.90	2 1/2	3.0

BUVQ1

Code 61 45° Elbow
Code 61 / Flareless



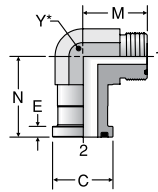
*Y – Across Wrench Flats

TUBE FITTING PART #	END SIZE		C (in.)	E (in.)	M1 (in.)	N1 (in.)	Y (in.)	Dynamic Pressure (x 1,000 PSI) -S
	1 (in.)	2 (in.)						
12 BUVQ1	3/4	3/4	1.500	0.265	1.27	1.58	1 7/16	
16 BUVQ1	1	1	1.750	0.315	1.36	1.85	1 5/8	
20 BUVQ1	1 1/4	1 1/4	2.000	0.315	1.45	2.40	1 7/8	
24 BUVQ1	1 1/2	1 1/2	2.375	0.315	1.52	2.90	2 1/2	
32 BUVQ1	2	2	2.812	0.375	1.83	3.00	2 1/2	

Dimensions and pressures for reference only, subject to change.

LOEQ1

Code 61 Flange 90° Elbow
Code 61 / ORFS

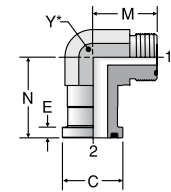


*Y – Across Wrench Flats

TUBE FITTING PART #	END SIZE		C (in.)	E (in.)	M (in.)	N (in.)	Y (in.)	Dynamic Pressure (x 1,000 PSI)		
	1 (in.)	2 (in.)						-S	-SS	-B
12 LOEQ1	3/4	3/4	1.500	0.265	1.95	1.81	1 3/16	5.0		
16 LOEQ1	1	1	1.750	0.315	2.05	2.13	1 7/16	5.0		
20 LOEQ1	1 1/4	1 1/4	2.000	0.315	2.22	2.26	1 5/8	4.0		
24 LOEQ1	1 1/2	1 1/2	2.375	0.315	2.54	2.64	2	3.0		

LOEQ2

Code 62 Flange 90° Elbow
Code 62 / ORFS



*Y – Across Wrench Flats

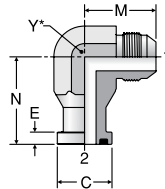
TUBE FITTING PART #	END SIZE		C (in.)	E (in.)	M (in.)	N (in.)	Y (in.)	Dynamic Pressure (x 1,000 PSI)		
	1 (in.)	2 (in.)						-S	-SS	-B
12 LOEQ2	3/4	3/4	1.625	0.345	2.01	2.01	1 3/16	6.0		
16 LOEQ2	1	1	1.875	0.375	2.17	2.42	1 7/16	6.0		
20 LOEQ2	1 1/4	1 1/4	2.125	0.405	2.50	2.68	1 5/8	5.0		
24 LOEQ2	1 1/2	1 1/2	2.500	0.495	2.87	3.13	2	4.5		

TABLE OF CONTENTS

VISUAL INDEX

XEQ1

Code 61 Flange 90° Elbow
Code 61 / 37° Flare

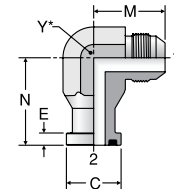


*Y – Across Wrench Flats

TUBE FITTING PART #	END SIZE		C (in.)	E (in.)	M (in.)	N (in.)	Y (in.)	Dynamic Pressure (x 1,000 PSI)		
	1 (in.)	2 (in.)						-S	-SS	-B
12 XEQ1	3/4	3/4	1.500	0.265	1.91	1.81	1 3/16	5.0		
16 XEQ1	1	1	1.750	0.315	2.07	2.13	1 7/16	5.0		
20 XEQ1	1 1/4	1 1/4	2.000	0.315	2.26	2.26	1 5/8	4.0		
24 XEQ1	1 1/2	1 1/2	2.375	0.315	2.72	2.64	2	3.0		
32 XEQ1	2	2	2.812	0.375	3.06	4.25	2 1/2	2.0		

XEQ2

Code 62 Flange 90° Elbow
Code 62 / 37° Flare

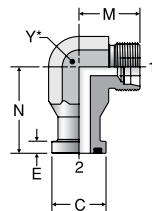


*Y – Across Wrench Flats

TUBE FITTING PART #	END SIZE		C (in.)	E (in.)	M (in.)	N (in.)	Y (in.)	Dynamic Pressure (x 1,000 PSI)		
	1 (in.)	2 (in.)						-S	-SS	-B
12 XEQ2	3/4	3/4	1.625	0.345	1.97	2.04	1 3/16	5.0		
16 XEQ2	1	1	1.875	0.375	2.19	2.42	1 7/16	5.0		
20 XEQ2	1 1/4	1 1/4	2.125	0.405	2.56	2.68	1 5/8	4.0		
24 XEQ2	1 1/2	1 1/2	2.500	0.495	3.03	3.13	2	3.0		

BUEQ1

Code 61 90° Elbow
Code 61 / Flareless



*Y – Across Wrench Flats

TUBE FITTING PART #	END SIZE		C (in.)	E (in.)	M (in.)	N (in.)	Y (in.)	Dynamic Pressure (x 1,000 PSI)		
	1 (in.)	2 (in.)						-S	-SS	-B
12 BUEQ1	3/4	3/4	1.500	0.265	1.73	1.81	1 3/16			
16 BUEQ1	1	1	1.750	0.315	1.99	2.13	1 7/16			
20 BUEQ1	1 1/4	1 1/4	2.000	0.315	1.99	2.26	1 5/8			
24 BUEQ1	1 1/2	1 1/2	2.375	0.315	2.33	2.64	2			
32 BUEQ1	2	2	2.812	0.375	2.45	4.25	2 1/2			

Dimensions and pressures for reference only, subject to change.

W7EQ

Weld Socket Block Elbow Connector, Pipe
Weld Socket, Pipe / Code 61 or 62
Block Flange or Pad

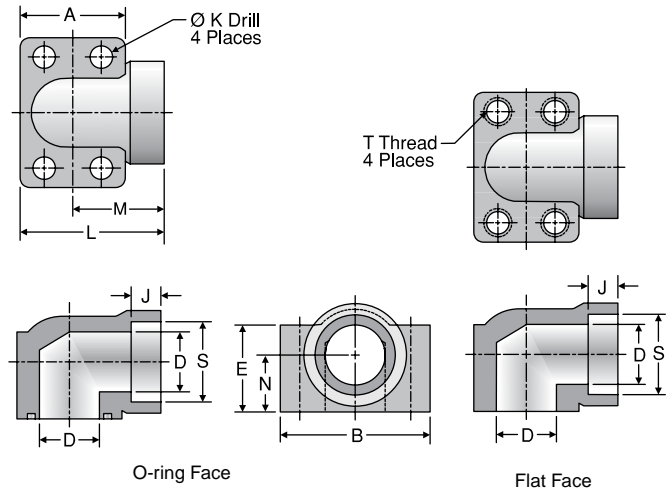


TABLE OF CONTENTS

VISUAL INDEX

TUBE FITTING PART #		PIPE SIZE (in.)	FLANGE SIZE (in.)	A (in.)	B (in.)	D (in.)	E (in.)	J (in.)	K DRILL DIA. (in.)	L (in.)	M (in.)	N (in.)	S (in.)	T THREAD UNC-2B	MOUNTING HARDWARE SHCS	Dynamic Pressure (x 1,000 PSI)	
O-RING FACE	FLAT FACE															-SX	-SS
WELD SOCKET, PIPE / CODE 61 BLOCK FLANGE OR PAD																	
12W7EQ1B	12W7EQ1P	3/4	0.75	1.69	2.56	0.75	1.25	0.56	0.406	2.28	1.44	0.875	1.062	3/8-16	3/8-16 x 2.00	5.0	
16W7EQ1B	16W7EQ1P	1	1.00	1.94	2.75	1.00	1.50	0.56	0.406	2.62	1.66	1.062	1.328	3/8-16	3/8-16 x 2.25	4.5	
20W7EQ1B	20W7EQ1P	1 1/4	1.25	2.19	3.12	1.25	1.81	0.62	0.469	3.00	1.91	1.188	1.672	7/16-14	7/16-14 x 2.75	3.5	
24W7EQ1B	24W7EQ1P	1 1/2	1.50	2.56	3.69	1.50	2.00	0.69	0.531	3.33	2.05	1.312	1.922	1/2-13	1/2-13 x 3.00	3.0	
32W7EQ1B	32W7EQ1P	2	2.00	3.06	4.33	2.00	2.50	0.75	0.531	3.81	2.28	1.656	2.406	1/2-13	1/2-13 x 3.50	3.0	
WELD SOCKET, PIPE / CODE 62 BLOCK FLANGE OR PAD																	
12W7EQ2B	12W7EQ2P	3/4	0.75	1.94	2.75	0.75	1.50	0.56	0.406	2.62	1.66	1.062	1.062	3/8-16	3/8-16 x 2.25	6.0	
16W7EQ2B	16W7EQ2P	1	1.00	2.19	3.12	1.00	1.81	0.62	0.469	3.00	1.91	1.188	1.328	7/16-14	7/16-14 x 2.50	6.0	
20W7EQ2B	20W7EQ2P	1 1/4	1.25	2.56	3.69	1.25	2.00	0.69	0.531	3.32	2.05	1.312	1.672	1/2-13	1/2-13 x 3.00	5.0	
24W7EQ2B	24W7EQ2P	1 1/2	1.50	3.06	4.33	1.50	2.50	0.75	0.656	3.81	2.28	1.656	1.922	5/8-11	5/8-11 x 3.50	5.0	

To receive mounting hardware with flange, insert a "K" after the material designator. Mounting hardware kits are available for O-ring Face part numbers and include 4 bolts, 4 lock washers and an O-ring.

Dimensions and pressures for reference only, subject to change.



WFS

SAE Flange Connection
Code 61 & 62 / Metric Flareless

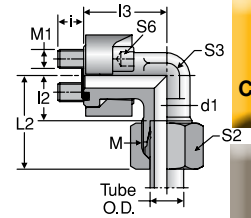


TABLE OF CONTENTS

VISUAL INDEX

TUBE FITTING PART #	SIZE (in.)	END SIZE (mm)	WORKING PRESSURE (bar)	M THREAD	d1 (mm)	I (mm)	I1 (mm)	I2 (mm)	I3 (mm)	L1 ≈ (mm)	L2 ≈ (mm)	S1 (mm)	S2 (mm)	S3 (mm)	S6 (mm)	FROM STOCK		FROM STOCK	
																CF	71	CF	71
SAE FLANGE CONNECTIONS – CODE 61 – STANDARD SERIES																			
WFS32/15LCF	1/2	15L	200	M22 x 1.5	12	11.5	41	29	36	56	44	24	27	24	6	•		•	
WFS32/16SCF	1/2	16S	220	M24 x 1.5	12	11.5	41.5	29.5	36	60	48	24	30	24	6	•		•	
WFS33/18LCF	3/4	18L	200	M26 x 1.5	15	15.5	45.5	31.5	42	62	48	30	32	30	8	•		•	
WFS33/22LCF	3/4	22L	100	M30 x 2	19	15.5	45.5	33.5	42	62	50	30	36	30	8	•		•	
WFS33/20SCF	3/4	20S	220	M30 x 2	16	15.5	46.5	32.5	42	68	54	30	36	30	8	•		•	
WFS33/25SCF	3/4	25S	220	M36 x 2	17	15.5	45	33	42	69	57	30	46	30	8	•		•	
WFS34/28LCF	1	28L	100	M36 x 2	24	13.5	46.5	36.5	45	63	53	36	41	36	8	•		•	
WFS34/30SCF	1	30S	220	M42 x 2	24	13.5	49.5	36.5	45	76	63	36	50	36	8	•		•	
WFS35/35LCF	1 1/4	35L	100	M45 x 2	30	18.5	47.5	46.5	50	69	68	41	50	41	8	•		•	
WFS35/25SCF	1 1/4	25S	175	M36 x 2	20	18.5	48	43	50	72	67	41	46	41	8	•		•	
WFS35/30SCF	1 1/4	30S	175	M42 x 2	25	18.5	48.5	43.5	50	75	70	41	50	41	8	•		•	
WFS35/38SCF	1 1/4	38S	175	M52 x 2	28	18.5	50	43	50	81	74	46	60	41	8	•		•	
WFS36/42LCF	1 1/2	42L	100	M52 x 2	36	18.5	53	47	55	76	70	46	60	50	10	•		•	
WFS36/38SCF	1 1/2	38S	130	M52 x 2	32	18.5	54	48	55	85	79	46	60	50	10	•		•	
SAE FLANGE CONNECTIONS – CODE 62 – HIGH PRESSURE SERIES																			
WFS62/16SCF	1/2	16S	250	M24 x 1.5	12	13.5	44.5	29.5	39	63	48	24	30	24	6	•		•	
WFS63/16SCF	3/4	16S	250	M24 x 1.5	12	15.5	50.5	36.5	48	69	55	30	30	32	8	•		•	
WFS63/20SCF	3/4	20S	250	M30 x 2	16	15.5	50.5	35.5	48	72	57	30	36	32	8	•		•	
WFS63/25SCF	3/4	25S	250	M36 x 2	17	15.5	51	36	48	75	60	30	46	32	8	•		•	
WFS64/25SCF	1	25S	250	M36 x 2	20	20.5	60	44	60	84	65	36	46	41	10	•		•	
WFS64/30SCF	1	30S	250	M42 x 2	24	20.5	60.5	41.5	60	87	68	36	50	41	10	•		•	
WFS65/30SCF	1 1/4	30S	250	M42 x 2	25	22.5	65.5	44.5	68	92	71	41	50	46	10	•		•	
WFS65/38SCF	1 1/4	38S	200	M52 x 2	30	22.5	67	45	68	98	76	46	60	46	10	•		•	
WFS66/38SCF	1 1/2	38S	200	M52 x 2	30	24.5	73	56	76	104	87	46	60	50	14	•		•	

EO-2 Part Number example: WFS33/18ZLCF

Temperature range without pressure reductions for fittings with O-ring sealing of NBR (e.g., buna N series) -35°C up to +100°C, FPM (e.g., fluorocarbon on request) -25°C up to +120°C.

Tightening torques for socket head cap screws see Tables S6 and S7.

Dimensions and pressures for reference only, subject to change.



BFW

Hydraulic Flange Elbow
DIN Flange / Metric Flareless

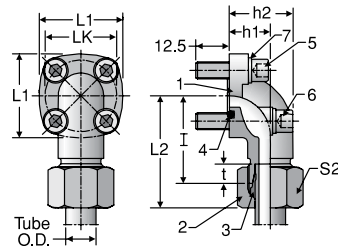


TABLE
OF
CONTENTS

VISUAL
INDEX

TUBE FITTING PART #	WORKING PRESSURE (bar)	END SIZE (mm)	h1 (mm)	h1 (mm)	l (mm)	L1 (mm)	L2 (mm)	LK (mm)	S2 (mm)	t (mm)	MATERIAL FROM STOCK		EO-2 FROM STOCK	
											CF	71	CF	71
BFW15L/LK40CF	65	15	22.5	36.5	38	42	46	40	27	7	•		•	
BFW18L/LK40CF	65	18	22.5	36.5	38	42	47	40	32	7.5	•		•	
BFW22L/LK40CF	65	22	22.5	36.5	38	42	47.5	40	36	7.5	•		•	
BFW28L/LK40CF	65	28	28	43	40	42	49	40	41	7.5	•		•	
BFW35L/LK40CF	65	35	32	55	41	42	52	40	50	10.5	•		•	
BFW35L/LK55CF	65	35	32	51.5	49	58	62	55	50	10.5	•		•	
BFW42L/LK55CF	65	42	40	64.5	49	58	61	55	60	11	•		•	
BFW15L/LK35CF	155	15	16.5	26.5	38	39	46	35	27	7	•		•	
BFW20S/LK55CF	155	20	24	38	45	58	56	55	36	10.5	•		•	
BFW20S/LK40CF	155	20	22.5	35.5	40	42	50	40	36	10.5	•		•	
BFW25S/LK55CF	155	25	30	46	49	58	61	55	46	12	•		•	
BFW30S/LK55CF	155	30	32	50	49	58	62	55	50	13.5	•		•	
BFW10L/LK35CF	200	10	16.5	26.5	38	39	47	35	19	7	•		•	
BFW12L/LK35CF	200	12	16.5	26.5	38	39	47	35	22	7	•		•	
BFW16S/LK35CF	200	16	20	31	38	39	48	35	30	8.5	•		•	

Unassembled BFW Fitting Components

1 Elbow Body	2 Nut	3 Progressive Ring	4 O-Ring	5 2 Cap Screws DIN 912-8.8	6 2 Cap Screws DIN 912-8.8	7 4 Spr. Washers DIN 127
BFW15L/LK40CFX	M15LCFX	DPR15LCFX	OR26X2.5X	M6X22	M6X22	A6
BFW18L/LK40CFX	M18LCFX	DPR18LCFX	OR26X2.5X	M6X22	M6X22	A6
BFW22L/LK40CFX	M22LCFX	DPR22LCFX	OR26X2.5X	M6X22	M6X22	A6
BFW28L/LK40CFX	M28LCFX	DPR28LCFX	OR26X2.5X	M6X20	M6X50	A6
BFW35L/LK40CFX	M35LCFX	DPR35LCFX	OR26X2.5X	M6X22	M6X60	A6
BFW35L/LK55CFX	M35LCFX	DPR35LCFX	OR33X2.5X	M8X25	M8X60	A8
BFW42L/LK55CFX	M42LCFX	DPR42LCFX	OR33X2.5X	M8X25	M8X70	A8
BFW15L/LK35CFX	M15LCFX	DPR15LCFX	OR20X2.5X	M6X22	M6X35	A6
BFW20S/LK55CFX	M20SCFX	DPR20SCFX	OR33X2.5X	M8X25	M8X50	A8
BFW20S/LK40CFX	M20SCFX	DPR20SCFX	OR26X2.5X	M6X22	M6X45	A6
BFW25S/LK55CFX	M25SCFX	DPR25SCFX	OR33X2.5X	M8X25	M8X55	A8
BFW30S/LK55CFX	M30SCFX	DPR20SCFX	OR33X2.5X	M8X25	M8X55	A8
BFW10L/LK35CFX	M10LCFX	DRP10LCFX	OR20X2.5X	M6X22	M6X35	A6
BFW12L/LK35CFX	M12LCFX	DPR12LCFX	OR20X2.5X	M6X22	M6X35	A6
BFW16S/LK35CFX	M16SCFX	DPR16SCFX	OR20X2.5X	M6X22	M6X40	A6
BFW20S/LK35CFX	M20SCFX	DPR20SCFX	OR20X2.5X	M6X22	M6X45	A6

EO-2 Part Number example: BFW15ZL/LK40CF

Temperature range without pressure reductions for fittings with O-ring sealing of NBR (e.g., buna N series) -35°C up to +100°C, FPM (e.g., fluorocarbon on request) -25°C up to +120°C.

Tightening torques for socket head cap screws see Table S6.

Dimensions and pressures for reference only, subject to change.

QPQPJQ

Block Junction Tee
Code 61 or 62 Block Pads / Block Flange or Pad

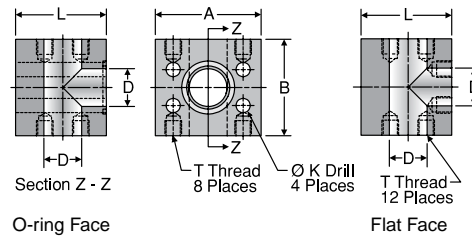


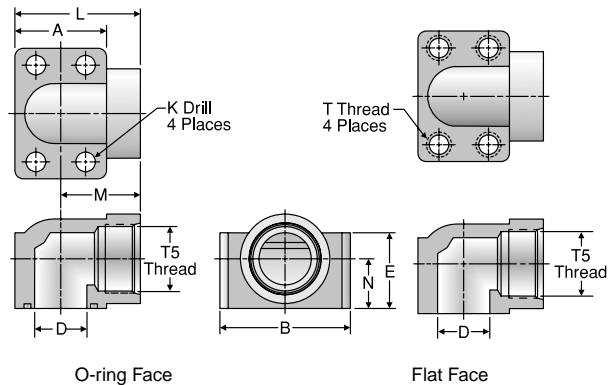
TABLE
OF
CONTENTS

VISUAL
INDEX

TUBE FITTING PART #		FLANGE SIZE (in.)	A (in.)	B (in.)	D (in.)	K DRILL DIA. (in.)	L (in.)	T THREAD UNC-2B	Dynamic Pressure (x 1,000 PSI)	
O-RING FACE	FLAT FACE								-SX	-SS
CODE 61 BLOCK PADS / BLOCK FLANGE OR PAD										
12Q1PQ1PJQ1B	12Q1PQ1PJQ1P	0.75	2.62	2.75	0.75	0.406	2.25	3/8-16	5.0	
16Q1PQ1PJQ1B	16Q1PQ1PJQ1P	1.00	2.82	3.00	1.00	0.406	2.50	3/8-16	5.0	
20Q1PQ1PJQ1B	20Q1PQ1PJQ1P	1.25	3.19	3.50	1.25	0.469	3.00	7/16-14	4.0	
24Q1PQ1PJQ1B	24Q1PQ1PJQ1P	1.50	3.75	4.00	1.50	0.531	3.50	1/2-13	3.0	
32Q1PQ1PJQ1B	32Q1PQ1PJQ1P	2.00	4.00	4.25	2.00	0.531	4.00	1/2-13	3.0	
CODE 62 BLOCK PADS / BLOCK FLANGE OR PAD										
12Q2PQ2PJQ2B	12Q2PQ2PJQ2P	0.75	2.81	3.00	0.75	0.406	2.50	3/8-16	6.0	
16Q2PQ2PJQ2B	16Q2PQ2PJQ2P	1.00	3.19	3.50	1.00	0.469	3.00	7/16-14	6.0	
20Q2PQ2PJQ2B	20Q2PQ2PJQ2P	1.25	3.75	4.00	1.25	0.531	3.50	1/2-13	6.0	
24Q2PQ2PJQ2B	24Q2PQ2PJQ2P	1.50	4.50	4.50	1.50	0.656	4.00	5/8-11	6.0	
32Q2PQ2PJQ2B	32Q2PQ2PJQ2P	2.00	5.25	5.00	1.94	0.781	5.00	3/4-10	6.0	

G5EQ

SAE Port Block Elbow
SAE Port / Code 61 or 62 Block Flange or Pad



L

TUBE FITTING PART #		T5 STRAIGHT THREAD UN-2B	SAE PORT DASH SIZE	FLANGE SIZE (in.)	A (in.)	B (in.)	D (in.)	E (in.)	K DRILL DIA. (in.)	L (in.)	M (in.)	N (in.)	T THREAD UNC-2B	MOUNTING HARDWARE SHCS		Dynamic Pressure (x 1,000 PSI)	
O-RING FACE	FLAT FACE													-SX	-SS		
SAE PORT / CODE 61 BLOCK FLANGE OR PAD																	
12G5EQ1B	12G5EQ1P	1-1/16-12	12	0.75	1.69	2.56	0.75	1.25	0.406	2.28	1.440	0.875	3/8-16	3/8-16 x 2.00	4.0		
16G5EQ1B	16G5EQ1P	1-5/16-12	16	1.00	1.94	2.75	1.00	1.50	0.406	2.62	1.660	1.062	3/8-16	3/8-16 x 2.25	3.0		
20G5EQ1B	20G5EQ1P	1-5/8-12	20	1.25	2.19	3.12	1.25	1.81	0.469	3.00	1.910	1.188	7/16-14	7/16-14 x 2.75	2.5		
24G5EQ1B	24G5EQ1P	1-7/8-12	24	1.50	2.56	3.69	1.50	2.00	0.531	3.33	2.050	1.312	1/2-13	1/2-13 x 3.00	2.0		
32G5EQ1B	32G5EQ1P	2-1/2-12	32	2.00	3.06	4.33	2.00	2.50	0.531	3.81	2.280	1.656	1/2-13	1/2-13 x 3.50	1.5		
SAE PORT / CODE 62 BLOCK FLANGE OR PAD																	
12G5EQ2B	12G5EQ2P	1-1/16-12	12	0.75	1.94	2.75	0.75	1.50	0.406	2.62	1.660	1.062	3/8-16	3/8-16 x 2.25	5.0		
16G5EQ2B	16G5EQ2P	1-5/16-12	16	1.00	2.19	3.12	1.00	1.81	0.469	3.00	1.910	1.188	7/16-14	7/16-14 x 2.50	4.0		
20G5EQ2B	20G5EQ2P	1-5/8-12	20	1.25	2.56	3.69	1.25	2.00	0.531	3.32	2.050	1.312	1/2-13	1/2-13 x 3.00	3.5		
24G5EQ2B	24G5EQ2P	1-7/8-12	24	1.50	3.06	4.33	1.50	2.50	0.656	3.81	2.280	1.656	5/8-11	5/8-11 x 3.50	3.5		

To receive mounting hardware with flange, insert a "K" after the material designator. Mounting hardware kits are available for O-ring Face part numbers and include 4 bolts, 4 lock washers and an O-ring.

Dimensions and pressures for reference only, subject to change.



GEQ

NPTF Port Block Elbow Adapter
 NPTF / Code 61 or 62 Block Flange or Pad

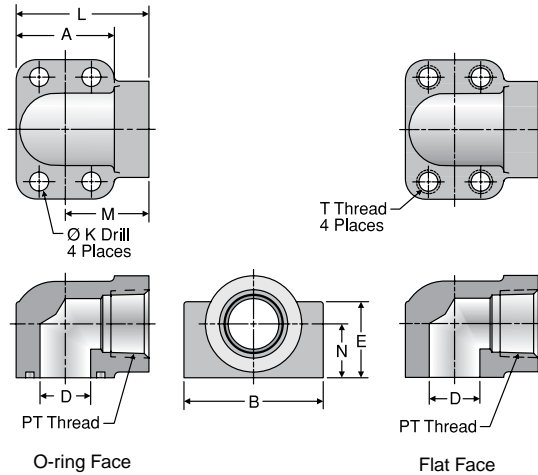


TABLE
 OF
 CONTENTS

VISUAL
 INDEX

TUBE FITTING PART #		PT THREAD NPTF	FLANGE SIZE (in.)	A (in.)	B (in.)	D (in.)	E (in.)	K DRILL DIA. (in.)	L (in.)	M (in.)	N (in.)	T THREAD UNC-2B	MOUNTING HARDWARE SHCS	Dynamic Pressure (x 1,000 PSI)	
O-RING FACE	FLAT FACE													-SX	-SS
NPTF PORT / CODE 61 BLOCK FLANGE OR PAD															
12GEQ1B	12GEQ1P	3/4 - 14	0.75	1.69	2.56	0.75	1.25	0.406	2.28	1.440	0.875	3/8-16	3/8-16 x 2.00	4.0	
16GEQ1B	16GEQ1P	1 - 11 1/2	1.00	1.94	2.75	1.00	1.50	0.406	2.62	1.660	1.062	3/8-16	3/8-16 x 2.25	4.0	
20GEQ1B	20GEQ1P	1 1/4 - 11 1/2	1.25	2.19	3.12	1.25	1.81	0.469	3.00	1.910	1.188	7/16-14	7/16-14 x 2.75	2.7	
24GEQ1B	24GEQ1P	1 1/2 - 11 1/2	1.50	2.56	3.69	1.50	2.00	0.531	3.33	2.050	1.312	1/2-13	1/2-13 x 3.00	2.5	
32GEQ1B	32GEQ1P	2 - 11 1/2	2.00	3.06	4.33	2.00	2.50	0.531	3.81	2.280	1.656	1/2-13	1/2-13 x 3.50	1.7	
NPTF PORT / CODE 62 BLOCK FLANGE OR PAD															
12GEQ2B	12GEQ2P	3/4 - 14	0.75	1.94	2.75	0.75	1.50	0.406	2.62	1.660	1.062	3/8-16	3/8-16 x 2.25	5.5	
16GEQ2B	16GEQ2P	1 - 11 1/2	1.00	2.19	3.12	1.00	1.81	0.469	3.00	1.910	1.188	7/16-14	7/16-14 x 2.50	5.0	
20GEQ2B	20GEQ2P	1 1/4 - 11 1/2	1.25	2.56	3.69	1.25	2.00	0.531	3.32	2.050	1.312	1/2-13	1/2-13 x 3.00	3.5	
24GEQ2B	24GEQ2P	1 1/2 - 11 1/2	1.50	3.06	4.33	1.50	2.50	0.656	3.81	2.280	1.656	5/8-11	5/8-11 x 3.50	3.0	

To receive mounting hardware with flange, insert a "K" after the material designator. Mounting hardware kits are available for O-ring Face part numbers and include 4 bolts, 4 lock washers and an O-ring.

Dimensions and pressures for reference only, subject to change.



W6EQ

Weld Socket Block Elbow Connector, Tube
Weld Socket, Tube / Code 61 or 62 Block Flange or Pad

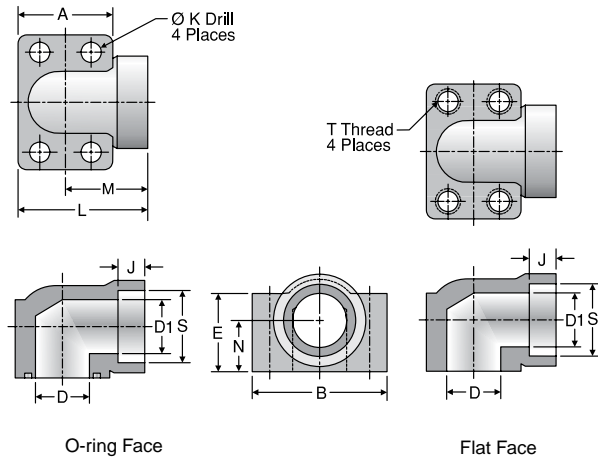


TABLE OF CONTENTS
VISUAL INDEX

TUBE FITTING PART #		TUBE O.D. (in.)	FLANGE SIZE (in.)	A (in.)	B (in.)	D (in.)	D1 (in.)	E (in.)	J (in.)	K DRILL DIA. (in.)	L (in.)	M (in.)	N (in.)	S (in.)	T THREAD UNC-2B	MOUNTING HARDWARE SHCS		Dynamic Pressure (x 1,000 PSI)	
O-RING FACE	FLAT FACE															-SX	-SS	-SX	-SS
WELD SOCKET, TUBE / CODE 61 BLOCK FLANGE OR PAD																			
12W6EQ1B	12W6EQ1P	3/4	0.75	1.69	2.56	0.75	0.63	1.25	0.312	0.406	2.280	1.44	0.875	0.752	3/8-16	3/8-16 x 2.00	5.0		
16-12W6EQ1B	16-12W6EQ1P	1	0.75	1.69	2.56	0.75	0.75	1.25	0.438	0.406	2.280	1.44	0.875	1.002	3/8-16	3/8-16 x 2.00	5.0		
16W6EQ1B	16W6EQ1P	1	1.00	1.94	2.75	1.00	0.88	1.50	0.438	0.406	2.620	1.66	1.062	1.002	3/8-16	3/8-16 x 2.25	5.0		
20-16W6EQ1B	20-16W6EQ1P	1 1/4	1.00	1.94	2.75	1.00	1.00	1.50	0.500	0.406	2.620	1.66	1.062	1.252	3/8-16	3/8-16 x 2.25	5.0		
20W6EQ1B	20W6EQ1P	1 1/4	1.25	2.19	3.12	1.25	1.13	1.81	0.500	0.469	3.000	1.91	1.188	1.252	7/16-14	7/16-14 x 2.75	4.0		
24-20W6EQ1B	24-20W6EQ1P	1 1/2	1.25	2.19	3.12	1.25	1.25	1.81	0.562	0.469	3.000	1.91	1.188	1.502	7/16-14	7/16-14 x 2.75	4.0		
24W6EQ1B	24W6EQ1P	1 1/2	1.50	2.56	3.69	1.50	1.38	2.00	0.562	0.531	3.328	2.05	1.312	1.502	1/2-13	1/2-13 x 3.00	3.0		
28-24W6EQ1B	28-24W6EQ1P	1 3/4	1.50	2.56	3.69	1.50	1.50	2.00	0.562	0.531	3.328	2.05	1.312	1.752	1/2-13	1/2-13 x 3.00	3.0		
32W6EQ1B	32W6EQ1P	2	2.00	3.06	4.33	2.00	1.88	2.50	0.625	0.531	3.812	2.28	1.656	2.002	1/2-13	1/2-13 x 3.50	3.0		
36-32W6EQ1B	36-32W6EQ1P	2 1/4	2.00	3.06	4.33	2.00	2.00	2.50	0.625	0.531	3.812	2.28	1.656	2.252	1/2-13	1/2-13 x 3.50	3.0		
WELD SOCKET, TUBE / CODE 62 BLOCK FLANGE OR PAD																			
12W6EQ2B	12W6EQ2P	3/4	0.75	1.94	2.75	0.75	0.63	1.50	0.560	0.406	2.620	1.66	1.062	0.752	3/8-16	3/8-16 x 2.25	6.0		
16-12W6EQ2B	16-12W6EQ2P	1	0.75	1.94	2.75	0.75	0.75	1.50	0.620	0.406	2.620	1.66	1.062	1.002	3/8-16	3/8-16 x 2.25	6.0		
16W6EQ2B	16W6EQ2P	1	1.00	2.19	3.12	1.00	0.88	1.81	0.620	0.469	3.000	1.91	1.188	1.002	7/16-14	7/16-14 x 2.50	6.0		
20-16W6EQ2B	20-16W6EQ2P	1 1/4	1.00	2.19	3.12	1.00	1.00	1.81	0.690	0.469	3.000	1.91	1.188	1.252	7/16-14	7/16-14 x 2.50	6.0		
20W6EQ2B	20W6EQ2P	1 1/4	1.25	2.56	3.69	1.25	1.13	2.00	0.690	0.531	3.320	2.05	1.312	1.252	1/2-13	1/2-13 x 3.00	6.0		
24-20W6EQ2B	24-20W6EQ2P	1 1/2	1.25	2.56	3.69	1.25	1.25	2.00	0.750	0.531	3.320	2.05	1.312	1.502	1/2-13	1/2-13 x 3.00	6.0		
24W6EQ2B	24W6EQ2P	1 1/2	1.50	3.06	4.33	1.50	1.38	2.50	0.750	0.656	3.810	2.28	1.656	1.502	5/8-11	5/8-11 x 3.50	6.0		
28-24W6EQ2B	28-24W6EQ2P	1 3/4	1.50	3.06	4.33	1.50	1.50	2.50	0.750	0.656	3.810	2.28	1.656	1.752	5/8-11	5/8-11 x 3.50	6.0		

To receive mounting hardware with flange, insert a "K" after the material designator. Mounting hardware kits are available for O-ring Face part numbers and include 4 bolts, 4 lock washers and an O-ring.

Dimensions and pressures for reference only, subject to change.

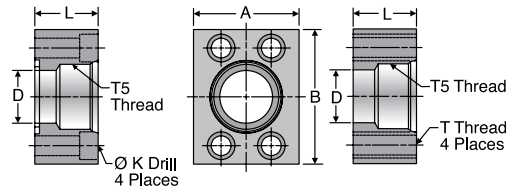


TABLE
OF
CONTENTS

VISUAL
INDEX

G5Q – Stainless Steel

SAE Port Block Flange Adapter
SAE Port / Code 61 or 62 Block Flange



O-ring Face

Flat Face

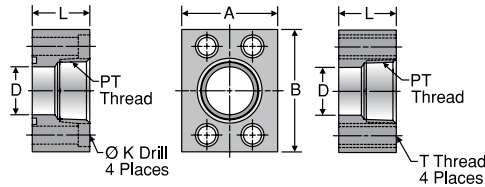
TUBE FITTING PART #		SAE PORT DASH SIZE	FLANGE SIZE (in.)	A (in.)	B (in.)	D (in.)	K DRILL DIA. (in.)	L (in.)	T5 STRAIGHT THREAD UN-2B	MOUNTING HARDWARE SHCS	Dynamic Pressure (x 1,000 PSI) -SS
O-RING FACE	FLAT FACE										
SAE PORT / CODE 61 FLANGE BLOCK											
8G5Q1B	*	8	0.50	1.50	2.12	0.50	0.344	1.20	3/4-16	5/16-18 x 1.25	5.0
12G5Q1B	*	12	0.75	1.75	2.62	0.75	0.406	1.20	1 1/16-12	3/8-16 x 1.50	5.0
16G5Q1B	*	16	1.00	2.00	2.82	1.00	0.406	1.45	1 5/16-12	3/8-16 x 1.50	5.0
20G5Q1B	*	20	1.25	2.50	3.19	1.25	0.469	1.45	1 5/8-12	7/16-14 x 1.75	4.0
24G5Q1B	*	24	1.50	2.75	3.75	1.50	0.531	1.70	1 7/8-12	1/2-13 x 2.00	3.0
32G5Q1B	*	32	2.00	3.25	4.00	2.00	0.531	1.70	2 1/2-12	1/2-13 x 2.00	
SAE PORT / CODE 62 FLANGE BLOCK											
8G5Q2B	*	8	0.50	1.75	2.22	0.50	0.344	0.95	3/4-16	5/16-18 x 1.25	6.0
12G5Q2B	*	12	0.75	2.00	2.81	0.75	0.406	1.20	1 1/16-12	3/8-16 x 1.50	6.0
16G5Q2B	*	16	1.00	2.25	3.19	1.00	0.469	1.45	1 5/16-12	7/16-14 x 1.75	6.0
20G5Q2B	*	20	1.25	2.75	3.75	1.25	0.531	1.45	1 5/8-12	1/2-13 x 1.75	6.0
24G5Q2B	*	24	1.50	3.25	4.50	1.50	0.656	1.70	1 7/8-12	5/8-11 x 2.00	5.0
32G5Q2B	*	32	2.00	4.00	5.25	2.00	0.781	1.70	2 1/2-12	3/4-10 x 2.25	3.0

* Consult factory.

To receive mounting hardware with flange, insert a "K" after the material designator. Mounting hardware kits are available for O-ring Face part numbers and include 4 bolts, 4 lock washers and an O-ring.

GQ – Stainless Steel

NPTF Port Block Flange Adapter
NPTF Port / Code 61 or 62 Block Flange



O-ring Face

Flat Face

TUBE FITTING PART #		PT THREAD NPTF	FLANGE SIZE (in.)	A (in.)	B (in.)	D (in.)	K DRILL DIA. (in.)	L (in.)	MOUNTING HARDWARE SHCS	Dynamic Pressure (x 1,000 PSI) -SS
O-RING FACE	FLAT FACE									
NPTF PORT / CODE 61 BLOCK FLANGE										
8GQ1B	*	1/2-14	0.50	1.50	2.12	0.50	0.344	1.25	5/16-18 x 1.75	5.0
12GQ1B	*	3/4-14	0.75	1.75	2.62	0.75	0.406	1.25	3/8-16 x 2.00	5.0
16GQ1B	*	1-11 1/2	1.00	2.00	2.82	1.00	0.406	1.50	3/8-16 x 2.25	5.0
20GQ1B	*	1 1/4-11 1/2	1.25	2.50	3.19	1.25	0.469	1.50	7/16-14 x 2.25	4.0
24GQ1B	*	1 1/2-11 1/2	1.50	2.75	3.75	1.50	0.531	1.75	1/2-13 x 2.50	3.0
32GQ1B	*	2-11 1/2	2.00	3.25	4.00	2.00	0.531	1.75	1/2-13 x 2.50	2.7
40GQ1B	*	2 1/2-8	2.50	4.00	4.50	2.50	0.531	2.00	1/2-13 x 2.75	2.5
48GQ1B	*	3-8	3.00	4.50	5.31	3.00	0.656	2.25	5/8-11 x 3.00	1.2
NPTF PORT / CODE 62 BLOCK FLANGE										
12GQ2B	*	3/4-14	0.75	2.00	2.81	0.75	0.406	1.20	3/8-16 x 2.00	6.0
16GQ2B	*	1-11 1/2	1.00	2.25	3.19	1.00	0.469	1.45	7/16-14 x 2.50	5.0
20GQ2B	*	1 1/4-11 1/2	1.25	2.75	3.75	1.25	0.531	1.45	1/2-13 x 2.50	4.0
24GQ2B	*	1 1/2-11 1/2	1.50	3.25	4.50	1.50	0.656	1.70	5/8-11 x 2.75	3.5
32GQ2B	*	2-11 1/2	2.00	4.00	5.25	2.00	0.781	1.70	3/4-10 x 3.00	3.0

* Consult factory.

To receive mounting hardware with flange, insert a "K" after the material designator. Mounting hardware kits are available for O-ring Face part numbers and include 4 bolts, 4 lock washers and an O-ring.

Dimensions and pressures for reference only, subject to change.



W5Q – Stainless Steel

Flat Weld Socket Block Flange Connector, Pipe
Flat Weld Socket, Pipe / Code 61 or 62
Block Flange or Pad

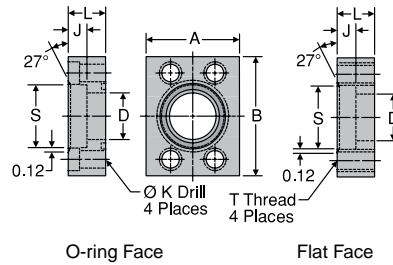


TABLE
OF
CONTENTS

VISUAL
INDEX

TUBE FITTING PART #		PIPE SIZE (in.)	FLANGE SIZE (in.)	A (in.)	B (in.)	D (in.)	J (in.)	K DRILL DIA. (in.)	L (in.)	S (in.)	T THREAD UNC-2B	MOUNTING HARDWARE SHCS	Dynamic Pressure (x 1,000 PSI) -SS
O-RING FACE	FLAT FACE												
FLAT WELD SOCKET, PIPE / CODE 61 BLOCK FLANGE OR PAD													
8W5Q1B	8W5Q1P	1/2	0.50	1.50	2.12	0.500	0.380	0.344	0.69	0.860	5/16-18	5/16-18 x 1.25	5.0
12W5Q1B	12W5Q1P	3/4	0.75	1.75	2.62	0.750	0.500	0.406	0.94	1.070	3/8-16	3/8-16 x 1.75	5.0
16W5Q1B	16W5Q1P	1	1.00	2.00	2.82	1.000	0.500	0.406	0.94	1.335	3/8-16	3/8-16 x 1.75	5.0
20W5Q1B	20W5Q1P	1 1/4	1.25	2.50	3.19	1.250	0.500	0.469	0.94	1.680	7/16-14	7/16-14 x 1.75	4.0
24W5Q1B	24W5Q1P	1 1/2	1.50	2.75	3.75	1.500	0.500	0.531	1.19	1.920	1/2-13	1/2-13 x 2.25	3.0
32W5Q1B	32W5Q1P	2	2.00	3.25	4.00	2.000	0.620	0.531	1.44	2.411	1/2-13	1/2-13 x 2.50	3.0
40W5Q1B	40W5Q1P	2 1/2	2.50	4.00	4.50	2.500	0.750	0.531	1.69	2.911	1/2-13	1/2-13 x 2.75	2.5
48W5Q1B	48W5Q1P	3	3.00	4.50	5.31	3.000	1.240	0.656	2.12	3.540	5/8-11	5/8-11 x 3.50	2.0
FLAT WELD SOCKET, PIPE / CODE 62 BLOCK FLANGE OR PAD													
8W5Q2B	8W5Q2P	1/2	0.50	1.75	2.22	0.500	0.500	0.344	0.94	0.860	5/16-18	5/16-18 x 1.50	6.0
12W5Q2B	12W5Q2P	3/4	0.75	2.00	2.81	0.750	0.500	0.406	0.94	1.070	3/8-16	3/8-16 x 1.75	6.0
16W5Q2B	16W5Q2P	1	1.00	2.25	3.19	1.000	0.500	0.469	0.94	1.335	7/16-14	7/16-14 x 1.75	6.0
20W5Q2B	20W5Q2P	1 1/4	1.25	2.75	3.75	1.250	0.500	0.531	1.19	1.672	1/2-13	1/2-13 x 2.25	6.0
24W5Q2B	24W5Q2P	1 1/2	1.50	3.25	4.50	1.500	0.500	0.656	1.44	1.920	5/8-11	5/8-11 x 2.75	6.0
32W5Q2B	32W5Q2P	2	2.00	4.00	5.25	2.000	0.620	0.781	1.69	2.411	3/4-10	3/4-10 x 3.00	6.0
40W5Q2B	40W5Q2P	2 1/2	2.50	5.00	6.88	2.500	0.620	0.906	1.94	2.911	7/8-9	7/8-9 x 3.50	6.0
48W5Q2B	48W5Q2P	3	3.00	6.00	8.50	3.000	0.620	1.156	2.44	3.540	1 1/8-7	1 1/8-7 x 4.50	6.0

To receive mounting hardware with flange, insert a "K" after the material designator. Mounting hardware kits are available for O-ring Face part numbers and include 4 bolts, 4 lock washers and an O-ring.

Dimensions and pressures for reference only, subject to change.



PQ – Stainless Steel

Block Plug

Code 61/62 Block Flange or Pad Plug

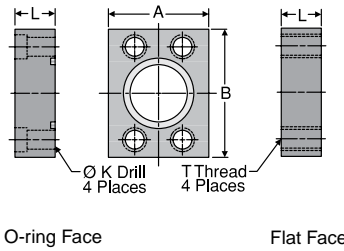


TABLE
 OF
 CONTENTS

VISUAL
 INDEX

TUBE FITTING PART #		FLANGE SIZE (in.)	A (in.)	B (in.)	K DRILL DIA. (in.)	L (in.)	T THREAD UNC-2B	MOUNTING HARDWARE SHCS	Dynamic Pressure (x 1,000 PSI) -SS
O-RING FACE	FLAT FACE								
CODE 61 BLOCK FLANGE OR PAD PLUG									
8PQ1B	8PQ1P	0.50	1.500	2.120	0.344	1.20	5/16-18	5/16-18 x 2.00	5.0
12PQ1B	12PQ1P	0.75	1.750	2.620	0.406	1.20	3/8-16	3/8-16 x 2.00	5.0
16PQ1B	16PQ1P	1.00	2.000	2.820	0.406	1.45	3/8-16	3/8-16 x 2.25	5.0
20PQ1B	20PQ1P	1.25	2.500	3.190	0.469	1.45	7/16-14	7/16-14 x 2.25	4.0
24PQ1B	24PQ1P	1.50	2.750	3.750	0.531	1.70	1/2-13	1/2-13 x 2.50	3.0
32PQ1B	32PQ1P	2.00	3.250	4.000	0.531	1.70	1/2-13	1/2-13 x 2.50	3.0
40PQ1B	40PQ1P	2.50	4.000	4.500	0.531	1.95	1/2-13	1/2-13 x 2.75	2.5
48PQ1B	48PQ1P	3.00	4.500	5.310	0.656	2.20	5/8-11	5/8-11 x 3.00	2.0
CODE 62 BLOCK FLANGE OR PAD PLUG									
8PQ2B	8PQ2P	0.50	1.750	2.220	0.344	0.94	5/16-18	5/16-18 x 1.50	6.0
12PQ2B	12PQ2P	0.75	2.000	2.810	0.406	1.19	3/8-16	3/8-16 x 2.00	6.0
16PQ2B	16PQ2P	1.00	2.250	3.190	0.492	1.44	7/16-14	7/16-14 x 2.25	6.0
20PQ2B	20PQ2P	1.25	2.750	3.750	0.531	1.44	1/2-13	1/2-13 x 2.50	6.0
24PQ2B	24PQ2P	1.50	3.250	4.500	0.656	1.69	5/8-11	5/8-11 x 2.75	6.0
32PQ2B	32PQ2P	2.00	4.000	5.250	0.781	1.69	3/4-10	3/4-10 x 3.00	6.0
40PQ2B	40PQ2P	2.50	5.000	6.880	0.906	1.94	7/8-9	7/8-9 x 3.50	6.0
48PQ2B	48PQ2P	3.00	6.000	8.500	1.190	2.44	1 1/8-7	1 1/8-7 x 3.75	6.0

To receive mounting hardware with flange, insert a "K" after the material designator. Mounting hardware kits are available for O-ring Face part numbers and include 4 bolts, 4 lock washers and an O-ring.

Dimensions and pressures for reference only, subject to change.



XHQ40

Dual Seal Flange Connector
 Dual Seal / 37° Flare

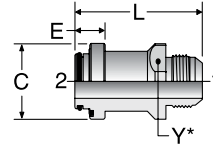


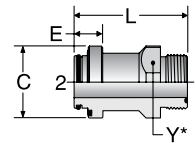
TABLE
 OF
 CONTENTS

VISUAL
 INDEX

TUBE FITTING PART #	END SIZE		C (in.)	D1 DRILL (in.)	D2 DRILL (in.)	E (in.)	L (in.)	Y (in.)	Dynamic Pressure (x 1,000 PSI)
	1 (in.)	2 DUAL SEAL							-SS
8 XHQ40	1/2	1/2	1.25	0.391	0.391	0.69	2.98	1.00	7.2
16 XHQ40	1	1	1.88	0.844	0.844	0.75	3.18	1.63	4.8
24 XHQ40	1 1/2	1 1/2	2.50	1.310	1.310	1.00	4.00	2.13	3.6

LOHQ40

Dual Seal Flange Connector
 Dual Seal / ORFS

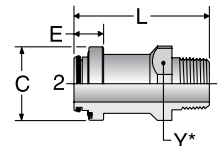


TUBE FITTING PART #	END SIZE		C (in.)	D1 DRILL (in.)	D2 DRILL (in.)	E (in.)	L (in.)	Y (in.)	Dynamic Pressure (x 1,000 PSI)
	1 (in.)	2 DUAL SEAL							-SS
8 LOHQ40	1/2	1/2	1.25	0.374	0.374	0.69	2.83	1.00	7.5
16 LOHQ40	1	1	1.88	0.807	0.807	0.75	2.96	1.63	6.0
24 LOHQ40	1 1/2	1 1/2	2.50	1.260	1.260	1.00	3.61	2.13	5.0

L

FHQ40

Dual Seal Flange Connector
 Dual Seal / Male NPTF



TUBE FITTING PART #	END SIZE		C (in.)	D1 DRILL (in.)	D2 DRILL (in.)	E (in.)	L (in.)	Y (in.)	Dynamic Pressure (x 1,000 PSI)
	1 (in.)	2 DUAL SEAL							-SS
8 FHQ40	1/2	1/2	1.25	0.500	0.500	0.69	3.18	1.00	7.2
16 FHQ40	1	1	1.88	0.938	0.938	0.75	3.45	1.63	5.4
24 FHQ40	1 1/2	1 1/2	2.50	1.312	1.312	1.00	4.10	2.13	3.6

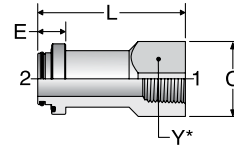
Dimensions and pressures for reference only, subject to change.

TABLE
 OF
 CONTENTS

VISUAL
 INDEX

GHQ40

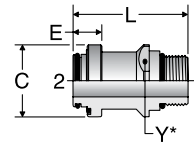
Dual Seal Flange Connector
 Dual Seal / Female NPTF



TUBE FITTING PART #	END SIZE		C (in.)	D1 DRILL (in.)	D2 DRILL (in.)	E (in.)	L (in.)	Y (in.)	Dynamic Pressure (x 1,000 PSI)
	1 (in.)	2 DUAL SEAL							-SS
8 GHQ40	1/2	1/2	1.25	0.500	0.500	0.69	2.96	1.00	6.0
16 GHQ40	1	1	1.88	0.938	0.938	0.75	3.94	1.63	3.6
24 GHQ40	1 1/2	1 1/2	2.50	1.312	1.312	1.00	4.81	2.25	3.0

F5OHQ40

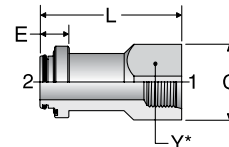
Dual Seal Flange Connector
 Dual Seal / Male SAE-ORB



TUBE FITTING PART #	END SIZE		C (in.)	D1 DRILL (in.)	D2 DRILL (in.)	E (in.)	L (in.)	Y (in.)	Dynamic Pressure (x 1,000 PSI)
	1 (in.)	2 DUAL SEAL							-SS
8 F5OHQ40	1/2	1/2	1.25	0.394	0.394	0.69	2.87	1.00	6.0
16 F5OHQ40	1	1	1.88	0.844	0.844	0.75	3.00	1.63	4.0
24 F5OHQ40	1 1/2	1 1/2	2.50	1.312	1.312	1.00	3.65	2.17	3.0

G5HQ40

Dual Seal Flange Connector
 Dual Seal / Female SAE-ORB



TUBE FITTING PART #	END SIZE		C (in.)	D1 DRILL (in.)	D2 DRILL (in.)	E (in.)	L (in.)	Y (in.)	Dynamic Pressure (x 1,000 PSI)
	1 (in.)	2 DUAL SEAL							-SS
8 G5HQ40	1/2	1/2	1.25	0.406	0.406	0.69	2.77	1.00	5.0
16 G5HQ40	1	1	1.88	0.938	0.938	0.75	3.72	1.63	3.5
24 G5HQ40	1 1/2	1 1/2	2.50	1.312	1.312	1.00	4.59	2.25	2.5

Dimensions and pressures for reference only, subject to change.



W7HQ40

Dual Seal Flange Connector
Dual Seal / Socket Weld Pipe

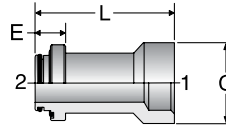


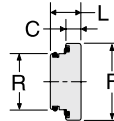
TABLE
OF
CONTENTS

VISUAL
INDEX

TUBE FITTING PART #	END SIZE		C (in.)	D1 DRILL (in.)	D2 DRILL (in.)	E (in.)	L (in.)	Dynamic Pressure (x 1,000 PSI)
	1 PIPE	2 DUAL SEAL						-SS
	8 W7HQ40	1/2						1/2
16 W7HQ40	1	1	1.88	0.938	0.938	0.75	3.44	7.5
24 W7HQ40	1 1/2	1 1/2	2.50	1.312	1.312	1.00	4.43	7.5

PQ40

Dual Seal Flange Connector
Dual Seal Plug



TUBE FITTING PART #	END SIZE		F (in.)	C (in.)	L (in.)	R (in.)	Dynamic Pressure (x 1,000 PSI)
	2 DUAL SEAL	-SS					
	8 PQ40	1/2					1.25
16 PQ40	1	1.88	0.38	0.75	1.37	7.5	
24 PQ40	1 1/2	2.50	0.50	1.00	1.75	7.5	

L

Q4 Insert

Dual Seal Flange Insert



TUBE FITTING PART #	END SIZE		L (in.)	C (in.)	Dynamic Pressure (x 1,000 PSI)
	2 DUAL SEAL	-SS			
	8 Q4 INSERT	1/2			1.00
16 Q4 INSERT	1	1.00	1.37	7.5	
24 Q4 INSERT	1 1/2	1.00	1.74	7.5	

Dimensions and pressures for reference only, subject to change.

VISUAL
INDEX


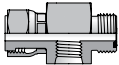
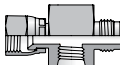
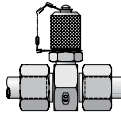










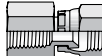
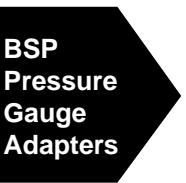

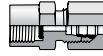


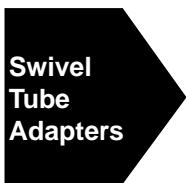
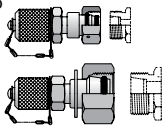

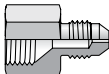


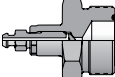
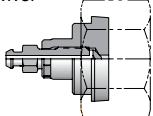
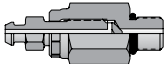
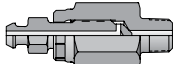
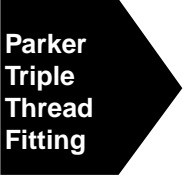


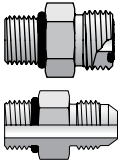


Diagnostic, Orifice, Bleed Adapters and Specialty Fittings

M



ENGINEERING YOUR SUCCESS.

 <p>Diagnostic Tees</p>	<p>LOHL6G5TP ORFS Swivel / ORFS / SAE-ORB</p>  <p>M5</p>	<p>XHX6G5TP 37° Swivel / 37° Flare / SAE-ORB</p>  <p>M5</p>	<p>GMA3 EO Tube / EO Tube / EMA-3 Diagnostic Tip</p>  <p>M5</p>	 <p>Diagnostic Tee Port Adapters and Plugs</p>	<p>F50G SAE-ORB / NPTF</p>  <p>F13</p>
<p>P50N Hex Head Plug</p>  <p>F25</p>	<p>HP50N Hollow Hex Plug</p>  <p>F26</p>	 <p>NPT / SAE-ORB Pressure Gauge Adapters</p>	<p>G5L SAE-ORB Gauge / ORFS</p>  <p>M7</p>	<p>G65L SAE-ORB Gauge / ORFS Swivel</p>  <p>M7</p>	<p>GLO NPT Gauge / ORFS</p>  <p>M7</p>
<p>G6L NPT Gauge / ORFS Swivel</p>  <p>M7</p>	<p>GTX NPT Gauge / 37° Flare</p>  <p>M7</p>	<p>G6X NPT Gauge / 37° Swivel</p>  <p>M7</p>	 <p>BSP Pressure Gauge Adapters</p>	<p>MAVE BSPP Gauge / EO Swivel</p>  <p>M6</p>	<p>MAV BSPP Gauge / EO</p>  <p>M6</p>
<p>G4MXSMO BSPP Gauge / 37° Flare</p>  <p>M6</p>	<p>G4MLOSMO BSPP Gauge / ORFS</p>  <p>M6</p>	 <p>Swivel Tube Adapters</p>	<p>VKA3 EO Swivel / Diagnostic Tip</p>  <p>M8</p>	 <p>Orifice Fittings</p>	<p>XHX7 37° Seat / 37° Flare with Orifice</p>  <p>M9</p>
<p>LOHL6 ORFS Swivel with Orifice / ORFS</p>  <p>M9</p>	 <p>ORFS / Port Bleed Adapters</p>	<p>PNLOBA Bleed Screw / ORFS</p>  <p>M10</p>	<p>FNLBA Bleed Screw / ORFS Swivel</p>  <p>M10</p>	<p>P50NBA Bleed Screw / SAE-ORB</p>  <p>M10</p>	<p>HPBA Bleed Screw / NPT</p>  <p>M10</p>
 <p>Parker Triple Thread Fitting</p>	<p>0109 NPTF / PTT 30° Flare</p>  <p>M11</p>	 <p>Screen Fittings</p>	<p>Screen Fittings</p>  <p>M12</p>		

Introduction

Parker offers a line of specialty-type adapters specifically designed for diagnostic, fixed flow control and bleeding applications.

Diagnostic products consist of a line of in-line diagnostic tees, pressure gauge connectors and diagnostic tips. These products have been developed to work in conjunction with electronic diagnostic products available from Parker's Quick Coupling Division and other mechanical pressure and temperature sensing equipment. Some products can be used for fluid sampling and bleeding purposes as well.

Parker offers a standard and custom line of fixed flow control orifice fittings. These products are available as standard in two Parker product series — ORFS and 37° flare, and as a custom option in virtually any orifice size, fitting series, size, material and configuration.

Parker's bleed adapters are designed to remove entrapped air from a hydraulic system. A common problem in hydraulic systems is trapped air and the subsequent spillage of hydraulic oil while removing components to bleed air from lines under pressure. Parker's bleed adapters provide a quick, clean, and simple method of bleeding entrapped air from hydraulic systems.

Parker offers a limited line of PTT (Parker Triple Thread) 30° flare adapters for transportation markets. Lastly, Parker offers a line of screen fittings as a final measure of protection.

Diagnostic Fittings and Adapters

In-Line Diagnostic Tees

Features

- Designed around the two most common hydraulic tube/hose interfaces: ORFS (Seal-Lok) and 37° flare (JIC / Triple-Lok) (see A)
- ORFS and 37° flare swivel feature offers unlimited positioning without displacing port adapter (see B)
- Uses elastomeric sealing: SAE -4 (7/16-20 UNF) port as universal diagnostic port per SAE J1926-1 / ISO 11926 (see C)
- Enlarged and lengthened body hex ensures that diagnostic port offers full thread engagement and pressure capability (see D)
- Adaptable to Parker's line of diagnostic and fluid sampling tips including: EMA3, PD and PDFS, as well as various direct connecting electronic/mechanical pressure gauges*
- Designed to complement Parker's line of Senso-Control® electronic diagnostic equipment

*Diagnostic and sampling tips EMA3, PD and PDFS series are available from Parker's Quick Coupling Division (tel. 763-544-7781 and/or www.parker.com/quickcouplings)



Fig. M1 — Parker offers a full line of diagnostic, orifice, bleed adapters and specialty fittings

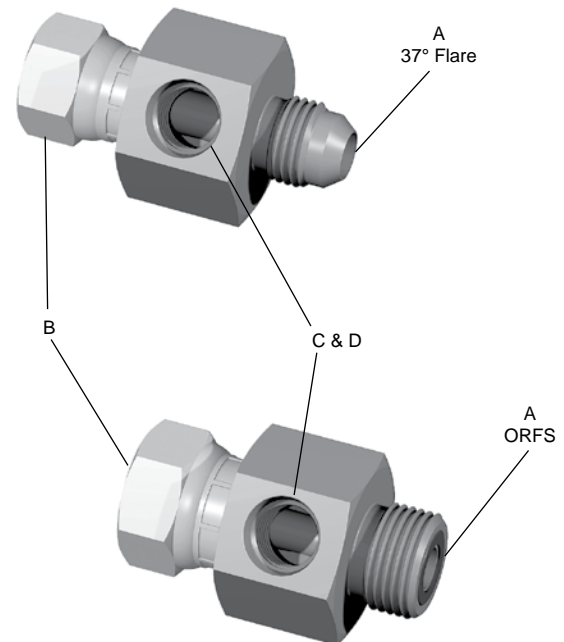


Fig. M2 — Parker's XHX6G5TP (top) and LOHL6G5TP (bottom) in-line diagnostic tees

VISUAL
INDEX

M

Applications

- In-line pressure and temperature measurements
- In-line oil sampling to evaluate hydraulic contamination, caused by problems with filtration or internal components
- In-field diagnostics without removal of port adapters. Simply remove hose swivel and insert in-line tee.
- Permanent or temporary OEM and MRO diagnostic applications:
 - Where traditional in-port diagnostic tips cannot be located or easily accessed
 - Where OEM diagnostic tips have not been installed
 - Non-traditional diagnostic locations (portable)
 - Where port threads are not compatible with standard diagnostic tips
- To eliminate reducer bushings and couplings typically required to neck down from larger size connections to smaller connections; e.g. reductions required for a gauge, diagnostic tip, bleed adapter, or tube/hose connection.

Assembly Instructions

The body of the diagnostic tee can be used repeatedly for 10-20 remakes at full rated pressure and assembly torque. See Tables M1 and M2 for recommended swivel nut assembly torques.

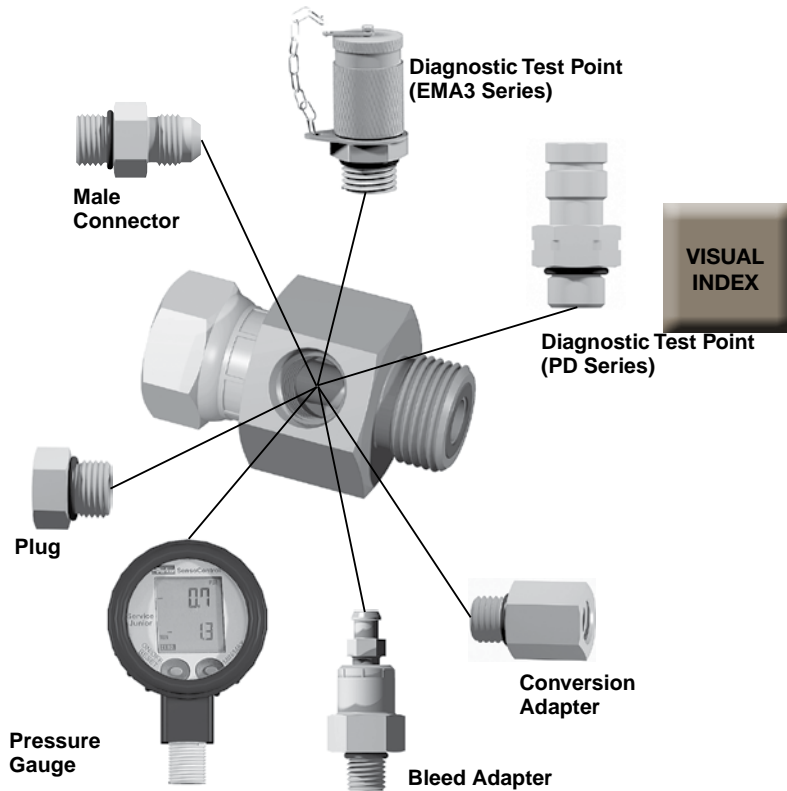


Fig. M3 — Illustration showing the versatility of Parker's diagnostic tee product line

Part Number	Assembly Torque (+10%-0)	
	in.-lb.	ft.-lb.
4-4 XHX6G5TP	130	11
6-4 XHX6G5TP	235	20
8-4 XHX6G5TP	525	43
10-4 XHX6G5TP	—	55
12-4 XHX6G5TP	—	80
16-4 XHX6G5TP	—	115
20-4 XHX6G5TP	—	160
24-4 XHX6G5TP	—	185

Note: Assembly values are for dry, unlubricated swivel nut connections

Table M1 — Assembly Torques (Swivel nut) for Diagnostic Tees

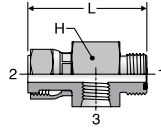
Part Number	Assembly Torque (+10%-0)	
	in.-lb.	ft.-lb.
4-4 LHL6G5TP	220	18
6-4 LHL6G5TP	360	30
8-4 LHL6G5TP	480	40
10-4 LHL6G5TP	—	60
12-4 LHL6G5TP	—	85
14-4 LHL6G5TP	—	100
16-4 LHL6G5TP	—	110
20-4 LHL6G5TP	—	150
24-4 LHL6G5TP	—	230
32-4 LHL6G5TP	—	360

Table M2 — Assembly Torques (Swivel nut) for Diagnostic Tees

Dimensions and pressures for reference only, subject to change.

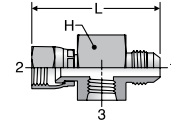
LOHL6G5TP

Gauge Port Tee
ORFS / ORFS Swivel /
SAE-ORB



XHX6G5TP

Gauge Port Tee
37° Flare / 37° Swivel /
SAE-ORB



TUBE FITTING PART #	END SIZE			H (in.)	L (in.)	Pressure (x 1,000 PSI)	
	1 (in.)	2 (in.)	3 UN/UNF			Static -S	Dynamic -S
4-4 LOHL6G5TP	1/4	1/4	7/16-20	1-1/16	1.83	10.0	6.0
6-4 LOHL6G5TP	3/8	3/8	7/16-20	1-1/16	1.95	10.0	6.0
8-4 LOHL6G5TP	1/2	1/2	7/16-20	1-1/16	2.18	10.0	6.0
10-4 LOHL6G5TP	5/8	5/8	7/16-20	1-1/8	2.40	10.0	6.0
12-4 LOHL6G5TP	3/4	3/4	7/16-20	1-1/4	2.59	10.0	6.0
16-4 LOHL6G5TP	1	1	7/16-20	1-1/2	2.85	9.5	6.0
20-4 LOHL6G5TP	1 1/4	1 1/4	7/16-20	1-3/4	3.07	6.5	5.0
24-4 LOHL6G5TP	1 1/2	1 1/2	7/16-20	2-1/8	3.22	5.0	4.0

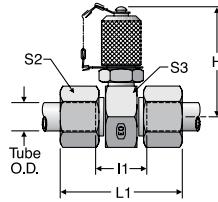
Note: Fluorocarbon O-rings are available upon request.

TUBE FITTING PART #	END SIZE			H (in.)	L (in.)	Pressure (x 1,000 PSI)	
	1 (in.)	2 (in.)	3 UN/UNF			Static -S	Dynamic -S
4-4 XHX6G5TP	1/4	1/4	7/16-20	1-1/16	1.99	10.0	6.0
6-4 XHX6G5TP	3/8	3/8	7/16-20	1-1/16	2.08	6.5	5.0
8-4 XHX6G5TP	1/2	1/2	7/16-20	1-1/16	2.30	6.5	5.0
10-4 XHX6G5TP	5/8	5/8	7/16-20	1-1/8	2.49	6.5	5.0
12-4 XHX6G5TP	3/4	3/4	7/16-20	1-1/4	2.66	6.5	5.0
16-4 XHX6G5TP	1	1	7/16-20	1-1/2	2.99	6.0	4.5
20-4 XHX6G5TP	1 1/4	1 1/4	7/16-20	1-3/4	3.33	6.0	4.5
24-4 XHX6G5TP	1 1/2	1 1/2	7/16-20	2	3.71	5.5	4.0

VISUAL
INDEX

GMA3

Diagnostic Tip
EO Tube / EO Tube /
M16 x 2.0 Integrated Tip



TUBE FITTING PART #	END SIZE (mm)	H (mm)	I 1 (mm)	L1 (mm)	S2 (mm)	S3 (mm)	Pressure (x 1,000 PSI)	
							Static CF	Dynamic CF
GMA3/06L	6	49	21	51	14	24	7.2	4.5
GMA3/08L	8	49	21	51	17	24	7.2	4.5
GMA3/10L	10	49	23	53	19	24	7.2	4.5
GMA3/12L	12	50	23	53	22	27	5.8	4.5
GMA3/15L	15	52	25	55	27	30	5.8	4.5
GMA3/18L	18	53	24	57	32	32	5.8	4.5
GMA3/22L	22	55	28	61	36	36	3.6	2.3
GMA3/28L	28	57	28	61	41	41	3.6	2.3
GMA3/35L	35	60	26	69	50	46	3.6	2.3
GMA3/42L	42	64	25	71	60	55	3.6	2.3
GMA3/06S	6	49	25	55	17	24	10.1	9.1
GMA3/08S	8	49	25	55	19	24	10.1	9.1
GMA3/10S	10	49	24	57	22	24	10.1	9.1
GMA3/12S	12	49	24	57	24	24	10.1	9.1
GMA3/14S	14	50	27	63	27	27	10.1	9.1
GMA3/16S	16	52	26	63	30	30	9.1	5.8
GMA3/20S	20	55	26	69	36	36	9.1	5.8
GMA3/25S	25	57	27	75	46	41	9.1	5.8
GMA3/30S	30	60	28	81	50	46	6.1	5.8
GMA3/38S	38	64	29	91	60	55	6.1	4.5

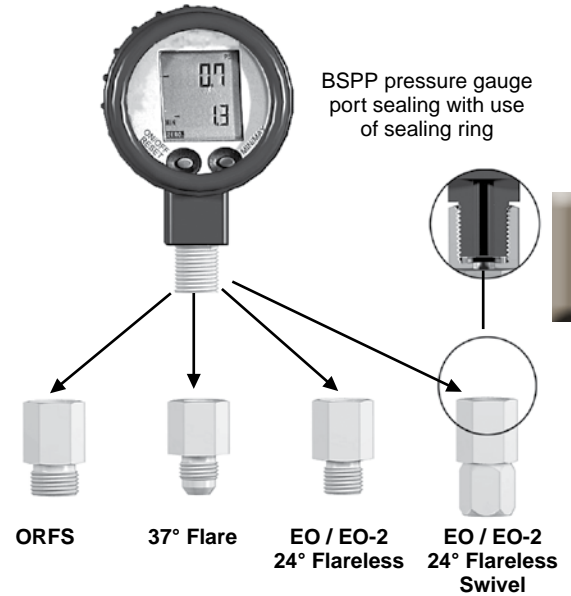
To specify EO-2, add "Z" between tube size and series.
Example: GMA3/28ZLA3C

Dimensions and pressures for reference only, subject to change.



BSPP Diagnostic Pressure Gauge Adapters

Parker's BSPP direct-connect pressure gauge adapters are available in the most common tube/hose connections — ORFS, 37° Flare (JIC) and 24° Metric Flareless (DIN 2353). European pressure gauges often utilize BSPP threads on the pressure gauges (manometers). Sealing is achieved at the bottom of the port with a sealing washer as shown in the illustration on the right.



VISUAL INDEX

BSPP Pressure Gauge Adapters

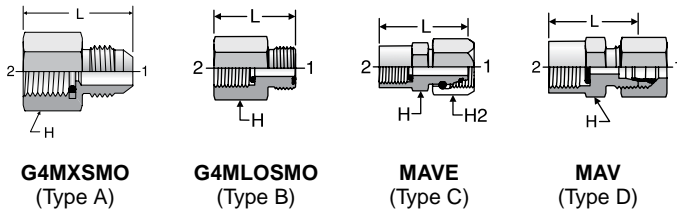


Fig. M4 — BSPP pressure gauge connections

TUBE FITTING PART #	TYPE	END SIZE		L (mm)	H BODY HEX (mm)	H2 NUT HEX (mm)	Pressure (x 1,000 PSI)	
		1 (in.)	2 BSPP				Static S	Dynamic S
4-4G4MXSMO	A	1/4	1/4-19	31.0	17	—	5.0	5.0
6G4MXSMO	A	3/8	1/4-19	28.0	17	—	5.0	5.0
8-4G4MXSMO	A	1/2	1/4-19	31.0	19	—	5.0	5.0
4-4G4MLOSMO	B	1/4	1/4-19	26.8	17	—	5.0	5.0
6G4MLOSMO	B	3/8	1/4-19	28.2	19	—	5.0	5.0
8-4G4MLOSMO	B	1/2	1/4-19	29.8	22	—	5.0	5.0
		1 (mm)	2 BSPP				Static CF	Dynamic CF
MAVE06LR	C	6	1/4-19	35.5	19	14	4.6	4.6
MAVE08LR	C	8	1/4-19	35.5	19	17	4.6	4.6
MAVE10LR	C	10	1/4-19	36.0	19	19	4.6	4.6
MAVE06SR	C	6	1/2-14	42.5	27	17	9.1	9.1
MAVE08SR	C	8	1/2-14	43.0	27	19	9.1	9.1
MAVE10SR	C	10	1/2-14	43.5	27	22	9.1	9.1
MAVE12SR	C	12	1/2-14	45.0	27	24	9.1	9.1
MAVE06SR1/4	C	6	1/4-19	35.5	19	17	9.1	9.1
MAVE08SR1/4	C	8	1/4-19	35.5	19	19	9.1	9.1
MAVE10SR1/4	C	10	1/4-19	39.0	19	22	9.1	9.1
MAVE12SR1/4	C	12	1/4-19	39.0	19	24	9.1	9.1
MAV04LLR	D	4	1/4-19	33.0	19	10	1.4	1.4
MAV06LR	D	6	1/4-19	37.0	19	14	4.5	4.5
MAV08LR	D	8	1/4-19	37.0	19	17	4.5	4.5
MAV10LR	D	10	1/4-19	38.0	19	19	4.5	4.5
MAV12LR	D	12	1/4-19	38.0	19	22	4.5	4.5
MAV06SR	D	6	1/2-14	46.0	27	17	9.1	9.1
MAV08SR	D	8	1/2-14	46.0	27	19	9.1	9.1
MAV10SR	D	10	1/2-14	47.0	27	22	9.1	9.1
MAV12SR	D	12	1/2-14	47.0	27	24	9.1	9.1

Note: MAV supplied as standard with PSR +M nut (EO assembled)

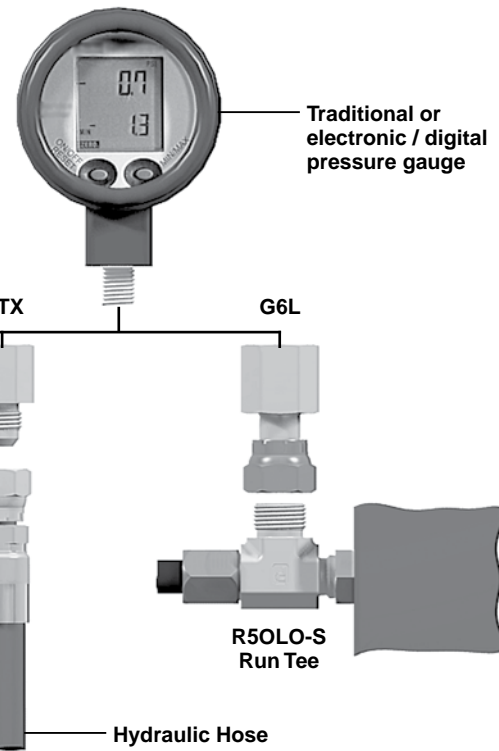
* BSPP Pressure Gauge Connection requires seal. 1/4" replacement seal P/N: M25180.

** BSPP Pressure Gauge Connection requires seal. 1/4" replacement seal P/N: DK11/4CFX, 1/2" replacement seal P/N: DK11/2CFX.

Dimensions and pressures for reference only, subject to change.

NPT and SAE-ORB Diagnostic Pressure Gauge Adapters

Parker's NPT and SAE-ORB direct-connect pressure gauge adapters are available in the most common North American tube/hose connections — ORFS and 37° Flare (JIC). North American pressure gauge manufacturers offer gauges primarily with NPT and some with SAE-ORB port stud options. These 37° flare and ORFS connectors are designed to attach pressure gauges to hose swivel ends or directly to run / branch tees for in-line diagnostic applications as shown on the right.



VISUAL INDEX

NPT / SAE Pressure Gauge Adapters

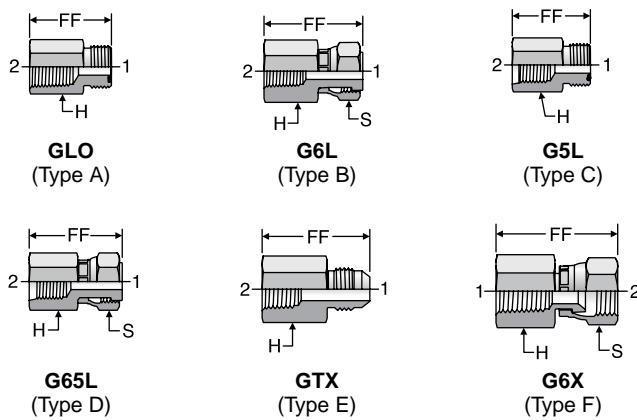


Fig. M5 — Typical applications for NPT pressure gauge adapters. Illustrations show direct hose connections and Run Tee connection.

M

TUBE FITTING PART #	TYPE	END SIZE		FF (in.)	H BODY HEX (in.)	S SWIVEL NUT HEX (in.)	Pressure (x 1,000 PSI)	
		1 (in.)	2 NPT				Static -S	Dynamic -S
		4-4 GLO	A				1/4	1/4-18
6 GLO	A	3/8	1/4-18	1.30	3/4	—	8.0	6.0
8-4 GLO	A	1/2	1/4-18	1.20	7/8	—	9.5	6.0
4-4 G6L	B	1/4	1/4-18	1.48	3/4	11/16	9.5	6.0
6 G6L	B	3/8	1/4-18	1.60	7/8	13/16	8.0	6.0
8-4 G6L	B	1/2	1/4-18	1.75	7/8	15/16	9.5	6.0
		UN/UNF						
4 G5LO	C	1/4	7/16-20	1.10	3/4	—	6.0	5.0
6-4 G5LO	C	3/8	7/16-20	1.08	3/4	—	6.0	5.0
8-4 G5LO	C	1/2	7/16-20	0.78	7/8	—	6.0	5.0
4 G65L	D	1/4	7/16-20	1.38	11/16	11/16	6.0	5.0
6-4 G65L	D	3/8	7/16-20	1.51	3/4	13/16	6.0	5.0
8-4 G65L	D	1/2	7/16-20	1.57	7/8	15/16	6.0	5.0
		NPT						
2 GTX	E	1/8	1/8-27	1.13	9/16	—	10.0	5.0
3 GTX	E	3/16	1/8-27	1.13	9/16	—	10.0	5.0
4-4 GTX	E	1/4	1/4-18	1.39	3/4	—	10.0	5.0
4 GTX	E	1/4	1/8-27	1.19	9/16	—	10.0	5.0
6-2 GTX	E	3/8	1/8-27	1.13	5/8	—	10.0	5.0
6 GTX	E	3/8	1/4-18	1.41	3/4	—	10.0	5.0
8-4 GTX	E	1/2	1/4-18	1.41	13/16	—	8.0	5.0
4-4 G6X	F	1/4	1/4-18	9/16	3/4	9/16	9.5	6.0
4 G6X	F	1/4	1/8-27	9/16	9/16	9/16	10.0	7.5
6 G6X	F	3/8	1/4-18	11/16	3/4	11/16	6.0	5.0

Dimensions and pressures for reference only, subject to change.

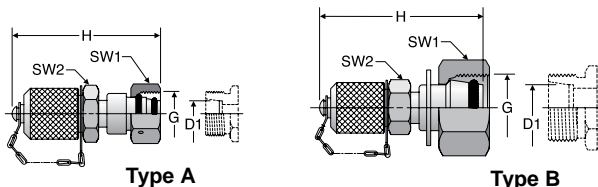
EO Diagnostic Swivels

EO Diagnostic Swivels are commonly used on EO tees (24° flareless - DIN 2353) where periodic pressure and temperature checks are required. The M16 x 2 diagnostic tip mates with the SMA3 diagnostic nose offered by Parker's Quick Coupling Division.

VISUAL
 INDEX

VKA3

M16 x 2.0 Diagnostic
 Tip / EO Swivel

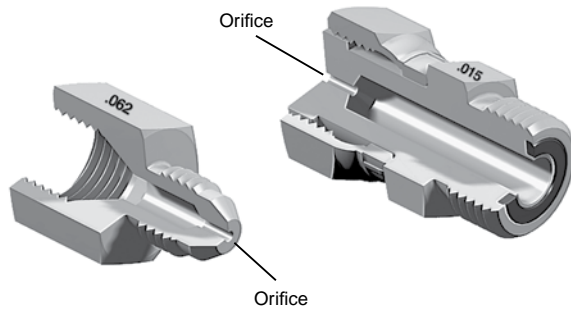


TUBE FITTING PART # STEEL	TYPE	D1 TUBE O.D. (mm)	G Metric	H REF. (mm)	SW1 (mm)	SW2 (mm)	Pressure (x 1,000 PSI)	
							Static	Dynamic
							CF	CF
VKA3/06L	A	6	M12 x 1.5	55	17	17	7.2	4.5
VKA3/08L	A	8	M14 x 1.5	51	17	17	7.2	4.5
VKA3/10L	A	10	M16 x 1.5	53	17	19	7.2	4.5
VKA3/12L	A	12	M18 x 1.5	53	17	22	5.8	4.5
VKA3/15L	B	15	M22 x 1.5	59	17	27	5.8	4.5
VKA3/18L	B	18	M26 x 1.5	59	17	32	5.8	4.5
VKA3/22L	B	22	M30 x 2	60	17	39	3.6	2.3
VKA3/28L	B	28	M36 x 2	64	17	41	3.6	2.3
VKA3/35L	B	35	M45 x 2	71	17	50	3.6	2.3
VKA3/42L	B	42	M52 x 2	72	17	60	3.6	2.3
VKA3/06S	A	6	M14 x 1.5	50	17	17	10.1	9.1
VKA3/08S	A	8	M16 x 1.5	52	17	19	10.1	9.1
VKA3/10S	A	10	M18 x 1.5	53	17	22	10.1	9.1
VKA3/12S	A	12	M20 x 1.5	54	19	24	10.1	9.1
VKA3/14S	B	14	M22 x 1.5	59	17	27	10.1	9.1
VKA3/16S	B	16	M24 x 1.5	58	17	30	9.1	5.8
VKA3/20S	B	20	M30 x 2	65	17	36	9.1	5.8
VKA3/25S	B	25	M36 x 2	68	17	46	9.1	5.8
VKA3/30S	B	30	M42 x 2	74	17	50	6.0	5.8
VKA3/38S	B	38	M52 x 2	81	17	60	6.0	4.5

Dimensions and pressures for reference only, subject to change.

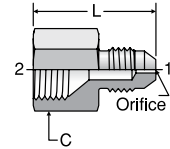
Orifice Fittings

These compact and cost effective orifice adapters allow OEMs to pre-set, at the factory, a specified orifice in specific hydraulic tube or hose lines. Costly flow control valves can be eliminated or minimized in a system by selecting the proper orifice sizes at the factory. OEMs can also be assured that end users are not adjusting the factory established flow and speed characteristics of the hydraulic system.



XHX7 Orifice

In-Line Orifice Connector
37° Flare / Female 37° Seat



TUBE FITTING PART #	END SIZE 1 & 2 (in.)	C HEX (in.)	ORIFICE (in.)	L (in.)	Pressure (x 1,000 PSI)	
					Static -S	Dynamic -S
4 XHX7-S .015 Orifice	1/4	9/16	.015	1.10	10.0	5.0
4 XHX7-S .031 Orifice	1/4	9/16	.031	1.10	10.0	5.0
4 XHX7-S .047 Orifice	1/4	9/16	.047	1.10	10.0	5.0
4 XHX7-S .062 Orifice	1/4	9/16	.062	1.10	10.0	5.0
4 XHX7-S .078 Orifice	1/4	9/16	.078	1.10	10.0	5.0
4 XHX7-S .094 Orifice	1/4	9/16	.094	1.10	10.0	5.0
6 XHX7-S .015 Orifice	3/8	11/16	.015	1.18	10.0	5.0
6 XHX7-S .031 Orifice	3/8	11/16	.031	1.18	10.0	5.0
6 XHX7-S .047 Orifice	3/8	11/16	.047	1.18	10.0	5.0
6 XHX7-S .062 Orifice	3/8	11/16	.062	1.18	10.0	5.0
6 XHX7-S .078 Orifice	3/8	11/16	.078	1.18	10.0	5.0
6 XHX7-S .094 Orifice	3/8	11/16	.094	1.18	10.0	5.0
8 XHX7-S .015 Orifice	1/2	7/8	.015	1.32	8.5	5.0
8 XHX7-S .031 Orifice	1/2	7/8	.031	1.32	8.5	5.0
8 XHX7-S .047 Orifice	1/2	7/8	.047	1.32	8.5	5.0
8 XHX7-S .062 Orifice	1/2	7/8	.062	1.32	8.5	5.0
8 XHX7-S .078 Orifice	1/2	7/8	.078	1.32	8.5	5.0
8 XHX7-S .094 Orifice	1/2	7/8	.094	1.32	8.5	5.0



The Parker Advantage

- 37° flare and ORFS configurations as standard
- Three standard body sizes available: 1/4" 3/8", and 1/2"
- Available in commonly accepted pre-set orifice sizes as shown on accompanying tables
- Designed for permanent or temporary installation
- Can be installed in-line into hydraulic system by simply connecting between hose swivel and adapter
- Orifice size is permanently stamped on body
- Can eliminate costly flow control valves

Applications:

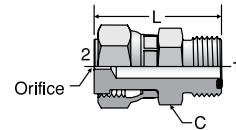
- Fixed rotation speed for hydraulic motors
- Fixed speed on cylinder extend or retract

Direct Port Orifice Fittings:

Available as a custom product, Parker also offers a line of orifice adapters that will replace a traditional port adapter.

LOHL6 Orifice

In-Line Orifice Connector
ORFS Swivel / ORFS



TUBE FITTING PART #	END SIZE 1 & 2 (in.)	C HEX (in.)	ORIFICE (in.)	L (in.)	Pressure (x 1,000 PSI)	
					Static -S	Dynamic -S
4 LOHL6-S .015 Orifice	1/4	5/8	.015	1.33	12.0	9.2
4 LOHL6-S .031 Orifice	1/4	5/8	.031	1.33	12.0	9.2
4 LOHL6-S .047 Orifice	1/4	5/8	.047	1.33	12.0	9.2
4 LOHL6-S .062 Orifice	1/4	5/8	.062	1.33	12.0	9.2
4 LOHL6-S .078 Orifice	1/4	5/8	.078	1.33	12.0	9.2
4 LOHL6-S .094 Orifice	1/4	5/8	.094	1.33	12.0	9.2
6 LOHL6-S .015 Orifice	3/8	3/4	.015	1.44	12.0	9.2
6 LOHL6-S .031 Orifice	3/8	3/4	.031	1.44	12.0	9.2
6 LOHL6-S .047 Orifice	3/8	3/4	.047	1.44	12.0	9.2
6 LOHL6-S .062 Orifice	3/8	3/4	.062	1.44	12.0	9.2
6 LOHL6-S .078 Orifice	3/8	3/4	.078	1.44	12.0	9.2
6 LOHL6-S .094 Orifice	3/8	3/4	.094	1.44	12.0	9.2
8 LOHL6-S .015 Orifice	1/2	7/8	.015	1.67	12.0	9.2
8 LOHL6-S .031 Orifice	1/2	7/8	.031	1.67	12.0	9.2
8 LOHL6-S .047 Orifice	1/2	7/8	.047	1.67	12.0	9.2
8 LOHL6-S .062 Orifice	1/2	7/8	.062	1.67	12.0	9.2
8 LOHL6-S .078 Orifice	1/2	7/8	.078	1.67	12.0	9.2
8 LOHL6-S .094 Orifice	1/2	7/8	.094	1.67	12.0	9.2



Dimensions and pressures for reference only, subject to change.

Bleed Adapters

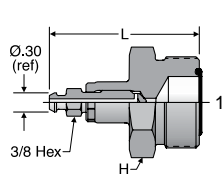
Entrapped air is a major contributor to inefficient operation. Typically, bleeding hydraulic systems is done by “cracking” a connection to “bleed off” the entrapped air. This practice is not recommended, especially in larger size fittings where high forces can exist. Parker’s bleed adapters are especially beneficial in applications where elastomeric seals (O-rings) can be extruded and/or damaged during bleeding such as with Parker’s Seal-Lok fittings.

Parker’s bleed adapters are designed specifically for installation directly to ORFS (O-Ring Face Seal) type fittings or into SAE/NPT manifolds and valves where bleeding is often required.

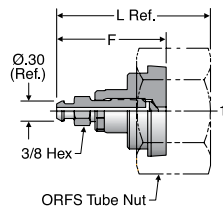
Product Characteristics

- Bleed hydraulic systems without “cracking” hydraulic connections
- Uses standard automotive bleed screw design
- Bleed screw is permanently crimped into body housing, for blowout prevention
- In-port options with SAE and NPT male studs
- Tube/hose connection options to male and female ORFS

ORFS Bleed Adapters



PNLOBA



FNLBA

ORFS Tube Nut sold separately

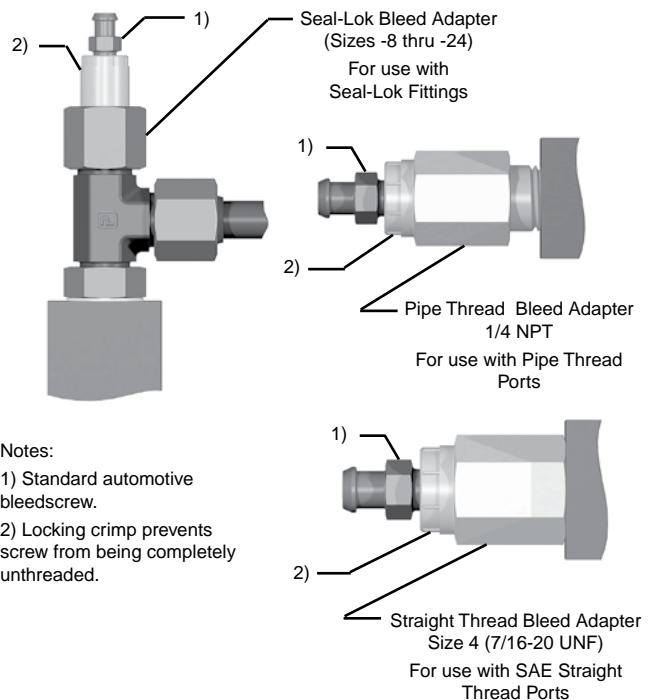
TUBE FITTING PART #	END SIZE 1 (in.)	F (in.)	H (in.)	L (in.)	Pressure (x 1,000 PSI)	
					Static -S	Dynamic -S
4 PNLOBA	1/4	-	11/16	1.90	12.0	9.2
6 PNLOBA	3/8	-	3/4	1.97	12.0	9.2
8 PNLOBA	1/2	-	7/8	2.07	12.0	9.2
10 PNLOBA	5/8	-	1 1/16	2.19	11.0	6.0
12 PNLOBA	3/4	-	1 1/4	2.27	11.0	6.0
16 PNLOBA	1	-	1 1/2	2.35	9.5	6.0
20 PNLOBA	1 1/4	-	1 3/4	2.41	8.0	6.0
24 PNLOBA	1 1/2	-	2 1/8	2.48	6.5	5.0
8 FNLBA	1/2	1.63	15/16	2.07	12.0	9.2
10 FNLBA	5/8	1.63	1 1/8	2.17	11.0	6.0
12 FNLBA	3/4	1.63	1 3/8	2.21	11.0	6.0
16 FNLBA	1	1.63	1 5/8	2.21	9.5	6.0
20 FNLBA	1 1/4	1.63	1 7/8	2.21	8.0	6.0
24 FNLBA	1 1/2	1.63	2 1/4	2.21	6.5	5.0

Bleeding Hydraulic Systems with Parker Bleed Adapters

Whenever possible, the bleed adapter should be mounted at the highest point within the hydraulic system. The trapped air can be relieved while the system is running at low pressure. To bleed, loosen the bleed screw 1/2 turn counterclockwise. After the hydraulic fluid begins to run freely from the bleed screw, the bleed screw should be re-tightened.

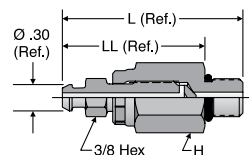
Bleed Screw Tightening Torque: 35-40 in.-lbs.

Warning: When bleeding hydraulic fluid, operate the system below 500 psi. To avoid injury, ensure that all persons are clear of the path of discharge. Another recommended practice is to attach a section of hose over the bleed screw/adapter to direct oil away from the area and to reduce oil spillage.

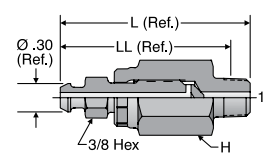


- Notes:
- 1) Standard automotive bleedscrew.
 - 2) Locking crimp prevents screw from being completely unthreaded.

Port Bleed Adapters



4 P5ONBA



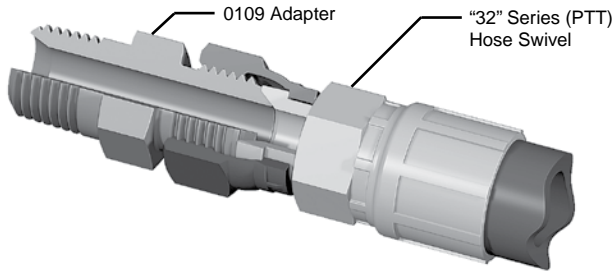
1/4 HPBA

TUBE FITTING PART #	END SIZE 1	BODY HEX (in.)	H (in.)	L REF. (in.)	LL REF. (in.)	Pressure (x 1,000 PSI)	
						Static -S	Dynamic -S
4 P5ONBA	7/16-20 UN/UNF-2A	11/16	11/16	2.05	1.62	10.0	6.0
1/4 HPBA	1/4-18 NPTF	11/16	11/16	2.20	1.86	10.0	6.0

Dimensions and pressures for reference only, subject to change.



Parker Triple Thread (PTT) Adapters



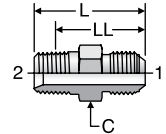
Parker Triple Thread (PTT) adapters are considered the original three-piece hydraulic flared fittings. As an improved fitting design over traditional two-piece flared fittings. Its use was widespread as a primary hydraulic connection for various aircraft, industrial and mobile applications. The PTT 30° flare three-piece design paved the progress towards the standardized 37° connection (through the Joint Industrial Council – JIC) and later to current standardization initiatives of SAE and ISO. Its popularity has been diminished by the more common and standardized 37° flare connection, but even today certain transportation customers utilize PTT hose adapters for OEM and MRO applications.

Applications:

- Diesel engine manufacturers
- Transportation air conditioning lines

0109

Parker Triple Thread Fitting
 NPTF / PTT



Mates with 32 style hose fittings.

TUBE FITTING PART #	END SIZE		C HEX (in.)	L (in.)	LL AFTER ASSY (in.)	Dynamic Pressure (x 1,000 PSI)		
	1 (in.)	2 NPTF				-S	-SS	-B
0109-12-16	1 (1 5/16-14)	3/4-14	1 3/8	1.84	1.36	3.0		
0109-16-16	1 (1 5/16-14)	1-11 1/2	1 3/8	2.03	1.46	3.0		
0109-20-20	1 1/4 (1 5/8-14)	1 1/4-11 1/2	1 3/4	2.22	1.63	3.0		
0109-24-24	1 1/2 (1 7/8-14)	1 1/2-11 1/2	2	2.50	1.91	3.0		



Dimensions and pressures for reference only, subject to change.

Screen Fittings

Introduction

Parker screen fittings ensure the final measure of protection against particles that find their way into a system (even a properly filtrated one) during installation, maintenance, failure of components or by other means. Screen fittings provide a vital safeguard for critical components against damage due to contamination. They are intended to work in conjunction with a good filtration system and are available with screens that retain particle sizes from 480 to 65 micron.

Parker screen fittings are ideal for protecting:

- Gauges and instrumentation
- Critical hydraulic components such as pump compensator load sensing controls, proportional valves, relief valves, etc.
- Precision orifices from clogging
- Expensive components in test bench circuits (against particle contamination created by failed components)

Design and Construction

Fitting Body. Parker screen fittings utilize standard Seal-Lok O-ring face seal and Triple-Lok 37° fitting bodies located in Section B and C respectively in this catalog. All screen fittings are manufactured with the micron rating stamped on the fitting body.

Screen. Screen fittings are constructed with stainless-steel screen elements. Sizes -6 through -12 fittings are manufactured with a dome-style screen, while size -4 fittings are made with a basket-style screen (see Fig. M7 and M8). Table M3 displays the various micron ratings for available screens. Additionally, Parker screen fittings have bi-directional flow capacity and can be installed in either the tube or port end of the fitting.

To prevent build up of debris, screens must be replaced or cleaned when filters are replaced or during flushing of hydraulic system.

Square Mesh Number	Nominal Micron Rating
40	480*
60	320*
80	230
100	165*
150	125
200	100
325	65

Table M3 — Micron Ratings for available screens

**These micron ratings are not available as standard from stock*

Pressure Ratings

Parker screen fittings have the same dynamic pressure ratings as the equivalent fitting body (without the screen). Refer to sections A and B for the pressure ratings for Seal-Lok O-ring face seal and Triple-Lok 37° flare fittings.



Fig. M6 — Screen Fittings.



Fig. M7 — Six dome-style screens and one basket-style screen.



Fig. M8 — Fitting cutaway with dome-style screen.

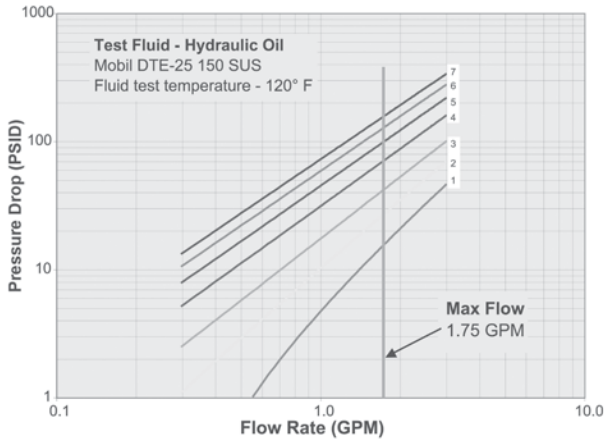
VISUAL INDEX

Dimensions and pressures for reference only, subject to change.

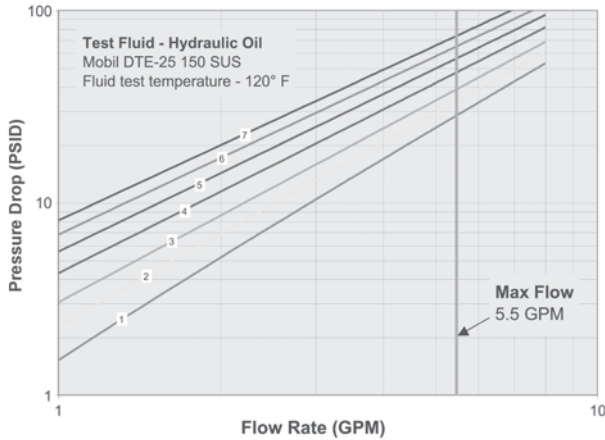
Pressure Drop

All screen fittings have been tested to determine the maximum pressure drop and screen retention. The following "Pressure Drop vs. Flow" charts were derived from actual test data and may be used as a guide in determining pressure drop at various flow rates through screen fittings for the fluid indicated.

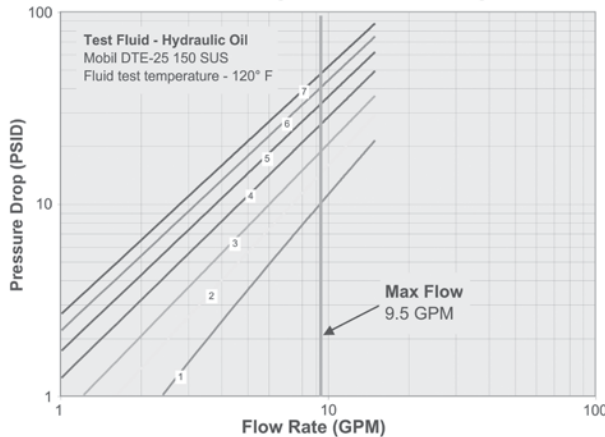
4 F50X Screen Adapter Pressure Drop vs. Flow



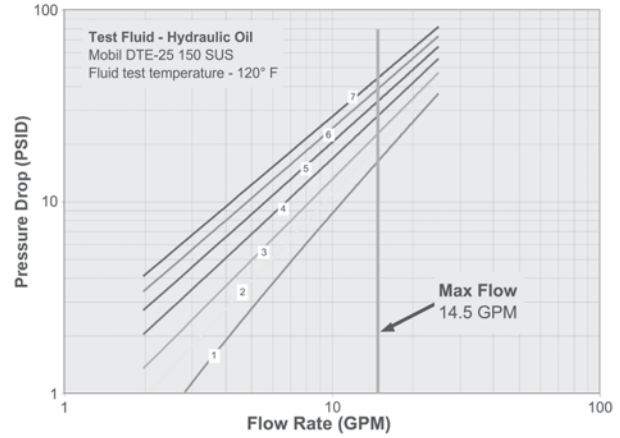
6 F50X Screen Adapter Pressure Drop vs. Flow



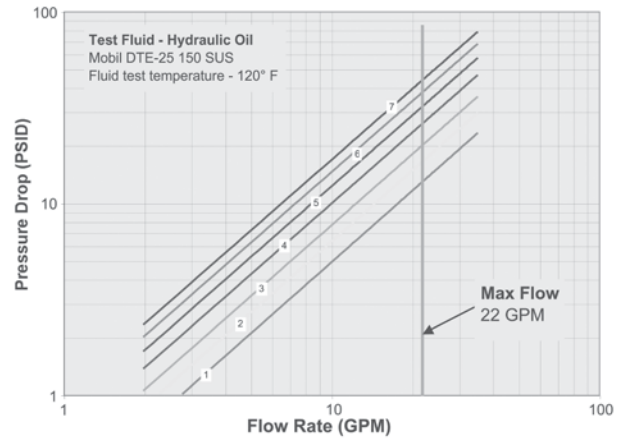
8 F50X Screen Adapter Pressure Drop vs. Flow



10 F50X Screen Adapter Pressure Drop vs. Flow



12 F50X Screen Adapter Pressure Drop vs. Flow



- 480MICRON (1)
- 320MICRON (2)
- 230MICRON (3)
- 165MICRON (4)
- 125MICRON (5)
- 100MICRON (6)
- 065MICRON (7)
- Max Flow

Refer to the General Technical Section for pressure drop data through standard fitting without screen.



Dimensions and pressures for reference only, subject to change.



**VISUAL
INDEX**

Dimensions and pressures for reference only, subject to change.



VISUAL
INDEX


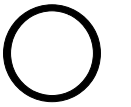
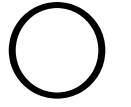

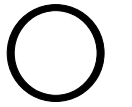
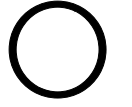
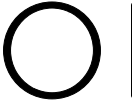
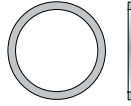
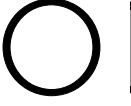
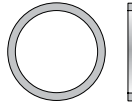

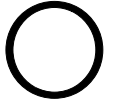




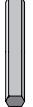




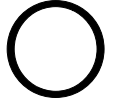

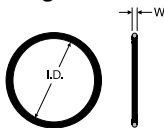
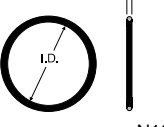


O-Rings and Seals

N



ENGINEERING YOUR SUCCESS.

 <p>O-Ring Face Seal</p>	<p>ORFS O-Ring</p>  <p>N4</p>	<p>XO O-Ring</p>  <p>N4</p>	 <p>Port Ends – SAE, Metric, BSPP, JIS, K4</p>	<p>SAE O-Ring</p>  <p>N4</p>	<p>ISO 6149 O-Ring</p>  <p>N5</p>
<p>Metric O-Ring</p>  <p>N5</p>	<p>Metric Retaining Ring</p>  <p>N5</p>	<p>BSPP O-Ring</p>  <p>N6</p>	<p>BSPP Retaining Ring</p>  <p>N6</p>	<p>EOlastic Seal Ring</p>  <p>N6</p>	<p>JIS B2351 O-Ring</p>  <p>N7</p>
<p>BSPP Bonded Seal</p>  <p>N7</p>	 <p>EO/EO-2</p>	<p>EO-2 Sealing Ring</p>  <p>N7</p>	<p>Bonded Seal for Banjo Fittings</p>  <p>N8</p>	<p>Metal Seal for Banjo Fittings</p>  <p>N8</p>	<p>Pressure Gauge Sealing Ring</p>  <p>N9</p>
<p>EO Swivel O-Ring</p>  <p>N9</p>	<p>EO O-Ring</p>  <p>N10</p>	 <p>4-Bolt Flanges</p>	<p>SAE 4-Bolt Flange O-Ring</p>  <p>N10</p>	 <p>Dual Seal Flanges</p>	<p>Radial Seal O-Ring</p>  <p>N10</p>
<p>Flange Seal O-Ring</p>  <p>N10</p>					

O-Ring Material Selection

Standard O-rings supplied with Parker tube fittings and adapters are 90 durometer hard nitrile (Buna-N). These O-rings are well suited for most industrial hydraulic and pneumatic systems. They have high extrusion resistance making them suitable for very high pressure static applications. Optional high temperature fluorocarbon, Parker compound #V0894, is also available for higher temperature specifications.

O-rings for other than normal hydraulic media or higher temperature applications can be selected from the following chart. The

chart should be used only as a general guide. Before making final selection for a given application, it is recommended that appropriate tests be conducted to assure compatibility with the fluid, temperature, pressure and other environmental conditions.

For fluids not shown in the chart, please contact the Tube Fittings Division.

VISUAL
INDEX

Polymer (Abbreviation)	Recommended for	Not Recommended for	Parker Compound No.	Color	SAE J515 Type	Hardness Shore "A"	Temperature Range (°F)	Comments
Nitrile-Butadiene (NBR)	Petroleum base oils and fluids, mineral oils, ethylene glycol base fluids, silicone and di-ester base lubricants, air, water under 150°F, and natural gas.	Phosphate ester base hydraulic fluids, automotive brake fluids, strong acids, ozone, freons, ketones, halogenated hydrocarbons, and methanol.	NBR	Black	CH ²⁾	90	-30° to 250° F	Standard from stock
			N0674	Black	—	70	-30° to 250° F	
			N0103	Black	—	70	-65° to 225° F	
			N1059	Black	CH ²⁾	90	-30° to 275° F	Low compression set
			N0507	Black	—	90	-65° to 180° F	Orange identification dot
			N0304	Black	—	75	-65° to 225° F	
N0508	Black	—	75	-35° to 250° F	Meets FDA requirements for food products			
			N0756	Black	—	75	-65° to 275° F	CNG applications. Standard from stock
Ethylene-Propylene (EPDM)	Phosphate ester base hydraulic fluids, hot water, steam to 400°F, silicone oils and greases, dilute acids and alkalis, ketones, alcohols and automotive brake fluids.	Petroleum base oils and di-ester base lubricants.	E0540	Black	CA ³⁾	80	-65° to 275° F	CO2 climate control systems. H2 fuel cells.
			E0893	Purple ¹⁾	CA ³⁾	80	-65° to 275° F	
			E0962	Black	—	90	-65° to 275° F	
Neoprene (CR)	Refrigerants (freons, ammonia), high aniline point petroleum oils, mild acids, and silicate ester lubricants.	Phosphate ester fluids and ketones.	C0873	Black	—	70	-45° to 250° F	
			C0944	Red ¹⁾	—	70	-45° to 250° F	
Fluorocarbon (FKM ⁵⁾ or FPM)	Petroleum base oils and fluids, some phosphate ester base fluids, silicone and silicate ester base lubricants, di-ester base lubricants, acids and halogenated hydrocarbons.	Ketones, skydrol fluids, amines (VDMH), anhydrous ammonia, low molecular weight esters and ethers, and hot hydrofluoric or chlorosulfonic acids.	V0747	Black	—	75	-15° to 400° F	Standard from stock.
			V0884	Brown ¹⁾	—	75	-15° to 400° F	
			V0894	Brown ¹⁾	HK ⁴⁾	90	-15° to 400° F	
Silicone (Si)	Dry heat (air to 400°F) and high aniline point oils.	Most petroleum fluids, ketones, water and steam.	S0604	Rust ¹⁾	—	70	-65° to 450° F	

N

Table U6 — O-Ring Selection

- 1) These Parker "Chromasure" color assurance O-rings are available from the Parker Hannifin O-Ring Division. They help eliminate assembly errors, reduce warranty costs and liability risks, and assure safety in aftermarket business.
- 2) Formerly SAE Type I.
- 3) Formerly SAE Type II.
- 4) Formerly SAE Type III.
- 5) "FKM" is the ASTM designation for fluorocarbon. Its ISO designation is "FPM".

Note: Use 90 durometer hard O-rings for applications with 1500 psi or higher pressures.

Dimensions for reference only, subject to change.

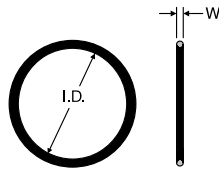


ORFS O-Ring

ORFS Tube End O-Ring

Specify size and compound

Example: 2-018 NBR (standard NBR)



XO O-Ring

Triple-Lok 2 O-Ring

Specify size and compound

Example: 2-019 NBR (standard NBR)

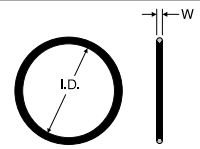


TABLE OF CONTENTS

VISUAL INDEX

TUBE FITTING PART #	FITTING DASH SIZE	END SIZE		I.D.		W		Material		
		(in.)	(mm)	(in.)	(mm)	(in.)	(mm)	NBR*	FKM**	N0756***
2-011	4	1/4	6	0.30	7.7	0.07	1.78	•	•	•
2-012	6	3/8	8, 10	0.36	9.3	0.07	1.78	•	•	•
2-014	8	1/2	12	0.49	12.4	0.07	1.78	•	•	•
2-016	10	5/8	14, 15, 16	0.61	15.6	0.07	1.78	•	•	•
2-018	12	3/4	18, 20	0.74	18.8	0.07	1.78	•	•	•
2-020	14	7/8	22	0.86	21.8	0.07	1.78	•	•	•
2-021	16	1	25	0.93	23.5	0.07	1.78	•	•	•
2-025	20	1 1/4	28, 30, 32	1.18	29.9	0.07	1.78	•	•	•
2-029	24	1 1/2	35, 38	1.49	37.8	0.07	1.78	•	•	•
2-135	32	2	50	1.93	49.0	0.10	2.54	•	•	•

TUBE FITTING PART #	TUBE O.D. (in.)	I.D. (in.)	W (in.)	Material
				NBR
5-193	1/4	0.18	0.04	•
5-179	5/16	0.24	0.04	•
5-056	3/8	0.30	0.04	•
5-058	1/2	0.43	0.05	•
2-013	5/8	0.43	0.07	•
2-016	3/4	0.61	0.07	•
2-017	7/8	0.68	0.07	•
2-019	1	0.80	0.07	•
2-023	1 1/4	1.05	0.07	•
2-026	1 1/2	1.24	0.07	•
2-133	2	1.80	0.10	•

* NBR is the standard compound — 90-durometer Nitrile.

** FKM is an optional 90-durometer fluorocarbon compound.

*** N0756 is an optional 75-durometer Nitrile compound for CNG applications.

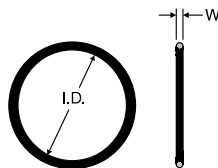
See page N3 for O-ring Material Selection and data.

SAE O-Ring

SAE Straight Thread Port O-Ring

Specify size and compound

Example: 3-906 NBR (standard NBR)



TUBE FITTING PART #	FITTING DASH SIZE	I.D. (in.)	W (in.)	Material		
				NBR*	FKM**	N0756***
3-902	2	0.24	0.06	•	•	
3-903	3	0.30	0.06	•	•	
3-904	4	0.35	0.07	•	•	•
3-905	5	0.41	0.07	•	•	
3-906	6	0.47	0.08	•	•	•
3-908	8	0.64	0.09	•	•	•
3-910	10	0.76	0.10	•	•	
3-912	12	0.92	0.12	•	•	
3-914	14	1.05	0.12	•	•	
3-916	16	1.17	0.12	•	•	
3-920	20	1.48	0.12	•	•	
3-924	24	1.72	0.12	•	•	
3-932	32	2.34	0.12	•	•	

* NBR is the standard compound — 90-durometer Nitrile.

** FKM is an optional 90-durometer fluorocarbon compound.

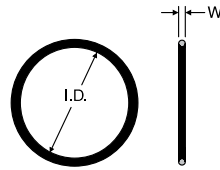
*** N0756 is an optional 75-durometer Nitrile compound for CNG applications.

See page N3 for O-ring Material Selection and data.

Dimensions for reference only, subject to change.

ISO 6149 O-Ring

Metric Straight Thread
Port O-Ring



Specify size and compound (for option compound only)
Example: M-12 ISO O-RING (standard NBR)
M-12 ISO VITON O-RING (optional FKM)

TABLE
OF
CONTENTS

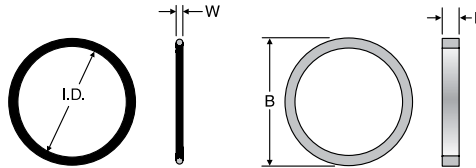
VISUAL
INDEX

TUBE FITTING PART #	PORT THREAD	I.D. (mm)	W (mm)	Material	
				NBR**	FKM***
M-8 ISO O-Ring	M8 x 1	6.1	1.6	•	
M-10 ISO O-Ring	M10 x 1	8.1	1.6	•	
M-12 ISO O-Ring	M12 x 1.5	9.3	2.2	•	•
M-14 ISO O-Ring	M14 x 1.5	11.3	2.2	•	•
M-16 ISO O-Ring	M16 x 1.5	13.3	2.2	•	•
M-18 ISO O-Ring	M18 x 1.5	15.3	2.2	•	•
M-22 ISO O-Ring	M22 x 1.5	19.3	2.2	•	•
M-27 ISO O-Ring	M27 x 2	23.6	2.9	•	•
*M-30 ISO O-Ring	M30 x 2	26.6	2.9	•	
M-33 ISO O-Ring	M33 x 2	29.6	2.9	•	•
M-38 ISO O-Ring	M38 x 2	34.6	2.9	•	
M-42 ISO O-Ring	M42 x 2	38.6	2.9	•	•
M-48 ISO O-Ring	M48 x 2	44.6	2.9	•	•
M-60 ISO O-Ring	M60 x 2	56.6	2.9	•	

* M30X2 is not a standard ISO 6149 size.
** NBR is the standard compound — 90-durometer peroxide-cured Nitrile.
*** FKM is an optional 90-durometer fluorocarbon compound (for part number, VITON is used eg. M-8 ISO VITON O-RING).
See page N3 for O-ring Material Selection and data.

Metric O-Ring & Retaining Ring

For ISO 9974-1 / DIN 3852-1Port



Specify size and compound
Example: 2-012 NBR (standard NBR O-ring)
M12RRCF (standard steel retaining ring)

N

TUBE FITTING PART #	METRIC THREAD SIZE	I.D. (mm)	W (mm)	From Stock		TUBE FITTING PART #	B (mm)	L (mm)	Material	
				NBR*	FKM**				CF	71
3-902	M8 x 1	6.07	1.63	•	•	M8RR	13.15	1.00	•	
6-074	M10 x 1	8.00	1.50	•	•	M10RR	14.75	1.00	•	
2-012	M12 x 1.5	9.25	1.78	•	•	M12RR	17.75	1.30	•	
2-013	M14 x 1.5	10.82	1.78	•	•	M14RR	19.75	1.30	•	
3-907	M16 x 1.5	13.46	2.08	•	•	M16RR	21.75	1.50	•	
2-114	M18 x 1.5	15.54	2.62	•	•	M18RR	23.75	2.00	•	
2-017	M20 x 1.5	17.17	1.78	•		M20RR	25.75	1.30	•	
2-018	M22 x 1.5	18.77	1.78	•	•	M22RR	27.75	1.30	•	
2-019	M24 x 1.5	20.35	1.78	•		M24RR	29.75	1.30	•	
2-118	M26 x 1.5	21.89	2.62	•		M26RR	31.75	2.00	•	
2-119	M27 x 2	23.47	2.62	•	•	M27RR	32.75	2.00	•	
2-121	M30 x 2	26.64	2.62	•		M30RR	36.32	2.00	•	
2-122	M33 x 2	28.24	2.62	•		M33RR	39.75	2.00	•	
2-124	M36 x 2	31.42	2.62	•		M36RR	42.75	2.00	•	
2-128	M42 x 2	37.77	2.62	•		M42RR	49.75	2.00	•	
2-130	M45 x 2	40.94	2.62	•		M45RR	52.75	2.00	•	
2-132	M48 x 2	44.12	2.62	•		M48RR	54.95	2.00	•	
2-133	M50 x 2	45.69	2.62	•		M50RR	56.31	2.00	•	

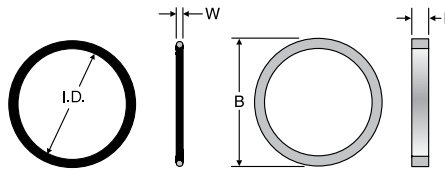
* NBR is the standard compound — 90-durometer Nitrile.
** FKM is an optional 90-durometer fluorocarbon compound.
See page N3 for O-ring Material Selection and data.

Dimensions for reference only, subject to change.



BSPP O-Ring & Retaining Ring

For ISO 1179-1 / DIN 3852-2 Port



Specify size and compound (for O-ring only)
 Example: 2-113 NBR (standard NBR O-ring)
 3/8 RETAINING RING (standard steel retaining ring)

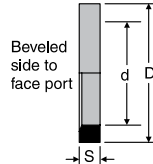


TUBE FITTING PART #	BSPP THREAD SIZE	I.D. (mm)	W (mm)	Material		TUBE FITTING PART #	B (mm)	L (mm)	Material	
				NBR*	FKM**				S	SS
OR8X2X	1/8-28	8	2	•	•	1/8 Retaining Ring	15.0	1.4	•	
2-111	1/4-19	10.77	2.62	•	•	1/4 Retaining Ring	19.5	1.9	•	
2-113	3/8-19	13.94	2.62	•	•	3/8 Retaining Ring	23.5	1.9	•	
5-256	1/2-14	17.96	2.62	•	•	1/2 Retaining Ring	28.5	1.9	•	
2-119	3/4-14	23.47	2.62	•	•	3/4 Retaining Ring	34.5	2.6	•	
2-217	1-11	29.74	3.53	•	•	1 Retaining Ring	43.5	2.6	•	
2-222	1 1/4-11	37.69	3.53	•		1 1/4 Retaining Ring	52.5	2.6	•	
2-224	1 1/2-11	44.04	3.53	•		1 1/2 Retaining Ring	60.0	2.6	•	
2-227	2-11	53.57	3.53			2 Retaining Ring	75.0	2.6		

* NBR is the standard compound — 90-durometer Nitrile.
 ** FKM is an optional 90-durometer fluorocarbon compound.
 See page N3 for O-ring Material Selection and data.

EOlastic Seal Ring

EOlastic Soft Seal for
BSPP & Metric Threads (“ED Seal”)
DIN 3869



Specify size and compound
 (for optional compound only)
 Example: ED8X1X (standard NBR)
 ED8X1VITX (optional FPM)

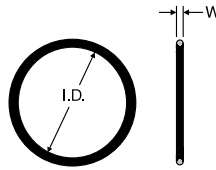
TUBE FITTING PART #	For Male Metric Thread	For Male Thread BSPP	D (mm)	d (mm)	S (mm)	Material	
						NBR*	FKM**
ED8X1X	M8 x 1		9.9	6.5	1.0	•	•
ED10X1X	M10 x 1	G 1/8 A	11.9	8.4	1.0	•	•
ED12X1.5X	M12 x 1.5		14.4	9.8	1.5	•	•
ED14X1.5X	M14 x 1.5	G 1/4 A	16.5	11.6	1.5	•	•
ED16X1.5X	M16 x 1.5		18.9	13.8	1.5	•	•
ED3/8X		G 3/8 A	18.9	14.7	1.5	•	•
ED18X1.5X	M18 x 1.5		20.9	15.7	1.5	•	•
ED20X1.5X	M20 x 1.5		22.9	17.8	1.5	•	•
ED1/2X		G 1/2 A	23.9	18.5	1.5	•	•
ED22X1.5X	M22 x 1.5		24.3	19.6	1.5	•	•
ED26X1.5X	M26 x 1.5	G 3/4 A	29.2	23.9	1.5	•	•
ED26X1.5X	M27 x 2	G 3/4 A	29.2	23.9	1.5	•	•
ED33X2X	M33 x 2	G 1 A	35.7	29.7	2.0	•	•
ED42X2X	M42 x 2	G 1 1/4 A	45.8	38.8	2.0	•	•
ED48X2X	M48 x 2	G 1 1/2 A	50.7	44.7	2.0	•	•

* NBR is the standard compound — 90-durometer Nitrile.
 ** FKM is an optional 85-durometer fluorocarbon compound (for part number VIT is used as suffix). Example: ED8X1VITX

Dimensions for reference only, subject to change.



JIS B2351 O-Ring



TUBE FITTING PART #	JIS DASH SIZE	T4 THREAD BSPP	I.D. (mm)	W (mm)	JIS B 2401 Description
P8 O-RING	2	1/8-28	7.8	1.9	O-RING CLASS 1 B P 8
P11 O-RING	4	1/4-19	10.8	2.4	O-RING CLASS 1 B P 11
P14 O-RING	6	3/8-19	13.8	2.4	O-RING CLASS 1 B P 14
P18 O-RING	8	1/2-14	17.8	2.4	O-RING CLASS 1 B P 18
P24 O-RING	12	3/4-14	23.7	3.5	O-RING CLASS 1 B P 24
P29 O-RING	16	1-11	28.7	3.5	O-RING CLASS 1 B P 29

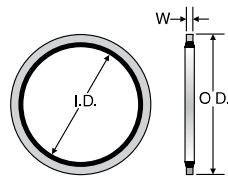
* NBR is the standard compound — 90-durometer Nitrile.

TABLE OF CONTENTS

VISUAL INDEX

BSPP Bonded Seal

Used on K4 Style Straight Fittings as a Port Seal
For use with ISO 1179 / DIN 3852-2 port



TUBE FITTING PART #	BSPP THREAD SIZE	O.D. (mm)	I.D. (mm)	W (mm)	Material		
					S*	SS	B
D9DT-2	1/8-28	15.9	10.4	2.0	•		
D9DT-4	1/4-19	20.6	13.7	2.0	•		
D9DT-6	3/8-19	23.8	17.3	2.0	•		
D9DT-8	1/2-14	28.6	21.5	2.3	•		
D9DT-10	5/8-14	31.8	23.5	2.3	•		
D9DT-12	3/4-14	34.9	27.1	2.3	•		
D9DT-16	1-11	42.8	33.9	2.3	•		
D9DT-20	1 1/4-11	52.4	42.9	3.3	•		
D9DT-24	1 1/2-11	58.6	48.4	3.3	•		

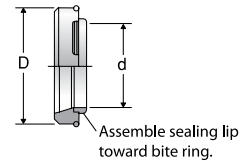
* NBR is the standard elastomer compound — 90-durometer Nitrile
Zinc plated steel ring

EO-2 Sealing Ring

Specify size and material

Examples:

- DOZ10S (standard steel with NBR)
- DOZ10SVIT (standard steel with FKM)
- DOZ10S71 (standard stainless steel with FKM)



TUBE FITTING PART #	SERIES	TUBE O.D. (mm)	D (mm)	d (mm)	Material		
					S	SS	B
DOZ04LL	LL	4	6.8	4	•		
DOZ06LL	very light	6	8.8	6	•		
DOZ06L	L	6	10.3	6	•	•	•
DOZ08L	light	8	12.3	8	•	•	•
DOZ10L		10	14.3	10	•	•	•
DOZ12L		12	16.3	12	•	•	•
DOZ15L		15	20.3	15	•	•	•
DOZ18L		18	24.3	18	•	•	•
DOZ22L		22	27.7	22	•	•	•
DOZ28L		28	33.7	28	•	•	•
DOZ35L		35	42.7	35	•	•	•
DOZ42L		42	49.7	42	•	•	•
DOZ06S	S	6	12.3	6	•	•	•
DOZ08S	heavy	8	14.3	8	•	•	•
DOZ10S		10	16.3	10	•	•	•
DOZ12S		12	18.3	12	•	•	•
DOZ14S		14	20.3	14	•	•	•
DOZ16S		16	22.3	16	•	•	•
DOZ20S		20	27.7	20	•	•	•
DOZ25S		25	33.7	25	•	•	•
DOZ30S		30	39.7	30	•	•	•
DOZ38S		38	49.7	38	•	•	•

* Steel black zinc plated with NBR 90-durometer Nitrile compound.

** Steel black zinc plated with FKM 90-durometer fluorocarbon compound.

*** Stainless steel with FKM 90-durometer fluorocarbon compound.

Dimensions for reference only, subject to change.

Bonded Seal for Banjo Fittings

Specify size and material

- Examples: KDS 12X (standard steel with NBR)
- KDS 12VITX (standard steel with FKM)
- KDS 1271 (standard stainless steel with PTFE)

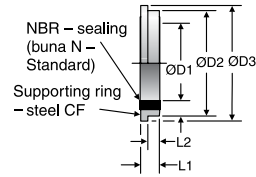


TABLE
OF
CONTENTS

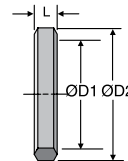
VISUAL
INDEX

TUBE FITTING PART #	FOR USE WITH WH & TH BANJOS	THREAD	D1 (mm)	D2 (mm)	D3 (mm)	L1 (mm)	L2 (mm)	Material	
								CF	71
KDS10	6-LM/LR	M10 x 1/G1/8A	10.3	14.9	16.0	2.5	1.1	•	
KDS12	6-SM/8-LM	M12 x 1.5	12.3	17.0	18.0	3.0	1.6	•	
KDS14	6-SR, 8-LR/SM/SR, 10-LM/LR	M14 x 1.5/G1/4A	14.3	18.9	20.0	3.0	1.6	•	
KDS16	10-SM/SR, 12-LM/LR/SR	M16 x 1.5/G3/8A	17	21.9	24.0	3.0	2.1	•	
KDS18	12-SM/15-LM	M18 x 1.5	18.3	23.9	23.9	3.0	—	•	
KDS22	15-LR, 16-SM/SR, 18-LM/LR	M22 x 1.5/G1/2A	22.3	26.9	30.0	4.5	2.6	•	
KDS26	22-LM	M26 x 1.5	26.3	31.9	35.0	3.5	2.6	•	
KDS27	20-SM/SR, 22-LR	M27 x 2/G3/4A	27.3	32.9	38.0	3.5	2.6	•	
KDS33	25-SM/SR, 28-LM/LR	M33 x 2/G1A	33.6	39.9	42.0	3.5	2.6	•	
KDS42	30-SM/SR, 35-LM/LR	M42 x 2/G1 1/4A	42.4	49.9	49.9	3.5	—	•	
KDS48	38-SM/SR, 42-LM/LR	M48 x 2/G1 1/2A	48.4	55.9	60.0	3.5	2.6	•	

Metal Seal for Banjo Fittings

Specify size and material

- Examples: DKA1/8CFX (steel)
- DKA1/871X (stainless steel)

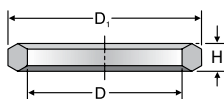


TUBE FITTING PART #	FOR APPLICATION IN BANJOS:				THREAD	D1 (mm)	D2 (mm)	L (mm)	Material	
	WH / TH		SWVE						CFX	71X
BSP										
DKA1/8	6LR		4/6/8 LLR	6LR	G 1/8 A	9.8	14	2.5	•	•
DKA1/4	8LR	6SR	8LR	6SR	G 1/4 A	13.3	18	3.0	•	•
DKA1/4	10LR	8SR	10LR	8SR	G 1/4 A	13.3	18	3.0	•	•
DKA3/8	12LR	10SR	12LR	10SR	G 3/8 A	16.8	22	3.0	•	•
DKA3/8		12SR		12SR	G 3/8 A	16.8	22	3.0	•	•
DKA1/2			15/18LR	14/16SR	G 1/2 A	21.1	26	3.0	•	•
DKA1/2X4.5	15LR	14SR			G 1/2 A	21.1	26	4.5	•	•
DKA1/2X4.5	18LR	16SR			G 1/2 A	21.1	26	4.5	•	•
DKA3/4	22LR	20SR	22LR	20SR	G 3/4 A	26.6	32	3.5	•	•
DKA1	28LR	25SR			G 1 A	33.4	39	3.5	•	•
DKA11/4	35LR	30SR			G 1 1/4 A	42.1	49	3.5	•	•
DKA11/2	42LR	38SR			G 1 1/2 A	48.1	55	3.5	•	•
Metric										
DKA10	6LM		6/8LLM	6LM	M10 x 1	10.1	14	2.5	•	•
DKA12	8LM	6SM	8LM	6SM	M12 x 1.5	12.1	17	3.0	•	•
DKA14	10LM	8SM	10LM	8SM	M14 x 1.5	14.1	19	3.0	•	•
DKA16	12LM	10SM	12LM	10SM	M16 x 1.5	16.1	21	3.0	•	•
DKA18	15LM	12SM	15LM	12SM	M18 x 1.5	18.1	23	3.0	•	•
DKA20		14SM		14SM	M20 x 1.5	20.1	25	3.0	•	•
DKA22			18LM	16SM	M22 x 1.5	22.1	27	3.0	•	•
DKA22X4.5	18LM	16SM			M22 x 1.5	22.1	27	4.5	•	•
DKA26			22LM		M26 x 1.5	26.1	31	3.0	•	•
DKA26X3.5	22LM				M26 x 1.5	26.1	31	3.5	•	•
DKA27		20SM		20SM	M27 x 2	27.1	32	3.5	•	•
DKA33	28LM	25SM			M33 x 2	33.1	39	3.5	•	•
DKA11/4	35LM	30SM			M42 x 2	42.1	49	3.5	•	•
DKA11/2	42LM	38SM			M48 x 2	48.1	55	3.5	•	•

Dimensions for reference only, subject to change.



Pressure Gauge Sealing Ring



Specify size and material

Examples: DK11/2CFX (steel)
DK11/271X (stainless steel)

TUBE FITTING PART #	FOR INTERNAL BSPP THREAD	D (mm)	D1 (mm)	H (mm)	Material		
					CFX	71	COPPER
DK11/4	G 1/4 - 19	6.0	11.3	4.5	•		
DK11/2	G 1/2 - 19	12.0	18.5	5.0	•	•	
M25180	G 1/4	6.4	11.0	1.6			•

EO Swivel O-Ring

O-ring for EO Swivel Nuts, Weld Nipples, and Caps

Part Numbers: RED, DA, GZ, GZR, EGE, EGEO, SKA, EW, ET, EL, VKA, MAVÉ

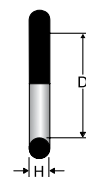


TABLE OF CONTENTS

VISUAL INDEX

EO SIZE/SERIES	O-RING NBR*	D	H	O-RING FKM ²	D	H
6L	OR4.5X1.5X	4.5	1.5	OR4.5X1.5VITX	4.5	1.5
8L	OR6.5X1.5X	6.5	1.5	OR6.5X1.5VITX	6.5	1.5
10L	OR8.5X1.5X	8.5	1.5	OR8X1.5VITX	8.0	1.5
12L	OR10.5X1.5X	10.5	1.5	OR10X1.5VITX	10.0	1.5
15L	OR12.5X2X	12.5	2.0	OR12X2VITX	12.0	2.0
18L	OR16X2X	16.0	2.0	OR15X2VITX	15.0	2.0
22L	OR20X2X	20.0	2.0	OR20X2VITX	20.0	2.0
28L	OR26X2X	26.0	2.0	OR26X2VITX	26.0	2.0
35L	OR32X2.5X	32.0	2.5	OR32X2.5VITX	32.0	2.5
42L	OR39X2.5X	39.0	2.5	OR38X2.5VITX	38.0	2.5
6S	OR4.5X1.5X	4.5	1.5	OR4.5X1.5VITX	4.5	1.5
8S	OR6.5X1.5X	6.5	1.5	OR6.5X1.5VITX	6.5	1.5
10S	OR8.5X1.5X	8.5	1.5	OR8X1.5VITX	8.0	1.5
12S	OR10.5X1.5X	10.5	1.5	OR10X1.5VITX	10.0	1.5
14S	OR12X2X	12.0	2.0	OR12X2VITX	12.0	2.0
16S	OR14X2X	14.0	2.0	OR13X2VITX	13.0	2.0
20S	OR17X2.5X	17.0	2.5	OR16.3X2.4VITX	16.3	2.4
25S	OR22X2.5X	22.0	2.5	OR20.3X2.4VITX	20.3	2.4
30S	OR27X2.5X	27.0	2.5	OR25.3X2.4VITX	25.3	2.4
38S	OR35X2.5X	35.0	2.5	OR33.3X2.4VITX	33.3	2.4

*NBR is standard compound — 90-durometer Nitrile.

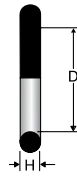
²FKM is optional 85-durometer Fluorocarbon compound.

N

Dimensions for reference only, subject to change.

EO O-Ring

O-ring for EO Banjo Fitting Bolts
Part Numbers: WH/TH



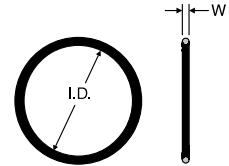
BANJO BOLT METRIC THREAD	BANJO BOLT BSPP THREAD	D	H	O-RING NBR*	O-RING FKM**
M10	G 1/8	9.3	1.5	OR9.3X1.5X	OR9.3X1.5VITX
M12, M14	G 1/4	12.5	1.5	OR12.5X1.5X	OR12.5X1.5VITX
M16	G 3/8	16.0	1.5	OR16X1.5X	OR16X1.5VITX
M18		18.0	1.5	OR18X1.5X	OR18X1.5VITX
M20, M22	G 1/2	20.0	1.5	OR20X1.5X	OR20X1.5VITX
M26, M27	G 3/4	25.0	2.0	OR25X2X	OR25X2VITX
M33	G 1	33.0	2.5	OR33X2.5X	OR33X2.5VITX
M42	G 1 1/4	41.0	2.5	OR41X2.5X	OR41X2.5VITX
M48	G 1 1/2	46.0	3.0	OR46X3X	OR46X3VITX

*NBR is standard compound — 90-durometer Nitrile.

**FKM is optional 85-durometer Fluorocarbon compound.

SAE 4-Bolt Flange O-Ring

Code 61 and Code 62 Flanges



Specify size and compound
Example: 2-210 NBR

TUBE FITTING PART #	HOSE PRODUCTS DIVISION PART # ⁽¹⁾	FITTING DASH SIZE	W (in.)	I.D. (in.)	Material NBR*
2-210	711510-6	8	0.139	0.734	•
2-214	711510-5	12	0.139	0.984	•
2-219	711510-4	16	0.139	1.296	•
2-222	711510-3	20	0.139	1.484	•
2-225	711510-2	24	0.139	1.859	•
2-228	711510-1	32	0.139	2.234	•
2-232	711510-7	40	0.139	2.734	•
2-237	711510-8	48	0.139	3.359	•
2-241		56	0.139	3.859	•
2-245		64	0.139	4.359	•
2-253		80	0.139	5.359	•

*NBR is the standard compound — 90-durometer Nitrile.

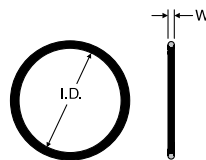
O-ring for DIN 2353 EO Gear Pump Flange Adapters
Part Numbers: BFG/BFW

FLANGE SERIES "LK"	D	H	O-RING NBR*
LK35	20.0	2.5	OR20X2.5X
LK40	26.0	2.5	OR26X2.5X
LK55	33.0	2.5	OR33X2.5X

*NBR is standard compound — 90-durometer Nitrile.

Radial Seal O-Ring

Dual Seal Port O-Ring

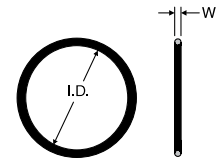


TUBE FITTING PART #	END SIZE	W (in.)	I.D. (in.)
	2 DUAL SEAL		
2-113	1/2	0.103	0.549
2-123	1	0.103	1.174
2-129	1 1/2	0.103	1.549

Standard O-ring compound - 90 durometer NBR. Ordering example with material: 2-113 NBR.

Flange Seal O-Ring

Dual Seal Flange Head O-Ring



TUBE FITTING PART #	END SIZE	W (in.)	I.D. (in.)
	2 DUAL SEAL		
2-022	1/2	0.070	0.989
2-129	1	0.103	1.549
2-136	1 1/2	0.103	1.987

Standard O-ring compound - 90 durometer NBR.

TABLE OF CONTENTS

VISUAL INDEX



ParKlamp Inch Tube Clamps

0

**TABLE
 OF
 CONTENTS**


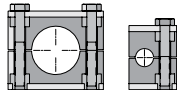





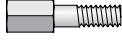
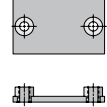
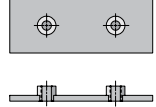


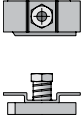

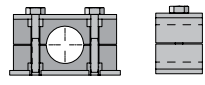



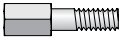
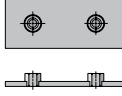

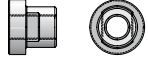
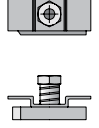

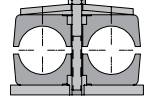

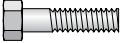

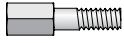
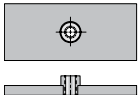

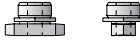
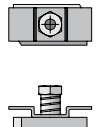

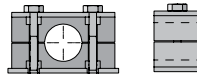



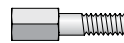
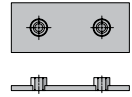
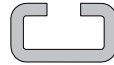

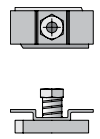

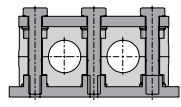
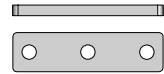
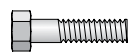
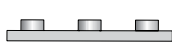
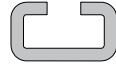

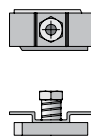
 <p>Standard Series</p>	<p>Clamp Halves</p>  <p>O7</p>	<p>CP Cover Plate</p>  <p>O8</p>	<p>BCP Hexagon Head Bolt for Cover Plate</p>  <p>O8</p>	<p>IPS Insert</p>  <p>O8</p>	<p>BIP Hexagon Head Bolt for Insert</p>  <p>O8</p>
<p>LP Locking Plate</p>  <p>O8</p>	<p>SB Stacking Bolt</p>  <p>O8</p>	<p>WP Weld Plate</p>  <p>O9</p>	<p>WPE Weld Plate Elongated</p>  <p>O9</p>	<p>R Mounting Rail</p>  <p>O9</p>	<p>HRN Hexagon Rail Nut</p>  <p>O9</p>
<p>CRA Channel Rail Adapter</p>  <p>O9</p>	 <p>Heavy Series</p>	<p>Clamp Halves Heavy</p>  <p>O10</p>	<p>CPH Cover Plate Heavy</p>  <p>O11</p>	<p>BCPH Hexagon Head Bolt for Cover Plate</p>  <p>O11</p>	<p>LPH Locking Plate Heavy</p>  <p>O11</p>
<p>SBH Stacking Bolt Heavy</p>  <p>O11</p>	<p>WPH Weld Plate Heavy</p>  <p>O11</p>	<p>RH Mounting Rail Heavy</p>  <p>O12</p>	<p>RNH Mounting Rail Nut Heavy</p>  <p>O12</p>	<p>CRA Channel Rail Adapter</p>  <p>O12</p>	
 <p>Twin Series</p>	<p>Clamp Halves</p>  <p>O13</p>	<p>CPT Cover Plate</p>  <p>O14</p>	<p>BCPT Hexagon Head Bolt for Cover Plate</p>  <p>O14</p>	<p>LPT Locking Plate</p>  <p>O14</p>	<p>SBT Stacking Bolt</p>  <p>O14</p>
<p>WPT Weld Plate Twin</p>  <p>O15</p>	<p>R Mounting Rail</p>  <p>O15</p>	<p>RNT Mounting Rail Nut Twin</p>  <p>O15</p>	<p>CRA Channel Rail Adapter</p>  <p>O15</p>		

TABLE
 OF
 CONTENTS

 <p>Compact Spiral Hose Heavy Series</p>	<p>Clamp Halves Heavy</p>  <p>O16</p>	<p>CPH Cover Plate Heavy</p>  <p>O17</p>	<p>BCPH Hexagon Head Bolt for Cover Plate</p>  <p>O17</p>	<p>LPH Locking Plate Heavy</p>  <p>O17</p>	<p>SBH Stacking Bolt Heavy</p>  <p>O17</p>
<p>WPH Weld Plate Heavy</p>  <p>O17</p>	<p>RH Mounting Rail Heavy</p>  <p>O18</p>	<p>RNH Mounting Rail Nut Heavy</p>  <p>O18</p>	<p>CRA Channel Rail Adatper</p>  <p>O18</p>	 <p>Compact Spiral Hose Heavy Twin</p>	<p>Clamp Halves Heavy Twin</p>  <p>O19</p>
<p>CPHT Cover Plate</p>  <p>O20</p>	<p>BCPH Hexagon Head Bolt for Cover Plate</p>  <p>O20</p>	<p>WPHT Weld Plate</p>  <p>O20</p>	<p>RH Mounting Rail Heavy</p>  <p>O20</p>	<p>RNH Mounting Rail Nut Heavy</p>  <p>O20</p>	<p>CRA Channel Rail Adatper</p>  <p>O20</p>

O

Dimensions and pressures for reference only, subject to change.

Introduction

The ParKlump system is designed for restraining tube, pipe and hose assemblies against unwanted and potentially harmful effects of mechanical shock and vibration forces that are common in fluid power systems.

The clamping system is the most commonly overlooked aspect of fluid power system design. Failure to properly restrain the fluid conductors can result in leakage, downtime and system malfunction, as well as significantly reduce the life of tube, pipe and hose assemblies. With the ParKlump system, the risk of problems resulting from mechanical shock and vibration can be significantly reduced.

Design and Construction

Designed to meet the basic envelope dimensions of DIN 3015, Part 1, the ParKlump plastic clamp halves are interchangeable with the Parker metric clamp system. The primary difference between these two clamping systems is the utilization of inch, as opposed to metric, thread hardware in the ParKlump system. All plastic clamp halves in the ParKlump system are manufactured from Polypropylene material. The hardware portion of the ParKlump system is available in plated steel and stainless steel.

For convenience, the ParKlump system is divided into three different series: Standard, Heavy and Twin. Each series has corresponding components, physical dimensions and mechanical properties. Within each series, there are a number of groups, each with specific envelope dimensions. Components from different series and/or groups can not be intermixed. However, the standard and twin series can be mounting on the same mounting rail.

How It Works

The ParKlump system has two primary methods for mounting: weld plates and mounting rails.

Clamps should be mounted to a rigid structure for optimum performance. Clamping tube, pipe or hose assemblies together without mounting them to a rigid structure, often called “floating clamps,” does not provide adequate support.

Proper design of a clamping system requires that the clamps be positioned appropriately on the tube, pipe or hose assemblies. See the Assembly and Installation section of this catalog for more information on clamp location and spacing.

Weld Plate Mounting (Fig. O1)

The weld plate mounting system allows the user to attach a single clamp assembly to a structure of similar material (steel to steel, etc) by welding the components together. Once the weld plate is attached to a structure, one clamp half can be placed onto the weld plate, followed by the tube, pipe or hose assembly. Next, the second plastic clamp half can be placed on the tube, pipe or hose assembly, followed by the cover plate (or Insert). To complete the assembly, the Hex Head attachment bolts are inserted into the assembly and tightened to the torque shown in the Assembly section of this catalog.



Fig. O1 – Weld Plate Assembly

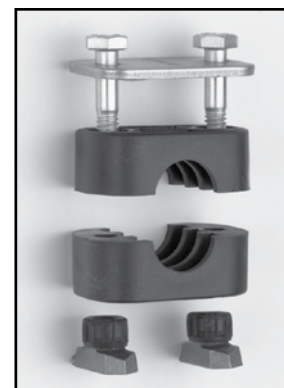


Fig. O2 – Mounting Rail Assembly

TABLE OF CONTENTS

VISUAL INDEX

Assembly and Installation

Please refer to Section S for the assembly and installation instructions for ParKlump Inch Tube Clamps.

Mounting Rail Mounting (Fig. O2)

Use of a mounting rail is another way to assemble the clamping system components onto a support structure. Using a mounting rail allows multiple clamps to be mounted side-by-side for restraining a group of tube, pipe, or hose assemblies. The mounting rail also provides the ability to move the location of the clamps in one direction for easier alignment. The rail can be attached to a support structure by welding or bolting. Once the mounting rail is in place, rail nuts can be slid into the rail. The first clamp half, followed by the tube, pipe or hose assembly, can then be installed over the corresponding rail nuts. After this, the second clamp half, the cover plate (or Insert) and the hex head attachment bolts can be installed to complete the assembly.

Stacking (Fig. O3)

A primary feature of the ParKlump system is its ability to accommodate stacking of a series of clamps to various heights, thus requiring a smaller footprint for mounting. To do this, simply use the stacking bolts to mount the first clamp assembly, then install a stacking plate over the first clamp and stacking bolts. The second clamp assembly can then be placed over the first clamp assembly. Complete the mounting by assembling a cover plate and using the hex head bolts to tighten the upper clamp assembly. **Note: When stacking, the clamps must be from the same series and group.**



Fig. O3 – Stacked Assembly

Dimensions and pressures for reference only, subject to change.

Shearing Force Diagram

The forces shown in these diagrams represent the resistance to sliding provided by the clamps in the axial direction.

The sliding starts when the shown values are reached.

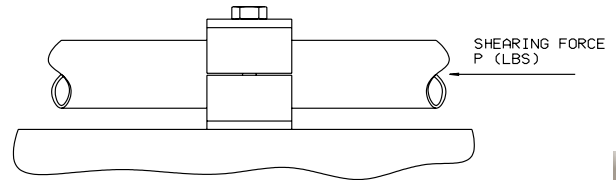


TABLE OF CONTENTS

VISUAL INDEX

STANDARD SERIES					
Clamp Group	Hexagon Head Bolt	Polypropylene			
		Tightening torque [Nm] Ft/lb		Max. load in pipe direction F [kN] lbf	
1		8	6	0,6	135
1A		8	6	1,1	247
2	M6 / 1/4"-20	8	6	1,3	292
3	UNC	8	6	1,4	315
4		8	6	1,5	337
5		8	6	1,9	427
6		8	6	2,0	450

HEAVY SERIES					
Clamp Group	Hexagon Head Bolt	Polypropylene			
		Tightening torque [Nm] Ft/lb		Max. load in pipe direction F [kN] lbf	
3S	M10 / 3/8"-	12	9	1,6	360
4S	16 UNC	12	9	2,9	652
5S	M12 / 7/16" -	15	11	3,3	742
6S	14 UNC	30	12	8,2	1.843

Clamp Body Material Properties

	Polypropylene PP
MECHANICAL PROPERTIES	
Density	.901g/cc
Tensile Strength	25 MPa (4,000 psi)
Flexural Modulus	1073 MPa
Compressive Strength	90MPa (23,050 psi)
(Resistance)	
Notched IZOD Impact Strength	3.1 KJ/mm ²

	Polypropylene PP
THERMAL PROPERTIES	
Max. Temperature	-30° to +90° C
Resistance	-22° to +194°F
ELECTRICAL PROPERTIES	
Specific Volume	
Resistivity Ohm x Inch	3.9 x 10 ¹⁷
CHEMICAL PROPERTIES	
Light Acids, Solvents	Stable
Fuels, Mineral Oils	Stable
Alcohol, Paints, Saltwater	Stable

Dimensions and pressures for reference only, subject to change.

How to Order ParKlamp Kits

Select a symbol from Box 1 and pair it with a symbol from Box 2 to create a part number for the kit.

Example: Weld Plate Kit – Twin Series for 3/4" tube.

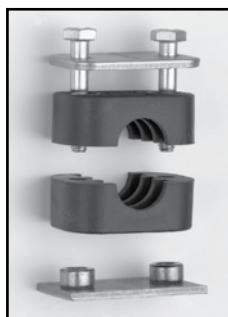
Box 1	Box 2
WPT	3190

TABLE
OF
CONTENTS

VISUAL
INDEX

Box 1 : Mounting – Assembly Type	
Symbol	Description
WP	Weld Plate Kit – Standard Series
WPH	Weld Plate Kit – Heavy Series
WPE	Elongated Weld Plate Kit – Standard Series
WPT	Weld Plate Kit – Twin Series
RN	Rail Nut Kit – Standard Series
RNH	Rail Nut Kit – Heavy Series
RNT	Rail Nut Kit – Twin Series
SA	Stacked Assembly Kit – Standard Series
SAH	Stacked Assembly Kit – Heavy Series
SAT	Stacked Assembly Kit – Twin Series

Box 2: Clamp Half – Size/Type Designation			
Symbol	Size	Type	Series
1064	1/4"	Tube	Standard – Twin
1064A	1/4"	Tube	Standard
3134H	1/4"	100R1 Hose	Standard
4150H	1/4"	100R2 Hose	Heavy
1095	3/8"	Tube	Standard – Twin
3095	3/8"	Tube	Heavy
1095A	3/8"	Tube	Standard
3174H	3/8"	100R1 Hose	Standard
4198H	3/8"	100R2 Hose	Heavy
2127	1/2"	Tube	Standard
3127	1/2"	Tube	Standard
3205H	1/2"	100R1 Hose	Standard
4221H	1/2"	100R2 Hose	Heavy
3213	1/2"	Pipe	Standard
4213	1/2"	Pipe	Heavy
2160	5/8"	Tube	Standard – Twin
3160	5/8"	Tube	Heavy
3239H	5/8"	100R1 Hose	Standard
4251H	5/8"	100R2 Hose	Heavy
3190	3/4"	Tube	Standard – Twin
4190	3/4"	Tube	Heavy
5278H	3/4"	100R1 Hose	Standard
4292H	3/4"	100R2 Hose	Heavy
4266	3/4"	Pipe	Standard – Twin
4267	3/4"	Pipe	Heavy
3254	1"	Tube	Standard – Twin
4254	1"	Tube	Heavy
5357H	1"	100R1 Hose	Standard
6378H	1"	100R2 Hose	Heavy
5334	1"	Pipe	Standard – Heavy – Twin
5320	1 1/4"	Tube	Standard – Heavy – Twin
5438H	1 1/4"	100R1 Hose	Standard
6484H	1 1/4"	100R2 Hose	Heavy
5422	1 1/4"	Pipe	Heavy
5381	1 1/2"	Tube	Standard – Heavy – Twin
6498H	1 1/2"	100R1 Hose	Standard
6544H	1 1/2"	100R2 Hose	Heavy
6483	1 1/2"	Pipe	Standard – Heavy
6508	2"	Tube	Standard – Heavy
6603	2"	Pipe	Heavy
6635	2 1/2"	Tube	Heavy
7762	3"	Tube	Heavy



Weld Plate Kit



Mounting Rail Kit

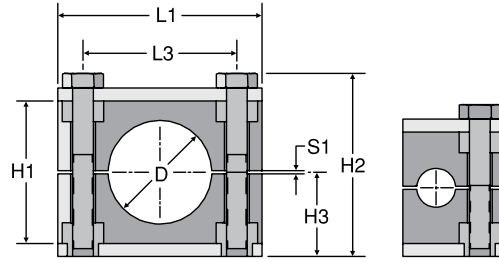


Stacked Assembly Kit

Dimensions and pressures for reference only, subject to change.

Clamp Halves

Standard Series



Groups 1A, 2, 3, 4, 5 and 6 Group 1

See note below

TUBE CLAMP HALVES											
PART #	TUBE SIZE	GROUP #	D		H1	H2	H3	L1	L3	S1	STANDARD FROM STOCK
			in.	mm	in.	in.	in.	in.	in.	in.	
1064-PP	1/4	1	0.25	6.4	1.06	1.45	0.65	1.02	NA	0.01	•
1095-PP	3/8	1	0.38	9.5	1.06	1.45	0.65	1.02	NA	0.01	•
1064A-PP	1/4	1A	0.25	6.4	1.06	1.45	0.65	1.45	0.78	0.01	•
1095A-PP	3/8	1A	0.38	9.5	1.06	1.45	0.65	1.45	0.78	0.01	•
2127-PP	1/2	2	0.50	12.7	1.29	1.69	0.77	1.65	1.02	0.01	•
2160-PP	5/8	2	0.63	16.0	1.29	1.69	0.77	1.65	1.02	0.01	•
3190-PP	3/4	3	0.75	19.0	1.41	1.77	0.80	1.96	1.29	0.01	•
3254-PP	1	3	1.00	25.4	1.41	1.77	0.80	1.96	1.29	0.01	•
5320-PP	1 1/4	5	1.25	32.0	2.28	2.72	1.28	2.79	2.04	0.03	•
5381-PP	1 1/2	5	1.50	38.1	2.28	2.72	1.28	2.79	2.04	0.03	•
6508-PP	2	6	2.00	50.8	2.59	3.00	1.42	3.38	2.59	0.03	•

PIPE CLAMP HALVES											
PART #	PIPE SIZE	GROUP #	D		H1	H2	H3	L1	L3	S1	STANDARD FROM STOCK
			in.	mm	in.	in.	in.	in.	in.	in.	
3213-PP	1/2	3	0.84	21.3	1.41	1.77	0.80	1.96	1.29	0.01	•
4266-PP	3/4	4	1.05	26.6	1.65	2.09	0.96	2.32	1.57	0.01	•
5334-PP	1	5	1.31	33.4	2.28	2.72	1.28	2.79	2.04	0.03	•
6483-PP	1 1/2	6	1.90	48.3	2.59	3.00	1.42	3.38	2.59	0.03	•

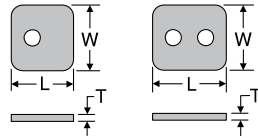
100R1 HOSE CLAMP HALVES											
PART #	HOSE SIZE	GROUP #	D		H1	H2	H3	L1	L3	S1	STANDARD FROM STOCK
			in.	mm	in.	in.	in.	in.	in.	in.	
H3134PP	1/4	3	0.53	13.4	1.41	1.77	0.80	1.96	1.29	0.01	•
H3174PP	3/8	3	0.69	17.4	1.41	1.77	0.80	1.96	1.29	0.01	•
H3205PP	1/2	3	0.81	20.5	1.41	1.77	0.80	1.96	1.29	0.01	•
H3239PP	5/8	3	0.94	23.9	1.41	1.77	0.80	1.96	1.29	0.01	•
H5278PP	3/4	5	1.09	27.8	2.28	2.72	1.28	2.79	2.04	0.03	•
H5357PP	1	5	1.41	35.7	2.28	2.72	1.28	2.79	2.04	0.03	•
H5438PP	1 1/4	5	1.72	43.8	2.28	2.72	1.28	2.79	2.04	0.03	•
H6498PP	1 1/2	6	1.96	49.8	2.59	3.00	1.42	3.38	2.59	0.03	•

Note: One clamp set includes two identical halves of polypropylene. Tube and pipe clamp halves are black in color. Hose clamp halves are green in color. Hardware shown in the illustrations above is **not** included.

Other sizes available. Please contact TFD for a quote.

Dimensions and pressures for reference only, subject to change.

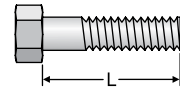
CP
Cover Plate



TUBE FITTING PART #	GROUP #	L LENGTH (in.)	W WIDTH (in.)	T THICKNESS (in.)	STANDARD FROM STOCK	
					-S	-SS
CP-1	1	1.10	1.18	0.11	•	•
CP-1A	1A	1.33	1.18	0.11	•	•
CP-2	2	1.59	1.18	0.11	•	•
CP-3	3	1.88	1.18	0.11	•	•
CP-4	4	2.24	1.18	0.11	•	•
CP-5	5	2.75	1.18	0.11	•	•
CP-6	6	3.38	1.18	0.11	•	•

Material: Steel: Zinc nickel plated
SS: 316 stainless steel

BCP
Hexagon Head Bolt for Cover Plate
(2 required for Groups 1A-6)



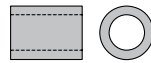
TUBE FITTING PART #	GROUP #	L LENGTH (in.)	STANDARD FROM STOCK	
			-S	-SS
BCP-1	1	1.25	•	•
BCP-1A	1A	1.25	•	•
BCP-2	2	1.38	•	•
BCP-3	3	1.50	•	•
BCP-4	4	1.88	•	•
BCP-5	5	2.38	•	•
BCP-6	6	2.75	•	•

Note: Bolt threads are 1/4 - 20 UNC, Grade 5, zinc clear chromate plated
Material: SS: 316 stainless steel

TABLE OF CONTENTS

VISUAL INDEX

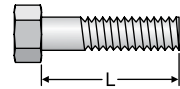
IPS
Insert



TUBE FITTING PART #	STANDARD FROM STOCK
IPS	•

Material: Plastic
One size fits all groups (2 required for Groups 1A - 6).
(Use when not using a cover plate.)

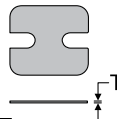
BIP
Hexagon Head Bolt for Insert



TUBE FITTING PART #	GROUP #	L LENGTH (in.)	STANDARD FROM STOCK
BIP-1	1	1.13	•
BIP-1A	1A	1.13	•
BIP-2	2	1.38	•
BIP-3	3	1.38	•
BIP-4	4	1.63	•
BIP-5	5	2.38	•
BIP-6	6	2.75	•

Note: Bolt threads are 1/4 - 20 UNC, Grade 5, zinc clear chromate plated

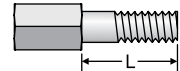
LP
Locking Plate



TUBE FITTING PART #	GROUP #	T THICKNESS (in.)	STANDARD FROM STOCK
LP-1	1	0.03	•
LP-1A	1A	0.03	•
LP-2	2	0.03	•
LP-3	3	0.03	•
LP-4	4	0.03	•
LP-5	5	0.03	•
LP-6	6	0.03	•

Material: Steel, zinc nickel plated

SB
Stacking Bolt
(2 required for Groups 1A-6)

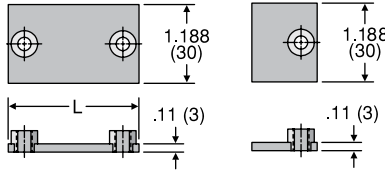


TUBE FITTING PART #	GROUP #	L LENGTH (in.)	STANDARD FROM STOCK
SB-1	1	0.78	•
SB-1A	1A	0.78	•
SB-2	2	1.00	•
SB-3	3	1.18	•
SB-4	4	1.38	•
SB-5	5	1.96	•
SB-6	6	2.36	•

Note: Bolt threads are 1/4 - 20 UNC, 1010 steel, zinc nickel plated

Dimensions and pressures for reference only, subject to change.

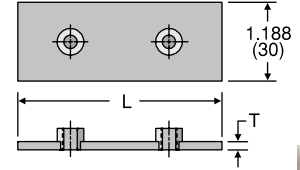
WP
Weld Plate



TUBE FITTING PART #	GROUP #	L LENGTH		STANDARD FROM STOCK	
		(in.)	(mm)	-S	-SS
WP-1	1	1.25	31.5	•	•
WP-1A	1A	1.41	36	•	•
WP-2	2	1.65	42	•	•
WP-3	3	1.96	50	•	•
WP-4	4	2.36	60	•	•
WP-5	5	2.79	71	•	•
WP-6	6	3.46	88	•	•

Material: Steel: 1020 steel, zinc-phosphate plated
SS: 316 stainless steel

WPE
Weld Plate Elongated

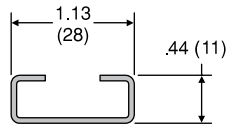


TUBE FITTING PART #	GROUP #	L LENGTH		T THICKNESS	STANDARD FROM STOCK
		(in.)	(mm)	(in.)	
WPE-1	1	2.28	58	0.11	•
WPE-1A	1A	2.51	64	0.11	•
WPE-2	2	2.75	70	0.11	•
WPE-3	3	3.07	78	0.11	•
WPE-4	4	3.42	87	0.11	•
WPE-5	5	3.93	100	0.11	•
WPE-6	6	4.52	115	0.11	•

Material: 1020 steel, zinc-phosphate plated



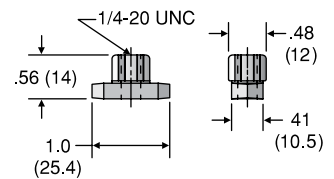
R
Mounting Rail



TUBE FITTING PART #	LENGTH	STANDARD FROM STOCK	
		-S	-SS
R-1	3.28 ft. (1 meter)	•	•
R-2	6.56 ft. (2 meters)	•	•

Material: Steel: Unplated
SS: 316 stainless steel

HRN
Hexagon Rail Nut



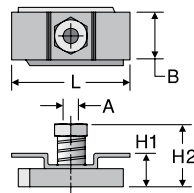
TUBE FITTING PART #	STANDARD FROM STOCK	
	-S	-SS
HRN	•	•

Material: Steel: Zinc nickel plated
SS: 316 stainless steel

Note: To be used with mounting rail (R)



CRA
Channel Rail Adapter



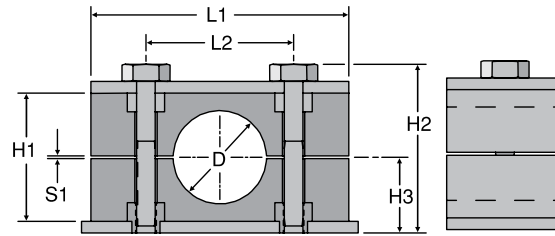
TUBE FITTING PART #	THREAD "A" UNC	L in. (mm)	B in. (mm)	H1 in. (mm)	H2 in. (mm)	STANDARD FROM STOCK
CRA 1-8	1/4-20	1.37 (35)	0.74 (19)	0.51 (13)	0.77 (19.5)	•

Material: Steel, zinc nickel plated

Dimensions and pressures for reference only, subject to change.

Clamp Halves

Heavy Series



See note below

TABLE
OF
CONTENTS

VISUAL
INDEX

TUBE CLAMP HALVES											
PART #	TUBE SIZE	GROUP #	D		H1 (in.)	H2 (in.)	H3 (in.)	L1 (in.)	L2 (in.)	S1 (in.)	STANDARD FROM STOCK
			(in.)	(mm)							
3095-HPP	3/8	H3	0.37	9.5	1.25	2.17	0.94	2.16	1.29	0.02	•
3127-HPP	1/2	H3	0.50	12.7	1.25	2.17	0.94	2.16	1.29	0.02	•
3160-HPP	5/8	H3	0.63	16.0	1.25	2.17	0.94	2.16	1.29	0.02	•
4190-HPP	3/4	H4	0.75	19.0	1.88	2.80	1.26	2.75	1.77	0.02	•
4254-HPP	1	H4	1.00	25.4	1.88	2.80	1.26	2.75	1.77	0.02	•
5320-HPP	1 1/4	H5	1.25	32.0	2.36	3.27	1.50	3.34	2.36	0.02	•
5381-HPP	1 1/2	H5	1.50	38.1	2.36	3.27	1.50	3.34	2.36	0.02	•
6508-HPP	2	H6	2.00	50.8	3.50	4.61	2.17	4.52	3.54	0.07	•
6635-HPP	2 1/2	H6	2.50	63.5	3.50	4.61	2.17	4.52	3.54	0.07	•
7762-HPP	3	H7	3.00	76.2	4.72	5.74	2.75	5.98	4.80	0.07	•

PIPE CLAMP HALVES											
PART #	PIPE SIZE	GROUP #	D		H1 (in.)	H2 (in.)	H3 (in.)	L1 (in.)	L2 (in.)	S1 (in.)	STANDARD FROM STOCK
			(in.)	(mm)							
4213-HPP	1/2	H4	0.84	21.3	1.88	2.80	1.26	2.75	1.77	0.02	•
4267-HPP	3/4	H4	1.05	26.7	1.88	2.80	1.26	2.75	1.77	0.02	•
5334-HPP	1	H5	1.31	33.4	2.36	3.27	1.50	3.34	2.36	0.02	•
5422-HPP	1 1/4	H5	1.66	42.2	2.36	3.27	1.50	3.34	2.36	0.02	•
6483-HPP	1 1/2	H6	1.90	48.3	3.50	4.61	2.17	4.52	3.54	0.07	•
6603-HPP	2	H6	2.37	60.3	3.50	4.61	2.17	4.52	3.54	0.07	•

100R2 HOSE CLAMP HALVES											
PART #	HOSE SIZE	GROUP #	D		H1 (in.)	H2 (in.)	H3 (in.)	L1 (in.)	L2 (in.)	S1 (in.)	STANDARD FROM STOCK
			(in.)	(mm)							
H4150HPP	1/4	H4	0.59	15.0	1.83	2.80	1.26	2.75	1.77	0.02	•
H4198HPP	3/8	H4	0.78	19.8	1.83	2.80	1.26	2.75	1.77	0.02	•
H4221HPP	1/2	H4	0.87	22.1	1.83	2.80	1.26	2.75	1.77	0.02	•
H4251HPP	5/8	H4	0.99	25.1	1.83	2.80	1.26	2.75	1.77	0.02	•
H4292HPP	3/4	H4	1.15	29.2	1.83	2.80	1.26	2.75	1.77	0.02	•
H6378HPP	1	H6	1.49	37.8	3.42	4.61	2.17	4.52	3.54	0.07	•
H6484HPP	1 1/4	H6	1.91	48.4	3.42	4.61	2.17	4.52	3.54	0.07	•
H6544HPP	1 1/2	H6	2.14	54.4	3.42	4.61	2.17	4.52	3.54	0.07	•

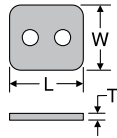
Note: One clamp set includes two identical halves of polypropylene. Tube and pipe clamps are black in color. Hose clamp halves are green in color. Hardware shown in the illustration above is **not** included.

Dimensions and pressures for reference only, subject to change.



CPH

Cover Plate Heavy

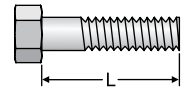


TUBE FITTING PART #	GROUP #	L LENGTH (in.)	W WIDTH (in.)	T THICKNESS		STANDARD FROM STOCK	
				(in.)	(mm)	-S	-SS
CPH-3	H3	2.16	1.18	0.31	8	•	•
CPH-4	H4	2.75	1.18	0.31	8	•	•
CPH-5	H5	3.34	1.18	0.31	8	•	•
CPH-6	H6	4.52	1.77	0.39	10	•	•
CPH-7	H7	5.98	2.36	0.39	10	•	•

Material: Steel: Zinc phosphate plated
SS: 316 stainless steel

BCPH

Hexagon Head Bolt for Cover Plate
(2 required per clamp set)



TUBE FITTING PART #	GROUP #	L LENGTH (in.)	UNC THREAD	STANDARD FROM STOCK	
				-S	-SS
BCPH-3	H3	1.75	3/8 - 16	•	•
BCPH-4	H4	2.25	3/8 - 16	•	•
BCPH-5	H5	2.75	3/8 - 16	•	•
BCPH-6	H6	4.00	7/16 - 14	•	•
BCPH-7	H7	5.25	5/8 - 11	•	•

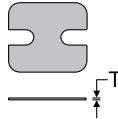
Material: Steel: Zinc clear chromate plated, Grade 5 bolt
SS: 316 stainless steel

TABLE OF CONTENTS

VISUAL INDEX

LPH

Locking Plate Heavy

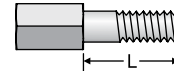


TUBE FITTING PART #	GROUP #	T THICKNESS (in.)	STANDARD FROM STOCK
LPH-3	H3	0.31	•
LPH-4	H4	0.31	•
LPH-5	H5	0.31	•
LPH-6	H6	0.39	•
LPH-7	H7	0.39	•

Material: Steel, zinc phosphate plated

SBH

Stacking Bolt Heavy
(2 required per clamp set)



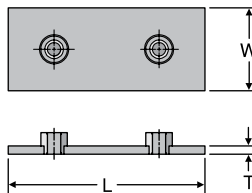
TUBE FITTING PART #	GROUP #	L LENGTH (in.)	STANDARD FROM STOCK
SBH-3	H3	1.02	•
SBH-4	H4	1.61	•
SBH-5	H5	2.01	•
SBH-6	H6	3.27	•
SBH-7	H7	4.33	•

Material: 1010 steel, zinc nickel plated

O

WPH

Weld Plate Heavy

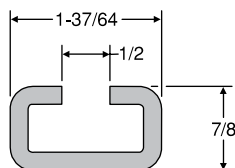


TUBE FITTING PART #	GROUP #	L LENGTH		W WIDTH		T THICKNESS		STANDARD FROM STOCK	
		(in.)	(mm)	(in.)	(mm)	(in.)	(mm)	-S	-SS
WPH-3	H3	2.88	73	1.18	30	0.31	8	•	•
WPH-4	H4	3.34	85	1.18	30	0.31	8	•	•
WPH-5	H5	3.94	100	1.18	30	0.31	8	•	•
WPH-6	H6	5.51	140	1.79	45	0.39	10	•	•
WPH-7	H7	7.09	180	2.36	60	0.39	10	•	•

Material: Steel: 1020 steel, zinc-phosphate plated
SS: 316 stainless steel

Dimensions and pressures for reference only, subject to change.

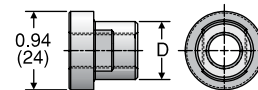
RH
Mounting Rail Heavy



TUBE FITTING PART #	LENGTH	STANDARD FROM STOCK	
		-S	-SS
R1H	3.28 ft. (1 meter)	•	•
R2H	6.56 ft. (2 meters)	•	•

Material: Steel: Unplated
SS: 316 stainless steel

RNH
Mounting Rail Nut Heavy



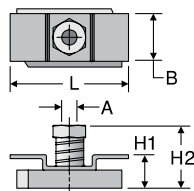
TUBE FITTING PART #	GROUP #	D DIAMETER		THREAD	STANDARD FROM STOCK	
		(in.)	(mm)		-S	-SS
RNH-10	H3, H4, H5	0.70	18	3/8 - 16 UNC	•	•
RNH-12	H6	0.78	20	7/16 - 14 UNC	•	•

Material: Steel: Zinc-phosphate plated
SS: 316 stainless steel

Note: To be used with mounting rail heavy (RH)



CRA
Channel Rail Adapter



TUBE FITTING PART #	THREAD "A" UNC	L in. (mm)	B in. (mm)	H1 in. (mm)	H2 in. (mm)	STANDARD FROM STOCK
CRA 3-5	3/8-16	1.37 (35)	0.86 (22)	0.73 (18.5)	1.08 (27.5)	•
CRA 6	7/16-14	1.77 (45)	0.98 (25)	0.67 (17)	1.08 (27.5)	•

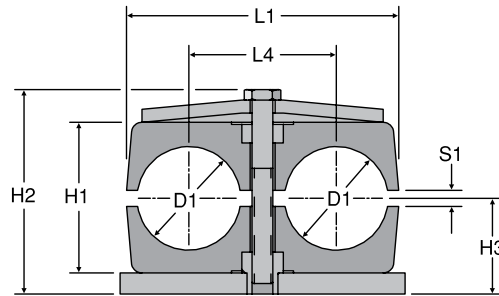
Material: Steel, zinc plated, blue chromate

Note: To be used with channel rails (Parker does not supply these).

Dimensions and pressures for reference only, subject to change.

Clamp Halves

Twin Series



See note below

TABLE OF CONTENTS

VISUAL INDEX

TUBE CLAMP HALVES											
PART #	TUBE SIZE	GROUP #	D1		H1	H2	H3	L1	L4	S1	STANDARD FROM STOCK
			in.	mm	in.	in.	in.	in.	in.	in.	
1064/64-PP	1/4	T1	0.25	6.4	0.79	1.18	0.59	1.41	0.78	0.02	•
1095/95-PP	3/8	T1	0.38	9.5	0.79	1.18	0.59	1.41	0.78	0.02	•
2127/127-PP	1/2	T2	0.50	12.7	1.06	1.73	0.71	2.08	1.14	0.03	•
2160/160-PP	5/8	T2	0.63	16.0	1.06	1.73	0.71	2.08	1.14	0.03	•
3190/190-PP	3/4	T3	0.75	19.0	1.45	2.17	0.93	2.63	1.41	0.03	•
3254/254-PP	1	T3	1.00	25.4	1.45	2.17	0.93	2.63	1.41	0.03	•
5320/320-PP	1 1/4	T5	1.25	32.0	2.09	2.83	1.26	4.17	2.20	0.03	•
5381/381-PP	1 1/2	T5	1.50	38.1	2.09	2.83	1.26	4.17	2.20	0.03	•

PIPE CLAMP HALVES											
PART #	PIPE SIZE	GROUP #	D1		H1	H2	H3	L1	L4	S1	STANDARD FROM STOCK
			in.	mm	in.	in.	in.	in.	in.	in.	
4266/266-PP	3/4	T4	1.05	26.6	1.77	2.36	1.02	3.14	1.77	0.03	•
5334/334-PP	1	T5	1.31	33.4	2.08	2.83	1.26	4.17	2.20	0.03	•

FOR USE WITH 100R1 HOSE											
PART #	HOSE SIZE	GROUP #	D1		H1	H2	H3	L1	L2	S1	STANDARD FROM STOCK
			in.	mm	in.	in.	in.	in.	in.	in.	
H3206/206-PP	1/2	T3	0.81	20.6	1.45	2.17	0.93	2.63	1.41	0.03	•
H5205/205-PP	1/2	T5	0.81	20.5	2.09	2.83	1.26	4.17	2.20	0.03	•
H5230/230-PP	5/8	T5	0.91	23.0	2.09	2.83	1.26	4.17	2.20	0.03	•
H5280/280-PP	3/4	T5	1.10	28.0	2.09	2.83	1.26	4.17	2.20	0.03	•

FOR USE WITH 100R2 HOSE											
PART #	HOSE SIZE	GROUP #	D1		H1	H2	H3	L1	L2	S1	STANDARD FROM STOCK
			in.	mm	in.	in.	in.	in.	in.	in.	
H3190/190-PP	3/8	T3	0.75	19.0	1.45	2.17	0.93	2.63	1.41	0.03	•
H3222/222-PP	1/2	T3	0.87	22.2	1.45	2.17	0.93	2.63	1.41	0.03	•
H3250/250-PP	5/8	T3	0.98	25.0	1.45	2.17	0.93	2.63	1.41	0.03	•
H5295/295-PP	3/4	T5	1.16	29.5	2.09	2.83	1.26	4.17	2.20	0.03	•
H5372/372-PP	1	T5	1.46	37.2	2.09	2.83	1.26	4.17	2.20	0.03	•

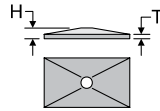
Note: One clamp set includes two identical halves of polypropylene. Tube and pipe clamp halves are black in color. Hose clamp halves are green. Hardware shown in the illustration above is **not** included.

Dimensions and pressures for reference only, subject to change.



CPT

Cover Plate

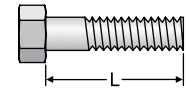


TUBE FITTING PART #	GROUP #	T THICKNESS		H HEIGHT		STANDARD FROM STOCK	
		(in.)	(mm)	(in.)	(mm)	-S	-SS
CPT-1	T1	0.06	1.5	—	—	•	•
CPT-2	T2	0.13	3.0	0.28	7.0	•	•
CPT-3	T3	0.13	3.0	0.28	7.0	•	•
CPT-4	T4	0.13	3.0	0.31	8.0	•	•
CPT-5	T5	0.13	3.0	0.31	8.0	•	•

Material: Steel: Zinc nickel plated
 SS: 316 stainless steel

BCPT

Hexagon Head Bolt for Cover Plate



TUBE FITTING PART #	GROUP #	L LENGTH (in.)	UNC THREAD	STANDARD FROM STOCK	
				-S	-SS
BCPT-1	T1	1.38	1/4 - 20	•	•
BCPT-2	T2	1.38	5/16 - 18	•	•
BCPT-3	T3	1.75	5/16 - 18	•	•
BCPT-4	T4	2.00	5/16 - 18	•	•
BCPT-5	T5	2.50	5/16 - 18	•	•

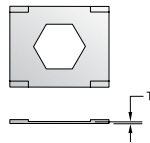
Material: Steel: Zinc clear chromate plated, Grade 10 material
 SS: 316 stainless steel

TABLE OF CONTENTS

VISUAL INDEX

LPT

Locking Plate

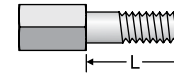


TUBE FITTING PART #	GROUP #	T THICKNESS (in.)	STANDARD FROM STOCK
LPT-1	T1	0.02	•
LPT-2	T2	0.02	•
LPT-3	T3	0.02	•
LPT-4	T4	0.02	•
LPT-5	T5	0.02	•

Material: Steel, zinc nickel plated

SBT

Stacking Bolt

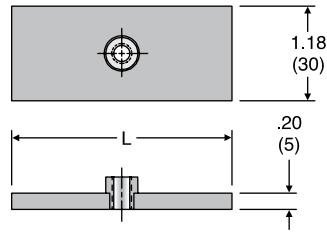


TUBE FITTING PART #	GROUP #	L LENGTH (in.)	UNC THREAD	STANDARD FROM STOCK
SBT-1	T1	0.59	1/4 - 20	•
SBT-2	T2	0.78	5/16 - 18	•
SBT-3	T3	1.13	5/16 - 18	•
SBT-4	T4	1.69	5/16 - 18	•
SBT-5	T5	1.78	5/16 - 18	•

Material: Zinc nickel plated, 1010 steel

Dimensions and pressures for reference only, subject to change.

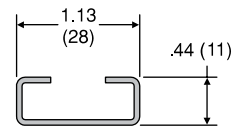
WPT
Weld Plate Twin



TUBE FITTING PART #	GROUP #	L LENGTH		STANDARD FROM STOCK	
		(in.)	(mm)	-S	-SS
WPT-1	T1	1.47	37	•	•
WPT-2	T2	2.31	55	•	•
WPT-3	T3	2.75	70	•	•
WPT-4	T4	3.34	85	•	•
WPT-5	T5	4.34	110	•	•

Material: Steel: Zinc-phosphate plated
SS: 316 stainless steel

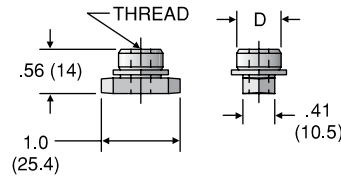
R
Mounting Rail



TUBE FITTING PART #	LENGTH	STANDARD FROM STOCK	
		-S	-SS
R-1	3.28 ft. (1 meter)	•	•
R-2	6.56 ft. (2 meters)	•	•

Material: Steel: Unplated
SS: 316 stainless steel

RNT
Mounting Rail Nut Twin

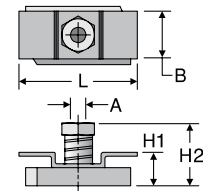


TUBE FITTING PART #	GROUP #	D DIAMETER		THREAD	STANDARD FROM STOCK	
		(in.)	(mm)		-S	-SS
RNT-1	T1	0.39	10	1/4 - 20 UNC	•	•
RNT-2-5	T2-T5	0.56	14	5/16 - 18 UNC	•	•

Material: Steel: Zinc nickel plated
SS: 316 stainless steel

Note: to be used with mounting rail (R)

CRA
Channel Rail Adapter



TUBE FITTING PART #	THREAD "A" UNC	L in. (mm)	B in. (mm)	H1 in. (mm)	H2 in. (mm)	STANDARD FROM STOCK
CRA 2-3D	5/16-18	1.49 (38)	2.55 (65)	0.73 (18.5)	1.08 (27.5)	•

Material: Steel, zinc plated, blue chromate

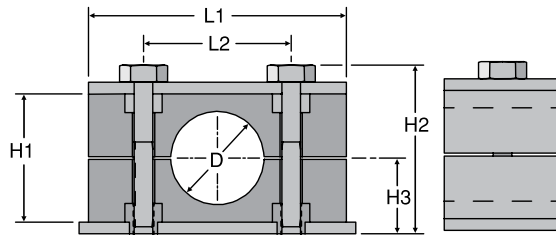
Dimensions and pressures for reference only, subject to change.

Clamp Halves

Compact Spiral Hose Heavy Series

TABLE
 OF
 CONTENTS

VISUAL
 INDEX



See note below

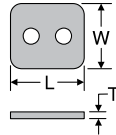
COMPACT SPIRAL HOSE CLAMP HALVES										
PART #	HOSE SIZE	GROUP #	D		H1 (in.)	H2 (in.)	H3 (in.)	L1 (in.)	L2 (in.)	STANDARD FROM STOCK
			(in.)	(mm)						
H4213-HPP	-8	H4	0.84	21.3	1.83	2.80	1.26	2.75	1.77	•
H4250-HPP	-10	H4	0.98	25.0	1.83	2.80	1.26	2.75	1.77	•
H4280-HPP	-12	H4	1.10	28.0	1.83	2.80	1.26	2.75	1.77	•
H6354-HPP	-16	H6	1.39	35.4	3.42	4.61	2.17	4.52	3.54	•
H6445-HPP	-20	H6	1.75	44.5	3.42	4.61	2.17	4.52	3.54	•
H6530-HPP	-24	H6	2.09	53.0	3.42	4.61	2.17	4.52	3.54	•
H6680-HPP	-32	H6	2.68	68.0	3.42	4.61	2.17	4.52	3.54	•

Note: One clamp set includes two identical halves of polypropylene. Hardware shown in the illustration above is **not** included.

Dimensions and pressures for reference only, subject to change.

CPH

Cover Plate Heavy

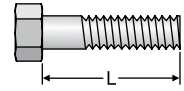


TUBE FITTING PART #	GROUP #	L LENGTH (in.)	W WIDTH (in.)	T THICKNESS		STANDARD FROM STOCK	
				(in.)	(mm)	-S	-SS
CPH-4	H4	2.75	1.18	0.31	8	•	•
CPH-6	H6	4.52	1.77	0.39	10	•	•

Material: Steel: Zinc nickel plated

BCPH

Hexagon Head Bolt for Cover Plate
(2 required per clamp set)



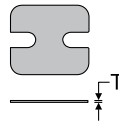
TUBE FITTING PART #	GROUP #	L LENGTH (in.)	UNC THREAD	STANDARD FROM STOCK	
				-S	-SS
BCPH-4	H4	2.25	3/8 - 16	•	•
BCPH-6	H6	4.00	7/16 - 14	•	•

Material: Steel: Zinc clear chromate plated, Grade 5 bolt
SS: 316 stainless steel



LPH

Locking Plate Heavy

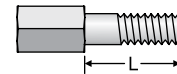


TUBE FITTING PART #	GROUP #	T THICKNESS (in.)	STANDARD FROM STOCK
LPH-4	H4	0.31	•
LPH-6	H6	0.39	•

Material: Steel: Zinc nickel plated

SBH

Stacking Bolt Heavy
(2 required per clamp set)

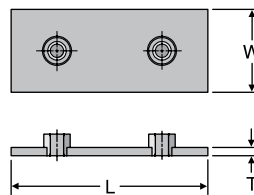


TUBE FITTING PART #	GROUP #	L LENGTH (in.)	STANDARD FROM STOCK
SBH-4	H4	1.61	•
SBH-6	H6	3.27	•

Material: Steel: Zinc nickel plated

WPH

Weld Plate Heavy



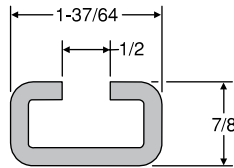
TUBE FITTING PART #	GROUP #	L LENGTH		W WIDTH		T THICKNESS		STANDARD FROM STOCK	
		(in.)	(mm)	(in.)	(mm)	(in.)	(mm)	-S	-SS
WPH-4	H4	3.34	85	1.18	30	0.31	8	•	•
WPH-6	H6	5.51	140	1.79	45	0.39	10	•	•

Material: Steel: Zinc-phosphate plated
SS: 316 stainless steel



Dimensions and pressures for reference only, subject to change.

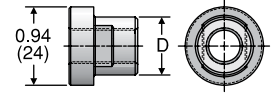
RH
 Mounting Rail Heavy



TUBE FITTING PART #	LENGTH	STANDARD FROM STOCK	
		-S	-SS
R1H	3.28 ft. (1 meter)	•	•
R2H	6.56 ft. (2 meters)	•	•

Material: Steel: Unplated
 SS: 316 stainless steel

RNH
 Mounting Rail Nut Heavy



TUBE FITTING PART #	GROUP #	D DIAMETER		THREAD	STANDARD FROM STOCK	
		(in.)	(mm)		-S	-SS
RNH-10	H4	0.70	18	3/8 - 16 UNC	•	•
RNH-12	H6	0.78	20	7/16 - 14 UNC	•	•

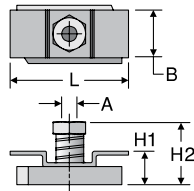
Material: Steel: Zinc nickel plated
 SS: 316 stainless steel

Note: To be used with mounting rail heavy (RH)

TABLE OF CONTENTS

VISUAL INDEX

CRA
 Channel Rail Adapter



TUBE FITTING PART #	GROUP #	THREAD "A" UNC	L in. (mm)	B in. (mm)	H1 in. (mm)	H2 in. (mm)	STANDARD FROM STOCK
CRA 3-5	H4	3/8-16	1.37 (35)	0.86 (22)	0.73 (18.5)	1.08 (27.5)	•
CRA 6	H6	7/16-14	1.77 (45)	0.98 (25)	0.67 (17)	1.08 (27.5)	•

Material: Steel: Zinc nickel plated

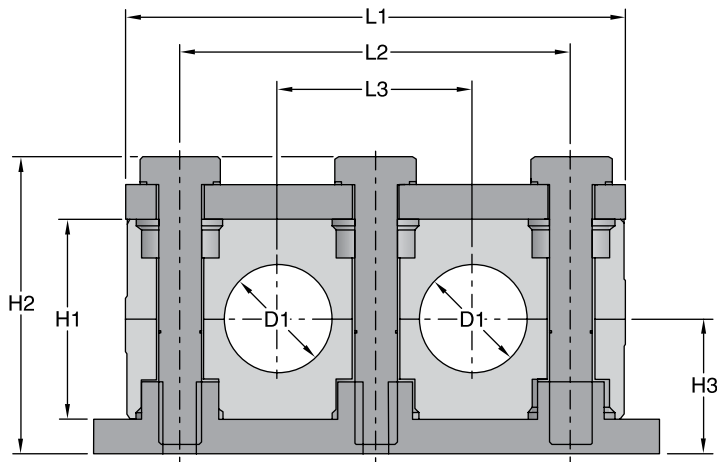
Dimensions and pressures for reference only, subject to change.

Clamp Halves

Compact Spiral Hose Heavy Twin Series

TABLE
 OF
 CONTENTS

VISUAL
 INDEX



See note below

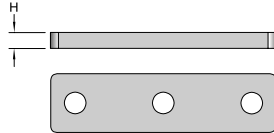
COMPACT SPIRAL HOSE CLAMP HALVES											
PART #	HOSE SIZE	GROUP #	D1		H1 (in.)	H2 (in.)	H3 (in.)	L1 (in.)	L2 (in.)	L3 (in.)	STANDARD FROM STOCK
			(in.)	(mm)							
H4213/213-HPP	-8	HT4	0.84	21.3	1.89	2.77	1.26	4.53	3.54	1.77	•
H4250/250-HPP	-10	HT4	0.98	25.0	1.89	2.77	1.26	4.53	3.54	1.77	•
H4280/280-HPP	-12	HT4	1.10	28.0	1.89	2.77	1.26	4.53	3.54	1.77	•
H5354/354-HPP	-16	HT5	1.39	35.4	2.36	3.24	1.50	5.71	4.72	2.36	•

Note: One clamp set includes two identical halves of polypropylene. Hardware shown in the illustration above is **not** included.

O

Dimensions and pressures for reference only, subject to change.

CPHT
Cover Plate

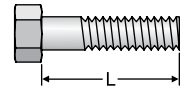


TUBE FITTING PART #	GROUP #	H HEIGHT		STANDARD FROM STOCK	
		(in.)	(mm)	-S	-SS
CPHT-4	HT4	0.31	8.0	•	•
CPHT-5	HT5	0.31	8.0	•	•

Material: Steel: Zinc nickel plated

BCPH

Hexagon Head Bolt for Cover Plate
(2 required per clamp set)

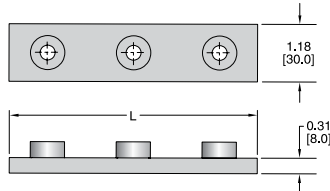


TUBE FITTING PART #	GROUP #	L LENGTH (in.)	UNC THREAD	STANDARD FROM STOCK	
				-S	-SS
BCPH-4	HT4	2.25	3/8 - 16	•	•
BCPH-5	HT5	2.75	3/8 - 16	•	•

Material: Steel: Zinc clear chromate plated, Grade 5 bolt
SS: 316 stainless steel



WPHT
Weld Plate

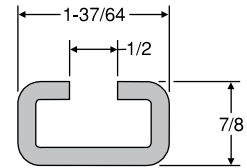


TUBE FITTING PART #	GROUP #	L LENGTH		STANDARD FROM STOCK	
		(in.)	(mm)	-S	-SS
LPHT-4	HT4	5.12	130.0	•	•
LPHT-5	HT5	6.30	160.0	•	•

Material: Steel: Zinc-phosphate plated

RH

Mounting Rail Heavy

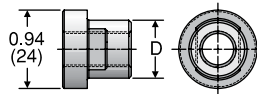


TUBE FITTING PART #	LENGTH	STANDARD FROM STOCK	
		-S	-SS
R1H	3.28 ft. (1 meter)	•	•
R2H	6.56 ft. (2 meters)	•	•

Material: Steel: Unplated
SS: 316 stainless steel

RNH

Mounting Rail Nut Heavy



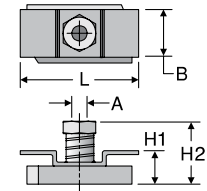
TUBE FITTING PART #	GROUP #	D DIAMETER		THREAD	STANDARD FROM STOCK	
		(in.)	(mm)		-S	-SS
RNH-10	HT4, HT5	0.70	18	3/8 - 16 UNC	•	•

Material: Steel: Zinc nickel plated

Note: To be used with mounting rail heavy (RH)

CRA

Channel Rail Adapter



TUBE FITTING PART #	GROUP #	THREAD "A" UNC	L in. (mm)	B in. (mm)	H1 in. (mm)	H2 in. (mm)	STANDARD FROM STOCK
CRA 3-5	HT4	3/8-16	1.37 (35)	0.86 (22)	0.73 (18.5)	1.08 (27.5)	•

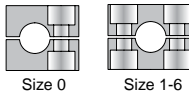




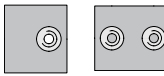
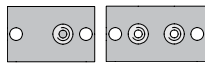
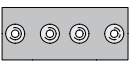
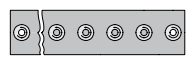
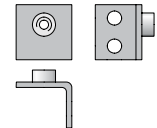

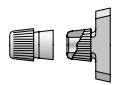
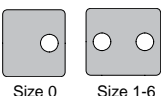
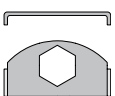

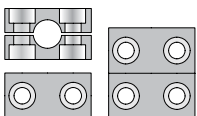







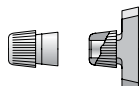
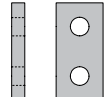
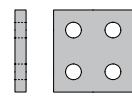


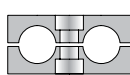



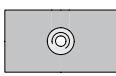
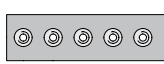

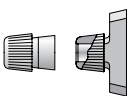
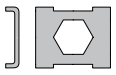
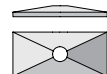

Material: Steel: Zinc nickel plated

Dimensions and pressures for reference only, subject to change.



Metric Clamps

P

<p>Standard Series Normal Mechanical Stress</p>	<p>RAP/RAN/RAA Clamp Halves</p>  <p>Size 0 Size 1-6</p> <p>P4</p>	<p>SLA Slotted Screws</p>  <p>P5</p>	<p>SSLA Hex Head Bolt</p>  <p>P5</p>	<p>ISA Cap Screws</p>  <p>P5</p>	<p>ASA Stacking Bolts</p>  <p>P6</p>
<p>APKA Weld Plate-Short</p>  <p>Size 0 Size 1-6</p> <p>P5</p>	<p>APLA Weld Plate-Long</p>  <p>Size 0 Size 1-6</p> <p>P5</p>	<p>APDA Double Weld Plate</p>  <p>P5</p>	<p>APRA Weld Plate-Strip</p>  <p>P6</p>	<p>APWA Weld Plate Angled</p>  <p>P6</p>	<p>TS Mounting Rail</p>  <p>P6</p>
<p>TMA Lock Nut</p>  <p>P6</p>	<p>DPA Top Plate</p>  <p>Size 0 Size 1-6</p> <p>P6</p>	<p>SBA Locking Plate</p>  <p>P6</p>	<p>USA Locking Washer</p>  <p>P6</p>	<p>Heavy Series High Mechanical Stress</p>	<p>RCP/RCN/RCA/RCPD Clamp Halves</p>  <p>P7</p>
<p>SSC Hex Head Bolts</p>  <p>P8</p>	<p>ASC Stacking Bolts</p>  <p>P8</p>	<p>ISC Cap Screws</p>  <p>P8</p>	<p>APC Weld Plate</p>  <p>P8</p>	<p>APDC Double Weld Plate</p>  <p>P8</p>	<p>APLC Weld/Screw Plate</p>  <p>P8</p>
<p>TSC Mounting Rail</p>  <p>P9</p>	<p>TMC Lock Nut</p>  <p>P9</p>	<p>DPC Top Plate</p>  <p>P9</p>	<p>DPDC Double Top Plate</p>  <p>P9</p>	<p>SPC Locking Plate</p>  <p>P9</p>	<p>USC Locking Washer</p>  <p>P9</p>
<p>Twin Series Normal Mechanical Stress</p>	<p>RBP/RBN Clamp Halves</p>  <p>P10</p>	<p>SSB Hex Head Bolt</p>  <p>P10</p>	<p>ISB Cap Screws</p>  <p>P10</p>	<p>ASB Stacking Bolts</p>  <p>P11</p>	<p>APB Weld Plate</p>  <p>P11</p>
<p>APRB Strip Weld Plate</p>  <p>P11</p>	<p>TS Mounting Rail</p>  <p>P11</p>	<p>TMB Lock Nut</p>  <p>P11</p>	<p>SBB Locking Plate</p>  <p>P11</p>	<p>DPB Top Plate</p>  <p>P11</p>	<p>US Locking Washer</p>  <p>P11</p>

Metric Clamps

The Parker Metric Clamp system is designed for restraining tube, pipe and hose assemblies against unwanted, and potentially harmful effects of mechanical shock and vibration forces that are common in fluid power systems.

The clamping system is the most commonly overlooked aspect of fluid power system design. Failure to properly restrain the fluid conducting system can result in leakage, downtime and system malfunction, as well as significantly reduced life of tube, pipe and hose assemblies. With the Parker Metric Clamp system, the risk of problems resulting from mechanical shock and vibration can be significantly reduced.

How Metric Clamps Work

The Metric Clamp system has two primary methods for mounting: weld plates and mounting rails. Clamps may be mounted to secure a single layer of tube or stacked for securing multiple layers.

Clamps should be mounted to a rigid structure for optimum performance. Clamping tube, pipe or hose assemblies together without mounting them to a rigid structure, often called "floating clamps," does not provide adequate support.

Proper design of a clamping system requires that the clamps be positioned appropriately on the tube, pipe or hose assemblies. See the Assembly and Installation section of the catalog for more information on clamp location and spacing.

Weld Plate Mounting (Fig. P1)

The weld plate mounting system allows the user to attach a single clamp assembly to a structure of similar material (steel to steel, etc) by welding the components together. Once the weld plate is attached to a structure, one clamp half can be placed onto the weld plate, followed by the tube, pipe or hose assembly. Next, the second plastic clamp half can be placed on the tube, pipe or hose assembly, followed by the cover plate. To complete the assembly, the Hex Head attachment bolts are inserted into the assembly and tightened.

Mounting Rail Mounting (Fig. P2)

Use of a mounting rail is another way to assemble the clamping system components onto a support structure. Using a mounting rail allows multiple clamps to be mounted side-by-side for restraining a group of tube, pipe, or hose assemblies. The mounting rail also provides the ability to move the location of the clamps in one direction for easier alignment. The rail can be attached to a support structure by welding or bolting. Once the mounting rail is in place, rail nuts can be slid into the rail. The first clamp half, followed by the tube, pipe or hose assembly, can then be installed over the corresponding rail nuts. After this, the second clamp half, the cover plate and the hex head attachment bolts can be installed to complete the assembly.

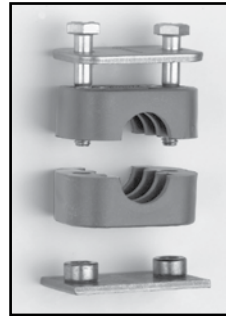


Fig. P1 – Weld Plate Assembly



Fig. P2 – Mounting Rail Assembly

Stacking (Fig. P3)

A primary feature of the Metric Clamp system is its ability to accommodate stacking of a series of clamps to various heights, thus requiring a smaller footprint for mounting. To do this, simply use the stacking bolts to mount the first clamp assembly, then install a stacking plate over the first clamp and stacking bolts. The second clamp assembly can then be placed over the first clamp assembly. Complete the mounting by assembling a cover plate and using the hex head bolts to tighten the upper clamp assembly. **Note: When stacking, the clamps must be from the same series and group.**



Fig. P3 – Stacked Assembly

Reference Locations

Assembly and Installation: Please refer to Section S for the assembly and installation instructions for Metric Clamps.

TABLE OF CONTENTS

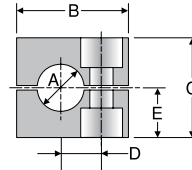
VISUAL INDEX

P

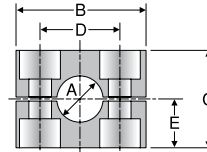
RAP / RAN / RAA

Clamp Halves

TUBE FITTING PART #	GROUP #	A Metric Tube Size	A Inch Pipe Size	A Inch Tube Size	B (mm)	C (mm)	D (mm)	E (mm)
RAP006X		6						
RAP006.4X		6.4		1/4				
RAP008X		8		5/16				
RAP009.5X		9.5		3/8				
RAP010X		10	1/8					
RAP012X	0	12			28	27	12.5	13.5
RAP106X		6						
RAP106.4X		6.4		1/4				
RAP108X		8		5/16				
RAP109.5X		9.5		3/8				
RAP110X		10	1/8					
RAP112X	1	12			34	27	20	13.5
RAP212.7X		12.7		1/2				
RAP213.5X		13.5	1/4					
RAP214X		14						
RAP215X		15						
RAP216X		16		5/8				
RAP217.2X		17.2	3/8					
RAP218X	2	18			40	33	26	16.5
RAP319X		19		3/4				
RAP320X		20						
RAP321.3X		21.3	1/2					
RAP322X		22						
RAP323X		23						
RAP325X	3	25		1	48	35	33	17.5
RAP426.9X		26.9	3/4					
RAP428X		28						
RAP430X	4	30			57	42	40	21
RAP532X		32		1 1/4				
RAP533.7X		33.7	1					
RAP535X		35						
RAP538X		38		1 1/2				
RAP540X		40						
RAP542X	5	42	1 1/4		70	58	52	29
RAP644.5X		44.5		1 3/4				
RAP645X		45						
RAP648X		48	1 1/2					
RAP650X		50						
RAP650.8X		50.8		2				
RAP652X		52						
RAP655X	6	55			86	66	66	33
RAP657X		57	2 1/4					



Group 0



Groups 1-6

Material codes for clamp halves:

- Polypropylene - **RAP**
- inside plain - **RAPG (for hose)**
- Polyamide 6 - **RAN (Nylon)**
- inside plain - **RANG (Nylon) (for hose)**
- Aluminum - **RAA (Group 1 to 6 only)**

TABLE OF CONTENTS

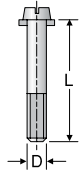
VISUAL INDEX

Dimensions and pressures for reference only, subject to change.

SLA

Slotted Screws

TUBE FITTING PART #	GROUP #	D (mm)	L (mm)
SLA0X	0,1	M6 x 1	20
SLA2X	2	M6 x 1	25
SLA3X	3	M6 x 1	30
SLA4X	4	M6 x 1	35
SLA5X	5	M6 x 1	50
SLA6X	6	M6 x 1	60

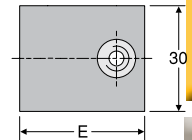


APKA

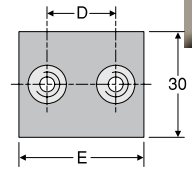
Weld Plate – Short

TUBE FITTING PART #	GROUP #	D (mm)	E (mm)
APKA0X	0	—	30
APKA1X	1	20	36
APKA2X	2	26	42
APKA3X	3	33	50
APKA4X	4	40	59
APKA5X	5	52	72
APKA6X	6	66	88

Thickness 3 mm



Group 0



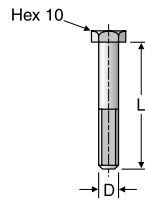
Groups 1-6



SSLA

Hex Head Bolt

TUBE FITTING PART #	GROUP #	D (mm)	L (mm)
SSLA0X	0,1	M6 x 1	30
SSLA2/SSB1X	2	M6 x 1	35
SSLA3X	3	M6 x 1	40
SSLA4X	4	M6 x 1	45
SSLA5X	5	M6 x 1	60
SSLA6X	6	M6 x 1	70

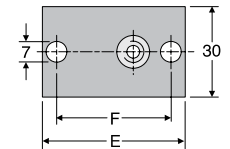


APLA

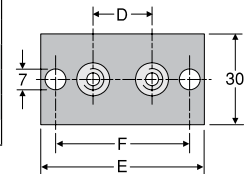
Weld Plate – Long

TUBE FITTING PART #	GROUP #	D (mm)	E (mm)	F (mm)
APLA0X	0	—	58	44
APLA1X	1	20	64	50
APLA2X	2	26	70	56
APLA3X	3	33	78	64
APLA4X	4	40	87	73
APLA5X	5	52	100	86
APLA6X	6	66	116	100

Thickness 3 mm



Group 0

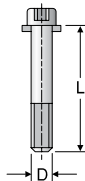


Groups 1-6

ISA

Cap Screws

TUBE FITTING PART #	GROUP #	D (mm)	L (mm)
ISA0X	0,1	M6 x 1	20
ISA2X	2	M6 x 1	25
ISA3X	3	M6 x 1	30
ISA4X	4	M6 x 1	35
ISA5X	5	M6 x 1	50
ISA6X	6	M6 x 1	60

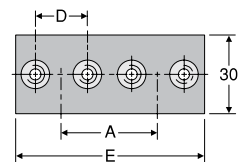


APDA

Double Weld Plate

TUBE FITTING PART #	GROUP #	A (mm)	D (mm)	E (mm)
APDA0X	0	30	—	61
APDA1X	1	35	20	69
APDA2X	2	43	26	86
APDA3X	3	52	33	104
APDA4X	4	60	40	117
APDA5X	5	75	52	145
APDA6X	6	90	66	176

Thickness 3 mm

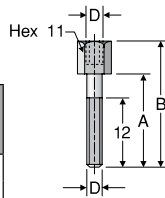


Dimensions and pressures for reference only, subject to change.

ASA

Stacking Bolts

TUBE FITTING PART #	GROUP #	A (mm)	B (mm)	D (mm)
ASA0X	0,1	20	34	M6 x 1
ASA2X	2	25	39	M6 x 1
ASA3X	3	30	44	M6 x 1
ASA4X	4	35	49	M6 x 1
ASA5X	5	50	64	M6 x 1
ASA6X	6	60	74	M6 x 1



APRA

Weld Plate – Strip

TUBE FITTING PART #	GROUP #	D (mm)	A (mm)	E (mm)	NUMBER OF CLAMPS
APRA0X	0	—	30	298	10
APRA1X	1	20	35	349	10
APRA2X	2	26	43	427	10
APRA3X	3	33	52	516	10
APRA4X	4	40	60	297	5
APRA5X	5	52	75	370	5
APRA6X	6	66	90	446	5

Thickness 3 mm

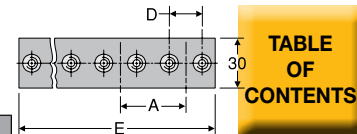


TABLE OF CONTENTS

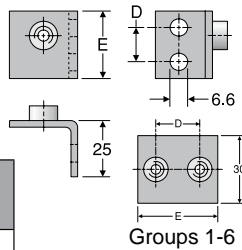
VISUAL INDEX

APWA

Weld Plate – Angled

TUBE FITTING PART #	GROUP #	D (mm)	E (mm)
APWA0X	0	14	30
APWA1X	1	20	36
APWA2X	2	26	42
APWA3X	3	33	50
APWA4X	4	40	59
APWA5X	5	52	72
APWA6X	6	66	88

Thickness 3 mm

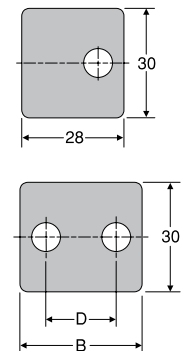


DPA

Top Plate

TUBE FITTING PART #	GROUP #	B (mm)	D (mm)
DPA0X	0	0	—
DPA1X	1	34	20
DPA2X	2	40	26
DPA3X	3	48	33
DPA4X	4	57	40
DPA5X	5	70	52
DPA6X	6	86	66

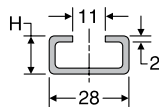
Thickness 3 mm



TS

Mounting Rail

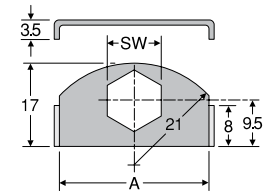
TUBE FITTING PART #	GROUP #	H (mm)	LENGTH (meter)
TS11A/B1X	ALL	11	1
TS14A/B1X	ALL	14	1
TS30A/B1X	ALL	30	1
TS11A/B2X	ALL	11	2
TS14A/B2X	ALL	14	2
TS30A/B2X	ALL	30	2



SBA

Locking Plate

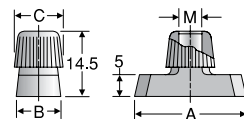
TUBE FITTING PART #	GROUP #	A (mm)	SW (mm)
SBAX	ALL	30	11



TMA

Lock Nut

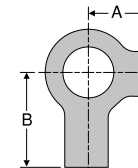
TUBE FITTING PART #	GROUP #	A (mm)	B (mm)	C (mm)	M (mm)
TMA/TMB1VERZX	ALL	25.4	10.4	12	M6 X 1



USA

Locking Washer

TUBE FITTING PART #	GROUP #	A (mm)	B (mm)
USA/USB1X	ALL	9	18

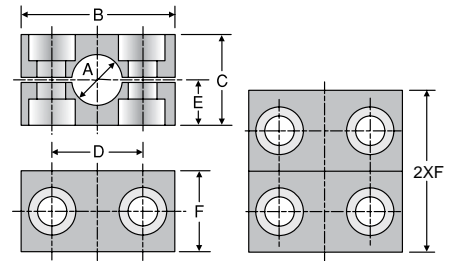


Dimensions and pressures for reference only, subject to change.

RCP / RCN / RCA / RCPG

Clamp Halves

TUBE FITTING PART #	GROUP #	A Metric Tube Size	A Inch Pipe Size	A Inch Tube Size	B (mm)	C (mm)	D (mm)	E (mm)	F (mm)
RCP108X		8		5/16					
RCP110X		10	1/8						
RCP112X		12							
RCP113.5X	1	13.5	1/4						
RCP114X		14			55	32	33	16	30
RCP115X		15							
RCP116X		16		5/8					
RCP117.2X		17.2	3/8						
RCP118X		18							
RCP220X		20							
RCP221.3X		21.3	1/2						
RCP222X		22							
RCP223X	2	23			70	48	45	24	30
RCP225X		25		1					
RCP226.9X		26.9	3/4						
RCP228X		28							
RCP330X		30							
RCP332X		32		1 1/4					
RCP333.7X		33.7	1						
RCP335X	3	35			85	60	60	30	30
RCP338X		38		1 1/2					
RCP340X		40							
RCP342X		42	1 1/4						
RCP438X		38		1 1/2					
RCP440X		40							
RCP442X		42	1 1/4						
RCP445X		45							
RCP448.3X	4	48.3	1 1/2						
RCP450X		50			115	90	90	45	45
RCP451X		51		2					
RCP452X		52							
RCP455X		55							
RCP457X		57		2 1/4					
RCP460.3X		60.3	2						
RCP463X		63		2 1/2					
RCP465X		65							
RCP470X		70							
RCP570X		70							
RCP576.1X		76.1	2 1/2	3					
RCP580X	5	80			152	120	122	60	60
RCP582.5X		82.5		3 1/4					
RCP588.9X		88.9	3	3 1/2					
RCP690X		90							
RCP6101.6X	6	101.6	3 1/2	4					
RCP6108X		108		4 1/4	205	170	168	85	80
RCP6114.3X		114.3	4	4 1/2					
RCP6127X		127		5					
RCP7127X		127		5					
RCP7133X		133		5 1/4					
RCP7140X		140	5	5 1/2					
RCP7152.4X	7	152.4	5 1/2	6	250	200	205	100	90
RCP7159X		159		6 1/4					
RCP7165.1X		165.1	6	6 1/2					
RCP7168.3X		168.3		6 5/8					
RCP8168.3X	8	168.3		6 5/8					
RCP8177.8X		177.8		7	320	270	265	135	120
RCP8193.7X		193.7		7 5/8					
RCP8219.1X		219.1	8	8 5/8					



RCP

RCPD
(2 pairs of RCP)

Material codes for clamp halves:
 Polypropylene - RCP
 inside plain - RCPG (for hose)
 Polyamide 6 - RCN
 Aluminum - RCA

TABLE OF CONTENTS

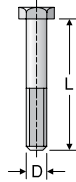
VISUAL INDEX

P

Dimensions and pressures for reference only, subject to change.

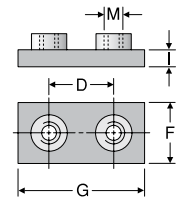


SSC
 Hex Head Bolts



TUBE FITTING PART #	GROUP #	D (mm)	L (mm)
SSC1X	1	M10 x 1.5	45
SSC2X	2	M10 x 1.5	60
SSC3X	3	M10 x 1.5	70
SSC4X	4	M12 x 1.5	100
SSC5X	5	M16 x 2	130
SSC6X	6	M20 x 2	190
SSC7X	7	M24 x 2	220
SSC8X	8	M30 x 2	300

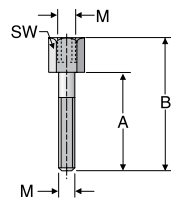
APC
 Weld Plate



TUBE FITTING PART #	GROUP #	D (mm)	F (mm)	G (mm)	I (mm)	M (mm)
APC1X	1	33	30	73	8	M10 x 1.5
APC2X	2	45	30	85	8	M10 x 1.5
APC3X	3	60	30	100	8	M10 x 1.5
APC4X	4	90	45	140	10	M12 x 1.5
APC5X	5	122	60	180	10	M16 x 2
APC6X	6	168	80	225	15	M20 x 2
APC7X	7	205	90	270	15	M24 x 2
APC8X	8	265	120	340	25	M30 x 2

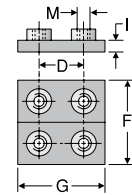
TABLE OF CONTENTS
 VISUAL INDEX

ASC
 Stacking Bolts



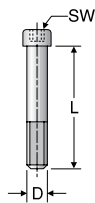
TUBE FITTING PART #	GROUP #	M (mm)	SW (mm)	A (mm)	B (mm)
ASC1X	1	M10 x 1.5	15	25	51
ASC2X	2	M10 x 1.5	15	40	66
ASC3X	3	M10 x 1.5	15	50	76
ASC4X	4	M12 x 1.5	17	85	112
ASC5X	5	M16 x 2	21	110	146
ASC6X	6	M20 x 2	27	155	206
ASC7X	7	M24 x 2	30	185	245
ASC8X	8	M30 x 2	36	250	330

APDC
 Double Weld Plate



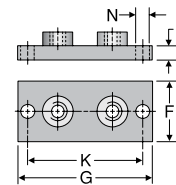
TUBE FITTING PART #	GROUP #	D (mm)	F (mm)	G (mm)	I (mm)	M (mm)
APDC1X	1	33	60	73	8	M10 x 1.5
APDC2X	2	45	60	85	8	M10 x 1.5
APDC3X	3	60	60	100	8	M10 x 1.5
APDC4X	4	90	90	140	10	M12 x 1.5
APDC5X	5	122	120	180	10	M16 x 2
APDC6X	6	168	160	225	15	M20 x 2
APDC7X	7	205	180	270	15	M24 x 2
APDC8X	8	265	240	340	25	M30 x 2

ISC
 Cap Screws



TUBE FITTING PART #	GROUP #	D (mm)	L (mm)	SW (mm)
ISC1X	1	M10 x 1.5	45	8
ISC2X	2	M10 x 1.5	60	8
ISC3X	3	M10 x 1.5	70	8
ISC4X	4	M12 x 1.5	100	10
ISC5X	5	M16 x 2	130	14
ISC6X	6	M20 x 2	190	17
ISC7X	7	M24 x 2	220	19
ISC8X	8	M30 x 2	300	22

APLC
 Weld / Screw Plate



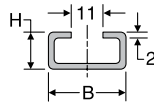
TUBE FITTING PART #	GROUP #	F (mm)	G (mm)	I (mm)	K (mm)	N (mm)
APLC1X	1	30	113	8	85	11
APLC2X	2	30	125	8	97	11
APLC3X	3	30	140	8	112	11
APLC4X	4	45	190	10	160	14
APLC5X	5	60	240	10	205	18
APLC6X	6	80	310	15	270	22
APLC7X	7	90	370	15	320	26
APLC8X	8	120	450	25	390	33

Dimensions and pressures for reference only, subject to change.



TSC

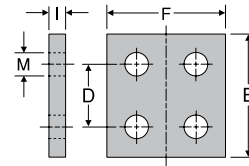
Mounting Rail



TUBE FITTING PART #	GROUP #	B (mm)	H (mm)	LENGTH (meter)
TSC1X	ALL	40	22	1
TSC2X	ALL	40	22	2

DPDC

Double Top Plate



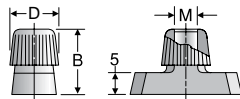
TUBE FITTING PART #	GROUP #	B (mm)	D (mm)	F (mm)	I (mm)	M (mm)
DPDC1X	1	55	33	60	8	11
DPDC2X	2	70	45	60	8	11
DPDC3X	3	85	60	60	8	11
DPDC4X	4	115	90	90	10	14
DPDC5X	5	152	122	120	10	18
DPDC6X	6	205	168	160	15	22
DPDC7X	7	250	205	180	15	26
DPDC8X	8	320	265	240	25	33

TABLE OF CONTENTS

VISUAL INDEX

TMC

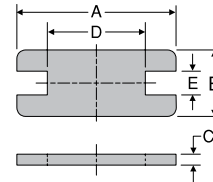
Lock Nut



TUBE FITTING PART #	GROUP #	B (mm)	D (mm)	M (mm)
TMC1X	1-3	20	17.8	M10 x 1.5
TMC4X	4	23	19.8	M12 x 1.5

SPC

Locking Plate

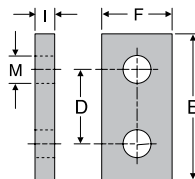


TUBE FITTING PART #	GROUP #	A (mm)	B (mm)	C (mm)	D (mm)	E (mm)
SPC1X	1	55	30	8	14	15.5
SPC2X	2	70	30	8	26	15.5
SPC3X	3	85	30	8	41	15.5
SPC4X	4	115	45	10	69	17.5
SPC5X	5	152	60	10	97	21.5
SPC6X	6	205	80	15	137	27.5
SPC7X	7	250	90	15	169	30.5
SPC8X	8	320	120	25	219	36.5

P

DPC

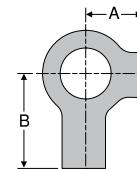
Top Plate



TUBE FITTING PART #	GROUP #	B (mm)	D (mm)	F (mm)	I (mm)	M (mm)
DPC1X	1	55	33	30	8	11
DPC2X	2	70	45	30	8	11
DPC3X	3	85	60	30	8	11
DPC4X	4	115	90	45	10	14
DPC5X	5	152	122	60	10	18
DPC6X	6	205	168	80	15	22
DPC7X	7	250	205	90	15	26
DPC8X	8	320	265	120	25	33

USC

Locking Washer



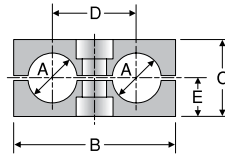
TUBE FITTING PART #	GROUP #	A (mm)	B (mm)
USC1X	1,2,3	13	22
USC4X	4	15	28
USC5X	5	18	32
USC6X	6	21	36
USC7X	7	25	42
USC8X	8	32	52

Dimensions and pressures for reference only, subject to change.

RBP / RBN

Clamp Halves

TUBE FITTING PART #	GROUP #	A Metric Tube Size	A Inch Pipe Size	A Inch Tube Size	B (mm)	C (mm)	D (mm)	E (mm)
RBP106X	1	6						
RBP106.4X		6.4		1/4				
RBP108X		8		5/16	36	27	20	13.5
RBP109.5X		9.5	1/8	3/8				
RBP110X		10						
RBP112X		12						
RBP212.7X	2	12.7		1/2				
RBP213.5X		13.5	1/4					
RBP214X		14						
RBP215X		15		5/8	53	26	29	13
RBP216X		16						
RBP217.2X	17.2	3/8						
RBP218X		18						
RBP319X	3	19		3/4				
RBP320X		20						
RBP321.3X		21.3	1/2		67	37	36	18.5
RBP322X		22						
RBP325X		25		1				
RBP426.9X	4	26.9	3/4					
RBP428X		28			82	42	45	21
RBP430X		30						
RBP532X	5	32		1 1/4				
RBP533.7X		33.7	1					
RBP535X		35			106	54	56	27
RBP538X		38		1 1/2				
RBP542X		42	1 1/4					



Material codes for clamp halves:
 Polypropylene - RBP
 inside plain - RBPG (for hose)
 Polyamide 6 - RBN
 Width 30 mm

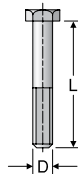
TABLE OF CONTENTS

VISUAL INDEX

SSB

Hex Head Bolt

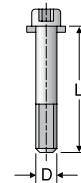
TUBE FITTING PART #	GROUP #	D (mm)	L (mm)	MATERIAL
SSLA2/SSB1X	1	M6 x 1	35	•
SSB2X	2	M8 x 1	35	•
SSB3X	3	M8 x 1	45	•
SSB4X	4	M8 x 1	50	•
SSB5X	5	M8 x 1	60	•



ISB

Cap Screws

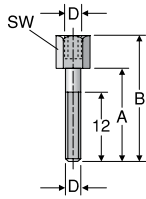
TUBE FITTING PART #	GROUP #	D (mm)	L (mm)	MATERIAL
ISB1X	1	M6 x 1	35	•
ISB2X	2	M8 x 1	35	•
ISB3X	3	M8 x 1	45	•
ISB4X	4	M8 x 1	50	•
ISB5X	5	M8 x 1	60	•



Dimensions and pressures for reference only, subject to change.

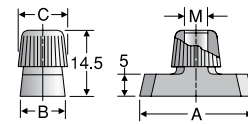
ASB
 Stacking Bolts

TUBE FITTING PART #	GROUP #	D (mm)	A (mm)	B (mm)	SW (mm)
ASB1X	1	M6 x 1	20	34	11
ASB2X	2	M8 x 1	20	33	12
ASB3X	3	M8 x 1	29	44	12
ASB4X	4	M8 x 1	34	49	12
ASB5X	5	M8 x 1	47	62	12



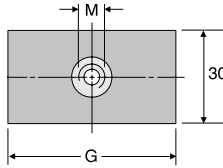
TMB
 Lock Nut

TUBE FITTING PART #	GROUP #	A (mm)	B (mm)	C (mm)	M (mm)
TMA/TMB1VERZX	1	25.4	10.4	12	M6 x 1
TMB2X	2-5	25.4	10.4	12	M8 x 1



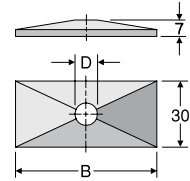
APB
 Weld Plate

THICKNESS	TUBE FITTING PART #	GROUP #	G (mm)	M (mm)
3	APB1X	1	37	M6 x 1
5	APB2X	2	55	M8 x 1
5	APB3X	3	70	M8 x 1
5	APB4X	4	85	M8 x 1
5	APB5X	5	110	M8 x 1



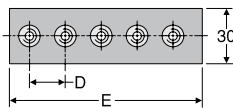
DPB
 Top Plate

TUBE FITTING PART #	GROUP #	B (mm)	D (mm)
DPB1X	1	34	6.6
DPB2X	2	51	8.6
DPB3X	3	64	8.6
DPB4X	4	78	8.6
DPB5X	5	102	8.6



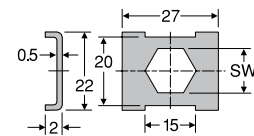
APRB
 Weld Plate – Strip

THICKNESS	TUBE FITTING PART #	GROUP #	D (mm)	E (mm)
3	APRB1X	1	40	196
5	APRB2X	2	58	288
5	APRB3X	3	72	358
5	APRB4X	4	90	446
5	APRB5X	5	112	558



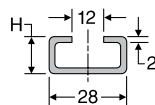
SBB
 Locking Plate

TUBE FITTING PART #	GROUP #	SW (mm)
SBB1X	1	11
SBB2X	2-5	12



TS
 Mounting Rail

TUBE FITTING PART #	GROUP #	B (mm)	H (mm)	LENGTH (meter)
TS11A/B1X	ALL	28	11	1
TS14A/B1X	ALL	28	14	1
TS30A/B1X	ALL	28	30	1
TS11A/B2X	ALL	28	11	2
TS14A/B2X	ALL	28	14	2
TS30A/B2X	ALL	28	30	2



US
 Locking Washer

TUBE FITTING PART #	GROUP #	A (mm)	B (mm)
USA/USB1X	1	9	18
USB2X	2-5	11	20

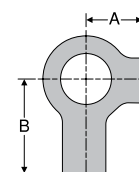


TABLE OF CONTENTS

VISUAL INDEX

P

Dimensions and pressures for reference only, subject to change.



**TABLE
OF
CONTENTS**

**VISUAL
INDEX**



TABLE
OF
CONTENTS

Metric Tube

Q



ENGINEERING YOUR SUCCESS.

Introduction

Parker offers three types of seamless metric tubes for hydraulic, pneumatic and instrumentation applications:

- Steel seamless cold drawn tube, phosphate and oil dipped for corrosion resistance
- Steel seamless cold drawn tube, zinc Chromium-6 free plating for corrosion resistance
- Stainless steel cold drawn tube

Conformance and Material Specifications

Tests and Certificates

All tubes are subjected to a non-destructive leak test and marked accordingly. This marking is used in lieu of a works certificate DIN EN 10204-2.2. Test Class 1 DIN EN 10216-5 Table 7 applies for tubes made of 1.4571 material.

Materials and Mechanical Properties

Steel Types, mechanical properties and conditions are listed in Table Q1.

Welding Suitability and Weldability:

- Steel tubes of St. 37.4, R Series, are weldable according to usual techniques.
- Not recommended to weld St. 37.4, R-CF series, Zinc Chromium-6 Free plated tubes.

Stainless steel tubes of 1.4571 are suitable for arc welding. The welding filler should be selected in accordance with DIN EN1600 and DIN EN12072 Part 1 taking into account the type of application and the welding technique.

Assembly and Installation

Please refer to Section S for the assembly and installation instructions for Metric Tube fittings.

Applications

Recommended Bend Radius

A bend radius of 3 times the tube O.D. or greater is recommended for cold bending of Parker tubes with hand, mechanical and power bending equipment.

*Use of Tube Supports

The use of VH tube supports for EO and EO-2 fittings is required in certain thinner wall tubes to ensure proper assembly. Consult Fig. S45 & Fig. S46 on page S30.

Temperature Range

- Parker steel (St. 37.4) metric seamless tube can be used at the full rated working pressures without pressure rating reductions within the following temperature range: -40°C to +120°C. Maximum allowable operating temperature of +250°C.
- Parker stainless steel (1.4571) metric seamless tube can be used at full rated working pressures with-out pressure reductions within the following temperature ranges: -60°C to +20°C. Maximum allowable operating temperature of +400°C. Elevated temperature pressure reductions are as listed in Table Q2.

As Delivered Conditions:

Standard Tube Lengths: 6 meters (approx. 20 ft)

Surface Finish:

- Steel (St. 37.4): Phosphated and oiled
 - I.D. dimensions 1.5 – 5 mm, outside and inside oiled
 - I.D. dimensions 6 mm and higher, outside and inside phosphated and oiled
- Steel (St. 37.4) R-CF Series: Zinc Chromium-6 Free

Parker Series	Material	Tensile Strength	Yield Strength	% Elongation	Condition
R Series	Steel, fine grain E235N acc. to EN10305-4 (St. 37.4 acc. to DIN1630	340 N/mm ² min. 49,000 PSI	235 N/mm ² min. 34,000 PSI	25% min.	Seamless, cold drawn normal annealed, DIN EN 10305-1 and -4
R-71 Series	Stainless steel, 1.4571 X6CrNiMoTi17122	500 N/mm ² min. 72,500 PSI	245 N/mm ² min. 35,500 PSI	35% min.	Seamless, cold drawn free of scale, heat treated in accordance with DIN EN 10216-5 tab. 6

Table Q1 — Parker Steel tubes mechanical properties and conditions

Temperature	Material	-60° up to +20° C	50° C	100° C	200° C	300° C	400° C
Pressure reductions in %	1.4571	—	5.5	11.5	21.5	29	34

Note: Interpolation is acceptable for intermediate temperature levels.

Table Q2 — Parker stainless tube elevated temperature derating factors

Seamless EO Steel Tubes Material E235N (St. 37.4)

Tolerances DIN EN 10305-4



Order code		Tube O.D. (mm)	Tolerance	Wall thickness (mm)	Tube I.D. (mm)	Design pressure bar		Burst pressure bar	Weight kg/m	
Phosphated and oiled	Cr(VI)-free					DIN 2413 I Static	DIN 2413 III Dynamic			
R04X0.5	R04X0.5CF	4		0.50	3.0	313	273	1160	0.047	
R04X1	R04X0.75CF	4	±0.08	0.75	2.5	470	391	1820	0.063	
	R04X1CF	4		1.00	2.0	627	500	2700	0.074	
R06X1	R05X1CF	5	±0.08	1.00	3.0	501	416	2120	0.099	
	R06X0.75CF	6		0.75	4.5	333	288	1150	0.103	
	R06X1CF	6		1.00	4.0	444	372	1650	0.123	
R06X1.5	R06X1.5CF	6	±0.08	1.50	3.0	666	526	2550	0.166	
	R06X2CF	6		2.00	2.0	692	662	>3500	0.197	
	R06X2.25CF	6		2.25	1.5	757	725	>3500	0.208	
R08X1	R08X1CF	8		1.00	6.0	333	288	1175	0.173	
R08X1.5	R08X1.5CF	8	±0.08	1.50	5.0	499	412	1925	0.240	
R08X2	R08X2CF	8		2.00	4.0	666	526	2500	0.296	
	R08X2.5CF	8		2.50	3.0	658	630	2650	0.339	
R10X1	R10X1CF	10		1.00	8.0	282	248	900	0.222	
R10X1.5	R10X1.5CF	10		1.50	7.0	423	357	1450	0.314	
R10X2	R10X2CF	10	±0.08	2.00	6.0	564	458	2025	0.395	
	R10X2.5CF	10		2.50	5.0	705	551	2675	0.462	
	R10X3CF	10		3.00	4.0	666	638	>3500	0.518	
R12X1	R12X1CF	12		1.00	10.0	235	209	750	0.271	
R12X1.5	R12X1.5CF	12		1.50	9.0	353	303	1150	0.388	
R12X2	R12X2CF	12	±0.08	2.00	8.0	470	391	1600	0.493	
	R12X2.5CF	12		2.50	7.0	588	474	2025	0.586	
	R12X3CF	12		3.00	6.0	705	551	2600	0.666	
R14X2	R12X3.5CF	12		3.50	5.0	651	624	2600	0.734	
	R14X1.5CF	14		1.50	11.0	302	264	975	0.462	
	R14X2CF	14	±0.08	2.00	10.0	403	342	1325	0.592	
R14X3	R14X2.5CF	14		2.50	9.0	504	415	1650	0.709	
	R14X3CF	14		3.00	8.0	604	485	2200	0.814	
R15X1	R15X1CF	15		1.00	13.0	188	170	575	0.345	
	R15X1.5CF	15		1.50	12.0	282	248	950	0.499	
	R15X2	R15X2CF	15	±0.08	2.00	11.0	376	321	1275	0.641
R16X1.5	R16X1.5CF	16		3.00	9.0	564	458	2000	0.888	
	R16X2	R16X1.5CF	16	±0.08	1.50	13.0	264	233	850	0.536
	R16X2.5	R16X2CF	16		2.00	12.0	353	303	1175	0.691
R16X3	R16X2.5CF	16		2.50	11.0	441	370	1500	0.832	
	R16X3CF	16		3.00	10.0	529	433	1850	0.962	
R18X1	R18X1CF	18		1.00	16.0	157	143	450	0.419	
R18X1.5	R18X1.5CF	18		1.50	15.0	235	209	700	0.610	
R18X2	R18X2CF	18	±0.08	2.00	14.0	313	273	975	0.789	
	R18X2.5	R18X2.5CF	18		2.50	13.0	392	333	1300	0.956
	R18X3CF	18		3.00	12.0	470	391	1575	1.111	

Table Q3 — Seamless EO steel tubes

Pressure Calculations:

Calculation pressures given are according to DIN 2413 Part 1 for **static stress**

$$P = \frac{20 \cdot K \cdot s \cdot c}{S \cdot da} \text{ (bar)}$$

Material characteristic value K=235 N/mm²

and

DIN 2413 part III for **dynamic stress**

$$P = \frac{20 \cdot K \cdot s \cdot c}{S \cdot (da + s \cdot c)} \text{ (bar)}$$

Material characteristic value K=226 N/mm² (permanent fatigue strength)

Design correction value S=1.5 for static and dynamic stress.

Factor "c" for consideration of wall thickness **divergence for static and dynamic stress** =0.8 for tube o.d. 4 and 5; 0.85 for tube o.d. 6 and 8; 0.9 for larger tube o.d.

da = Tube O.D. in mm

s = Wall thickness in mm

Standard Tube Length:

- 6 m (19.7 ft.)

Conversion Factors:

- Bar x 14.5 = psig
- kg/m x 0.672 = lbs/ft
- N/mm² x 145 = lb/in²

See Remarks on page Q5.

Dimensions and pressures for reference only, subject to change.





Seamless EO Steel Tubes Material E235N (St. 37.4) (continued)

Tolerances DIN EN 10305-4

Order code		Tube O.D. (mm)	Tolerance	Wall thickness (mm)	Tube I.D. (mm)	Design pressure bar		Burst pressure bar	Weight kg/m
Phosphated and oiled	Cr(VI)-free					DIN 2413 I Static	DIN 2413 III Dynamic		
R20X2	R20X1.5CF	20	±0.08	1.50	17.0	212	190	675	0.684
	R20X2CF	20		2.00	16.0	282	248	900	0.888
R20X2.5	R20X2.5CF	20	±0.08	2.50	15.0	353	303	1100	1.079
	R20X3	20		3.00	14.0	423	357	1400	1.258
R20X3	R20X3CF	20	±0.08	3.50	13.0	494	408	1650	1.424
	R20X3.5CF	20		4.00	12.0	564	458	2000	1.578
	R22X1.5	22		1.50	19.0	192	173	550	0.758
R22X2	R22X2CF	22	±0.08	2.00	18.0	256	227	775	0.986
R22X2.5	R22X2.5CF	22		2.50	17.0	320	278	1025	1.202
	R22X3CF	22		3.00	16.0	385	328	1175	1.406
R25X2	R25X2CF	25	±0.08	2.00	21.0	226	201	725	1.134
R25X2.5	R25X2.5CF	25		2.50	20.0	282	248	850	1.387
	R25X3	25		3.00	19.0	338	292	1025	1.628
R25X4	R25X4CF	25	±0.08	4.00	17.0	451	378	1500	2.072
R25X4.5	R25X4.5CF	25		4.50	16.0	508	418	1625	2.275
	R28X1.5	R28X1.5CF		28	1.50	25.0	151	138	425
R28X2	R28X2CF	28	±0.08	2.00	24.0	201	181	600	1.282
R28X2.5	R28X2.5CF	28		2.50	23.0	252	223	750	1.572
	R28X3	R28X3CF		28	3.00	22.0	302	264	900
R30X2.5	R30X2CF	30	±0.08	2.00	26.0	188	170	575	1.381
	R30X2.5CF	30		2.50	25.0	235	209	725	1.695
R30X3	R30X3CF	30		3.00	24.0	282	248	850	1.998
R30X4	R30X4CF	30	±0.08	4.00	22.0	376	321	1175	2.565
R30X5	R30X5CF	30		5.00	20.0	470	391	1600	3.083
	R35X2	R35X2CF		35	±0.15	2.00	31.0	161	147
R35X2.5	R35X2.5CF	35	±0.15	2.50	30.0	201	181	600	2.004
	R35X3	35		3.00	29.0	242	215	700	2.367
R35X3	R35X3CF	35		4.00	27.0	322	280	960	3.058
	R38X2.5CF	38	2.50	33.0	186	168	550	2.189	
	R38X3	R38X3CF	38	3.00	32.0	223	199	675	2.589
R38X4	R38X4CF	38	±0.15	4.00	30.0	297	260	900	3.354
R38X5	R38X5CF	38		5.00	28.0	371	318	1150	4.069
	R38X6CF	38		6.00	26.0	445	373	1425	4.735
R42X2	R42X2CF	42	±0.2	2.00	38.0	134	123	375	1.973
	R42X3	42		3.00	36.0	201	181	575	2.885
R42X4	R42X4CF	42		4.00	34.0	269	237	850	3.749
R50X6		50	±0.2	6.00	38.0	338	292		6.511
R65X8		65		±0.3	8.00	49.0	347	299	

Table Q3 — Seamless EO steel tubes (cont'd.)

Remarks:

Corrosion — Additional allowances are not considered for the calculation of pressures

$$\frac{da \text{ (bar)}}{\text{dimax.}} > 2$$

are calculated for static stress in accordance with DIN 2413 Part III, but with K = 235 N/mm²

When a specific design factor is required, calculations should be based upon the burst pressures shown in the above tables.

Temperature range: -40°C up to 120°C without pressure reductions.

Surface finish:

Tubes with I.D. 1.5 to 5 mm: outside and inside oiled.

Tubes from 6 mm I.D. and above: outside and inside phosphated and oiled.

For increased temperatures:

control calculation according to DIN 2413 required (static application above 120°C).

$$P = \frac{20 \cdot K \cdot a \cdot c}{S \cdot (da + a \cdot c)} \text{ (bar)}$$

Material strength K for increased temperatures:

Temperature in °C	K (N/mm ²)
up to 200	185
up to 250	165

Dimensions and pressures for reference only, subject to change.



Seamless EO Stainless Steel Tubes Material-No.: 1.4571

Tolerances EN 10305-1 / DIN 2391

TABLE
OF
CONTENTS

Order code					1.4571 Design pressure bar DIN 2413 I Static	1.4571 burst pressure bar	Weight kg/m
1.4571	Tube O.D. (mm)	Tolerance	Wall thickness (mm)	Tube I.D. (mm)			
R04X171	4	±0.08	1.0	2	735		0.075
R06X171	6	±0.08	1.0	4	490	1850	0.125
R06X1.571	6	±0.08	1.5	3	735	2900	0.169
R08X171	8	±0.08	1.0	6	368	1300	0.175
R08X1.571	8		1.5	5	551	2050	0.244
R10X171	10		1.0	8	294	950	0.225
R10X1.571	10	±0.08	1.5	7	441	1750	0.319
R10X271	10		2.0	6	588	2400	0.401
R12X171	12		1.0	10	245	850	0.275
R12X1.571	12	±0.08	1.5	9	368	1400	0.394
R12X271	12		2.0	8	490	1900	0.501
R14X1.571	14		1.5	11	315	1200	0.469
R14X271	14	±0.08	2.0	10	420	1550	0.601
R14X2.571	14		2.5	9	525	2100	0.720
R15X171	15		1.0	13	196	675	0.351
R15X1.571	15	±0.08	1.5	12	294	1100	0.507
R15X271	15		2.0	11	392	1400	0.651
R16X1.571	16	±0.08	1.5	13	276	950	0.545
R16X271	16		2.0	12	368	1300	0.701
R16X2.571	16	±0.08	2.5	11	459	1850	0.845
R16X371	16		3.0	10	551	2400	0.977
R18X1.571	18	±0.08	1.5	15	245	800	0.620
R18X271	18		2.0	14	327	1150	0.801
R20X271	20		2.0	16	294	1050	0.901
R20X2.571	20	±0.08	2.5	15	368	1400	1.095
R20X371	20		3.0	14	441	1800	1.277
R22X1.571	22	±0.08	1.5	19	200	650	0.770
R22X271	22		2.0	18	267	900	1.002
R25X2.571	25	±0.08	2.5	20	294	1050	1.408
R25X371	25		3.0	19	353	1275	1.653
R28X1.571	28	±0.08	1.5	25	158	550	0.995
R28X271	28		2.0	24	210	700	1.302
R30X2.571	30	±0.08	2.5	25	245	850	1.722
R30X371	30	±0.08	3.0	24	294	1150	2.028
R30X471	30		4.0	22	392	1500	2.605
R35X271	35	±0.15	2.0	31	168	550	1.653
R38X471	38	±0.15	4.0	30	309	1150	3.405
R42X271	42	±0.2	2.0	38	140	475	2.003
R42X371	42		3.0	36	210	750	2.930

Table Q4 — Seamless EO stainless steel tubes

Pressure Calculation:

Pressure calculation given are according to DIN 2413 part I for **static stress**

$$P = \frac{20 \cdot K \cdot s \cdot c}{S \cdot da} \text{ (bar)}$$

Material characteristic value K=245 N/mm² (1.4571), K=245 N/mm² (1.4571) (1% proof stress)

Design factor S = 1.5

Factor "c" for consideration of wall thickness divergence: 0.9

da = Tube O.D. in mm

s = Wall thickness in mm

Remarks:

Corrosion — Additional allowances are not considered for the calculation of pressures.

Tubes with a diameter ratio da/di ≥ 1.35 are calculated according to DIN 2413 part III (formula see page Q5) with above characteristic K value.

Conversion Factors:

- Bar x 14.5 = psig
- kg/m x 0.672 = lbs/ft
- N/mm² x 145 = lb/in²

Dimensions and pressures for reference only, subject to change.





TABLE OF CONTENTS

VISUAL INDEX

Equipment

R

















ENGINEERING YOUR SUCCESS.

**TABLE
 OF
 CONTENTS**

 <p>Benders</p>	<p>Hand Tube Benders</p>  <p>R4-R5</p>	<p>Ratchet Hand Tube Bender</p>  <p>R4</p>	<p>1" Hand Tube Bender</p>  <p>R5</p>	<p>BAV06/12 Combined Tube Bending & Cutting Tool</p>  <p>R6</p>	<p>BV06/18, BV20/25 Tube Bending Tools</p>  <p>R6</p>
<p>Bender Capacity Guides</p> <p>R7</p>	<p>Exactol Benders 412 & 424</p>  <p>R8-R11</p>	<p>HB632 Hydraulic Bender</p>  <p>R12-R16</p>	<p>Mandrel Bending Components</p>  <p>R16-R18</p>	<p>CP432 Tube and Pipe Bender Kit</p>  <p>R19</p>	
 <p>Cutting & Deburring Tools</p>	<p>Kloskut Medium (Sizes 2 to 18)</p>  <p>R21</p>	<p>Kloskut Large (Sizes 12 to 32)</p>  <p>R21</p>	<p>Tru-Kut Sawing Vise (Sizes 3-32)</p>  <p>R21</p>	<p>Cut-Off Saw 974250</p>  <p>R21</p>	<p>In-Ex Deburring Tool (Sizes 2-26)</p>  <p>R22</p>
<p>Power Deburr Tool</p>  <p>R22</p>	 <p>Flanging Tools</p>	<p>Parflange 1025</p>  <p>R23</p>	<p>Flanging Pin and Die Sets</p>  <p>R23</p>	<p>Parflange ECO25</p>  <p>R25</p>	 <p>Flaring Tools</p>
<p>Vise Block and Flaring Pin (Sizes 4 to 24 and 6-38mm)</p>  <p>R27-R28</p>	<p>Rolo-Flair Rotary, Manual (Sizes 2 to 12)</p>  <p>R28</p>	<p>210A Combination Tool (Sizes 2 to 10)</p>  <p>R28</p>	<p>Hydra-Tool Hydraulic Flaring & Pre-Setting Tool</p>  <p>R29-R31</p>	<p>Karryflair</p>  <p>R32</p>	<p>Flaring Tooling for Parflange 1025</p>  <p>R33</p>
<p>Flaring Tooling for Parflange ECO25</p>  <p>R34</p>	 <p>Porting Tools</p>	<p>Straight Thread Port Tap (Sizes 2 to 32)</p>  <p>R35</p>	<p>SAE Straight Thread Port Counterbore (Sizes 2 to 32)</p>  <p>R35</p>	<p>BSPP Counterbores</p>  <p>R36</p>	<p>BSPP/BSPT Taps</p>  <p>R36</p>
<p>NPTF Taps</p>  <p>R37</p>	<p>ISO 6149-1 Port Tap</p>  <p>R37</p>	<p>ISO 6149-1 Port Counterbore</p>  <p>R38</p>	<p>ISO 6149-1 Port Counterbore with ID Groove</p>  <p>R38</p>	 <p>Pre-Setting Tools</p>	<p>Ferulset Ferrule Pre-Setter (Sizes 2 to 32)</p>  <p>R39</p>
<p>VOMO Pre-Assembly Bodies</p>  <p>R40</p>	<p>Hyferset Ferrule Pre-Setter (Sizes 4 to 32)</p>  <p>R41</p>	<p>Hydra-Tool</p>  <p>R44</p>	<p>Pre-Setting Tooling for Hydra-Tool</p>  <p>R44-R45</p>	<p>EO-Karrymat</p>  <p>R46</p>	

**TABLE
 OF
 CONTENTS**

<p>O-Ring Assembly Tools</p>	<p>O-Ring Pick</p>  <p>R48</p>	<p>Captive O-Ring Installation Tool</p>  <p>R48</p>	<p>Brazing Flux and Cleaner</p>	<p>Braze Flux</p>  <p>R49</p>	<p>Post Braze Cleaner</p>  <p>R49</p>
<p>Sealants, Lubricants, & Cleaners</p>	<p>LB 2000 & MPG-2</p>  <p>R50</p>	<p>EO Lubricants</p>  <p>R50</p>	<p>O-Lube</p>  <p>R50</p>	<p>Super O-Lube</p>  <p>R50</p>	<p>Threadmate</p>  <p>R51</p>
<p>Tube Preparation Centers</p>	<p>Modular Preparation Centers</p>  <p>R52</p>	<p>Thread Identification</p>	<p>Thread Identification Kit</p>  <p>R53</p>	<p>Portboards</p>  <p>R53</p>	<p>ITK International Thread Kit</p>  <p>R53</p>
<p>Wrenches</p>	<p>Par-Lok Wrenches</p>  <p>R54- R55</p>	<p>Weights</p>	<p>Tube Fabricating Equipment Weight Chart</p> <p>R56-R57</p>		

R

Hand Tube Benders – Inch

These are sturdy, easy-to-use hand tools for fast and accurate bending without kinks or visible flattening. Twelve individual sizes from -2 (1/8" O.D.) to -16 (1" O.D.) are available.

Medium Duty Inch Hand Tube Benders

Designed and built for fast, accurate bends and long service life.

These are individual benders for eight inch tube sizes (1/8", 3/16", 1/4", 5/16", 3/8", 1/2", 5/8", 3/4"). All of these benders will bend copper, aluminum, annealed steel and stainless steel. These can be used in hands or mounted in a bench vise.

HOW TO USE: Simply align marks of the pressure arm and radius block, then bend to the desired angle (up to 180°) by pulling steadily on the slide block handle. Bend angles are indicated on the radius block, both front and back. (Detailed instructions are included with each bender.) See the table below for technical data and part numbers.

Size	Tube O.D. (in.)	Radius to Tube Centerline (in.)	Min. Wall Without Flattening (in.)	Recommended Max. Wall Thickness		Part No.
				Copper, Aluminum (in.)	Steel, Stainless Steel (in.)	
3	3/16	5/8	0.020	Any	0.032.....	3-2829
4	1/4	5/8	0.028	Any	0.083.....	4-2829
5	5/16	15/16	0.032	Any	0.083.....	5-2829
6	3/8	15/16	0.032	Any	0.083.....	6-2829
8	1/2	1 1/2	0.042	Any	0.083.....	8-2829



Fig. R1 — Medium Duty Inch Hand Tube Bender

Ratchet Hand Tube Benders

These are individual benders for three tube sizes, 5/8", 3/4" and 7/8", in copper, aluminum, annealed steel and stainless steel. They can be used in hands or mounted in a bench vise.

HOW TO USE: Position the tube in the bender, close the latch and pull the ratchet handle away from radius block handle until the desired angle (up to 180°) is formed. Bend angles are indicated on the radius block. (Detailed instructions are included with each bender.) See the table below for technical data and part numbers.

Size	Tube O.D. (in.)	Radius to Tube Centerline (in.)	Min. Wall Without Flattening (in.)	Recommended Max. Wall Thickness		Part No.
				Copper, Aluminum (in.)	Steel, Stainless Steel (in.)	
10	5/8	3	0.042	Any	0.049.....	10-2829
12	3/4	3 3/4	0.049	Any	0.065.....	12-2829
14	7/8	3 3/4	0.049	Any	0.065.....	14-2829

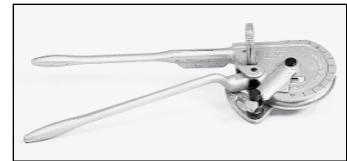


Fig. R2 — Ratchet Hand Tube Bender

Dimensions and pressures for reference only, subject to change.

1" Hand Tube Bender Part No. 16-2829

For 1" O.D. tube in soft copper and aluminum materials. This bender can be used in hands, but mounting in a bench vise is suggested, especially for heavier wall thickness tube.

HOW TO USE: Align marks and bend the tube to the desired angle (up to 180°) by pulling steadily on the operating handle. The handle may be re-positioned for maximum leverage. Bend angles are indicated on the radius block. (Detailed instructions are included with the bender.) See the table below for technical data and part numbers.

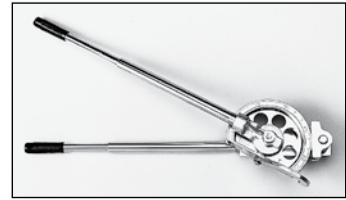


Fig. R3 — 1" Hand Tube Bender

Size	Tube O.D. (in.)	Radius to Tube Centerline (in.)	Min. Wall Without Flattening (in.)	Recommended Max. Wall Thickness		Part No.
				Copper, Aluminum (in.)	Steel, Stainless Steel (in.)	
16	1	3 1/2	0.065	Any	Not Recommended	16-2829

Hand Tube Benders – Metric

These are sturdy, easy-to-use hand tools for fast and accurate bending without kinks or visible flattening. Individual sizes in ten models from size 5mm to 25mm are available.

Medium Duty Metric Hand Tube Benders

Designed and built for fast, accurate bends and long service life.

These are individual benders for six metric tube sizes (5mm, 6mm, 8mm, 10mm, 12mm and 14mm). All of these benders will bend copper, aluminum, annealed steel and stainless steel. These can be used in hands or mounted in a bench vise.

HOW TO USE: Simply align the marks on the slide block and radius block, then bend to the desired angle (up to 180°) by pulling steadily on the slide block handle. Bend angles are indicated on the radius block, both front and back. (Detailed instructions are included with each bender.) See the table below for technical data and part numbers.



Fig. R4 — Medium Duty Metric Hand Tube Bender

Tube O.D. (mm)	Radius to Tube Centerline (mm)	Min. Tube Wall Thickness (mm)	Recommended Max. Wall Thickness		Part No.
			Copper, Aluminum (mm)	Steel, Stainless Steel (mm)	
6	16	1.0	Any	1.5.....	2829-6mm
8	24	1.0	Any	1.5.....	2829-8mm
10	24	1.0	Any	2.0.....	2829-10mm
12	38	1.0	Any	2.0.....	2829-12mm

R

Dimensions and pressures for reference only, subject to change.

TABLE
 OF
 CONTENTS

VISUAL
 INDEX

Bench Mount Metric Hand Bender and Cutting Guide

This bender combines a tube cutting guide with the bender for sizes 6mm, 8mm, 10mm, and 12mm. There are three bender rollers that cover all sizes. The bender mounts easily to a work bench or table.

Part Description Part No.
 Bench Mount Tube Bender (6mm, 8mm, 10mm, 12mm)..... **BAV06/12KPLX**



Fig. R5 — BAV06/12KPLX

Vise Mount Metric Hand Benders

Vise Mount Metric Bender – 6/18mm

This bender has six interchangeable rollers to cover tube sizes 6mm, 8mm, 10mm, 12mm, 14mm, 15mm, 16mm, and 18mm.

Part Description Part No.
 Vise Mount Tube Bender
 (6mm, 8mm, 10mm, 12mm, 14mm, 15mm, 16mm, 18mm) **BV06/18KPLX**



Fig. R6 — BV06/18KPLX

Tube O.D. (mm)	Bend Radius (mm)	Max. Wall Thickness (mm)
6	33	2.5
8	34	2.5
10	36	2.5
12	37	2.5
14	37	2.0
15	44	2.0
16	44	2.0
18	52	2.0

Vise Mount Metric Bender – 20/25mm

This bender has three interchangeable rollers to cover tube sizes 20mm, 22mm, and 25mm. All bend radii are 86.5mm. Pressure arm is not included with the BV20/25KPLX, however it can be manufactured on site with a piece of tube, or it can be ordered separately with part number BV20/2510X. Maximum wall thickness for all sizes is 2.0mm.

Part Description Part No.
 Vise Mount Tube Bender (20mm, 22mm, 25mm) **BV20/25KPLX**
 Pressure Arm **BV20/2510X**



Fig. R7 — BV20/25KPLX

Dimensions and pressures for reference only, subject to change.

Hand Crank & Hydraulic Tube Bender Capacity Guides

All benders listed in Tables S1 through S3 are capable of bending 1/2" O.D. and under fully annealed steel and stainless steel tube with no limit on wall thickness. For HARD copper and HIGH STRENGTH aluminum, use the wall thickness shown for stainless steel. Observe that VERY HARD materials may not be ductile enough to bend without fracture.

Inch Tube Sizes

Tube O.D.	Material	Tube Wall Thickness (in.)											
		0.035	0.049	0.058	0.065	0.072	0.083	0.095	0.109	0.120	0.134	0.156	0.188
3/4"	S	ABCD	ABCD	ABCD	ABCD	BCD	BCD	BCD	BCD	BCD	BCD	BCD	BCD
	SS	ABCD	ABCD	BCD	BCD	BCD	BCD	BCD	BCD	BCD	BCD	BCD	BCD
1"	S	BCD	BCD	BCD	BCD	BCD	BCD	BCD	BCD	BCD	BCD	BCD	BCD
	SS	BCD	BCD	BCD	BCD	BCD	BCD	BCD	BCD	BCD	BCD	BCD	BCD
1 1/4"	S	BCD	BCD	BCD	BCD	BCD	BCD	CD	CD	CD	CD	CD	CD
	SS	BCD	BCD	BCD	BCD	BCD	CD	CD	CD	CD	CD	C	C
1 1/2"	S	BCD	BCD	BCD	BCD	BCD	CD	CD	CD	CD	CD	CD	CD
	SS	BCD	BCD	CD	CD	CD	CD	CD	CD	CD	CD	C	C
2"	S	CD	CD	CD	CD	CD	CD	CD	CD	CD	CD	CD	CD
	SS	CD	CD	CD	CD	CD	CD	CD	CD	CD	CD	—	—

Table R1 — Hand Crank and Hydraulic Tube Benders Maximum Capacity Guide – Inch Sizes

Inch Pipe Sizes

Pipe Size	Material	Inch Pipe Schedule (IPS)	
		40	80
1/2"	S	CD	CD
	SS	CD	CD
3/4"	S	CD	CD
	SS	CD	CD
1"	S	CD	CD
	SS	CD	CD
1 1/4"	S	CD	CD
	SS	CD	CD
1 1/2"	S	CD	CD
	SS	CD	CD
2"	S	D	D
	SS	D	—

Table R2 — Hand Crank and Hydraulic Benders Maximum Capacity Guide – Inch Pipe Sizes

Metric Tube Sizes

Tube O.D. (mm)	Material	Tube Wall Thickness (mm)						
		1.5	2	2.5	3	3.5	4	5
18	S	ABCD	ABCD	ABCD	ABCD	BCD	BCD	CD
	SS	BCD	BCD	BCD	BCD	BCD	BCD	CD
20	S	ABCD	ABCD	ABCD	BCD	BCD	BCD	CD
	SS	BCD	BCD	BCD	BCD	BCD	BCD	CD
22	S	BCD	BCD	BCD	BCD	BCD	BCD	CD
	SS	BCD	BCD	BCD	BCD	BCD	BCD	CD
25	S	BCD	BCD	BCD	BCD	BCD	CD	CD
	SS	BCD	BCD	BCD	BCD	CD	CD	CD
28	S	BCD	BCD	BCD	BCD	CD	CD	CD
	SS	BCD	BCD	CD	CD	CD	CD	CD
30	S	BCD	BCD	BCD	BCD	CD	CD	CD
	SS	BCD	BCD	CD	CD	CD	CD	CD
32	S	BCD	BCD	CD	CD	CD	CD	CD
	SS	BCD	BCD	CD	CD	CD	CD	CD
35	S	BCD	CD	CD	CD	CD	CD	CD
	SS	BCD	CD	CD	CD	CD	CD	CD
38	S	BCD	CD	CD	CD	CD	CD	CD
	SS	CD	CD	CD	CD	CD	CD	CD
42	S	CD	CD	CD	CD	CD	CD	CD
	SS	CD	CD	CD	CD	CD	CD	—
50	S	CD	CD	CD	CD	CD	CD	—
	SS	CD	CD	CD	CD	CD	—	—

Table R3 — Hand Crank and Hydraulic Tube Benders Maximum Capacity Guide – Metric Tube Sizes

***Codes:**

- (A) Model 412 — Tube (1/4" thru 3/4" and 6mm thru 20mm) — Worm & Gear
- (B) Model 424 — Tube (1/4" thru 1 1/2" and 6mm thru 38mm) — Worm & Gear
- (C) Model HB632 — Tubeg (3/8" thru 2" and 10mm thru 50mm) — Hydraulic
- (D) Model CP432 — Tube (1/4" thru 2") — Hydraulic

Dimensions and pressures for reference only, subject to change.

Exactol® Crank-Operated Benders

Models 412/424

These portable benders are vise or bench mountable for easy action and fast accurate bending to 180°. Two models are available to bend tube sizes 4 (1/4") through 24 (1 1/2"). Exactol benders are designed with a worm-gear drive with a 60 to 1 gear ratio to allow accurate bending with minimum effort. They bend aluminum, copper, annealed steel and annealed stainless steel without kinks or wrinkles. Easy crank operation permits continuous production without excessive operator fatigue; for use in tube fabrication shops, in the field, or in factory maintenance departments.

A video (on DVD) is included to provide proper instructions for use.

Exactol® Model 412

The Exactol Model 412 will bend tube from size 4 (1/4") through size 12 (3/4") and 6mm through 20mm inclusive and is completely portable. Accessories include a sturdy metal carrying case, which accommodates the 412 bender, slide block, and selected radius blocks. See page R7 for wall thickness capabilities. May be held in a vise or bench mounted using the bench mounting adapter. Bulletin 4391-B400S and DVD are included with bender, which describe the operation in detail.

NOTE: The 412 must be bench mounted if mandrels are used.

COMPONENTS REQUIRED

The minimum components required are a Model 412 Bender with a slide block and a radius block which match the tube O.D. to be bent.

Part Name	Part No.
Exactol Model 412 Bender (for 1/4" through 3/4" O.D.).....	560569
Slide Block (for sizes 4-5-6-8-10-12)	550585
Slide Block (for sizes 6mm-8mm-12mm-12mm-14mm)	820091
Slide Block (for sizes 15mm-16mm-18mm-20mm).....	820092
Radius Blocks (for sizes 4-5-6-8-10-12 and 6mm thru 38mm) ...	See pages R10 – R11

OPTIONAL ACCESSORIES

Carrying Case (for bender, slide block and selected radius blocks)	550572
Bench Mounting Adapter	550570

Mandrel Bending Components

for 412 and 424 Benders See pages R16 – R18

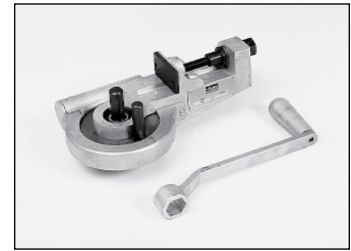


Fig. R8 — 412 Bender

TABLE
 OF
 CONTENTS

VISUAL
 INDEX



Fig. R9 — Slide Block

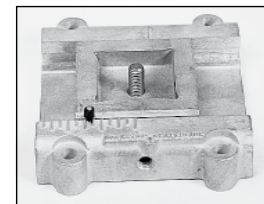


Fig. R10 — Bench Mount Adapter

Dimensions and pressures for reference only, subject to change.

Exactol® Model 412 Kit

This 412 kit contains all the basic tool requirements for bending tube from 1/4" through 3/4".

**Part No.
 412 KIT**

The following part numbers are included in the kit:

Part Name	Part No.
Exactol Model 412 Bender	560569
Carrying Case	550572
Slide Block for 1/4" through 3/4" tube	550585
Radius Block – 1/4" O.D. tube	550579
Radius Block – 3/8" O.D. tube.....	550581
Radius Block – 1/2" O.D. tube.....	550582
Radius Block – 5/8" O.D. tube.....	550583
Radius Block – 3/4" O.D. tube.....	550584

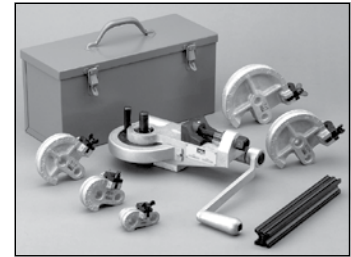


Fig. R11 — 412 Kit

**TABLE
 OF
 CONTENTS**

**VISUAL
 INDEX**

Exactol® Model 424

The Exactol Model 424 will bend tube from size 4 (1/4" O.D.) through size 24 (1 1/2" O.D.) and 6mm through 38mm inclusive. See page R7 for wall thickness capabilities. It is completely portable and may be vise or bench mounted. Bulletin 4391-B400S and video are included with the bender, which describe the operation in detail.

NOTE: The 424 must be bench mounted if mandrels are used.

A video (on DVD) is included to provide proper instructions for use.

COMPONENTS REQUIRED

The minimum components required are a Model 424 Bender with a slide block and a radius block that match the tube O.D. to be bent.

Part Name	Part No.
Exactol Model 424 bender (for 1/4" through 1 1/2" O.D.).....	621044
Slide Block (for sizes 4-5-6-8-10-12)	550585
Slide Block (for sizes 14-16-18-20).....	621045
Slide Block (for size 24)	870150
Slide Block (for sizes 6mm-8mm-10mm-12mm-14mm)	820091
Slide Block (for sizes 15mm-16mm-18mm-20mm).....	820092
Slide Block (for sizes 22mm-25mm-28mm-30mm).....	820093
Slide Block (for size 35mm)	820094
Slide Block (for size 38mm)	870150
Radius Blocks (for sizes -4 thru -24 and 6mm thru 38mm)	See pages R10 – R11

OPTIONAL ACCESSORIES

Bench Mounting Adapter.....	631156
Mandrel Bending Components for 412 and 424 Benders	See pages R16 – R18

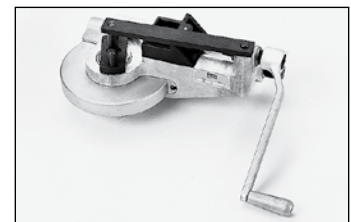


Fig. R12 — 424 Bender



Fig. R13 — Slide Block

R

Dimensions and pressures for reference only, subject to change.

Exactol® Model 424 Kit

Part No. 424 Kit

This 424 Kit contains all the basic tool requirements for bending tube from 1/4" through 1 1/2". The following part numbers are included in the kit:

Part Name	Part No.
Exactol Model 424 bender (for 1/4" through 1 1/2" O.D.).....	621044
Slide Block (for sizes 4-5-6-8-10-12)	550585
Slide Block (for sizes 14-16-18-20).....	621045
Slide Block (for size 24)*.....	870150
Radius Blocks – 1/4" O.D. Tube*	550579
Radius Block – 3/8" O.D. Tube	550581
Radius Block – 1/2" O.D. Tube	550582
Radius Block – 5/8" O.D. Tube	550583
Radius Block – 3/4" O.D. Tube	550584
Radius Block – 1" O.D. Tube	621047
Radius Block – 1 1/4" O.D. Tube	621049
Radius Block – 1 1/2" O.D. Tube*.....	870149

* Items not shown in the photo, but which are included in the 424 Kit.

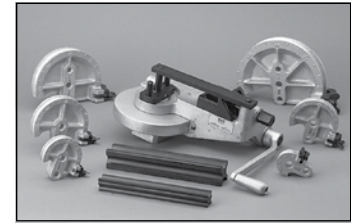


Fig. R15 — 424 Kit

TABLE
 OF
 CONTENTS

VISUAL
 INDEX

Radius Blocks

For use with Exactol Models 412/424 benders.

The 412 and 424 bender radius blocks have built in tube clamps, therefore separate clamp blocks are not required. The radius blocks are interchangeable within bender size ranges. Close bend radius blocks utilize the small bend radii, but also allow the bend to begin closer to the end connection.

412 and 424 Bender – Small Bend Radius Blocks

Size	Tube O.D. (in.)	Bend Radius (in.)	Part No.
4	1/4	9/16.....	550573
5	5/16	11/16.....	550574
6	3/8	15/16.....	550575
8	1/2	1 1/4.....	550576
10	5/8	1 1/2.....	550577
12	3/4	1 3/4.....	550578



Fig. R16 — Small Bend Radius Block

412 and 424 Bender – Large Bend Radius Blocks

Size	Tube O.D. (in.)	Bend Radius (in.)	Part No.
4	1/4	3/4.....	550579
5	5/16	1.....	550580
6	3/8	1 1/4.....	550581
8	1/2	2.....	550582
10	5/8	2 1/2.....	550583
12	3/4	3.....	550584
14	7/8	3 1/2.....	621046
16	1	4.....	621047
18	1 1/8	4 1/2.....	621048
20	1 1/4	5.....	621049
24	1 1/2	5.....	870149

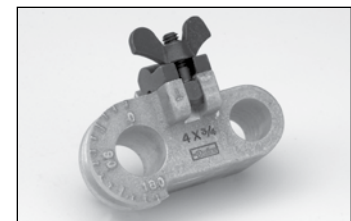


Fig. R17 — Large Bend Radius Block

Dimensions and pressures for reference only, subject to change.

412 and 424 Bender – Close Bend Radius Blocks

These adapters are used when bends are needed close to the end of the tube after the flare has been made, ferrule has been pre-set, or flange has been made. For flared or Ferulok fittings, attach tube end by threading tube nut onto the radius block threaded pin. To use this block with Seal-Lok fittings, Close Bend Adapters for Seal-Lok must be used to attach the tube to the radius block.

Size	Tube O.D. (in.)	Bend Radius (in.)	Part No.
8	1/2	1 1/4	590533
10	5/8	1 1/2	590535
12	3/4	1 3/4	590537

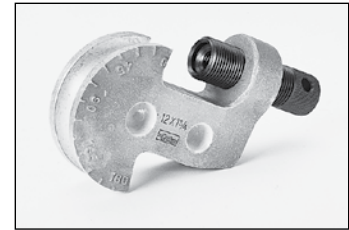


Fig. R18 — Close Bend Radius Block

Close Bend Adapters for Seal-Lok

These adapters are used when bends are needed close to the end of the tube after the flange has been made or the sleeve has been brazed onto the end of the tube.

HOW TO USE: Screw the Seal-Lok adapter into the internal thread* of the threaded pin on the radius block. Then attach the flanged or brazed tube by threading the tube nut to the Seal-Lok adapter on the radius block threaded pin.

* If the threaded pin does not have an internal thread, a new threaded pin is required.

Tube O.D. (in.)	Description	Part No.
1/2	Seal-Lok Adapter	930421-8
5/8	Seal-Lok Adapter	930421-10
3/4	Seal-Lok Adapter	930421-12
1/2	Threaded Pin (for Close Bend Radius Blocks)	930420-8
5/8	Threaded Pin (for Close Bend Radius Blocks)	930420-10
3/4	Threaded Pin (for Close Bend Radius Blocks)	930420-12



Fig. R19 — Seal-Lok Close Bend Adapter

412 and 424 Bender – Metric Radius Blocks

Tube O.D. (mm)	Bend Radius (mm)	Part No.
6	14	820090-6mm
8	18	820090-8mm
10	24	820090-10mm
12	32	820090-12mm
14	38	820090-14mm
15	38	820090-15mm
16	38	820090-16mm
18	44	820090-18mm
20	44	820090-20mm
22	89	820090-22mm
25	102	820090-25mm
28	102	820090-28mm
30	127	820090-30mm
32	127	820090-32mm
35	127	820090-35mm
38	127	870149 (same as 1-1/2" Radius Block)



Fig. R20 — Radius Block

R

Dimensions and pressures for reference only, subject to change.

Hydraulic Tube Bender Model HB632

Hydraulic power does the work in bending tube of all materials in sizes from 6 (3/8" O.D.) through size 32 (2" O.D.), 10mm through 50mm, with wall thicknesses as great as .188 for annealed steel, and pipe sizes from 3/8" through 1-1/2". See page R7 for wall thickness capabilities. The radius block, around which the tube is bent, is driven by a roller chain and sprocket powered by a cylinder and a separate hydraulic power unit.

Maximum bend angle is 180° with radii from 1 1/4" to 8". Close second bends can be performed in either direction. An adjustable stop controls the degree of bend to a maximum of 180° and is graduated in 1° increments. After the bend is completed and pressure is released, a spring returns the clamp arm to the zero starting position.

The clamp vise arm features a quick release speed screw for positioning the required clamp block. Each size of tube requires the proper sized radius block, clamp block and slide block.

Written instructions, a DVD and Bulletin 4391-B26 are included with each bender.

HB632 radius blocks, slide blocks and clamp blocks will work with the following benders as well: 624, 824, 832 and 848.

NOTE: For size 28 (1 3/4" O.D. tube) through 32 (2" O.D. tube) radius blocks, an adapter plate is required.

DIMENSIONS: L – 40" W – 11" H – 12"

COMPONENTS REQUIRED

Minimum components required are a Model HB632 Bender, hose assembly, hydraulic pump and a radius, slide and clamp block which match the tube/pipe O.D. to be bent.

Part Name	Part No.
Hydraulic Bender Model HB632 (without pump)	631050
Hydraulic Pump (10,000 psi, 110V AC)	900085
High Flow Hydraulic Pump (10,000 psi, 110V)	974691
Hose Assembly (3' long)	910004

One each of the following is required per tube O.D.:
Radius Block, Clamp Block, Slide Block.

Radius Block..... See pages R13 – R15

INCH TUBE SIZES

Clamp Block (for -6)	864266
Clamp Block (for -8, -12, -16, -24)	631092
Clamp Block (for -10, -14, -18, -20)	631093
Clamp Block (for -28)	027418-28
Clamp Block (for -32)	027418-32
Slide Block (for -6)	864276
Slide Block (for -8, -12, -16, -24)	520516
Slide Block (for -10, -14, -18, -20)	520518
Slide Block (for -28)	631063
Slide Block (for -32)	631066

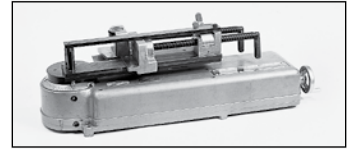


Fig. R21 — HB632



Fig. R22 — 900085 Pump



Fig. R23 — High Flow Pump



Fig. R24 — Clamp Block



Fig. R25 — Slide Block

Dimensions and pressures for reference only, subject to change.

METRIC TUBE SIZES	Part No.
Clamp Block (for 10mm, 12mm, 14mm, 16mm)	790017
Clamp Block (for 15mm, 16mm, 18mm, 20mm)	780195
Clamp Block (for 22mm, 25mm, 30mm, 32mm)	780196
Clamp Block (for 35mm)	974346
Clamp Block (for 38mm)	631092
Clamp Block (for 42mm)	974349
Clamp Block (for 50mm)	974352
Slide Block (for 10mm, 12mm, 14mm, 16mm)	790016
Slide Block (for 15mm, 16mm, 18mm, 20mm)	780192
Slide Block (for 22mm, 25mm, 30mm, 32mm)	780193
Slide Block (for 35mm)	820094
Slide Block (for 38mm)	520516
Slide Block (for 42mm)	974348
Slide Block (for 50mm)	974351

INCH PIPE SIZES	
Clamp Block (for 3/8", 1/2", 3/4")	974332
Clamp Block (for 1")	974338
Clamp Block (for 1 1/4")	974341
Clamp Block (for 1 1/2")	974343
Slide Block (for 3/8", 1/2", 3/4")	974331
Slide Block (for 1")	974336
Slide Block (for 1 1/4")	974340
Slide Block (for 1 1/2")	974342

OPTIONAL ACCESSORIES

Radius Block Adapter Plate
 (for sizes 1 3/4", 42mm, 1 1/2 IPS and larger)..... **660221**
 Mandrel Bending Components for HB632..... See pages R16 – R18
 A video (on DVD) is included to provide proper instructions for use.



Fig. R26 — Radius Block Adapter Plate

Radius Blocks

For use with HB632 Bender

Radius blocks for every standard tube size from size 6 (3/8" O.D.) to size 32 (2" O.D.), 10mm through 50mm, and inch pipe sizes 3/8" through 1-1/2" are available.

Standard Radius Blocks – Inch Sizes

Size	Tube O.D. (in.)	Radius (in.)	Part No.
6	3/8	1 1/8.....	590512-18
6	3/8	1 1/4.....	540502
8	1/2	1 1/4.....	530763
8	1/2	1 1/2.....	590515-24
10	5/8	1 1/2.....	530764
10	5/8	1 7/8.....	590518-30
12	3/4	1 3/4.....	530765
12	3/4	2 1/4.....	590521-36
14	7/8	2.....	530766
14	7/8	2 5/8.....	590523-42
16	1	3.....	590524-48
18	1 1/8	3 3/8.....	590526-54
18	1 1/8	3 1/2.....	530768
20	1 1/4	3 3/4.....	590527-60
24	1 1/2	4 1/2.....	590530-72
24	1 1/2	5.....	530770
28	1 3/4	7.....	631057-112*
32	2	8.....	631060-128*



Fig. R27 — Radius Block for use with HB632 Bender

R

* Requires the use of Radius Block Adapter Plate, Part No. 660221.

Dimensions and pressures for reference only, subject to change.



Radius Blocks – Metric Sizes

Tube O.D./ Size (mm)	Radius (mm)	Part No.
10	32	810023
12	32	780175
14	38	780176
15	38	780177
16	38	780178
18	44	780179
20	44	780180
22	89	780181
25	100	780182
30	128	780183
32	128	780184
35	105	974344
38	114	590530-72
42	128	974347*
50	150	974350*



Fig. R28 — Radius Block for use with HB632 Bender

TABLE
 OF
 CONTENTS

VISUAL
 INDEX

Radius Blocks – Inch Pipe Sizes

Inch Pipe Size (in.)	Bend Radius (in.)	Part No.
3/8	2 1/4	974325
1/2	2 5/8	974326
3/4	3 1/4	974327
1	4	974328
1 1/4	5	974329
1 1/2	6	974330*

* Requires the use of Radius Block Adapter Plate, Part No. 660221.

Dimensions and pressures for reference only, subject to change.

Close Bend Radius Blocks for HB632

These adapters are used when bends are needed close to the end of the tube after the flare has been made, ferrule has been pre-set, or flange has been made. For flared or Ferulok fittings, attach tube end by threading tube nut onto the radius block threaded pin. To use this block with Seal-Lok fittings, Close Bend Adapters for Seal-Lok must be used to attach the tube to the radius block.

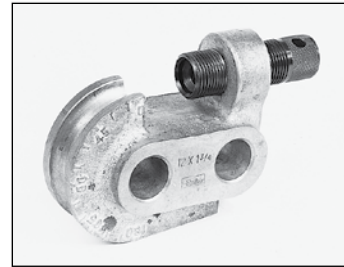


Fig. R29 — Close Bend Radius Block

Close Bend Radius Blocks – Inch Sizes

Size (in.)	Tube O.D. (in.)	Radius (in.)	Part No.
8	1/2	1 1/4	530597
10	5/8	1 1/2	530601
12	3/4	1 3/4	530605
14	7/8	2	530609
16	1	3	530613
20	1 1/4	3 3/4	530621
24	1 1/2	5	530625

Close Bend Adapters for Seal-Lok

These adapters are used when bends are needed close to the end of the tube after the flange has been made or the sleeve has been brazed onto the end of the tube.

HOW TO USE: Screw the Seal-Lok adapter into the internal thread* of the threaded pin on the radius block. Then attach the flanged or brazed tube by threading the tube nut to the Seal-Lok adapter on the radius block threaded pin.

* If the threaded pin does not have an internal thread, a new threaded pin is required.

Tube O.D. (in.)	Description	Part No.
1/2	Seal-Lok Adapter.....	930421-8
5/8	Seal-Lok Adapter.....	930421-10
3/4	Seal-Lok Adapter.....	930421-12
1	Seal-Lok Adapter.....	930421-16
1 1/4	Seal-Lok Adapter.....	930421-20
1 1/2	Seal-Lok Adapter.....	930421-24
1/2	Threaded Pin (for Close Bend Radius Blocks) ..	930420-8
5/8	Threaded Pin (for Close Bend Radius Blocks) ..	930420-10
3/4	Threaded Pin (for Close Bend Radius Blocks) ..	930420-12
1	Threaded Pin (for Close Bend Radius Blocks) ..	930420-16
1 1/4	Threaded Pin (for Close Bend Radius Blocks) ..	930420-20
1 1/2	Threaded Pin (for Close Bend Radius Blocks) ..	930420-24



Fig. R30 — Seal-Lok Close Bend Adapter

R

Close Bend Radius Blocks – Metric Sizes

Size (mm)	Radius (mm)	Thread Size	Part No.
12	32	3/4-16	780185
14	38	7/8-14	780186
15	38	7/8-14	780187
16	38	7/8-14	780188
18	44	1 1/16-12.....	780189
20	44	1 1/16-12.....	780190
38	127	1 7/8-12.....	530625

Dimensions and pressures for reference only, subject to change.

Bender Table (With Locking Casters) for HB632

Sturdy, heavy all steel construction, strongly braced to keep bender, mandrel rod, and mandrel rod stop assembly rigidly aligned. All holes are pre-drilled at factory to accommodate the HB632 bender and rod stop assembly.

DIMENSION: H – 36" W – 30" L – 10'

NOTE: Table is supplied with locking casters for ease of mobility.

Part Name	Part No.
Bender Table (with locking casters) for HB632	520515



Fig. R31 — Bender Table
 (equipment not included)



Mandrel Bending Components

When bending thin wall tube it may be necessary to insert a mandrel into the tube to prevent excessive distortion or flattening. To accomplish such bending, a Mandrel, Mandrel Rod, and a Mandrel Rod Stop Assembly are required. The Rod Stop Assembly holds the end of the Mandrel Rod in proper alignment with the tube while the Mandrel, which is threaded onto the other end of the Mandrel Rod, supports the tube on its I.D., thus preventing tube kinking or flattening during bending.

The following parts are required for mandrel bending with the 412 and 424 bender:

Part Name	Part No.
Mandrel Rod Stop Assembly	550571 (See page R18)
Stop Assembly Adapter Riser (424 only).....	631154 (See page R18)
Mandrel Rods	See page R17
Mandrel.....	See page R17

The following parts are required for mandrel bending with the 632 bender:

Part Name	Part No.
Mandrel Rod Stop Assembly	631141 (See page R18)
Mandrel Rods	See page R17
Mandrel.....	See page R17

Example:

Tube O.D.: 2"
 Wall Thickness: 0.095"
 Centerline Radius: 8"

Vertical Axis = $\frac{8"}{2"} = 4$

Horizontal Axis = $\frac{2"}{.095"} \approx 21$

Answer: Plug Mandrel required

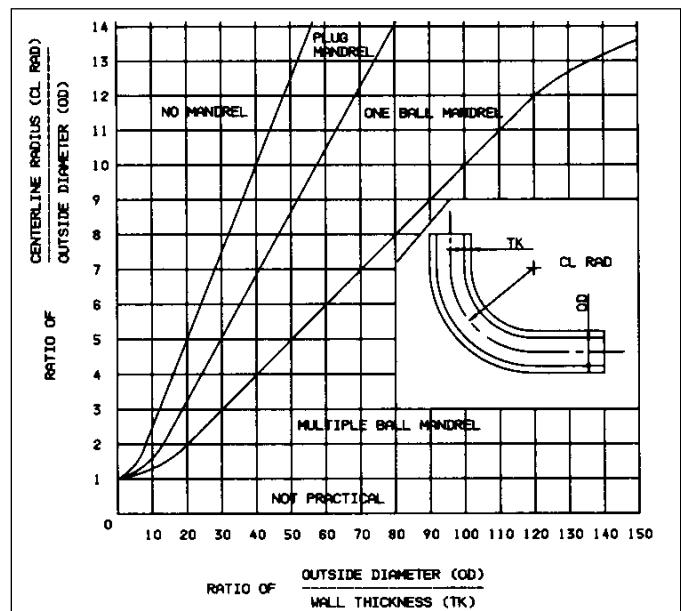


Fig. R32 — Mandrel Graph Chart

Dimensions and pressures for reference only, subject to change.

Mandrels (Plug Type)

For use with Exactol Models 412, 424 and the HB632 benders. Mandrels ensure smooth bends without kinking, or wrinkling when bending thin-walled tube, or when making short-radius bends. Mandrels support the tube wall from the inside to keep it fully open for a smooth bend.

A rule that is generally followed to determine whether or not a mandrel is necessary is as follows: When the wall thickness of the tube to be bent is 7 percent or more of the tube O.D., a mandrel is usually not necessary. On wall thicknesses that range between 4-6 percent of the tube O.D., it is necessary to use a mandrel to avoid wrinkling and flattening in the bend area. This rule is based on a bend radii of between three and four times the tube O.D.

Part Number Example: 924417-Size X Wall Thickness =
924417-12X058

* See Fig. R32 for mandrel usage.

To order mandrel, specify tube O.D. and wall thickness.



Fig. R33 — Mandrel

Size	END SIZE (in.)	Wall Thickness				
		(in.)	(in.)	(in.)	(in.)	(in.)
6	3/8	—	0.035	0.042	—	—
8	1/2	—	0.035	0.042	0.049	—
10	5/8	0.035	0.042	0.049	—	—
12	3/4	0.035	0.042	0.049	0.058	0.065
14	7/8	0.035	—	0.049	0.058	0.065
16	1	0.035	0.042	0.049	0.058	0.065
18	1 1/8	—	0.042	0.049	—	0.065
20	1 1/4	—	0.049	—	0.065	0.095
24	1 1/2	0.049	0.058	0.065	0.083	—

Table R4 — Mandrel Sizes

Mandrel Rods

For use with the HB632 Model Bender and Exactol Models 412/424 benders. Mandrel rods (as well as a mandrel rod stop assembly) are required when using mandrels. Mandrel rod diameters are determined by tube I.D.

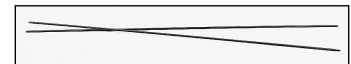


Fig. R34 — Mandrel Rods

Mandrel Rod Sizes

Mandrel Rod Dia. (in.)	Tube I.D. (in.)	Part No.
1/4	.283 to .362	520506
5/16	.363 to .484	520507
13/32	.485 to 1.489	520508
5/8	1.49 to 1.87	520509

Mandrel Rod Stop Assembly

For use with Model HB632 bender.

The Mandrel Rod Stop Assembly, when bolted to the end of a table opposite of the bender, keeps the mandrel rod in alignment with the tube when mandrel bending.

Part Name	Part No.
Mandrel Rod Stop Assembly (for bender Model HB632).....	631141
Mandrel Rod Stop Adapter for 5/16" Mandrel Rod	522398
Mandrel Rod Stop Adapter for 1/4" Mandrel Rod	550501

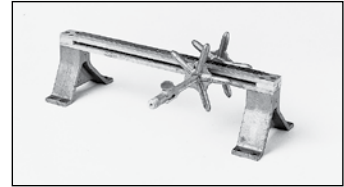


Fig. R35 — Mandrel Rod Stop Assembly /632

Mandrel Rod Stop Assembly

For use with Exactol 412/424 Model benders.

Part Name	Part No.
Mandrel Rod Stop Assembly	550571
Mandrel Rod Stop Adapter for 412/424 benders	820029

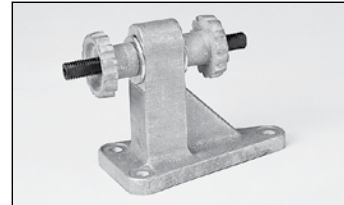


Fig. R36 — Mandrel Rod Stop Assembly 412/424

Part Name	Part No.
Stop Assembly Adapter/Riser for 424.....	631154

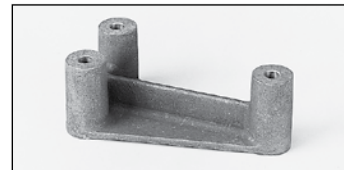


Fig. R37 — Stop Assembly Adapter/Riser

Universal Side Angle Indicator

For use with Model HB632 bender.

Accurately determines angle between tube bends in different planes. Keeps out of plane angles accurate, when making repeated bends. Large, easy-to-read vernier dial. Maximum 3/4" O.D. tube can be used if the tube must be extended through the indicator. Maximum 1 1/2" O.D. tube can be used if end of tube is held in clamp jaw.

Part Name	Part No.
Universal Side Angle Indicator	520520



Fig. R38 — Universal Side Angle Indicator

Dimensions and pressures for reference only, subject to change.

CP432 Tube and Pipe Bender

A 90 psi air supply does all the work for bending steel and stainless steel tube and pipe. This bender utilizes a center push bending method which is easy to master. Offered in an all inclusive kit. See Bulletin 4391-CP432 for more information. A separate accessory kit of tooling for bending 10mm through 50mm tube is also available. See page R20 for part number information.

Part Name	Part No.
CP432 Tube and Pipe Bender Kit.....	CP432
Includes all tooling necessary for bending 1/4" through 2" tube and 1/2 through 2" pipe.	

REPLACEMENT COMPONENTS

Part Name	Part No.
Air/Hydraulic Pump.....	PAT-1102N
Hose Assembly.....	975222
Quick Coupler, Receptacle.....	3050-3
Quick Coupler, Nipple.....	3010-3
Hydraulic Cylinder.....	RC-1010
Radius Blocks.....	See below
Slide Blocks.....	See below

Radius Blocks for CP432 – Inch Tube Sizes

Tube O.D. (in.)	Bend Radius (in.)	Part No.
1/4	9/16	975179
3/8	1 1/4	975179
1/2	1 1/2	975179
5/8	1 7/8	975180
3/4	2 1/4	975180
1	3	975181
1 1/4	3 3/4	975182
1 1/2	4 1/2	975183
2	8	975184

Slide Blocks for CP432 (2 required) – Inch Tube Sizes

Tube O.D. (in.)	Part No.
1/4.....	975185
3/8.....	975185
1/2.....	975185
5/8.....	975186
3/4.....	975186
1.....	975187
1 1/4.....	975187
1 1/2.....	975188
2.....	975188

*For inch pipe size radius blocks and slide blocks refer to Table R5 to right.



Fig. R39 — CP432 Bender Kit



Fig. R40 — Pump

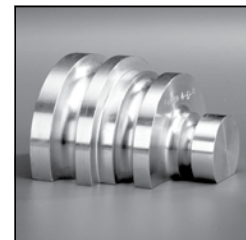


Fig. R41 — Multi-Size Tube Radius Block

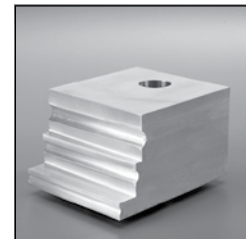


Fig. R42 — Multi-Size Tube Slide Block

Pipe Size	Bend Radius)	Radius Block Part #	Slide Block Part # (2 req'd.)	Drive Pin
1/2	3-3/16	BZ-12011	BZ-12071	A-12
3/4	5	BZ-12021		
1	5-7/8	BZ-12031		
1-1/4	7-1/4	BZ-12041		
1-1/2	8	BZ-12051		
2	9-1/2	BZ-12061		

Table R5 - Inch Pipe Sizes

Dimensions and pressures for reference only, subject to change.

Radius Blocks for CP432 – Metric Tube Sizes

Tube O.D. (mm)	Bend Radius (mm)	Part No.
10	34	976503-Block
12	34	976503-Block
14	38	976503-Block
15	38	976505
16	38	976505
18	42	976508
20	42	976508
22	89	976510
25	100	976510
30	100	976512
32	100	976515
35	105	976516
38	114	976517
42	128	976518
50	200	976519

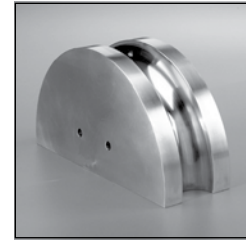


Fig. R43 — Typical Radius Block

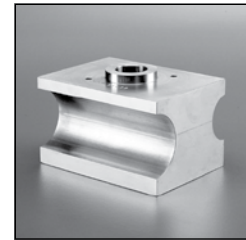


Fig. R44 — Typical Slide Block

TABLE OF CONTENTS

VISUAL INDEX

Slide Blocks for CP432 (2 required) – Metric Tube Sizes

Tube O.D. (mm)	Part No.
10	976504
12	976504
14	976504
15	976506
16	976506
18	976509
20	976509
22	976511
25	976511
30	976513
32	976513
35	976520
38	976520
42	976521
50	976521

ACCESSORIES

Part Name	Part No.
Metric Tooling Kit (10-50mm).....	*CP432-MM TOOL KIT

*Bender & pump is not included. CP432 is also needed.

Dimensions and pressures for reference only, subject to change.

TABLE OF CONTENTS

VISUAL INDEX

Kloskut® Tube Cutters

These adjustable tube cutters are designed to produce square cut ends with no external burr and minimum internal burr when used on fully annealed copper, brass, aluminum, and steel tube. Both feature a hardened and burnished tool-steel cutting wheel, flare cut-off grooves in rollers for removal of old flares and a swing-away reamer for removing internal burrs. The handle feeds and adjusts the cutting wheel to uniformly cut tube as the cutter is rotated.

NOTE: Tube cutters are **not recommended** for use with stainless steel tube because of the work hardening effect. The use of a hacksaw with a “Tru-Kut” Sawing Vise or a rotary teeth saw is recommended for stainless steel.

Medium Kloskut

Part Description	Part No.
Tube cutter for 1/8” to 1 1/8” O.D.....	218B
Cutter Wheel for 218B	218B Wheel
Cutter Shaft	218B Shaft

Large Kloskut

Part Description	Part No.
Tube Cutter for 3/4” to 2” O.D.....	1232
Cutter Wheel for 1232.....	1232 Wheel

Tru-Kut® Sawing Vise

This hacksaw guide will accommodate tube, pipe and hose from sizes 3 (3/16” O.D.) to 32 (2” O.D.), assuring square cut-offs within ± 1°. For use with a fine tooth hacksaw blade for smooth cuts.

HOW TO USE: Mount in a vise or bolt to a bench. Clamp tube, pipe or hose into the Tru-Kut vise and cut off; guide ensures accurate square cuts.

Part Description	Part No.
Tru-Kut Sawing Vise	710439

Cut-Off Saw

The 974250 Cut-Off Saw is designed to operate at low speed to prevent work hardening the tube end. The saw will assure a square cut on the tube with minimum burrs. The saw will cut 1/4” through 2 3/4” copper, brass, aluminum, steel and stainless steel tube. An adequate supply of cutting fluid is provided by an internal recirculating pump. The unit is designed for bench or stand mounting and operates on 110V, 15 amp power supply.

Part Description	Part No.
Cut-Off Saw	974250

Accessories	
Saw Base	AF160026

Replacement Parts	
Cutting Lubricant (Approx. 1 gal. container)	Saw Lube
Saw Blade – 250 mm x 2.0 mm thick (all purpose)	987036
Saw Blade – 200 mm x 2.0 mm thick (all purpose)	987037



Fig. R45 — 218B Medium Kloskut Tube Cutter



Fig. R46 — 1232 Large Kloskut Tube Cutter

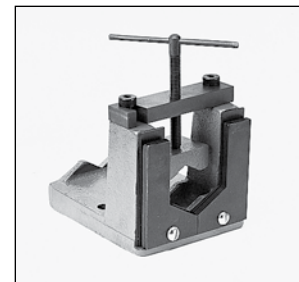


Fig. R47 — Tru-Kut Sawing Vise



Fig. R48 — Cut-Off Saw (shown on Saw Base)

Dimensions and pressures for reference only, subject to change.

TABLE
 OF
 CONTENTS

VISUAL
 INDEX

In-Ex® Tube Deburring Tool 226A

A quick twist of the wrist will deburr either the O.D. or the I.D. of the tube end. Parker's In-Ex deburrer can be used on annealed steel, stainless steel, copper and aluminum, for tube sizes 1/8" to 1 5/8" O.D.

Part Description	Part No.
In-Ex Deburring Tool.....	226A
Blade Set for 226A Tube Deburr Tool.....	226A Blades

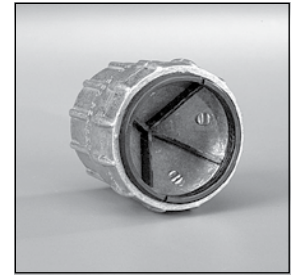


Fig. R49 — 226A In-Ex Deburr Tool

Power Deburr Tool

The Parker Power Deburr Tool is designed for deburring the I.D. and O.D. of 1/4" through 2" steel, stainless steel, copper and aluminum tube. The lightweight unit incorporates a modular design which allows Parker's Cut-Off Saw, part number 974250, to be easily mounted on the top. The Power Deburr Tool requires 110V/10A power supply.

Dimensions: L – 20", W – 18", H – 9".

Part Description	Part No.
Power Deburr Tool	972125

Replacement Parts	
I.D. Deburr Cone	971816
O.D. Deburr Blades (six blade set).....	910485



Fig. R50 — Power Deburr Tool

Dimensions and pressures for reference only, subject to change.

Parflange® 1025

Bench-Top 90° Flanging and 37° Flaring System

Tooling must be ordered separately

- Eliminates braze joint
- Compact, lightweight design
- Bench mountable
- Easy to operate
- Available in 110-volt single-phase or 440-volt 3-phase (please specify by ordering 1025/110 or 1025/440)
- Flanges or flares tube in less than 20 seconds
- For tube sizes 1/4" O.D. thru 1-1/2" O.D. (steel); and 1/4" O.D. thru 1" O.D. (stainless steel) – Flanging/flaring of tube sizes 1" & greater results in heavy machine vibration. Therefore, this machine is only recommended for occasional use for preparing tube ends 1" or larger.

Tooling is also available for comparable metric tube sizes.

Electrical Power: 110V/20A single-phase, or 440V/3-phase/2.1A

Power Cable Length: 8 feet long (2.5 meters)

Dimensions: Height: 18 1/8 inches (460mm)

Width: 15 3/8 inches (390mm)

Depth: 26 3/8 inches (670mm)

Weight: Basic Unit: 175 lbs. (80 kg.)

Each Die (typical): 4 lbs. (1.8 kg.)

Flanging Pin Lubrication Fluid: **LB2000**

See Bulletin 4390-1025A or 4390-1025 for more details.

A DVD is included to provide instructions for proper use.

COMPONENTS REQUIRED

Part Name	Part No.
Parflange 1025 (110 volt)	1025/110
Parflange 1025 (440 volt)	1025/440
Flanging Pin.....	See page R23
Flanging Die Set.....	See page R23
Flaring Pin	See page R33
Flaring Die Set.....	See page R33
Lubrication Fluid.....	LB 2000
Die Adjustment Shims (Old Style Dies Only).....	Shim Kit

REPLACEMENT PART

Part Name	Part No.
Tube Stop	1025/0281014

TABLE
OF
CONTENTS

VISUAL
INDEX



Fig. R51 — Parflange® 1025 Machine

CAUTION: Extension cords are **not** recommended and could cause damage to the machine due to a lack of power supply.



Fig. R52 — Flanging Pin

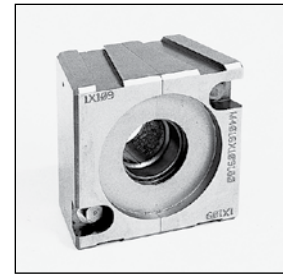


Fig. R53 — Flanging Die Set



Fig. R54 — LB 2000

R

Dimensions and pressures for reference only, subject to change.

Inch and Metric Flanging Tooling for 1025

TABLE
OF
CONTENTS

VISUAL
INDEX

Tube Size O.D. x Wall Thickness (in.)	Tooling for 90°/180° Tube Flanging			Available Flanging Tooling	
	Flange Pin and Die Set Part Number	Pin Part Number	Die Part Number	1025	
				-S	-SS
1/4 x .028	4004X028180	B4004X028180	M4004X028180	•	•
1/4 x .035	4004X035180	B4004X035180	M4004X035180	•	•
1/4 x .049	4004X049180	B4004X049180	M4004X049180	•	•
3/8 x .035	4006X035180	B4006X035180	M4006X035180	•	•
3/8 x .049	4006X049180	B4006X049180	M4006X049180	•	•
3/8 x .065	4006X065180	B4006X065180	M4006X065180	•	•
1/2 x .035	4008X035180	B4008X035180	M4008X035180	•	•
1/2 x .049	4008X049180	B4008X049180	M4008X049180	•	•
1/2 x .065	4008X065180	B4008X065180	M4008X065180	•	•
1/2 x .083	4008X083180	B4008X083180	M4008X083180	•	•
5/8 x .049	4010X049180	B4010X049180	M4010X049180	•	•
5/8 x .065	4010X065180	B4010X065180	M4010X065180	•	•
5/8 x .083	4010X083180	B4010X083180	M4010X083180	•	•
5/8 x .095	4010X095180	B4010X095180	M4010X095180	•	•
5/8 x .109	4010X109180	B4010X109180	M4010X109180	•	•
5/8 x .120	4010X120180	B4010X120180	M4010X120180	•	•
3/4 x .049	4012X049180	B4012X049180	M4012X049180	•	•
3/4 x .065	4012X065180	B4012X065180	M4012X065180	•	•
3/4 x .083	4012X083180	B4012X083180	M4012X083180	•	•
3/4 x .095	4012X095180	B4012X095180	M4012X095180	•	•
3/4 x .109	4012X109180	B4012X109180	M4012X109180	•	•
3/4 x .120	4012X120180	B4012X120180	M4012X120180	•	•
1 x .065	4016X065180	B4016X065180	M4016X065180	•	•
1 x .083	4016X083180	B4016X083180	M4016X083180	•	•
1 x .095	4016X095180	B4016X095180	M4016X095180	•	•
1 x .109	4016X109180	B4016X109180	M4016X109180	•	•
1 x .120	4016X120180	B4016X120180	M4016X120180	•	•
1 x .134	4016X134180	B4016X134180	M4016X134180	•	•
1 x .148	4016X148180	B4016X148180	M4016X148180	•	•
1 x .156	4016X156180	B4016X156180	M4016X156180	•	•
1 x .188	4016X188180	B4016X188180	M4016X188180	•	•
1 1/4 x .065	4020X065180	B4020X065180	M4020X065180	•	•
1 1/4 x .083	4020X083180	B4020X083180	M4020X083180	•	•
1 1/4 x .095	4020X095180	B4020X095180	M4020X095180	•	•
1 1/4 x .109	4020X109180	B4020X109180	M4020X109180	•	•
1 1/4 x .120	4020X120180	B4020X120180	M4020X120180	•	•
1 1/4 x .134	4020X134180	B4020X134180	M4020X134180	•	•
1 1/4 x .148	4020X148180	B4020X148180	M4020X148180	•	•
1 1/4 x .156	4020X156180	B4020X156180	M4020X156180	•	•
1 1/4 x .188	4020X188180	B4020X188180	M4020X188180	•	•
1 1/2 x .065	4024X065180	B4024X065180	M4024X065180	•	•
1 1/2 x .083	4024X083180	B4024X083180	M4024X083180	•	•
1 1/2 x .095	4024X095180	B4024X095180	M4024X095180	•	•
1 1/2 x .109	4024X109180	B4024X109180	M4024X109180	•	•
1 1/2 x .120	4024X120180	B4024X120180	M4024X120180	•	•
1 1/2 x .134	4024X134180	B4024X134180	M4024X134180	•	•
1 1/2 x .148	4024X148180	B4024X148180	M4024X148180	•	•
1 1/2 x .156	4024X156180	B4024X156180	M4024X156180	•	•
1 1/2 x .188	4024X188180	B4024X188180	M4024X188180	•	•

Note: Use “-SS” suffix after part number for flanging tools for stainless steel tube. Contact the Tube Fittings Division for sizes and/or materials not listed, or for additional SS sizes released for limited use.

Table R6 — Pin & Die Part Numbers for Inch Sizes

Tube Size O.D. x Wall Thickness (mm)	Tooling for 90°/180° Tube Flanging		Available Flanging Tooling	
	Pin Part Number	Die Part Number	1025	
			S	SS
6 x 1	B3018006X1M	M4018006X1M	•	•
6 x 1.5	B3018006X1.5M	M4018006X1.5M	•	•
8 x 1	B3018008X1M	M4018008X1M	•	•
8 x 1.5	B3018008X1.5M	M4018008X1.5M	•	•
10 x 1	B3018010X1M	M4018010X1M	•	•
10 x 1.5	B3018010X1.5M	M4018010X1.5M	•	•
10 x 2	B3018010X2M	M4018010X2M	•	•
12 x 1	B3018012X1M	M4018012X1M	•	•
12 x 1.5	B3018012X1.5M	M4018012X1.5M	•	•
12 x 2	B3018012X2M	M4018012X2M	•	•
15 x 1.5	B3018015X1.5M	M4018015X1.5M	•	•
15 x 2	B3018015X2M	M4018015X2M	•	•
16 x 1	B3018016X1M	M4018016X1M	•	•
16 x 1.5	B3018016X1.5M	M4018016X1.5M	•	•
16 x 2	B3018016X2M	M4018016X2M	•	•
16 x 2.5	B3018016X2.5M	M4018016X2.5M	•	•
18 x 1	B3018018X1M	M4018018X1M	•	•
18 x 1.5	B3018018X1.5M	M4018018X1.5M	•	•
18 x 2	B3018018X2M	M4018018X2M	•	•
20 x 2	B3018020X2M	M4018020X2M	•	•
20 x 2.5	B3018020X2.5M	M4018020X2.5M	•	•
20 x 3	B3018020X3M	M4018020X3M	•	•
22 x 1.5	B3018022X1.5M	M4018022X1.5M	•	•
22 x 2	B3018022X2M	M4018022X2M	•	•
22 x 2.5	B3018022X2.5M	M4018022X2.5M	•	•
22 x 3	B3018022X3M	M4018022X3M	•	•
25 x 2	B3018025X2M	M4018025X2M	•	•
25 x 2.5	B3018028X2.5M	M4018028X2.5M	•	•
25 x 3	B3018030X2M	M4018030X2M	•	•
25 x 3.5	B3018025X3.5M	M4018025X3.5M	•	•
25 x 4	B3018025X4M	M4018025X4M	•	•
28 x 2	B3018028X2M	M4018028X2M	•	•
28 x 2.5	B3018028X2.5M	M4018028X2.5M	•	•
30 x 2	B3018030X2M	M4018030X2M	•	•
30 x 3	B3018030X3M	M4018030X3M	•	•
30 x 3.5	B3018030X3.5M	M4018030X3.5M	•	•
30 x 4	B3018030X4M	M4018030X4M	•	•
32 x 3	B3018032X3M	M4018032X3M	•	•
32 x 4	B3018032X4M	M4018032X4M	•	•
35 x 3	B3018035X3M	M4018035X3M	•	•
38 x 3	B3018038X3M	M4018038X3M	•	•
38 x 4	B3018038X4M	M4018038X4M	•	•
38 x 5	B3018038X5M	M4018038X5M	•	•

Note: Flanging tools (90°/180°) listed are for carbon steel tube. Contact the Tube Fittings Division for metric flanging tools for tube materials other than carbon steel or for sizes not listed.

Table R7 — Pin & Die Part Numbers for Metric Sizes

Dimensions and pressures for reference only, subject to change.



Parflange® ECO 25

Bench-Top 90° Flanging and 37° Flaring System

Tooling and Hydraulic Pump must be ordered separately

- Eliminates braze joints
- More efficient than traditional flaring methods
- Only requires one die per tube size for both flanging and flaring
- For tube sizes 1/4" O.D. through 1-1/2" O.D. in both Steel and Stainless Steel
- Dies not dependent on wall thickness or tube material
- Uses same Parflange pins as 1025 and PRO 50 models
- Utilizes proven Parflange orbital process for consistent flanges and flares
- Burnishes flanges and flares for superior surface finish
- Compact, lightweight design
- Easy to operate
- Used with hand hydraulic pump
- 110-volt single-phase power
- Tooling also available in comparable metric sizes

Electrical Power: 110V/20A single-phase

Power Cable Length: 8 feet long (2.5 meters)

Dimensions: Height: 20.5 inches (520mm)

Width: 15 inches (381mm)

Depth: 20.5 (520mm)

Weight: 190 lbs. (86.4 kg.)

See Bulletin 4390-ECO 25 for more information and instructions for use.

COMPONENTS REQUIRED

Part Name	Part No.
*ECO 25 Basic Unit	ECO 25
*Hand Hydraulic Pump	900086
Flanging Pin.....	See page R26
Flaring Pin	See page R27
Flanging/Flaring Dual Function Die Set.....	See page R26 & R34
*Lubrication Fluid.....	LB 2000
*Hose Assembly (for hand pump).....	910133
*Pressure gauge (0 - 10,000 psi).....	900044
*Hydraulic Pump Adapter	6-6 FLO-S
*Hydraulic Pump Tee	6 R6LO-S
*Pressure Gauge Adapter	6 G6L-S
*Hose Conversion Adapter (#1).....	6 G6L-S
*Hose Conversion Adapter (#2).....	6-6 G6L-S

*Included in ECO 25 kit (Part Number ECO 25 KIT)



Fig. R55 — Parflange ECO 25

CAUTION: Extension cords are *not* recommended and could cause damage to the machine due to a lack of power supply.



Fig. R56 — Hand Pump

ECO 25 Kit

Part Name	Part No.
ECO 25 Kit (includes hand pump)	ECO 25 KIT

(Kit includes basic unit, hand hydraulic pump, hose assembly, pressure gauge, hydraulic pump adapter, hydraulic pump tee, pressure gauge adapter, hose conversion adapters #1 & #2, Lubrication fluid, and operation manual.)

Dimensions and pressures for reference only, subject to change.

Inch Flanging Tooling for ECO25

TABLE
OF
CONTENTS

VISUAL
INDEX

Tube O.D. (in.)	Die Set Part Number
1/4	M2504
3/8	M2506
1/2	M2508
5/8	M2510
3/4	M2512
1	M2516
1 1/4	M2520
1 1/2	M2524

Table R8 — Flanging Die Set, Inch Sizes

Tube O.D. (in.)	Wall Thickness (in.)	Flanging Pin Steel Tube	Flanging Pin Stainless Tube
1/4	0.028	B4004X028180	-
1/4	0.035	B4004X035180	B4004X035180SS
1/4	0.049	B4004X049180	B4004X049180SS
3/8	0.035	B4006X035180	B4006X035180SS
3/8	0.049	B4006X049180	B4006X049180SS
3/8	0.065	B4006X065180	B4006X065180SS
1/2	0.035	B4008X035180	B4008X035180SS
1/2	0.049	B4008X049180	B4008X049180SS
1/2	0.065	B4008X065180	B4008X065180SS
1/2	0.083	B4008X083180	B4008X083180SS
1/2	0.095	B4008X095181	B4008X095180SS
5/8	0.049	B4010X049180	B4010X049180SS
5/8	0.065	B4010X065180	B4010X065180SS
5/8	0.083	B4010X083180	B4010X083180SS
5/8	0.095	B4010X095180	B4010X095180SS
5/8	0.120	B4010X120180	-
3/4	0.049	B4012X049180	B4012X049180SS
3/4	0.065	B4012X065180	B4012X065180SS
3/4	0.083	B4012X083180	B4012X083180SS
3/4	0.095	B4012X095180	B4012X095180SS
3/4	0.104	-	B4012X104180SS
3/4	0.109	B4012X109180	B4012X109180SS
3/4	0.120	B4012X120180	B4012X120180SS
1	0.065	B4016X065180	B4016X065180SS
1	0.083	B4016X083180	B4016X083180SS
1	0.095	B4016X095180	B4016X095180SS
1	0.109	B4016X109180	B4016X109180SS
1	0.120	B4016X120180	B4016X120180SS
1	0.134	B4016X134180	B4016X134180SS
1	0.139	-	B4016X139180SS
1 1/4	0.065	B4020X065180	-
1 1/4	0.083	B4020X083180	B4020X083180SS
1 1/4	0.095	B4020X095180	B4020X095180SS
1 1/4	0.109	B4020X109180	B4020X109180SS
1 1/4	0.120	B4020X120180	B4020X120180SS
1 1/4	0.134	B4020X134180	-
1 1/2	0.065	B4024X065180	-
1 1/2	0.083	B4024X083180	-
1 1/2	0.095	B4024X095180	B4024X095180SS
1 1/2	0.109	B4024X109180	B4024X109180SS
1 1/2	0.120	B4024X120180	B4024X120180SS

Table R9 — Flanging Pin, Inch Sizes



Fig. R57 — Flanging Pin



Fig. R58 — Dual Function Die Set (Flaring and Flanging)

Dimensions and pressures for reference only, subject to change.

Manual Flaring Tool Vise Block and Flaring Pin — Metric Tube

These 37° flaring tools are designed for use in a vise when flaring metric tube from 6mm O.D. to 38mm O.D.

From 20mm size tube and upward it is necessary to use a pre-flaring pin to start the flare.

- **Clamp tube flush in black halves**
- **Flare tube by hammering the flaring pin.**

A separate block and pin set is used for each tube size.

Pre-Flaring Pins

Tube O.D. (mm)	Part No.
20	P1E
25	P1E
30	P1E
32	P1E
38	P1E

Flaring Pins

Tube O.D. (mm)	Part No.
6	P17408
8	P17408
10	P17408
12	P17414
14	P17414
15	P17414
16	P17414
18	P17418
20	P17418
25	P17422
30	P17432
32	P17432
38	P17438

Vise Blocks

Tube O.D. (mm)	Part No.
6	M27406
8	M27408
10	M27410
12	M27412
14	M27414
15	M27415
16	M27416
18	M27418
20	M27420
25	M27425
30	M27430
32	M27432
38	M27438



Fig. R59 — Vise Block



Fig. R60 — Pre-Flaring Pins



Fig. R61 — Flaring Pin

Vise Block with Flaring Pin

These impact 37° flaring tools are for use with copper, aluminum alloy, and thin wall steel or stainless steel. Separate tooling set for each tube size 4 (1/4" O.D.) through 24 (1 1/2" O.D.). Maximum wall thickness: 1/8" to 3/8" is 15% of tube O.D., 1/2" and larger is 10% of tube O.D.

HOW TO USE: Clamp tube flush in matching halves of block in a bench vise. Give hardened steel flaring pin a few **sharp** blows with a hammer to form the flare.

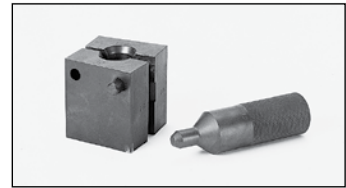


Fig. R62 — Vise Block with Flaring Pin

Size	Tube O.D. (in.)	Part No.
4	1/4	4-2866
5	5/16	5-2866
6	3/8	6-2866
8	1/2	8-2866
10	5/8	10-2866
12	3/4	12-2866
14	7/8	14-2866
16	1	16-2866
20	1 1/4	20-2866
24	1 1/2	24-2866

Order vise block with flaring pin using part numbers above. The block and pin may be ordered separately by suffixing the part number with either Pin or Block.

Part Number Example:
4-2866 Block

Rolo-Flair®

Manual Rotary Flaring Tool

(For soft metal tube)

Precision burnished 37° and 45° flares in tube sizes from 2 (1/8" O.D.) to 12 (3/4" O.D.) with an easy turn of the handle. For use with copper and aluminum alloys. A depth gauge allows proper positioning of tube for consistent flaring.

HOWTO USE: Open die, insert tube up to the gauge and clamp the tube in the die. Turn drive handle clockwise to flare, then counterclockwise for retracting flaring cone. Open clamping die by loosening wing nut and remove flared tube.

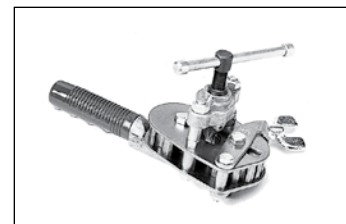


Fig. R63 — Rolo-Flair

Part Name	Part No.
Rolo-Flair for 37° flares (for 1/8", 3/16", 1/4", 5/16", 3/8", 1/2", 5/8", 3/4", O.D.)	212FB
Rolo-Flair for 45° flares (for 1/8", 3/16", 1/4", 5/16", 3/8", 1/2", 5/8", 3/4", O.D.)	945TH

Combination Flarer

Part No.
210A

For 1/8", 3/16", 1/4", 5/16", 3/8", 1/2", 5/8", O.D. tube.

The combination flarer is a 7-in-1 impact tool for flaring (37°) soft copper, aluminum and fully annealed steel tube, sizes 2 (1/8" O.D.) through 10 (5/8" O.D.). Maximum wall thickness: 1/8" to 3/8" is 15% of tube O.D., 1/2" and larger is 10% of tube O.D.

HOW TO USE: Insert tube into proper flare hole and fasten with clamping screw. Set hardened-steel flaring punch in tube and form flare with a few **sharp** hammer blows. (Tube should not project more than 1/16" above top of block.)

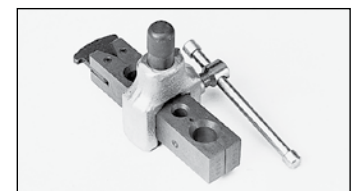


Fig. R64 — 210A Combination Flarer

Dimensions and pressures for reference only, subject to change.

Hydra-Tool

Hydraulic Flaring and Pre-Setting Tool

Flaring

An efficient dependable device for 37° and 45° flaring of steel, stainless steel and copper tube. This task is made easy through hydraulic power provided by a hand or electric pump. The equipment is portable and easy to use.

This tool accommodates dies for tubes ranging in inch sizes from 4 through 32 (1/4" through 2" outside diameters) with wall thicknesses as great as .134", and metric sizes from 6mm through 50mm. The hydraulic "push" of the Hydra-Tool flares the tube to a 37° flare angle. A gauge can be provided to enable the operator to determine the pressure required to adequately flare any given material and wall thickness of the tube. Complete instructions are included with the Hydra-Tool. See bulletin 4392-B10. See the following for Hydra-Tool basic unit or kit, and choice of power sources and necessary tooling.

NOTE: Flaring die sets and other tooling are available in non-standard sizes upon request from the factory.

See Appendix for flaring pressures.

COMPONENTS REQUIRED

Part Name	Part No.
*Hydra-Tool (basic unit)	710400B
*Hydra-Tool Male Adapter	6-8 F5OLO-S
*"T" Adapter for Gauge	6 R6LO-S
*Hose Assembly (for hand or electric pumps)	910004
*Adapter for Gauge.....	6 G6L-S
*Pressure Gauge (0 - 10,000 psi).....	900044
Electric Hydraulic Pump (10,000 psi; 1/2 hp; 40-125 volt)	900085
Hand Hydraulic Pump (10,000 psi; 2 speed)	900086
Die Ring (1/4" - 1 1/4") (6mm - 32mm)	710416A
Die Ring (1 1/2" - 2") (35mm - 50mm)	710412
37° Flaring Cone (1/4" - 1 1/4") (6mm - 32mm)	710419
37° Flaring Cone (1 1/2" - 2") (35mm - 50mm)	710411
Die Retainer Assembly (1/4" - 1 1/4") (6mm - 32mm).....	710424-1
Die Retainer Assembly (1 1/2" - 2") (35mm - 50mm).....	710424-2
Flaring Die Sets.....	See pages R30 - R31
45° Flaring Cone (1/4" - 1").....	910312

*Included in Hydra-tool kit (Part 720370B-3)
 STP Lubricant is the only lubricant recommended for use with Hydra-Tool.

Hydra-Tool Kit

Part Name	Part No.
Hydra-Tool Kit (for use with electric or hand pump).....	720370B-3
Includes basic unit, gauge adapter, Hydra-Tool connector, lubricant, "T" adapter, carrying case, hose assembly, pressure gauge, p/n 900044, operation manual and video.	



Fig. R65 — Hydra-Tool



Fig. R66 — Electric Pump



Fig. R67 — Hand Pump



Fig. R68 — Flaring Cone



Fig. R69 — Die Ring



Fig. R70 — Die Retainer



Fig. R71 — Hydra-Tool Kit

Dimensions and pressures for reference only, subject to change.

Hydra-Tool 37° Flaring Die Sets for Steel – Inch

Size	Tube O.D. (in.)	Part No.
4	1/4	710417-4
5	5/16	710417-5
6	3/8	710417-6
8	1/2	710417-8
10	5/8	710417-10
12	3/4	710417-12
14	7/8	710417-14
16	1	710417-16
20	1 1/4	710417-20
24	1 1/2	710415-24
32	2	710415-32

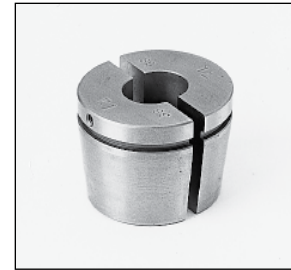


Fig. R72 — Flaring Die Set

TABLE
 OF
 CONTENTS

VISUAL
 INDEX

Hydra-Tool 37° Flaring Die Sets for Stainless Steel – Inch

Size	Tube O.D. (in.)	Part No.
4	1/4	710417-4 SS
5	5/16	710417-5 SS*
6	3/8	710417-6 SS
8	1/2	710417-8 SS
10	5/8	710417-10 SS
12	3/4	710417-12 SS
14	7/8	710417-14 SS*
16	1	710417-16 SS
20	1 1/4	710417-20 SS
24	1 1/2	710415-24 SS
32	2	710415-32 SS

* Non-standard.

Hydra-Tool 37° Flaring Die Sets – Metric

Tube O.D./ Size (mm)	Part No.
6	770106-6
8	770106-8
10	770106-10
12	770106-12
14	770106-14
15	770106-15
16	770106-16
18	770106-18
20	770106-20
22	770106-22
25	770106-25
28	770106-28
30	770106-30
32	770106-32
35	770095-35
38	770095-38
42	770095-42
50	770095-50

Dimensions and pressures for reference only, subject to change.

Hydra-Tool 45° Flaring Die Sets – Inch

TABLE
 OF
 CONTENTS

VISUAL
 INDEX

Size	Tube O.D. (in.)	Part No.
4	1/4	977420-4
6	3/8	977420-6
8	1/2	977420-8
10	5/8	977420-10
12	3/4	977420-12
14	7/8	977420-14
16	1	977420-16

REPLACEMENT PART

Part Name	Part No.
Tube Stop Assembly	710420B

OPTIONAL ACCESSORIES

Part Name	Part No.
Hydra-Tool Carrying Case	720377
Sturdy wood case for Hydra-Tool and tooling. (Hydra-Tool Kit is shipped in this carrying case.)	

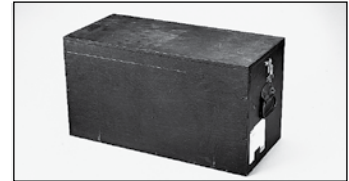


Fig. R73 — Carrying Case

R

Dimensions and pressures for reference only, subject to change.

TABLE
 OF
 CONTENTS

VISUAL
 INDEX

Karryflare Portable Flaring Machine

The Karryfare is a portable flaring machine that is designed for fabricating 37 degree tube flares. It's lightweight, portable, and is capable of flaring 1/4" through 1-1/2" (6mm-38mm) steel & stainless steel tubing. It's telescopic handle and wheeled carrying case allows it to be easily transported from one work site location to another.

Part Name **Part No.**
 Karry Flare KarryFlare

Hydraulic power is generated by a hand operated pump. A pressure gauge is provided which enables the operator to review the necessary pressure requirements for proper flaring of their specific tubing requirements (operating pressures are specific to the tubes O.D. and wall thickness). The complete unit is mounted on a wheeled base plate, with telescopic handle, and includes 37° cone and case cover.

Dimensions: H – 10" W – 14" L – 30"

Application range

The Karryflare machine is capable of flaring tube from 1/4" O.D. to 1 1/2" O.D. or from 6mm O.D. to 38mm O.D.

FLARING COMPONENTS

Part Name **Part No.**
 Replacement 37° Flaring Cone Karryflare/FPIN
 37° Flaring Die Sets See below

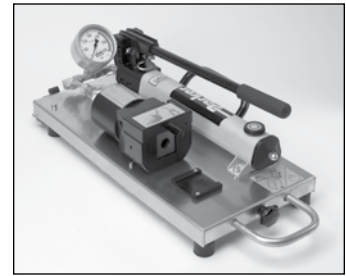


Fig. R74 — KarryFlare



Fig. R75 — Flaring Die Set

Tube Die Sets – Inch

Tube O.D. (in.)	Part No.
1/4	M 047415-1
5/16	M 157408-1
3/8	M 067415-1
1/2	M 087415
5/8	M 107415
3/4	M 127415
1	M 167415
1 1/4	M 207415
1 1/2	M 157438

Tube Die Sets – Metric

Tube O.D. (mm)	Part No.
6	M 157406-1
8	M 157408-1
10	M 157410-1
12	M 157412
14	M 157414
15	M 157415
16	M 157416
18	M 157418
20	M 157420
22	M 157422
25	M 157425
30	M 157430
32	M 157432
38	M 157438

Dimensions and pressures for reference only, subject to change.



Inch and Metric Flaring Tooling for 1025

Parflange® 1025 37° Flaring and Flanging Systems

Parker's Parflange 1025 machine is designed to create 37° flared tube ends. For more detailed information on the machine and part numbers, refer to page R23.



Fig. R76 — Parflange 1025

TABLE
OF
CONTENTS

VISUAL
INDEX

Tube Size O.D. x Wall Thickness (in.)	Tooling for 37°/74° Tube Flaring		Available Flaring Tooling
	Pin	Die	
	Part Number	Part Number	1025
1/4 x .020	B4004X020074	M4004074	•
1/4 x .028	B4004X028074	M4004074	•
1/4 x .035	B4004X035074	M4004074	•
1/4 x .049	B4004X049074	M4004074	•
1/4 x .065	B4004X065074	M4004074	•
3/8 x .020	B4006X020074	M4006074	•
3/8 x .028	B4006X028074	M4006074	•
3/8 x .035	B4006X035074	M4006074	•
3/8 x .049	B4006X049074	M4006074	•
3/8 x .065	B4006X065074	M4006074	•
1/2 x .028	B4008X028074	M4008074	•
1/2 x .035	B4008X035074	M4008074	•
1/2 x .049	B4008X049074	M4008074	•
1/2 x .065	B4008X065074	M4008074	•
1/2 x .083	B4008X083074	M4008074	•
5/8 x .035	B4010X035074	M4010074	•
5/8 x .049	B4010X049074	M4010074	•
5/8 x .065	B4010X065074	M4010074	•
5/8 x .083	B4010X083074	M4010074	•
5/8 x .095	B4010X095074	M4010074	•
3/4 x .035	B4012X035074	M4012074	•
3/4 x .049	B4012X049074	M4012074	•
3/4 x .065	B4012X065074	M4012074	•
3/4 x .083	B4012X083074	M4012074	•
3/4 x .095	B4012X095074	M4012074	•
3/4 x .109	B4012X109074	M4012074	•
1 x .035	B4016X035074	M4016074	•
1 x .049	B4016X049074	M4016074	•
1 x .065	B4016X065074	M4016074	•
1 x .083	B4016X083074	M4016074	•
1 x .095	B4016X095074	M4016074	•
1 x .109	B4016X109074	M4016074	•
1 x .120	B4016X120074	M4016074	•
1 1/4 x .049	B4020X049074	M4020074	•
1 1/4 x .065	B4020X065074	M4020074	•
1 1/4 x .083	B4020X083074	M4020074	•
1 1/4 x .095	B4020X095074	M4020074	•
1 1/4 x .109	B4020X109074	M4020074	•
1 1/4 x .120	B4020X120074	M4020074	•
1 1/2 x .065	B4024X065074	M4024074	•
1 1/2 x .083	B4024X083074	M4024074	•
1 1/2 x .095	B4024X095074	M4024074	•
1 1/2 x .109	B4024X109074	M4024074	•
1 1/2 x .120	B4024X120074	M4024074	•

Table R10 — Parflange Flaring Tooling for Inch Sizes

Tooling suitable for 37°/74° flaring of steel, stainless steel, aluminum, monel, copper, and cupro-nickel tube materials. For 37°/74° flaring, one die covers each tube O.D.; a different pin is required for each tube wall. Setscrews in flaring dies may require slight adjustment for different tube materials and/or tube walls.

Tube Size O.D. x Wall Thickness (mm)	Tooling for 37°/74° Tube Flaring		Available Flaring Tooling
	Pin	Die	
	Part Number	Part Number	1025
6 x 1	B3007406X1M	M4007406M	•
6 x 1.5	B3007406X1.5M	M4007406M	•
8 x 1	B3007408X1M	M4007408M	•
8 x 1.5	B3007408X1.5M	M4007408M	•
10 x 1	B3007410X1M	M4007410M	•
10 x 1.5	B3007410X1.5M	M4007410M	•
12 x 1.5	B3007412X1.5M	M4007412M	•
12 x 2	B3007412X2M	M4007412M	•
15 x 1.5	B3007415X1.5M	M4007415M	•
15 x 2	B3007415X2M	M4007415M	•
16 x 1.5	B3007416X1.5M	M4007416M	•
16 x 2	B3007416X2M	M4007416M	•
18 x 2	B3007418X2M	M4007418M	•
20 x 2	B3007420X2M	M4007420M	•
20 x 2.5	B3007420X2.5M	M4007420M	•
25 x 2	B3007425X2M	M4007425M	•
25 x 2.5	B3007425X2.5M	M4007425M	•
25 x 3	B3007425X3M	M4007425M	•
30 x 2.5	B3007430X2.5M	M4007430M	•
30 x 3	B3007430X3M	M4007430M	•
32 x 3	B3007432X3M	M4007432M	•
38 x 3	B3007438X3M	M4007438M	•
38 x 4	B3007438X4M	M4007438M	•

Table R11 — Parflange Flaring Tooling for Metric Sizes

Tooling suitable for 37°/74° flaring of steel, stainless steel, aluminum, monel, copper, and cupro-nickel tube materials. Apply LB 2000 lube to flaring pin. Setscrews in flaring dies may require slight adjustment for different tube materials and/or tube walls.



Fig. R77 — Flaring Pin



Fig. R78 — Flaring Die

R

Dimensions and pressures for reference only, subject to change.

Inch Flaring Tooling for ECO25

Parflange® ECO25 37° Flaring and Flanging Systems

Parker's Parflange ECO25 machine is designed to create 37° flared tube ends. For more detailed information on the machine and part numbers, refer to page R25.

Fitting Dash Size	Tube O.D. (in.)	Die Set Part Number
4	1/4	M2504
6	3/8	M2506
8	1/2	M2508
10	5/8	M2510
12	3/4	M2512
16	1	M2516
20	1 1/4	M2520
24	1 1/2	M2524

Table R12 — Flaring Die Set, Inch Sizes

Tube O.D. (in.)	Wall Thickness (in.)	Flaring Pin Part Number
1/4	0.028	B4004X028074
1/4	0.035	B4004X035074
1/4	0.049	B4004X049074
1/4	0.065	B4004X065074
3/8	0.020	B4006X020074
3/8	0.028	B4006X028074
3/8	0.035	B4006X035074
3/8	0.049	B4006X049074
3/8	0.065	B4006X065074
1/2	0.028	B4008X028074
1/2	0.035	B4008X035074
1/2	0.049	B4008X049074
1/2	0.065	B4008X065074
1/2	0.083	B4008X083074
5/8	0.035	B4010X035074
5/8	0.049	B4010X049074
5/8	0.065	B4010X065074
5/8	0.083	B4010X083074
5/8	0.095	B4010X095074
3/4	0.035	B4012X035074
3/4	0.049	B4012X049074
3/4	0.065	B4012X065074
3/4	0.083	B4012X083074
3/4	0.095	B4012X095074
3/4	0.109	B4012X109074
1	0.035	B4016X035074
1	0.049	B4016X049074
1	0.065	B4016X065074
1	0.083	B4016X083074
1	0.095	B4016X095074
1	0.109	B4016X109074
1	0.120	B4016X120074
1 1/4	0.049	B4020X049074
1 1/4	0.065	B4020X065074
1 1/4	0.095	B4020X095074
1 1/4	0.109	B4020X109074
1 1/4	0.120	B4020X120074
1 1/2	0.065	B4024X065074
1 1/2	0.083	B4024X083074
1 1/2	0.095	B4024X095074
1 1/2	0.109	B4024X109074
1 1/2	0.120	B4024X120074

Table R13 — Flaring Pin, Inch Sizes



Fig. R79 — Parflange ECO25



Fig. R80 — Flaring Pin



Fig. R81 — Dual Function Die Set (Flaring and Flanging)

TABLE OF CONTENTS

VISUAL INDEX

Dimensions and pressures for reference only, subject to change.

SAE Straight Thread Port Tapping Tools*

Taps are available for SAE J1926-1 female straight thread ports in sizes 2 through 32. Taps are bottoming type and made from high speed tool steel.

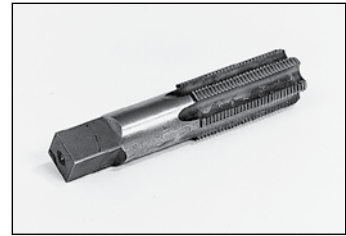


Fig. R82 — SAE Straight Thread Port Tapping Tool

SAE Dash Size	Overall Length (in.)	Shank Dia. (in.)	Wrench Flat Size (in.)	Part No.
2	2 23/32	0.318	0.238.....	5/16X24 UNF-2B
3	2 15/16	0.381	0.286.....	3/8X24 UNF-2B
4	3 5/16	0.323	0.242.....	7/16X20 UNF-2B
5	3 3/8	0.367	0.275.....	1/2X20 UNF-2B
6	3 19/32	0.429	0.322.....	9/16X18 UNF-2B
8	4 1/4	0.590	0.442.....	3/4X16 UNF-2B
10	4 11/16	0.697	0.523.....	7/8X14 UNF-2B
12	5 1/8	0.896	0.672.....	1 1/16X12 UNF-2B
14	5 7/16	1.021	0.766.....	1 3/16X12 UNF-2B
16	5 3/4	1.108	0.831.....	1 5/16X12 UNF-2B
20	6 11/16	1.305	0.979.....	1 5/8X12 UNF-2B
24	7 5/16	1.519	1.139.....	1 7/8X12 UNF-2B
32	8 3/4	2.100	1.575.....	2 1/2X12 UNF-2B

SAE Straight Thread Port Counterboring Tools*

Parker offers counterboring tools for SAE J1926-1 female straight thread ports in sizes 2 through 32. Counterbores are 4-fluted high speed tool steel.

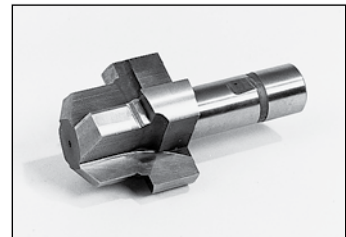


Fig. R83 — SAE Straight Thread Port Counterboring Tool

SAE Dash Size	Shank Dia. (in.)	Shank Length (in.)	Overall Length (in.)	Recommended Pilot Drill or Bore Size (in.)	Part No.
2	1/2	1 1/2	2 1/2	0.266	Y-34730
3	1/2	1 1/2	2 1/2	0.328	Y-34731
4	1/2	1 1/2	2 41/64	0.377	Y-34732
5	1/2	1 1/2	2 41/64	0.438	Y-34733
6	3/4	1 1/2	2 47/64	0.500	Y-34734
8	3/4	1 1/2	2 53/64	0.672	Y-34735
10	1	2	3 29/64	0.797	Y-34736
12	1	2	3 19/32	0.969	Y-34737
14	1	2	3 41/64	1.095	Y-34738
16	1	2	3 41/64	1.220	Y-34739
20	1 1/2	2	3 37/64	1.530	Y-34740
24	1 1/2	2	3 37/64	1.780	Y-34741
32	1 1/2	2	3 49/64	2.405	Y-34743

* See Appendix for recommended use of port tools.

Dimensions and pressures for reference only, subject to change.

BSPP Straight Thread Port Counterboring Tools*

Parker offers counterboring/spotfacing tools for DIN 3852-2 female straight thread port connections in sizes 1/8" through 1-1/2". Counterbores are carbide tipped.

SAE Dash Size	Overall Length (in.)	Shank Dia. (in.)	Wrench Flat Size (in.)	Part No.
2	2 23/32	0.318	0.238.....	5/16X24 UNF-2B
3	2 15/16	0.381	0.286.....	3/8X24 UNF-2B
4	3 5/16	0.323	0.242.....	7/16X20 UNF-2B
5	3 3/8	0.367	0.275.....	1/2X20 UNF-2B
6	3 19/32	0.429	0.322.....	9/16X18 UNF-2B
8	4 1/4	0.590	0.442.....	3/4X16 UNF-2B
10	4 11/16	0.697	0.523.....	7/8X14 UNF-2B
12	5 1/8	0.896	0.672.....	1 1/16X12 UNF-2B

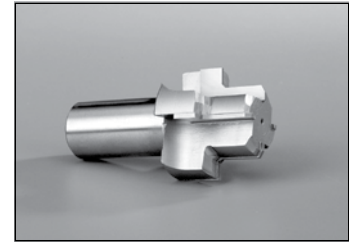


Fig. R84 — BSPP Straight Thread Port Counterboring Tool

BSPP Straight Thread Tapping Tools*

BSPP taps are available for ISO 228-1 threaded connections in sizes 1/8" through 1 1/2". All taps are bottoming type manufactured from high speed steel.

	Shank Dia. (in.)	Shank Length (in.)	Overall Length (in.)	Recommended Pilot Drill or Bore Size (in.)	Part No.
G1/8	1/2	1 1/2	2 1/2	0.332	974094-G1/8
G1/4	1/2	1 1/2	2 1/2	0.438	974094-G1/4
G3/8	3/4	1 1/2	2 1/2	0.578	974094-G3/8
G1/2	3/4	2	3	0.728	974094-G1/2
G3/4	1	2	3	0.938	974094-G3/4
G1	1	2	3 1/2	1.181	974094-G1
G1-1/4	1 1/2	2	3 1/2	1.531	974094-G1-1/4
G1-1/2	1 1/2	2	3 1/2	1.750	974094-G1-1/2

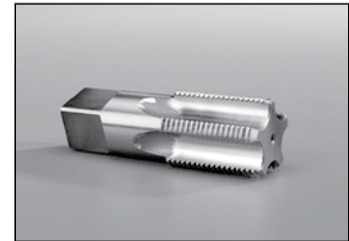


Fig. R85 — BSPP Straight Thread Tapping Tool

BSPT Taper Pipe Thread Tapping Tools*

BSPT taps are available for ISO 7-1 taper thread connections in sizes 1/8" through 1 1/2". All taps are bottoming type manufactured from high speed steel.

Size	Shank Dia. (in.)	Overall Length (in.)	Thread Size	Part No.
R1/8	0.438	2 1/8	1/8-28.....	974243-R1/8
R1/4	0.563	2 7/16	1/4-19.....	974243-R1/4
R3/8	0.700	2 9/16	3/8-19.....	974243-R3/8
R1/2	0.688	3 1/8	1/2-14.....	974243-R1/2
R3/4	0.906	3 1/4	3/4-14.....	974243-R3/4
R1	1.125	3 3/4	1-11.....	974243-R1
R1-1/4	1.313	4	1 1/4-11.....	974243-R1-1/4
R1-1/2	1.500	4 1/4	1 1/2-11.....	974243-R1-1/2

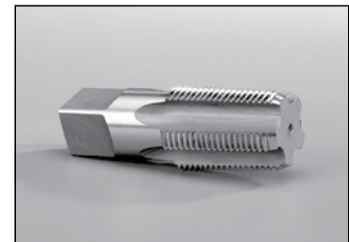


Fig. R86 — BSPT Taper Pipe Thread Tapping Tool

* See Appendix for recommended use of port tools.

Dimensions and pressures for reference only, subject to change.

TABLE
 OF
 CONTENTS

VISUAL
 INDEX

NPTF Thread Tapping Tools*

NPTF taps are available for taper pipe thread connections in sizes 1/8" through 1 1/2". All taps are bottoming type manufactured from high speed steel.

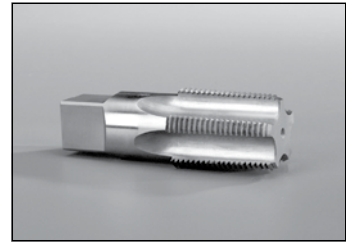


Fig. R87 — NPTF Port Tap

Shank Dia. (in.)	Overall Length (in.)	Thread Size	Part No.
0.438	2 1/8	1/8-27	974244-1/8
0.563	2 7/16	1/4-18	974244-1/4
0.700	2 9/16	3/8-18	974244-3/8
0.688	3 1/8	1/2-14	974244-1/2
0.906	3 1/4	3/4-14	974244-3/4
1.125	3 3/4	1-11 1/2	974244-1
1.313	4	1 1/4-11 1/2	974244-1-1/4
1.500	4 1/4	1 1/2-11 1/2	974244-1-1/2

ISO 6149-1 Straight Thread Port Tapping Tools*

ISO 6149-1 female straight thread port taps are available for M8 to M48 port sizes. Taps are bottoming type and made from high speed steel.



Fig. R88 — ISO 6149-1 Straight Thread Port Tap

Overall Length (in.)	Shank Dia. (in.)	Wrench Flat Size (in.)	Thread Size	Part No.
2 23/32	0.318	0.238	M8x1	M8X1 D5 2FL
2 15/16	0.381	0.286	M10x1	M10X1-6H
3 3/8	0.367	0.275	M12x1.5	M12X1.5-6H TAP
3 19/32	0.429	0.322	M14x1.5	M14X1.5-6H-TAP
3 13/16	0.400	0.360	M16x1.5	M16X1.5-6H-TAP
4 1/32	0.542	0.406	M18x1.5	M18X1.5-6H-TAP
4 11/16	0.697	0.523	M22x1.5	M22X1.5-6H-TAP
5 1/8	0.896	0.672	M27x2	M27X2-6H-TAP
5 3/4	1.108	0.831	M33x2	M33X2-6H-TAP
7	1.430	1.072	M42x2	M42X2-6H-TAP
7 5/8	1.644	1.233	M48x2	M48X2-6H-TAP

* See Appendix for recommended use of port tools.

Dimensions and pressures for reference only, subject to change.

TABLE
 OF
 CONTENTS

VISUAL
 INDEX

ISO 6149-1 Straight Thread Port Counterboring Tools — Small Spotface*

ISO 6149-1 female straight thread port counterboring tools are available with small spotface for M8 to M48 port sizes. Counterbores are 4-fluted*, carbide-tipped.

Shank Dia. (in.)	Shank Length (in.)	Overall Length (in.)	Recommended Pilot Drill or Bore Size (in.)	Use with Thread Size	Part No.
1/2	2	4 1/8	0.272	M8x1*	R1449B
1/2	2	4 1/8	0.348	M10x1*	R1450B
1/2	2	4 1/8	0.406	M12x1.5	R 1451B-S
1/2	2	4 1/8	0.484	M14x1.5	R 1452B-S
1/2	2	4 1/8	0.563	M16x1.5	R 1453B-S
1/2	2	4 1/8	0.641	M18x1.5	R 1454B-S
1/2	2	4 1/8	0.797	M22x1.5	R 1455B-S
3/4	2 1/2	5	0.969	M27x2.....	R 1456B-S
3/4	2 1/2	5	1.210	M33x2.....	R 1457B-S
3/4	2 1/2	5	1.565	M42x2.....	R 1458B-S
3/4	2 1/2	5	1.801	M48x2	R1459B

* M8 and M10 are 3-fluted



Fig. R89 — ISO 6149-1 Straight Thread Port Counterboring Tool — Small Spotface

ISO 6149-1 Straight Thread Port Counterboring Tools with ID Groove*

ISO 6149-1 female straight thread port counterboring tools are available with identification groove for M8 to M48 port sizes. Counterbores are 4-fluted*, carbide-tipped.

Shank Dia. (in.)	Shank Length (in.)	Overall Length (in.)	Recommended Pilot Drill or Bore Size (in.)	Use with Thread Size	Part No.
1/2	2	4 1/8	0.348	M10x1*	R1450A
1/2	2	4 1/8	0.406	M12x1.5	R1451A
1/2	2	4 1/8	0.484	M14x1.5	R1452A
1/2	2	4 1/8	0.563	M16x1.5	R1453A
1/2	2	4 1/8	0.641	M18x1.5	R1454A
1/2	2	4 1/8	0.797	M22x1.5	R1455A
3/4	2 1/2	5	0.969	M27x2.....	R1456A
3/4	2 1/2	5	1.210	M33x2.....	R1457A

* M10 are 3-fluted

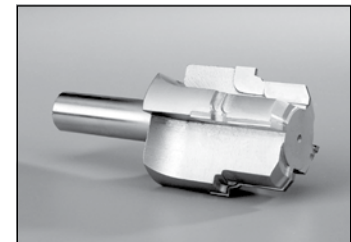


Fig. R90 — ISO 6149-1 Straight Thread Port Counterboring Tool with ID Groove

* See Appendix for recommended use of port tools.

Dimensions and pressures for reference only, subject to change.

Ferulset® Pre-Setting Tool

For Ferulok® flareless tube fittings.

Ferulset provides a fast and easy way to manually pre-set the ferrule onto steel and stainless steel tube with the famous Ferulok “bite.” Ferulset bodies are manufactured from hardened steel for withstanding repeated pre-sets. A separate tool is required for each size tube; size 2 (1/8” O.D.) through size 32 (2” O.D.).

HOW TO USE: Lubricate threads on tool, threads on nut, as well as tail and lead ends of ferrule with a suitable lubricant such as STP. Insert tube end with ferrule into tool until it bottoms against shoulder and thread the nut down until finger tight. Light wrenching may be required to get to a consistent starting position, especially with larger sizes. Hold tube steady against internal shoulder and tighten nut 1-3/4 turns. Loosen nut and inspect bite using inspection criteria outlined for Ferulok in the Assembly / Installation section.



Fig. R91 — Ferulset®

TABLE
 OF
 CONTENTS

VISUAL
 INDEX

Size	Tube O.D. (in.)	Part No.
2	1/8	560576
3	3/16	560577
4	1/4	560578
5	5/16	560579
6	3/8	560580
8	1/2	560581
10	5/8	560582
12	3/4	560583
14	7/8	560584
16	1	560585
20	1 1/4	560586
24	1 1/2	560587
32	2	560589

R

Dimensions and pressures for reference only, subject to change.

VOMO Pre-Assembly Bodies

For EO and EO-2 Flareless Metric Tube Fittings

VOMO tools are made of hardened tool-steel, for standard assembly of steel fittings, stainless steel fittings and hose standpipes (BE).

Refer to the EO/EO2 Assembly and Installation section for use information (page S28).

NOTE: It is strongly recommended that a hydraulic tool be used to preset EO and EO-2 fittings in sizes 30S, 35L, 38S and 42L.

Series	Tube O.D. (mm)	Part No.
LL	4	VOMO04LLX
LL	6	VOMO06LLX
LL	8	VOMO08LLX
LL	10	VOMO10LLX
LL	12	VOMO12LLX
L	6	VOMO06LX
L	8	VOMO08LX
L	10	VOMO10LX
L	12	VOMO12LX
L	15	VOMO15LX
L	18	VOMO18LX
L	22	VOMO22LX
L	28	VOMO28LX
L	35	VOMO35LX
L	42	VOMO42LX
S	6	VOMO06SX
S	8	VOMO08SX
S	10	VOMO10SX
S	12	VOMO12SX
S	14	VOMO14SX
S	16	VOMO16SX
S	20	VOMO20SX
S	25	VOMO25SX
S	30	VOMO30SX
S	38	VOMO38SX



Fig. R92 — VOMO Pre-Assembly Tool

TABLE OF CONTENTS

VISUAL INDEX

Dimensions and pressures for reference only, subject to change.

Hyferset

Parker Hydraulic Ferrule Pre-Setting Tool for Ferulok® Fittings and EO/EO-2 Metric Fittings

PORTABLE...EFFICIENT...EASY TO USE

The Hyferset is an efficient, dependable device for pre-setting Parker ferrules on tube of steel and stainless steel. This task is made easy through hydraulic power provided by a hand or electric pump. The equipment is portable, and has an optional sturdy wood carrying case.

In hydraulic pre-setting, little physical strength is required by the operator to set ferrules properly. Although the amount of force needed increases as the ferrule size increases, the pressure can be easily achieved.

This tool accommodates pre-setting dies for tubes ranging in size from 4 through 32 (1/4" through 2" outside diameter) and 6mm to 28mm O.D. metric sizes. The tube, with tube nut and ferrule, is positioned in the die. The hydraulic "push" of the Hyferset pre-sets the ferrule onto the tube — producing a visible ridge of metal, in front of the sleeve bite edge, that can be easily inspected.

Positive Stop Body Dies (For Ferulok Fittings Only)

The positive stop body die design eliminates the need for predetermined relief valve settings, pressure gauges or chart reading. Positive stop feature allows for uniform assemblies to be made on tube from 1/4" thru 2". One set of dies can be used on both steel and stainless steel tube. When used in conjunction with the Ferulok visible bite ferrules, the entire system is the most reliable method available for assembling a fitting to a piece of tube.

See Appendix for pre-setting pressures for EO and EO-2 steel fittings.

You will find instructions for proper use in the 4393-B1 user manual.

COMPONENTS REQUIRED

Part Name	Part No.
*Hyferset (basic unit, no accessories)	611011A
*Hyferset Adapter	6 FLO-S
Gauge "T" Adapter	6 R6LO-S
*Hose Assembly	910004
Gauge Swivel Adapter	6 G6L-S
Pressure Gauge (0 - 10,000 psi)	900044
*Hand pump (10,000 psi, 2 speed)	900086
Electric pump (10,000 psi, 1/2 HP, 40-125 volt)	900085
Nut die set (1/4" to 2" O.D.)	See page R42
Positive Stop body die (1/4" to 2" O.D.)	See page R42
Nut Die Set (6mm to 28mm)	See page R43
Body Die (6mm to 28mm)	See page R43

* Included in Hyferset Kit

Part Name	Part No.
Hyferset Kit	611049C
Includes basic unit, hand hydraulic pump, hose assembly, 1 adapter (6 FLO-S), wooden carrying case, operation manual and video.	



Fig. R93 — Hyferset



Fig. R94 — Electric Pump



Fig. R95 — Hand Pump

R



Fig. R96 — Hyferset Kit

Dimensions and pressures for reference only, subject to change.

OPTIONAL ACCESSORIES

Part Name	Part No.
Wooden carrying case.....	651085

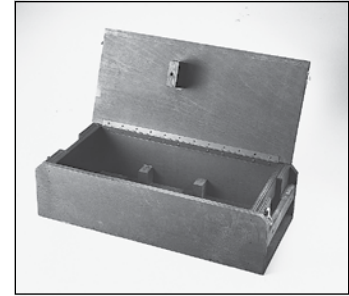


TABLE
 OF
 CONTENTS

VISUAL
 INDEX

Hyferset Body Dies for Ferulok Fittings

Size	Tube O.D. (in.)	Part No.
4	1/4	720105-4
6	3/8	720105-6
8	1/2	720105-8
10	5/8	720105-10
12	3/4	720105-12
14	7/8	720105-14
16	1	720105-16
20	1 1/4	720105-20
24	1 1/2	720105-24
32	2	720105-32

Fig. R97 — Hyferset Wood Carrying Case



Fig. R98 — Body Die

Hyferset Nut Dies for Ferulok Fittings

Size	Tube O.D. (in.)	Part No.
4	1/4	680370-4
6	3/8	680370-6
8	1/2	680370-8
10	5/8	680370-10
12	3/4	680370-12
14	7/8	680370-14
16	1	680370-16
20	1 1/4	680370-20
24	1 1/2	680370-24
32	2	680370-32



Fig. R99 — Nut Die

Dimensions and pressures for reference only, subject to change.

TABLE
 OF
 CONTENTS

VISUAL
 INDEX

Hyferset Body Dies for EO / EO-2 Fittings

Series	Tube O.D. Size (mm)	Part No.
L	6.....	910290-6L
L	8.....	910290-8L
L	10.....	910290-10L
L	12.....	910290-12L
L	15.....	910290-15L
L	18.....	910290-18L
L	22.....	910290-22L
L	28.....	910290-28L
S	6.....	910289-6S
S	8.....	910289-8S
S	10.....	910289-10S
S	12.....	910289-12S
S	14.....	910289-14S
S	16.....	910289-16S
S	20.....	910289-20S
S	25.....	910289-25S



Fig. R100 — Body Die

Hyferset Nut Dies for EO / EO-2 Fittings

Tube O.D. Size (mm)	Part No.
6.....	910291-6 mm
8.....	910291-8 mm
10.....	910291-10 mm
12.....	910291-12 mm
14.....	910291-14 mm
15.....	910291-15 mm
16.....	910291-16 mm
18.....	910291-18 mm
20.....	910291-20 mm
22.....	910291-22 mm
25.....	910291-25 mm
28.....	910291-28 mm

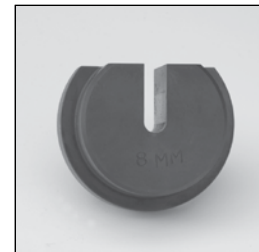


Fig. R101 — Nut Die

R

Dimensions and pressures for reference only, subject to change.



Hydra-Tool

Pre-Setting Components

COMPONENTS REQUIRED

Part Name	Part No.
*Hydra-Tool (basic unit) (Fig. S98).....	710400B
Hand pump (10,000 psi, 2 speed)	900086
Electric pump (10,000 PSI, 1/2 HP, 40-125 volt)	900085
*Hose Assembly	910004
Back-up Plate (sizes -4 to -32 and 6mm to 28mm)	770102
Back-up Plate (sizes 30 to 42mm).....	See page R45
Ram Insert (sizes -4 to -32).....	770101
Small Ram Insert (EO & EO-2 only).....	971108
Large Piston Stop Adapter (EO & EO-2 only)	971107
Nut die set (1/4" to 2" O.D.).....	See below
Positive Stop body die (1/4" to 2" O.D.).....	See below
Nut Die Set (6mm to 42mm).....	See page R45
Body Die (6mm to 42mm).....	See page R45
*Pressure Gauge (0 - 10,000 psi).....	900044
*Male Adapter.....	6-8 F5OLO-S
*Adapter.....	6 G6L-S
*Hydra-Tool Gauge Adapter	6 R6LO-S

* Included in Kit

STP lubricant is the only lubricant recommended for use with the Hydra-Tool.

See Appendix for pre-setting pressures.

Hydra-Tool Kit

Part Name	Part No.
Hydra-Tool Kit (for use with electric or hand pump).....	720370B-3
Includes basic unit, gauge adapter, Hydra-Tool connector, lubricant, "T" adapter, carrying case, hose assembly, pressure gauge, p/n 900044, operation manual and video.	

Hydra-Tool Body Dies for Ferulok Fittings

Size	Tube O.D. (in.)	Part No.
4	1/4	720105-4
6	3/8	720105-6
8	1/2	720105-8
10	5/8	720105-10
12	3/4	720105-12
14	7/8	720105-14
16	1	720105-16
20	1 1/4	720105-20
24	1 1/2	720105-24
32	2	720105-32

Hydra-Tool Nut Dies for Ferulok Fittings

Size	Tube O.D. (in.)	Part No.
4	1/4	680370-4
6	3/8	680370-6
8	1/2	680370-8
10	5/8	680370-10
12	3/4	680370-12
14	7/8	680370-14
16	1	680370-16
20	1 1/4	680370-20
24	1 1/2	680370-24
32	2	680370-32

Dimensions and pressures for reference only, subject to change.

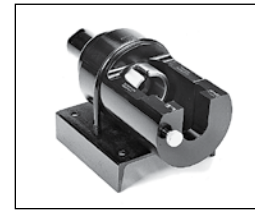


Fig. R102 — Hydra Tool



Fig. R103 — Ram Insert (Ferulok Only)

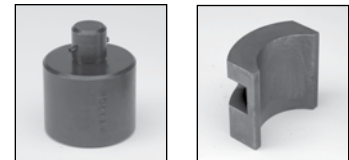


Fig. R104 — Small Ram Insert and Stop Adapter (EO and EO-2 only)



Fig. R105 — Hydra-Tool Kit



Fig. R106 — Body Die



Fig. R107 — Nut Die

TABLE
 OF
 CONTENTS

VISUAL
 INDEX

Hydra-Tool Body Dies for EO / EO-2 Fittings

Series	Tube O.D. Size (mm)	Part No.
L	6	910290-6L
L	8	910290-8L
L	10	910290-10L
L	12	910290-12L
L	15	910290-15L
L	18	910290-18L
L	22	910290-22L
L	28	910290-28L
L	35	910290-35L
L	42	910290-42L
S	6	910289-6S
S	8	910289-8S
S	10	910289-10S
S	12	910289-12S
S	14	910289-14S
S	16	910289-16S
S	20	910289-20S
S	25	910289-25S
S	30	910289-30S
S	38	910289-38S



Fig. R108 — Body Die

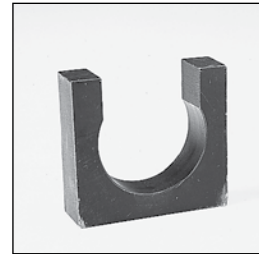


Fig. R109 — Back up Plate

Hydra-Tool Nut Die / Split Back-up Plate Sets for EO / EO-2 Fittings

Tube O.D. Size (mm)	Part No.
6	910291-6 mm
8	910291-8 mm
10	910291-10 mm
12	910291-12 mm
14	910291-14 mm
15	910291-15 mm
16	910291-16 mm
18	910291-18 mm
20	910291-20 mm
22	910291-22 mm
25	910291-25 mm
28	910291-28 mm
30	970135-30 mm
35	970135-35 mm
38	970135-38 mm
42	970135-42 mm

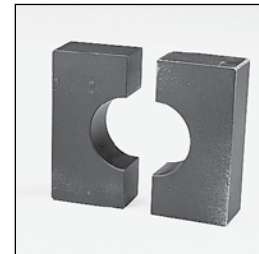


Fig. R110 — Split Nut Dies

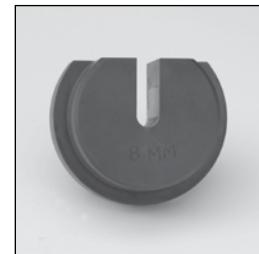


Fig. R111 — Nut Die

R

Dimensions and pressures for reference only, subject to change.

EO-Karrymat

The EO-Karrymat is a dependable device for safe and efficient bite-type pre-setting. It allows pre-assembly of all sizes of EO, EO-2 and Ferulok fittings without the need for electric power.

The EO-Karrymat consists of a hydraulic drive, Handpump and pressure gauge, all firmly attached to a carrying case.

Part Name	Part No.
EO-Karrymat	EOKarrymat

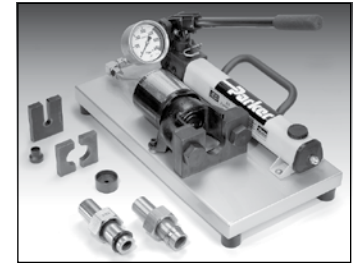


Fig. R112 — EO-Karrymat

TABLE
 OF
 CONTENTS

VISUAL
 INDEX

EO-Karrymat Body Dies for EO / EO-2 Fittings

Series	Tube O.D. (mm)	Part No.
LL	4	MOK04LLX
LL	6	MOK06LLX
LL	8	MOK08LLX
LL	10	MOK10LLX
LL	12	MOK12LLX
L	6	MOK06LX
L	8	MOK08LX
L	10	MOK10LX
L	12	MOK12LX
L	15	MOK15LX
L	18	MOK18LX
L	22	MOK22LX
L	28	MOK28LX
L	35	MOK35LX
L	42	MOK42LX
S	6	MOK06SX
S	8	MOK08SX
S	10	MOK10SX
S	12	MOK12SX
S	14	MOK14SX
S	16	MOK16SX
S	20	MOK20SX
S	25	MOK25SX
S	30	MOK30SX
S	38	MOK38SX



Fig. R113 — MOK Body Die

Dimensions and pressures for reference only, subject to change.

TABLE
 OF
 CONTENTS

VISUAL
 INDEX

EO-Karrymat Nut Dies for EO / EO-2 Fittings

Series	Tube O.D. (mm)	Part No.
LL	4	GHP04X
LL	6	GHP06X*
LL	8	GHP08X*
LL	10	GHP10X*
LL	12	GHP12X*
L	6	GHP06X*
L	8	GHP08X*
L	10	GHP10X*
L	12	GHP12X*
L	15	GHP15X
L	18	GHP18X
L	22	GHP22X
L	28	GHP28X
L	35	GHP35X
L	42	GHP42X
S	6	GHP06X*
S	8	GHP08X*
S	10	GHP10X*
S	12	GHP12X*
S	14	GHP14X
S	16	GHP16X
S	20	GHP20X
S	25	GHP25X
S	30	GHP30X
S	38	GHP38X

* Nut Dies for 6-12mm are identical in LL, L and S series.



Fig. R114 — GHP Nut Die

EO-Karrymat Body Dies for Ferulok Fittings

Tube Size (in.)	Part No.
1/4	976521-4
3/8	976521-6
1/2	976521-8
5/8	976521-10
3/4	976521-12
7/8	976521-14
1	976521-16
1 1/4	976521-20
1 1/2	976521-24
2	976521-32

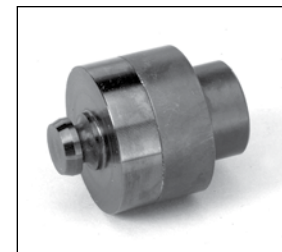


Fig. R115 — EO-Karrymat Body Die for Ferulok

EO-Karrymat Back-up Plates for Ferulok Fittings

Tube Size (in.)	Part No.
1/4	975867-4
3/8	975867-6
1/2	975867-8
5/8	975867-10
3/4	975867-12
7/8	975867-14
1	975867-16
1 1/4	975867-20
1 1/2	975867-24
2	975867-32



Fig. R116 — EO-Karrymat Back-up Plates for Ferulok

R

Dimensions and pressures for reference only, subject to change.

TABLE
 OF
 CONTENTS

VISUAL
 INDEX

O-Ring Pick

Plastic O-ring pick allows for easy removal of O-rings without causing damage to the fitting.

Part Name **Part No.**
 O-Ring Pick O-Ring Pick

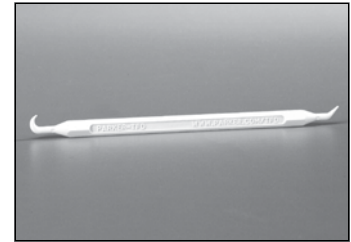


Fig. R117 — O-Ring Pick

Captive O-Ring Assembly Tool

The captive O-ring (CORG) assembly tool utilizes a Parker patented method for inserting O-rings in ORFS fittings, such as Seal-Lok, without causing O-ring damage. These tools can be used both as a hand tool and a bench-mounted tool. All CORG tools have a #8-32 tapped hole to allow easy mounting.

Fitting Size	L (in.)	D1 (in.)	D2 (in.)	O-Ring Size	Part No.
-4	1.4	0.8	0.6	2-011	CORG-4
-6	1.5	0.9	0.6	2-012	CORG-6
-8	1.5	1.1	0.8	2-014	CORG-8
-10	1.6	1.3	0.9	2-016	CORG-10
-12	1.9	1.4	1.1	2-018	CORG-12
-16	1.9	1.7	1.3	2-021	CORG-16
-20	2.1	1.9	1.6	2-025	CORG-20
-24	2.1	2.3	1.9	2-029	CORG-24
-32	2.2	2.8	2.4	2-135	CORG-32



Fig. R118 — Captive O-Ring Assembly Tool

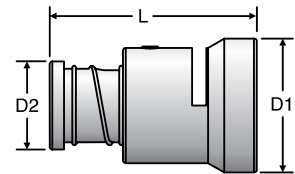


Fig. R119 — Captive O-Ring Assembly Tool dimensions

Dimensions and pressures for reference only, subject to change.

TABLE
 OF
 CONTENTS

VISUAL
 INDEX

Braze Flux

Black braze flux can be used for brazing either steel or stainless steel components. When applied liberally this flux helps the flow of the silver braze alloy and prevents oxidation.

Part Name	Part No.
Black Flux	Black Flux 1/2 lb
Black Flux	Black Flux 1 lb

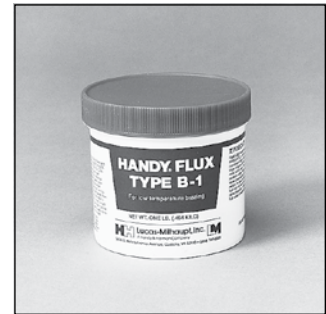


Fig. R120 — Braze Flux

Post Braze Cleaner

This cleaner is used to clean the assembly after brazing. Once the silver braze alloy has solidified, immediately immerse the joint into the braze cleaner solution. The cleaner combined with the sudden change in temperature removes the flux from the assembly. Braze cleaner does not provide corrosion protection. See “Corrosion Protection After Brazing” in the Assembly / Installation section, page S17.

Available in sizes 2 1/2 lb. and 5 lb. jars. When ordering simply denote quantity after Braze Cleaner.

Part Name	Part No.
Braze Cleaner.....	Braze Cleaner 2 1/2 lb
Braze Cleaner.....	Braze Cleaner 5 lb



Fig. R121 — Post Braze Cleaner

R

Dimensions and pressures for reference only, subject to change.

Lubricants

Lubricants act as friction reducers to ease forming processes, fitting assembly and prevent galling, corrosion and seizing of components. The use of the correct lubricant for various purposes is critical to achieve maximum tool life during forming processes and performance of threaded connections.

Parflange® Lubricants

Lubricants are used to maximize tool life during the flanging process. Selection of the appropriate lubricant for the type of Parflange machine is critical to its proper operation.

Part Description
 Recommended for use with steel or stainless steel

Part No.
LB 2000 (8 oz.)



Fig. R122 — Parflange Lubricant, LB 2000

EO / EO-2 Fitting Lubricants

EO Niromont lubricants are specifically developed for lubrication of threads prior to assembly of EO and EO-2 fittings.

Part Description
 EO Niromont – Liquid 250cc bottle.....
 EO Niromont – Paste 130 g. tin

Part No.
Niromont Liquid
Niromont Paste



Fig. R123 — EO Niromont

O-Ring Lubricants

Parker O-Lube

O-Lube is an outstanding general-purpose grease intended for use with O-rings and other seals in hydraulic and pneumatic systems. The temperature range is from -29°C to +82°C (-20°F to +180°F).

Part Description
 O-ring Lubricant 2 oz.

Part No.
OLUBE-884-2-TFD



Fig. R124 — Parker O-Lube

Parker Super O-Lube

Super O-Lube is an all-purpose O-ring lubricant. It is not a grease, but rather a high-viscosity silicone oil. The temperature range is -54°C to +204°C (-65°F to +400°F).

Part Description
 O-ring Lubricant.....

Part No.
SLUBE-884-2-TFD



Fig. R125 — Parker Super O-Lube

Dimensions and pressures for reference only, subject to change.

TABLE
OF
CONTENTS

VISUAL
INDEX

Thread Sealants

Thread sealants seal and secure metal pipes and fittings by filling the space between the threaded metal parts. Thread sealants harden to prevent leakage caused by vibration loosening, solvent evaporation, damaged threads and temperature cycling. Designed for low and high pressure applications, thread sealants seal quickly for on-line low pressure testing. When fully cured, they seal to the burst strength of most systems. Thread sealants are easily removed with basic hand tools. Thread sealants can be used on pipe thread fittings.

Threadmate™ Sealant/Lubricant

Threadmate™ is an extreme-duty lubricant developed to reduce galling during the assembly of pipe thread fittings. Threadmate™ promotes reliable sealing of pipe threads, even at high pressure. Recommended for use on stainless steel pipe threads.

Size available

4 oz. tube

Part No.

MTM04T-TFD



Fig. R126 — Threadmate Sealant/Lubricant

R

Dimensions and pressures for reference only, subject to change.



Tube Preparation Centers

Parker offers five different styles of tube preparation centers to meet various user's needs, from the basic TP-1 unit which includes a cabinet and deburr unit, to the TP1025 which offers the ability to cut, deburr, Parflange and flare tube.

Utilizing a sturdy steel cabinet with bins for fitting storage, tooling shelves and heavy duty casters to ease mobility, Parker Tube Preparation Centers cover almost every tube preparation need. All machines require 110V, 20A power supply.

Part Description

Part Description	Part No.
Tube Prep Center with Deburr Unit.....	TP-1
Tube Prep Center with Deburr and Saw	TP-974250
Tube Prep Center with Deburr, Saw and Hydratool	TP432
Tube Prep Center with Deburr, Saw and Hyferset	TP-611011A
Tube Prep Center with Deburr, Saw and Karryflare Tool	TP-Karryflare
Tube Prep Center with Deburr, Saw and 1025 Parflange	TP1025

Replacement Parts

Replacement Parts	Part No.
I.D. Deburr Cone	971816
O.D. Deburr Blades (set of 6).....	910485
Cutting Lubricant	Saw Lube
Saw Blade – 250 mm x 2.0 mm thick (all purpose)	987036
Saw Blade – 200 mm x 2.0 mm thick (all purpose)	987037
Flaring tooling for TP432	See page R29 – R31
Presetting tooling for TP432 and TP-611011A	See page R41 – R43
Karryflare Flaring tooling	See page R32
Flanging tooling for TP1025.....	See page R24
Flaring tooling for TP1025	See page R33
Lubricant for TP1025	LB 2000



Fig. R127 — Tube Preparation Center TP1025

TABLE
 OF
 CONTENTS

VISUAL
 INDEX

Dimensions and pressures for reference only, subject to change.

Thread Identification Kit

The Thread Identification Kit can be used to identify metric, BSP, SAE and NPT threads, as well as SAE flanges. It contains thread gauges, calipers, thread profiles, and an instruction booklet that details most thread forms and connection styles found in fluidpower systems worldwide.

Part Name Thread Identification Kit..... **Part No.** MIK-1



Fig. R128 — Thread Identification Kit

Portboards

The Portboards can be used for identification of ISO, SAE, BSP and NPT ports and port threads. They are machined with female threads for quick and easy identification by screwing in the male port end.

Portboard A (SAE Straight Thread -2 through -32 and NPT 1/8 through 1 1/2).

Part Name Portboard A **Part No.** Portboard A



Fig. R129 — Portboard A

Portboard B (Metric 8mm through 48mm and BSP 1/8 through 1 1/2).

Part Name Portboard B **Part No.** Portboard B



Fig. R130 — Portboard B

International Thread Kit

Parker's International Thread Kit offers the necessary tools to identify almost any thread you may encounter. The new ITK has LL, L and S series plugs to identify female DIN threads such as EO style hose ends. It also includes the MIK-1 and BSPP plugs in order to identify BSPP hose ends from 1/8" to 2".

Part Name International Thread Kit **Part No.** ITK



Fig. R131 — International Thread Kit (ITK)

Dimensions and pressures for reference only, subject to change.

Par-Lok® Wrench

360° Snap-action ratchet wrench for hex sizes from 3/8" to 2 1/4" across the flats and metric from 10mm to 50mm. Inch sizes meet government specifications and are listed as NSN-5120-00-474-7227. Wrenches are covered by a limited lifetime warranty. Damage due to over-torque is not covered by warranty.

Install Tube Fittings Faster

Easy access ratchet wrench speeds fittings installation in tight locations. Rugged, snap-action jaws can be opened over tube lines, locked onto fitting hex and ratcheted within 1/8 turn. Full six point contact prevents fitting distortion common with wrench slippage. Ideal for tube line installations where compact runs require multiple fittings make-up, disassembly and remakes.

Specifications

Par-Lok wrenches are available individually or in six different kit combinations. Par-Lok jaws are constructed from drop-forged, high carbon steel material with a black conversion coat finish. Par-Lok handles are made from heavy gauge steel material, heat treated and with a corrosion resistant black finish. Solid stainless steel rivets and tempered jaw springs are designed into every wrench for maximum strength.

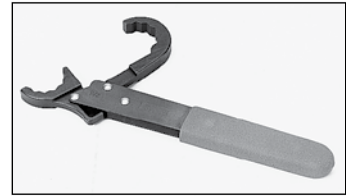


Fig. R132 — Par-Lok Wrench



Fig. R133 — Par-Lok Wrench Kit

Inch Hex Size Par-Lok Wrenches

Hex Size (in.)	Max. Torque (ft.-lbs.)	Part No.
3/8	24	860062-6
7/16	27	860062-7
1/2	32	860062-8
9/16	43	860062-9
5/8	65	860062-10
11/16	81	860062-11
3/4	92	860062-12
13/16	108	860062-13
7/8	135	860062-14
15/16	152	860062-15
1	162	860062-16
1 1/8	206	860062-18
1 1/4	238	860062-20
1 3/8	282	860062-22
1 1/2	314	860062-24
1 5/8	346	860062-26
1 7/8	364	860062-30
2	373	860062-32
2 1/4	391	860062-36

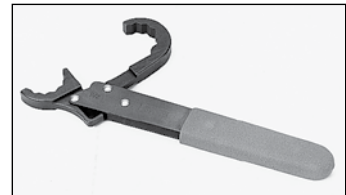


Fig. R134 — Par-Lok Wrench



Fig. R135 — Seal-Lok Wrench Kit

Part Description	Part No.
Full kit of sizes 3/8" to 1"	860062-KIT
Full kit of sizes 1 1/8" to 2 1/4"	860062-KIT2
Seal-Lok Wrench Kit	
(5/8", 11/16", 3/4", 13/16", 7/8", 15/16")	860062-LKIT
Triple-Lok and Ferulok Wrench Kit	
(9/16", 11/16", 7/8", 1", 1 1/4")	860062-XUKIT

Dimensions and pressures for reference only, subject to change.

Metric Hex Size Par-Lok Wrenches

Hex Size (mm)	Max. Torque (ft.-lbs.)	Max. Torque (N-m)	Part No.
10	26	35	860063-10
11	27	37	860063-11
12	31	42	860063-12
13	33	45	860063-13
14	42	57	860063-14
16	65	88	860063-16
17	79	107	860063-17
19	92	125	860063-19
21	110	149	860063-21
22	131	178	860063-22
24	154	209	860063-24
27	74	100	860063-27
30	74	100	860063-30
32	125	170	860063-32
36	125	170	860063-36
41	229	310	860063-41
46	243	330	860063-46
50	243	330	860063-50

Part Description	Part No.
Full kit of sizes 10mm to 22mm	860063-KIT
Full kit of sizes 27mm to 50mm	860063-KIT2



Fig. R136 — Triple-Lok and Ferulok Wrench Kit



Fig. R137 — Par-Lok Wrench Kit

TABLE OF CONTENTS

VISUAL INDEX

R

Dimensions and pressures for reference only, subject to change.

Tube Fabricating Equipment Weights		Tube Fabricating Equipment Weights		Tube Fabricating Equipment Weights	
Part No.	Approx. Ship Weight (lbs.)	Part No.	Approx. Ship Weight (lbs.)	Part No.	Approx. Ship Weight (lbs.)
Vise Block with Flaring Pin		Ferulset Tools (Ferulok Pre-Set Tool)		Straight Thread Taps and Counterbores (Cont'd)	
4-2866	2.00	560576	0.50	Y-34730	0.50
5-2866	2.00	560577	0.50	Y-34731	0.50
6-2866	3.00	560578	0.50	Y-34732	0.50
8-2866	3.50	560579	0.50	Y-34733	0.75
10-2866	4.00	560580	0.50	Y-34734	1.00
12-2866	12.00	560581	0.50	Y-34735	1.00
14-2866	15.00	560582	0.50	Y-34736	1.50
16-2866	18.00	560583	0.50	Y-34737	1.50
20-2866	18.00	560584	0.50	Y-34738	1.75
24-2866	20.00	560585	0.50	Y-34739	2.00
Combination Flaring Tool		560586	0.50	Y-34740	2.00
210A	3.00	560587	1.00	Y-34741	2.50
Rolo-Flare Tool		560589	1.00	Y-34743	2.50
945 TH	4.00	Hyferset (Ferulok Pre-Set Tool)		Par-Lok Wrenches	
212FB	4.00	611011A	35.00	860062-Kit	4.50
Hydra-Tool		Hyferset Accessories		860062-Kit 2	28.00
710400B	62.00	900086	10.00	860063-Kit	4.00
720370B-3	85.00	910004	2.00	Tube Cutters	
Accessories (Hydra-Tool)		651085	15.00	218B	1.00
900044	1.00	Hyferset and Tooling		1232	3.00
910004	1.50	611049C	53.00	Parker Tru-Kut Sawing Vise	
720377	16.00	680370-4	3.50	710439	9.00
710416	4.00	720105-4	0.50	974250	198.00
710412	3.00	680370-6	3.00	Deburring Tools	
710419	2.00	720105-6	0.50	226A	1.00
710411	2.00	680370-8	3.00	972125	90.00
710424-1	4.00	720105-8	0.50	Hand Tube Benders	
710424-2	4.00	680370-10	2.50	2-2829S	2.00
710417-4	2.00	720105-10	0.50	3-2829S	2.00
710417-5	2.00	680370-12	2.50	4-2829S	2.50
710417-6	2.00	720105-12	0.50	5-2829S	2.50
710417-8	2.00	680370-14	2.50	6-2829S	3.00
710417-10	2.00	720105-14	0.50	8-2829S	3.00
710417-12	2.00	680370-16	1.50	10-2829	8.00
710417-14	2.00	720105-16	1.00	12-2829	15.00
710417-16	2.00	680370-20	2.00	14-2829	15.00
710417-20	2.00	720105-20	1.00	16-2829	16.00
710415-24	2.00	680370-24	1.50	4-2829AH	1.20
710415-32	2.00	720105-24	1.00	6-2829AH	3.70
Power Source (Pumps)		680370-32	1.50	8-2829AH	7.60
900085	30.00	720105-32	1.00	Exactol Tube Benders (412 & 424)	
900086	10.00	Straight Thread Taps and Counterbores		560569	18.50
Flaring Dies - Metric (Hydra-Tool)		7/16-20 UNF-2B	1.00	550570	5.00
770106-6	2.00	9/16-18 UNF-2B	1.00	550572	25.50
770106-8	2.00	3/4-16 UNF-2B	1.00	621044	38.00
770106-10	2.00	7/8-14 UNF-2B	1.50	631156	10.00
770106-12	2.00	1 1/16-12 UN-2B	1.75	412 Kit	42.00
770106-16	2.00	1 3/16-12 UN-2B	2.00	424 Kit	—
770106-18	2.00	1 5/16-12 UN-2B	2.00	Slide Blocks (412 & 424)	
770106-20	2.00	1 5/8-12 UN-2B	2.50	550585	3.50
770106-25	2.00	1 7/8-12 UN-2B	2.50	621045	5.00
770106-30	2.00	2 1/2-12 UN-2B	3.00	870150	5.00
770106-32	2.00				
Hydra-Tool					
Ferulok Pre-Set Tooling					
770101	5.00				
770102	3.00				

TABLE OF CONTENTS

VISUAL INDEX

Table R14 — Tube Fabricating Equipment Weight Chart

Dimensions and pressures for reference only, subject to change.



(Continued on next page)

TABLE
OF
CONTENTS

VISUAL
INDEX

Tube Fabricating Equipment Weights		Tube Fabricating Equipment Weights		Tube Fabricating Equipment Weights	
Part No.	Approx. Ship Weight (lbs.)	Part No.	Approx. Ship Weight (lbs.)	Part No.	Approx. Ship Weight (lbs.)
Radius Blocks (412 & 424)		HB632 Hydraulic Tube Bender		Clamp Blocks for HB632	
550579	1.00	631050 (632)	245.00	864266	4.00
550580	1.00	660221	8.00	631092	3.00
550581	2.50	900085	30.00	631093	3.00
550582	3.00	Radius Blocks (HB632)		027418-28	5.00
550583	4.00	540502	3.00	027418-32	5.00
550584	5.00	530763	3.50	Metric Clamp Blocks for HB632	
621046	7.00	530764	4.00	790017	3.00
621047	9.00	530765	6.00	780194	4.00
621048	9.50	530766	10.00	780195	3.00
621049	10.00	530768	14.00	780186	4.00
870149	11.00	530770	54.00	Metric Slide Blocks for HB632	
Small Radius Blocks (412 & 424)		590512-18	35.00	790016	8.00
550573	2.00	590515-24	4.00	780191	11.00
550574	2.00	590518-30	6.00	780192	9.00
550575	2.50	590521-36	7.00	780193	8.00
550576	2.50	590523-42	8.00	Bender Table	
550577	3.00	590524-48	10.00	520515	470.00
550578	4.00	590526-54	12.00	Mandrel Rod Stop Assemblies	
Close Bend Radius Blocks		590630-72	16.00	550571	5.00
590533	2.00	631060-128	50.00	631141	20.00
590535	3.00	Close Bend Radius Blocks for HB632		Universal Side Angle Indicator	
590537	3.00	530597	3.50	520520	25.00
Metric Slide Blocks (412 & 424)		530601	5.00	Karryflare Inch Flaring Dies for Karryflare	
820091	3.00	530605	6.00	M 047415-1	4.00
820092	5.00	530609	8.00	M 157408-1	4.00
820093	5.00	530613	10.50	M 067415-1	4.00
Metric Radius Blocks (412 & 424)		530621	12.00	M 087415	4.00
820090-6mm	1.00	530625	13.00	M 107415	3.50
820090-8mm	2.00	Metric Radius Blocks for HB632		M 127415	3.50
820090-10mm	2.00	810023	3.00	M 167415	3.50
820090-12mm	3.00	780175	3.50	M 207415	3.00
820090-14mm	3.00	780176	4.00	M 157438	3.00
820090-16mm	4.00	780177	4.00	Parflange Tooling	
820090-18mm	4.50	780178	5.00	Pin and Die Set (1025)	4.50
820090-20mm	6.50	780179	6.00	Pin (1025)	.75
820090-22mm	7.00	780180	8.00	Die (1025)	3.75
820090-25mm	9.00	780181	9.00	CP432 Parflange Machines	
820090-28mm	9.50	780182	10.50	1025	175.00
820090-30mm	10.00	780183	12.00	Metric Close Bend Radius Blocks for HB632	
820090-32mm	10.50	780184	13.00	780185	3.50
Tube Preparation Centers		CP432 Parflange Machines		780186	3.50
TP432	560.00	1025		780187	4.00
TP1025	880.00	Metric Close Bend Radius Blocks for HB632		780188	5.00
EO Presetting Tooling		780185		780189	6.00
Nut Die	1.75	780186		780190	6.50
Body Die	.75	780187			
EO-Karrymat	55.00	780188			
		780189			
		780190			

R

Table R14 — Tube Fabricating Equipment Weight Chart (cont'd.)

Dimensions and pressures for reference only, subject to change.





Fig. T47 — Tube not bottomed



Fig. T48 — Shallow bite



Under-flare

Min. flare O.D. should at least equal sleeve seat O.D.



Over-flare

Max. flare O.D. should not exceed sleeve seat O.D.



Fig. T49 — Over-set ferrule



Fig. T50 — Ferrule cocked on tube

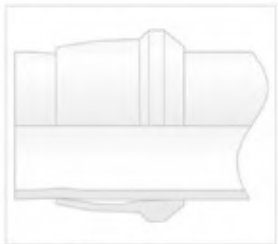


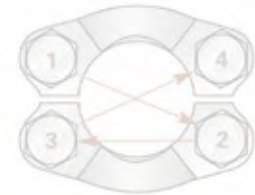
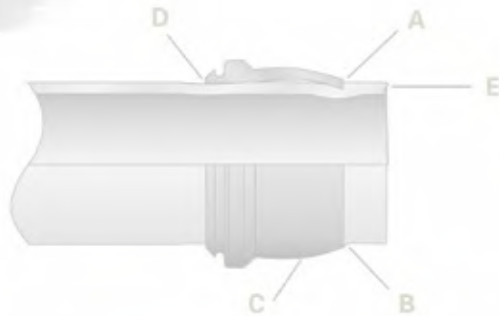
Fig. T51 — No bite



Improper Cut



Proper Cut



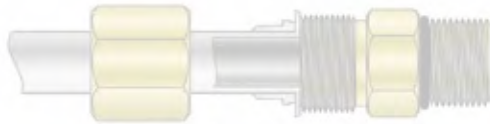
Recommended bolt torque sequence



Step 6



Step 7 and 8



Over-flanged Assembly



Under-flanged Assembly



Fig. T19 — Flange diameter

Assembly/Installation

Table of Contents

Port End Assembly	S3	EO-2 Metric Bite Type Fittings	S32
Parallel Thread Ports	S3	Pre-set of the Retaining Ring	S32
Adjustable Port End Assembly	S4	Pre-set Using the Fitting Body or Hardened Pre-assembly Tool	S32
Non-adjustable Port End Assembly	S4	Pre-set Inspection	S32
Tapered Thread Ports	S6	Pre-set Using EO-Karrymat, Hydra-Tool or Hyferset	S32
Tapered Thread Port Assembly	S7	Installation	S33
Flange Ports	S8	Re-assembly with Replacement of Sealing Ring (DOZ)	S33
Troubleshooting Port End Connections	S9	EO-2 Troubleshooting Guide	S33
Tube End Assembly	S12	24° Flareless Bite	S34
Tube End Preparation	S12	Bulkhead Locknut Assembly	S35
Seal-Lok O-Ring Face Seal Fittings and UPTC Assembly	S13	Pipe Swivel Assembly	S35
Sleeve Attachment	S13	Routing and Clamping	S36
Flanging	S13	Routing of Lines	S36
Brazing	S16	Tube Clamping	S37
Final Installation	S17	Layout Data for Tube, Pipe and Hose Clamps	
Seal-Lok Troubleshooting Guide	S19	Standard (Inch) and Series A (Metric)	S37
Triple-Lok 37° Flare Fittings	S20	Heavy Series (Inch) and Series C (Metric)	S38
Flaring	S20	Twin Series (Inch) and Series B (Metric)	S38
Installation	S21	Tools for Tube Bending	S39
Triple-Lok Troubleshooting Guide	S22	Mandrel Bending Tools	S39
Ferulok Flareless Bite Type Fittings	S23	Plumbing and Assembly Hints	S40
Ferrule Pre-set	S23		
Ferulok Troubleshooting Guide	S25		
24° Flareless Bite	S26		
Intru-Lok Flareless Bite Type Fittings	S27		
Cutting, Deburring and Cleaning	S27		
Installation	S27		
Remake	S27		
Intru-Lok Troubleshooting Guide	S27		
EO Metric Bite Type Fittings	S28		
Pre-set of Progressive Ring	S28		
Pre-set Using the Fitting Body or Hardened Pre-assembly Tool	S28		
Pre-set Inspection	S29		
Pre-set Using EO-Karrymat, Hydra-Tool or Hyferset	S29		
Installation	S29		
Steps for Proper Assembly of Support Sleeve (VH)	S30		
EO Troubleshooting Guide	S31		



Port End Assembly

The three common types of port ends used in the United States with tube fittings, pipe fittings and hose fittings are:

- 1) Parallel thread
- 2) Tapered Thread
- 3) Flanges

Parallel Thread Ports

Unlike tapered threads, parallel thread ports do not require sealing by the threads. The seal is obtained by other means, typically an elastomeric seal. When assembled properly, parallel thread ports provide the best leak-free port connection available.

Parker tube fittings are available with several types of parallel thread port studs (ends):

- SAE straight threads (SAE J1926 / ISO 11926)
- ISO (ISO 6149)
- JIS (JIS B2351)
- BSPP flat face (ISO 1179)
- DIN Metric flat face (ISO 9974).

The SAE straight thread, ISO 6149 and JIS B2351 ports are all of similar design. The male end is fitted with an O-ring. On assembly, the O-ring is firmly sandwiched between the angular sealing surface of the female port, the male end undercut, and the shoulder or back-up washer of the male end. Sealing is thus made possible and maintained by the O-ring compression, which results from the sandwiching of the O-ring in the cavity as shown in Fig. S1. The straight threads do not offer sealing action; they provide the resistance (holding power) for service pressure. Port dimensions for SAE and ISO 6149 ports are given on pages T32 and T33 respectively. For JIS B2351 dimensions, please contact the Tube Fittings Division.

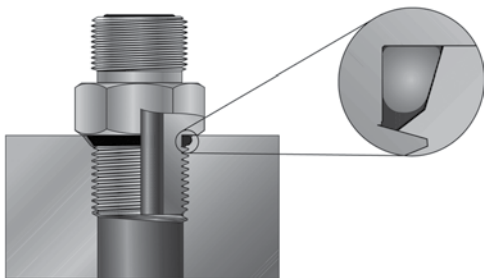


Fig. S1 – SAE / ISO / JIS B2351 Straight Thread Port O-Ring Upon Assembly

The SAE straight thread port is the same as MS 16142. **It is also similar to, but dimensionally not the same as, MS 33649 and AND 10050, and thus not interchangeable with them.** Therefore, it is not recommended to use fittings designed for SAE straight thread ports in MS 33649 and AND 10050 ports.

With the BSPP and metric flat face port ends, the sealing actually takes place on the top surface (spot face) of the port. Port dimensions can be found on pages T35 and T36 respectively. There are several sealing methods available for these ports. Port studs with type "E" sealing utilize Parker's EOlastic seal

(ED) (see Fig. S2) and are recommended for higher pressures than the other types. Types "G" and "H" use an O-ring that is supported on the outside by a removable retaining ring (see Fig. S3). Type B (cutting face) is designed with a relatively sharp ridge of material that seals by coining the flat face of the female port (see Fig. S4). A fourth sealing method uses a bonded seal which consists of a metal ring with an elastomer bonded to the inside surface (often referred to as Dowty® seal) (see Fig. S5).

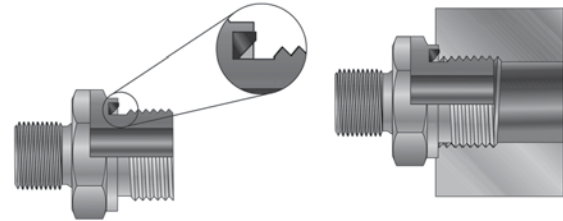


Fig. S2 – EOlastic Seal, Type E

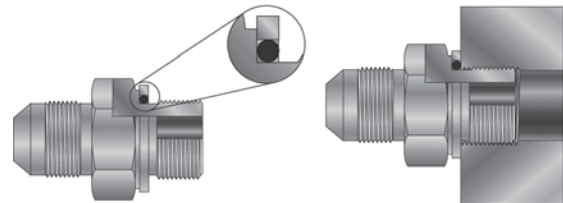


Fig. S3 – O-Ring with Retaining Ring, Types G & H

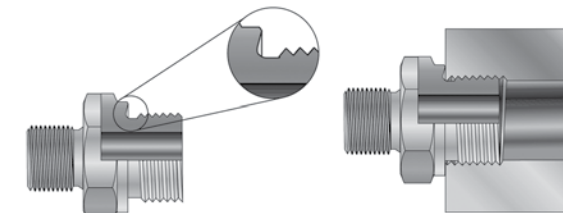


Fig. S4 – Cutting Face, Type B

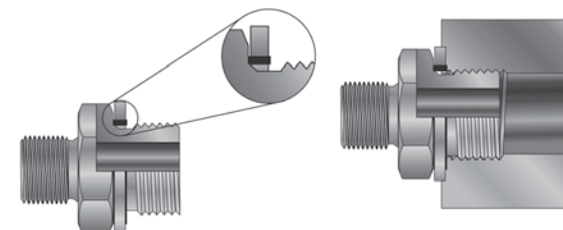


Fig. S5 – Bonded Seal

TABLE OF CONTENTS

SECTION TABLE OF CONTENTS

S

TABLE OF CONTENTS

SECTION TABLE OF CONTENTS

Counterbores and taps used to machine the various parallel thread ports can be found in section R.

For assembly purposes, there are two main categories of parallel port ends: adjustable and non-adjustable. Adjustable port ends are commonly found on shaped fittings to allow for proper orientation of the fitting. Besides the elastomeric seal, adjustable port ends are assembled with a locknut and a back-up washer as shown in Fig. S6. Non-adjustable port ends are found on straight fittings.

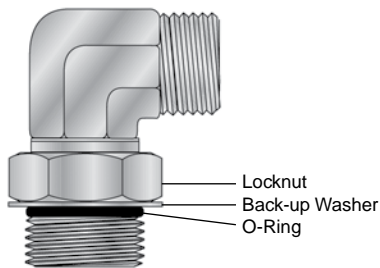


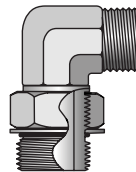
Fig.S6 – Adjustable Port End Assembly

The general assembly procedure for all adjustable parallel thread port ends is the same. Likewise, the assembly procedure is the same for all non-adjustable parallel thread port ends.

Adjustable Port End Assembly

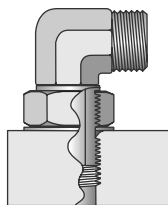
1. Inspect components to ensure that male and female port threads and sealing surfaces are free of burrs, nicks and scratches, or any foreign material.
2. If O-ring or seal is not pre-installed to fitting male port end, install proper size O-ring or seal, taking care not to damage it.
3. Lubricate O-ring with light coat of system fluid or a compatible lubricant to help the O-ring slide smoothly into the port and avoid damage.
4. Back off lock nut as far as possible. Make sure back-up washer is not loose and is pushed up as far as possible.

Locknut Completely Backed-Off



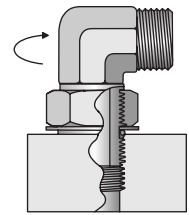
Step 4

5. Screw fitting into port until the back-up washer or the retaining ring contacts face of the port. Light wrenching may be necessary. **Over tightening may damage washer.** (This potential damage was eliminated with Parker's Robust Port)

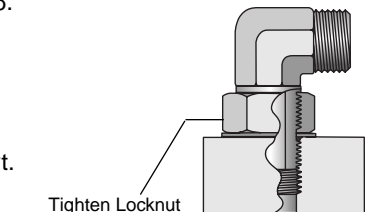


Step 5

6. To align the tube end of the fitting to accept incoming tube or hose assembly, unscrew the fitting by the required amount, but not more than one full turn.
7. Using two wrenches, hold fitting in desired position and tighten locknut to the proper torque value from the appropriate table located on pages S5 - S6.
8. Inspect to ensure that O-ring is not pinched and that washer is seated flat on face of port.



Step 6



Steps 7 and 8

Non-adjustable Port End Assembly

1. Inspect components to ensure that male and female port threads and sealing surfaces are free of burrs, nicks, and scratches, or any foreign material.
2. If O-ring or seal is not pre-installed to fitting male port end, install proper size O-ring or seal, taking care not to damage it.
3. Lubricate O-ring with light coating of system fluid or a compatible lubricant to help the O-ring slide past the port entrance corner and avoid damaging it.
4. Screw fitting into port and tighten to proper torque from the appropriate table located on pages S5 - S6.

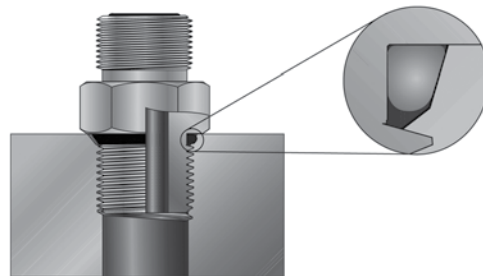


Fig. S7 — Non-Adjustable Port End Assembly

SAE Straight Thread Port Assembly (SAE J1926)

SAE Dash Size	Thread Size UN/UNF	Assembly Torque (+10% -0)											
		Non-Adjustables				Adjustables				Plugs			
		Seal-Lok (Heavy Duty SAE J1926-2)		Triple-Lok Ferulok Adapters (Light Duty SAE J1926-3)		Seal-Lok (Heavy Duty SAE J1926-2)		Triple-Lok Ferulok Adapters (Light Duty SAE J1926-3)		HP50N-S (Light Duty SAE J1926-3)		P50N-S (Light Duty SAE J1926-3)	
		ft.lbs. (in. lbs)	N-m	ft.lbs. (in. lbs)	N-m	ft.lbs. (in. lbs)	N-m	ft.lbs. (in. lbs)	N-m	ft.lbs. (in. lbs)	N-m	ft.lbs. (in. lbs)	N-m
2	5/16-24	—	—	(85)	10	—	—	(60)	7	(60)	7	(85)	10
3	3/8-24	—	—	(155)	18	—	—	(100)	11	(100)	11	(155)	18
4	7/16-20	(310)	35	(260)	29	(180)	20	(180)	20	(180)	20	(260)	29
5	1/2-20	(360)	41	(280)	32	(360)	41	(250)	28	(250)	28	(280)	32
6	9/16-18	(420)	47	(350)	40	(420)	47	(350)	40	(350)	40	(350)	40
8	3/4-16	(720)	81	(620)	70	(720)	81	(620)	70	(620)	70	(620)	70
10	7/8-14	100	136	85	115	100	136	85	115	85	115	85	115
12	1 1/16-12	135	183	135	183	135	183	135	183	135	183	135	183
14	1 3/16-12	175	237	175	237	175	237	175	237	175	237	175	237
16	1 5/16-12	200	271	200	271	200	271	200	271	200	271	200	271
20	1 5/8-12	250	339	250	339	250	339	250	339	250	339	250	339
24	1 7/8-12	305	414	305	414	305	414	305	414	305	414	305	414
32	2 1/2-12	375	508	375	508	375	508	375	508	375	508	375	508

Notes: Lubricate threads before assembly. Values in chart are for plated steel fittings in steel ports. For stainless steel fittings, use the upper limit of torque range. For brass and aluminum, decrease torque value by 35%.

Table S1 – SAE J1926 Straight Thread Port Assembly Torques

BSPP (Thread G) Port Assembly (ISO 1179 / DIN 3852-2)

Series	Tube O.D.	BSPP Thread G Size	Assembly Torque Nm +10% -0								
			Straight Male Stud Fittings			Non-Return Valves RHV / RHZ	Banjo Fittings		Plugs VSTI-ED	Straight and Adjustable Fittings	
			Form A for Sealing Washer	Form B with Cutting Face	Form E with ED-Sealing	Form E with ED-Sealing	WH / TH	SWVE	Form E with ED-Sealing	O-Ring with Retaining Ring and Bonded Washer	
	6	1/8 - 28	9	18	18	18	18	18	18	13	18
	8	1/4 - 19	35	35	35	35	45	40	30	30	35
	10	1/4 - 19	35	35	35	35	45	40	30	30	35
L	12	3/8 - 19	45	70	70	50	70	65	60	60	70
	15	1/2 - 14	65	140	90	85	120	90	80	80	90
	18	1/2 - 14	65	140	90	85	120	90	80	80	90
	22	3/4 - 14	90	180	180	140	230	125	140	140	180
	28	1 - 11	150	330	310	190	320	—	200	310	310
	35	1 1/4 - 11	240	540	450	360	540	—	400	450	450
	42	1 1/2 - 11	290	630	540	540	700	—	450	540	540
S	6	1/4 - 19	35	55	40	45	45	40	—	—	40
	8	1/4 - 19	35	55	40	45	45	40	—	—	40
	10	3/8 - 19	45	90	80	60	70	65	—	—	60
	12	3/8 - 19	45	90	80	60	70	65	—	—	60
	14	1/2 - 14	65	150	115	145	120	90	—	—	90
	16	1/2 - 14	65	130	115	100	120	90	—	—	90
	20	3/4 - 14	90	270	180	145	230	125	—	—	180
	25	1 - 11	150	340	310	260	320	—	—	—	310
	30	1 1/4 - 11	240	540	450	360	540	—	—	—	450
	38	1 1/2 - 11	290	700	540	540	700	—	—	—	540

Note: Lubricate threads before assembly! Tightening torques are for steel fittings assembled in steel components. Values in chart are for steel fittings in steel ports. For stainless steel fittings, please use the upper limit of torque range. For brass (and other soft metals), decrease torque value by 35%.

Table S2 – Assembly Torques for ISO 1179-1 / DIN 3852-2 Port

Dimensions and pressures for reference only, subject to change.

TABLE OF CONTENTS
SECTION TABLE OF CONTENTS

S



Metric (ISO Thread M) Port Assembly (ISO 9974-1 / DIN 3852-1)

Series	Tube O.D.	Metric Thread M Size	Assembly Torque Nm +10% -0							
			Straight Male Stud Fittings			Non-Return Valves RHV / RHZ	Banjo Fittings		Plugs VSTI-ED	Straight and Adjustable Fittings
			Form A for Sealing Washer	Form B with Cutting Face	Form E with ED-Sealing	Form E with ED-Sealing	WH / TH	SWVE	Form E with ED-Sealing	O-Ring with Retaining Ring
L	6	M 10 x 1	9	18	18	18	18	18	12	18
	8	M 12 x 1.5	20	30	25	25	45	35	25	25
	10	M 14 x 1.5	35	45	45	35	55	50	35	40
	12	M 16 x 1.5	45	65	55	50	80	60	55	55
	15	M 18 x 1.5	55	80	70	70	100	80	65	70
	18	M 22 x 1.5	65	140	125	125	140	120	90	90
	22	M 27 x 2	90	190	180	145	320	130	135	180
S	28	M 33 x 2	150	340	310	210	360	—	225	310
	35	M 42 x 2	240	500	450	360	540	—	360	450
	42	M 48 x 2	290	630	540	540	700	—	360	540
	6	M 12 x 1.5	20	35	35	35	45	35	—	35
	8	M 14 x 1.5	35	55	45	45	55	50	—	55
	10	M 16 x 1.5	45	70	70	55	80	60	—	70
	12	M 18 x 1.5	55	110	90	70	100	80	—	90
S	14	M 20 x 1.5	55	150	125	100	125	110	80	125
	16	M 22 x 1.5	65	170	135	125	135	120	—	135
	20	M 27 x 2	90	270	180	135	320	135	—	180
	25	M 33 x 2	150	410	310	210	360	—	—	310
	30	M 42 x 2	240	540	450	360	540	—	—	450
	38	M 48 x 2	290	700	540	540	700	—	—	540

Note: Lubricate threads before assembly! Values in chart are for steel fittings in steel ports. For stainless steel fittings, please use the upper limit of torque range. For brass, aluminum (and other soft metals), decrease torque value by 35%.

Table S3 – Assembly Torques for ISO 9974-1 / DIN 3852-1 Port

Metric ISO Port Assembly (ISO 6149/DIN 3852-3)

Metric Thread M Size	Assembly Torque (+10% -0) ³⁾			
	ISO 6149-2 Stud Ends (S-Series) (Seal-Lok, EO & VSTI-OR Plugs)		ISO 6149-3 Stud Ends (L-Series) (Triple-Lok, EO, Ferulok & Pipe Adapters)	
	N.m.	ft. lbs.	N.m.	ft. lbs.
M8x1	10	7.5	8	6
M10x1	20	15	15	11
M12x1.5	35	26	25	18
M14x1.5	45	33	35	26
M16x1.5	55	41	40	30
M18x1.5	70	52	45	33
M20x1.5 ⁴⁾	80	59	—	—
M22x1.5	100	74	60	44
M27x2	170	125	100	74
M30x2 ¹⁾	235	175	130	95
M33x2	310	230	160	120
M38x2 ²⁾	320	235	185	135
M42x2	330	245	210	155
M48x2	420	310	260	190
M60x2	500	370	315	230

- M30X2 will be added to ISO 6149 standards at next revision.
- M38X2 is not covered in ISO 6149 standards.
- These torques are for steel fittings, assembled lubricated, for brass (and other soft metals), decrease torque value by 35%.
- For cartridge valves only.

Table S4 – ISO 6149 / DIN 3852-3 Port Assembly Torques

Tapered Thread Ports

Tapered thread ports include NPTF, BSPT and metric taper. The tapered threads in these ports serve two functions: 1) to hold the fitting in place while under pressure and 2) to serve as the primary seal. The seal for NPTF threads is created by the metal-to-metal contact between the mating roots and crests of the male and female threads. With all other tapered threads, there is not always a contact at the roots and crests, but the spiral gap there is small enough for a sealant to fill and provide a seal.

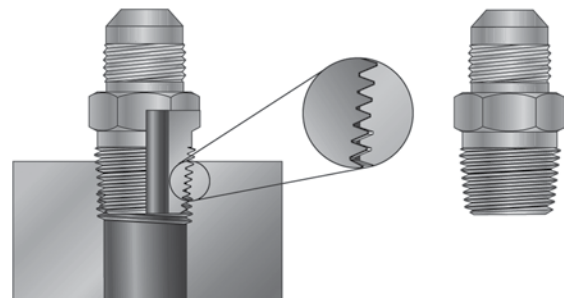


Fig. S8 – Tapered Thread Port

Dimensions and pressures for reference only, subject to change.



The variety of thread forms available under taper threads include:

NPT – American Standard Taper Pipe Thread (ANSI B1.20.1).

NPTF – Dryseal American Standard Taper Pipe Thread (SAE J476, ANSI B1.20.3).

BSPT or JIS “PT” – British Standard Pipe, Tapered (BS21, JIS B 0203, ISO 7), also known as “R” for male and “Rc” for female.

M-Keg – Metric taper threads (DIN 158).

The vast majority of Parker Tube Fittings Division’s standard pipe thread fittings are machined with the NPTF thread form. NPTF thread is also referred to as Dryseal Pipe Thread.

The full thread profile contact of NPTF threads is designed to give the tapered threads self-sealing ability without thread sealant. However, variations in condition of mating threads, fitting and port materials, assembly procedures and operating conditions make self-sealing highly improbable. Some type of thread sealant is, therefore, required to achieve proper seal and, in some cases, additional lubricity to prevent galling.

Types of Sealant/Lubricant

Sealant/Lubricants assist in sealing and provide lubrication during assembly, reducing the potential for galling. Pipe thread sealants are available in various forms such as dry pre-applied, tape, paste and anaerobic liquid.

Pre-applied sealants, such as “Vibraseal” (registered trade-mark of Loctite Corporation) and powdered PTFE are usually applied to connectors by the manufacturer. Connectors with some of these sealants may be remade a few times without needing additional sealant. Vibraseal may also help reduce loosening due to vibration.

PTFE tape, if not applied properly, can contribute to system contamination during assembly and installation. In addition, because of PTFE’s high lubricity, fittings can be more easily over tightened; and it does not offer much resistance to loosening due to vibration.

Paste sealants can also contribute to system contamination, if not applied properly. They are also messy to work with; and some types require a cure period after component installation, prior to system start up.

Anaerobic liquids are available from several manufacturers and perform sealing as well as thread locking functions. They are applied to the connectors by the user and require a cure period prior to system start up. Some are soluble in common hydraulic fluids and will not contaminate the system. For proper performance they need to be applied to clean and dry components, carefully following the manufacturer’s directions.

Tapered Thread Port Assembly

The proper method of assembling tapered threaded connectors is to assemble them finger tight and then wrench tighten further to the specified number of turns from finger tight (T.F.F.T.) given in Table S5. The following assembly procedure is recommended to minimize the risk of leakage and/or damage to components.

1. Inspect components to ensure that male and female port threads and sealing surfaces are free of burrs, nicks and scratches, or any foreign material.
2. Apply sealant/lubricant to male pipe threads if not pre-applied. For stainless steel fittings, the use of Parker Thread-mate sealant/lubricant is strongly recommended. (Pre-applied dry sealants are preferred over other sealants). With any sealant, the first one to two threads should be left uncovered to avoid system contamination. If PTFE tape is used it should be wrapped 1-1/2 to 2 turns in clockwise direction when viewed from the pipe thread end.
Caution: More than two turns of tape may cause distortion or cracking of the port.
3. Screw the connector into the port to the finger tight position.
4. Wrench tighten the connector to the appropriate T.F.F.T. values shown in Table S5, making sure that the tube end of a shaped connector is aligned to receive the incoming tube or hose assembly. **Never back off (loosen) pipe threaded connectors to achieve alignment.**
5. If leakage persists after following the above steps, check for damaged threads and total number of threads engaged.

If threads on the fitting are badly nicked or galled, replace the fitting. If port threads are damaged, re-tap, if possible, or replace the component. If the port is cracked, replace the component.

Normally, the total number of tapered threads engaged should be between 3-1/2 and 6. Any number outside of this range may indicate either under or over tightening of the joint or out of tolerance threads. If the joint is under tightened, tighten it further but no more than one full turn. If it is over tightened, check both threads, and replace the part which has out-of-tolerance threads.

As a general rule, pipe fittings with tapered threads should not be assembled to a specific torque because the torque required for a reliable joint varies with thread quality, port and fitting materials, sealant used, and other factors. Where many of these factors are well-controlled, such as particular jobs on an assembly floor, a torque range that produces the desired results may be determined by test and used in lieu of turns count for proper joint assembly.

Tapered Pipe Thread Size		T.F.F.T.
BSPT	NPTF	
1/8-28	1/8-27	2 - 3
1/4-19	1/4-18	2 - 3
3/8-19	3/8-18	2 - 3
1/2-14	1/2-14	2 - 3
3/4-14	3/4-14	2 - 3
1-11	1-11 1/2	1.5 - 2.5
1 1/4-11	1 1/4-11 1/2	1.5 - 2.5
1 1/2-11	1 1/2-11 1/2	1.5 - 2.5
2-11	2-11 1/2	1.5 - 2.5

Table S5 – Assembly Turns From Finger Tight (T.F.F.T) Values For Steel, Stainless Steel and Brass Pipe Fittings

Dimensions and pressures for reference only, subject to change.



Flange Ports

Large threaded port connections, such as SAE straight thread, require very high torque to assemble. This makes assembly very difficult, especially where wrench clearance is limited. Split flange connections solve this problem by dividing the hydraulic load among four bolts each requiring much less torque, smaller wrenches and smaller wrench clearance.

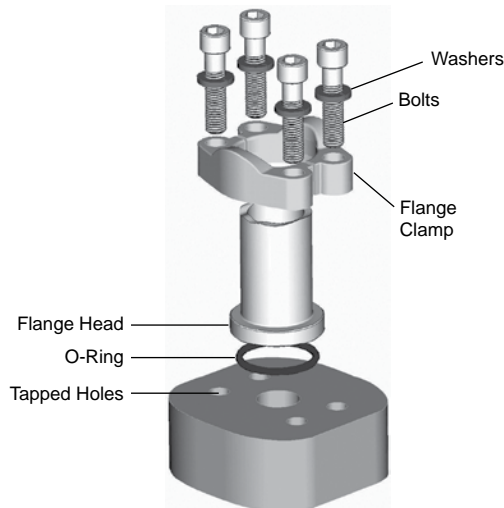


Fig. S9 – 4-Bolt Split Flange Components

There are two types of flange port connections:

- ISO 6162, Type 2
 - SAE Code 61 4-bolt split flange
 - SAE Code 62 4-bolt split flange
- ISO 6164

The 4-Bolt Split Flange consists of four main components:

- A body (flange head)
- An O-ring
- One “captive” or two “split” flange clamps
- Four bolts and washer

The four-bolt port is simply a circular opening (flow passage) surrounded by four tapped holes in a certain pattern for acceptance of the flange clamping bolts. The flat surface of the port compresses the O-ring contained in the groove in the flange head when the clamp bolts are torqued. In some instances, the groove is in the port and not in the flange head. The bolts, through the clamp halves, clamp down the flange head onto the flat surface of the port compressing and trapping the O-ring in the groove and leaving no gap for it to extrude under pressure. The hydraulic pressure is thus sealed by the compressed O-ring as long as the bolts are tightened enough to maintain solid metal to metal contact between the flange head at the outside diameter of the O-ring and the top of the port.

Flange Port Assembly

The steps to properly assemble the flange port clamping bolts are:

1. Inspect components to ensure that male and female port threads and sealing surfaces are free of burrs, nicks and scratches, or any foreign material.
2. Lubricate the O-ring.

3. Position flange and clamp halves.
4. Place lock washers on bolts and insert through clamp halves.
5. Hand tighten bolts.
6. Torque bolts in diagonal sequence (see Fig. S10) in small increments to the appropriate torque level listed in Table S6 or S7 below.

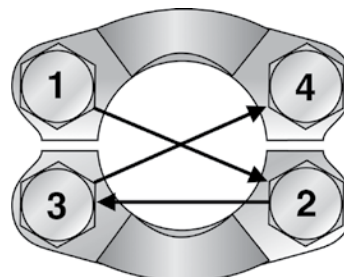


Fig. S10 – Flange Bolt Tightening Sequence

Dash Size	Flange Size	Inch Bolt (J518)	+10% -0 Torque ft. lbs.	Metric Bolt (ISO 6162)	+10% -0 Torque N-m
8	1/2	5/16-18	17	M8	24
12	3/4	3/8-16	31	M10	50
16	1	3/8-16	31	M10	50
20	1-1/4	7/16-14	52	M10	50
24	1-1/2	1/2-13	77	M12	92
32	2	1/2-13	77	M12*	92
40	2-1/2	1/2-13	77	M12	92
48	3	5/8-11	155	M16	210
56	3-1/2	5/8-11	155	M16	210
64	4	5/8-11	155	M16	210
80	5	5/8-11	155	M16	210

* Does not meet ISO 6162 specification.

Table S6 – Code 61 Flange Recommended Bolt Torque

Dash Size	Flange Size	Inch Bolt (J518)	+10% -0 Torque ft. lbs.	Metric Bolt (ISO 6162)	+10% -0 Torque N-m
8	1/2	5/16-18	17	M8	24
12	3/4	3/8-16	31	M10	50
16	1	7/16-14	52	M12	92
20	1-1/4	1/2-13	77	M14*	130
24	1-1/2	5/8-11	155	M16	210
32	2	3/4-10	265	M20	400

* Does not meet ISO 6162 specification.

Table S7 – Code 62 Flange Recommended Bolt Torque

Socket Screw Bolt Circle (LK)	Socket Head Cap Screws	Tightening Torques N-m
LK35	M6	10
LK40	M6	10
LK55	M8	25

Table S8 – Hydraulic Flange Recommended Bolt Torque

* In general, variances of torque for soft metal ports/manifolds (ie: aluminum block - 66% of specified torque)

Dimensions and pressures for reference only, subject to change.

TABLE OF CONTENTS

SECTION TABLE OF CONTENTS

Troubleshooting Port End Connections

TABLE
OF
CONTENTS

SECTION
TABLE OF
CONTENTS

60° Cone (Metric, BSPP and NPSM)

CONDITION	PROBABLE CAUSE(S)	RECOMMENDATION
End of swivel nut contacts hex shoulder of adapter before cone and ball nose tightens	<ul style="list-style-type: none"> Wrong combination of swivel nut and adapter 	<ul style="list-style-type: none"> Ensure that components are to the same specification (even with the same type, there are different designs for 60° cone fittings)
Thread engagement seems adequate and swivel nut is tight but leakage still occurs	<ul style="list-style-type: none"> Scratches or nicks on sealing surface Chatter marks on sealing surface 	<ul style="list-style-type: none"> Replace components. These fittings depend on metal-to-metal seal and require smooth mating surfaces to seal
There is leakage from the joint and the swivel nut is loose	<ul style="list-style-type: none"> Inadequate make-up torque 	<ul style="list-style-type: none"> Use proper torque to create a seal as well as prevent vibration loosening
Swivel nut tightens, cone is tight but connection still leaks	<ul style="list-style-type: none"> Inadequate or no chamfer in adapter 	<ul style="list-style-type: none"> Use components with proper chamfer (very common occurrence with NPTF/NPSM 60° cone fittings). Male pipe end must have chamfer for proper sealing. Not all male pipe ends have chamfer as standard

Tapered Thread (including BSPT, NPT and metric taper)

CONDITION	PROBABLE CAUSE(S)	RECOMMENDATION
Thread galling	<ul style="list-style-type: none"> Most common in stainless steel, caused by friction and lack of lubricant 	<ul style="list-style-type: none"> Replace fitting and apply proper thread sealant/lubricant to replacement fitting and tighten to appropriate TFFT
Fitting leaks, even after proper tightening	<ul style="list-style-type: none"> Sealant omitted or inadequately applied Damaged or cracked threads Cracked port Thread mixing of BSPT and NPT threads 	<ul style="list-style-type: none"> Re-apply sealant to appropriate TFFT and re-tighten Replace fitting Replace component Determine port thread type and replace fitting with matching thread type
Insufficient thread engagement (3 to 6 threads of engagement required)	<ul style="list-style-type: none"> Quality problem with port or adapter Too much thread sealant (tape) 	<ul style="list-style-type: none"> Have port and adapter thread inspected; replace faulty parts Remove all thread sealant and re-apply 1 to 2 layers of tape
Too much thread engagement (more than recommended 3 to 6 threads)	<ul style="list-style-type: none"> Typically port or adapter machining or wear problem, or port could be cracked due to excessive torque 	<ul style="list-style-type: none"> Inspect port and adapter for proper tolerance or wear, replace faulty parts, retighten to appropriate TFFT
Poor-quality threads or damaged/nicked threads	<ul style="list-style-type: none"> Larger sizes are more prone to having nicked threads due to handling damage 	<ul style="list-style-type: none"> Replace fitting with threads that are free of scratches and nicks

S

Dimensions and pressures for reference only, subject to change.

Troubleshooting Port End Connections

Parallel (SAE, BSPP and metric)



CONDITION	PROBABLE CAUSE(S)	RECOMMENDATION
Washer is too loose (moves by its own weight or rocks too much on the undercut)	<ul style="list-style-type: none"> Washer damaged 	<ul style="list-style-type: none"> Replace fitting
Fitting threads are distorted	<ul style="list-style-type: none"> Over-torqued Mixed threads 	<ul style="list-style-type: none"> Replace fitting and tighten to proper torque Determine correct thread type
Several scratches or nicks on the port face	<ul style="list-style-type: none"> Port face contaminated (dirty) 	<ul style="list-style-type: none"> Reface the port
Spot face of port is smaller than washer diameter	<ul style="list-style-type: none"> Improper port tool was used Wrong fitting selected for port 	<ul style="list-style-type: none"> Reface the port Select a proper fitting
Port threads are distorted (yielded)	<ul style="list-style-type: none"> Fitting over-torqued 	<ul style="list-style-type: none"> Replace component
Leakage persists after locknut has been torqued	<ul style="list-style-type: none"> Damaged O-ring Damaged washer Improper assembly 	<ul style="list-style-type: none"> Replace O-ring with new quality O-ring (90 durometer) and reconnect fitting to proper torque Replace fitting Follow proper assembly procedure
Washer distorted, allowing opportunity for O-ring to extrude	<ul style="list-style-type: none"> Exposed upper thread forced washer into port during assembly (over-torquing makes this more prevalent) 	<ul style="list-style-type: none"> Replace fitting, using proper installation techniques for adjustable port ends

Dimensions and pressures for reference only, subject to change.

Troubleshooting Port End Connections

Flange (i.e., ISO 6162 4-Bolt)

TABLE
 OF
 CONTENTS

SECTION
 TABLE OF
 CONTENTS

CONDITION	PROBABLE CAUSE(S)	RECOMMENDATION
Missing or improper O-ring	<ul style="list-style-type: none"> • Assembly/re-assembly oversight 	<ul style="list-style-type: none"> • Replace with proper O-ring and re-tighten connection using incremental alternating tightening procedure
O-ring pinched or extruded	<ul style="list-style-type: none"> • Improper tightening procedure 	<ul style="list-style-type: none"> • Replace O-ring and re-tighten connection using incremental alternating tightening procedure
Evidence of yielded or cracked flange head, tube or hose end	<ul style="list-style-type: none"> • Misaligned tube or hose connection 	<ul style="list-style-type: none"> • Re-bend or re-route hose/tube lines to eliminate misalignment
Components do not mate or gap is too large	<ul style="list-style-type: none"> • Proprietary flange or pressure series matching problem 	<ul style="list-style-type: none"> • Properly identify all components—most proprietary flanges use standard Code 61/62 bolt patterns and threads but are not usually interchangeable
Port has severe scratches or nicks in seal area	<ul style="list-style-type: none"> • Mishandling or abuse 	<ul style="list-style-type: none"> • Resurface the port to remove scratches and nicks
Clamp halves are bent	<ul style="list-style-type: none"> • Over-pressurization or over-torque 	<ul style="list-style-type: none"> • Replace clamp halves and tighten to proper torque
Bolts are bent	<ul style="list-style-type: none"> • Bolts are too weak or over-torqued 	<ul style="list-style-type: none"> • Replace bolts with grade 5 or better; retighten to proper torque

S

Dimensions and pressures for reference only, subject to change.

Tube End Assembly

The assembly of the tube end consists of the following two steps:

1. Tube end preparation (cutting, deburring and cleaning)
2. Assembly and installation

Tube End Preparation

Tube end preparation is a very critical step to assure the integrity of a tube assembly. Failure to properly perform this function can result in leakage. The three steps in proper tube end preparation are: cutting, deburring and cleaning.

Cutting

Cut tube reasonably square (within $\pm 1^\circ$) using a circular toothed cut-off saw (see Fig. S11), or a hacksaw with a fine tooth blade guided by a Tru-Cut Saw Guide (shown in Fig. S12) or other mitre-type saw guide.

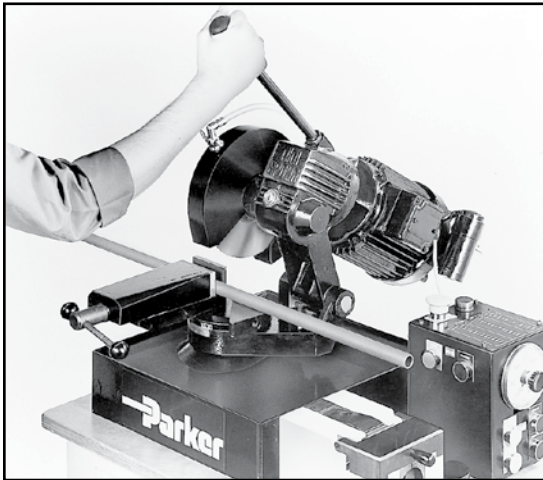


Fig. S11 – Cut-off Saw on Parker's TP432 or TP1025 Tube Preparation Center

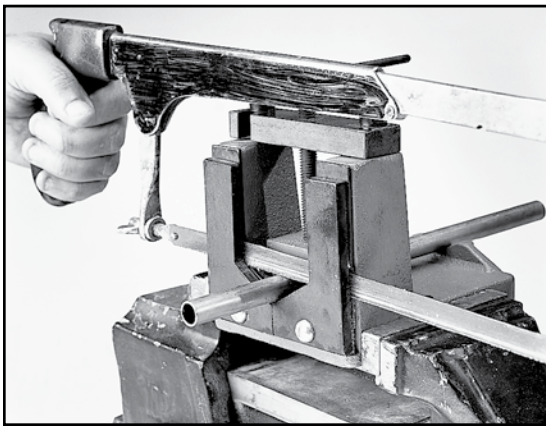


Fig. S12– Parker's Tru-Kut Sawing Vise used with hacksaw

A tube cutter may be used with soft tube such as copper and aluminum. It is not recommended for steel and stainless steel tube because it creates a large burr on the I.D., which is difficult to remove and creates flow restriction. Furthermore, if the tube needs to be flared or flanged, the build up on the ID can compromise the sealing surface. For a steel or stainless steel tube application, Fig. S13 illustrates a proper cut and an improper cut (the improper cut was performed by a tube cutter).

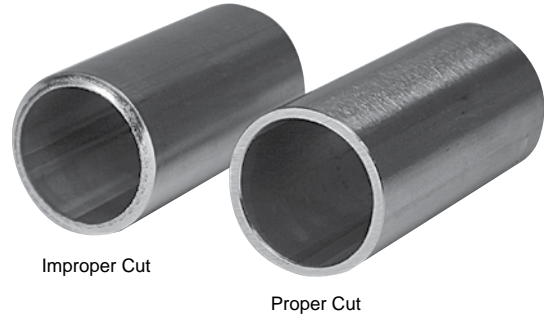


Fig. S13 – Samples of improper and proper cuts on steel tube

A square cut is essential to assure a leak-free connection. The following illustrations depict what will result from an uneven cut.

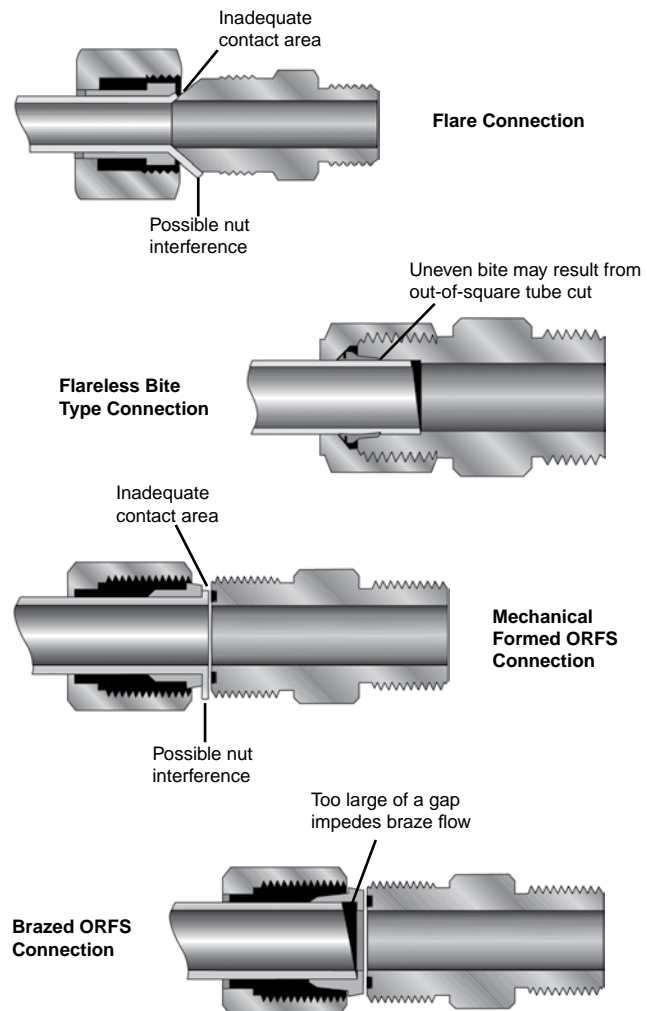


Fig. S14– Results of Uneven Tube Cuts

TABLE OF CONTENTS

SECTION TABLE OF CONTENTS

Deburring

Lightly deburr the I.D. and O.D. of the tube end to remove burrs and sharp edges. Use the In-Ex deburring tool or power deburring tool (shown on page R22), or emery paper if using tube cutter (for soft tube) or hacksaw. Use front mounted deburring tools if using TP432 or TP1025 tube preparation center found on page R55.

Note: Point tube end downward during deburring to keep chips from entering the tube.

Cleaning

Remove metal chips from I.D. with a brush or compressed air. Wipe the I.D. and the O.D. of the deburred tube end with a clean rag. Debris present in the tube end can result in system contamination or can get embedded into the flange or flare, causing imperfections that are potential leak paths.

Seal-Lok O-Ring Face Seal Fittings

The proper assembly of the Seal-Lok fitting requires several steps, each important in guaranteeing a leak-free connection and a long service life:

1. Cutting, deburring and cleaning the tube
2. Sleeve Attachment
3. Inspection of sleeve attachment
4. Final installation

The first step of cutting, deburring and cleaning has been covered in a previous section (see page S12).

For recommended minimum and maximum tube wall thickness for Seal-Lok fittings, please refer to Table U3 and U4 on page U3.

Stainless seal lubricant is not necessary for assembly unless parts are washed or heated above 150°. The light wax coating will evaporate at that point.

Sleeve Attachment

Attaching the sleeve to the tube end is the next critical assembly step. This can be accomplished by two methods mechanically: (flanging) or brazing.

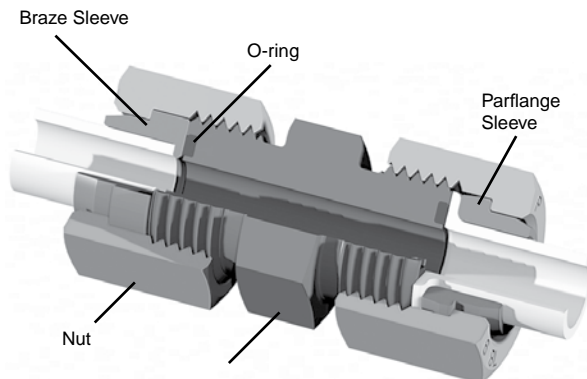


Fig. S15 – Seal-Lok Union cutaway with flanged and brazed assemblies

Flanging

The flanging method requires the use of an appropriate forming machine to create the flange or flat face on the tube end. Since the flat face of the flanged tube seals against the O-ring within the fitting groove, it is important that this surface be relatively smooth. Proper tube end preparation (cutting, deburring and cleaning) will help accomplish this goal.

The Parker Parflange® machines utilize an orbital cold forming process to produce a flat, smooth, rigidly supported 90° sealing surface on the tube end.

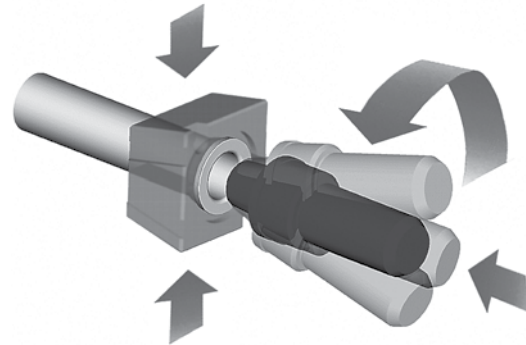


Fig. S16 – Parker's exclusive orbital spindle motion produces a perfect flange every time

Parker offers a bench mount model known as the Parflange 1025, shown in Fig. S17, as well as a more versatile, fully automated high speed models. For additional information on the Parflange machines and tooling, refer to section R of this catalog. For additional information on the fully automated models, please contact Parker Tube Fittings Division.

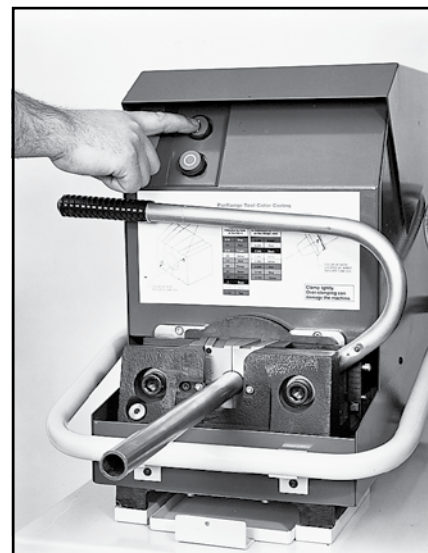


Fig. S17 – Parflange 1025 machine

Flanging Steps:

1. Determine the extra cut-off length required for the Parflange process by referring to Tables S9 and S10. (Each table is only a guide. Variations in tube wall thickness and inconsistency in quality of tube cut-off may affect actual dimensions. User should verify actual extra tube cut-off length with one or two flanges prior to large scale flanging.)
2. Select the proper tooling for the tube size. The tube OD, wall thickness and material must be known for proper selection. Refer to Table R6 on page R24 for flanging capability by Parflange machine and availability of tooling

3. With the sleeve properly positioned within the die set, place the die set into the die holder of the machine.
4. Insert the tube through the die opening until it comes in contact with the tube stop. Do not forget to position the tube nut over the tube in the proper orientation, especially if the other tube end has already been flanged, or the tube has sharp bends.
5. Flange the tube as shown in Figure S17.

Note: For more information on Parflange procedures, machines, etc., Contact Parker Tube Fittings Division.

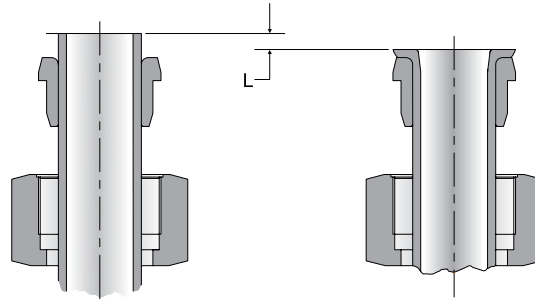


Fig. S18 – Extra cut-off length

Tube O.D. (in.)	Tube Wall Thickness – Inch										
	.028	.035	.049	.065	.083	.095	.109	.120	.134	.156	.188
1/4	3/16	13/64	7/32								
3/8		5/32	3/16	13/64	15/64	1/4					
1/2		9/64	9/64	3/16	13/64	9/32	19/64	19/64			
5/8			11/64	3/16	13/64	1/4	17/64	17/64			
3/4			11/64	3/16	7/32	7/32	1/4	17/64	9/32		
1				3/16	3/16	13/64	15/64	1/4	19/64		
1 1/4				11/64	3/16	13/64	15/64	1/4	19/64	19/64	21/64
1 1/2				13/64	15/64	15/64	1/4	17/64	19/64	23/64	3/8

Table S9 – Extra tube cut-off length guide for inch tube

Tube O.D. (in.)	Metric Tube Outside Diameter – (mm)								
	6	8	10	12	16	20	25	30	38
1.0	3/16	7/32	1/8	5/32	9/64				
	5.2	5.7	3.1	4.1	3.6				
1.5	17/64	15/64	13/64	7/32	11/64				
	6.7	5.9	5.1	5.4	4.2				
2.0			13/64	15/64	3/16	7/32	15/64	17/64	9/32
			5.3	6.1	4.9	5.4	6.1	6.6	7.2
2.5				17/64	7/32	15/64	1/4	19/64	
				6.7	5.5	6.1	6.4	7.6	
3.0					15/64	17/64	9/32	5/16	19/64
					5.8	6.7	7.2	7.9	7.7
3.5						17/64	19/64	21/64	
						6.9	7.5	8.5	
4.0						9/32	5/16	11/32	11/32
						7.2	8.0	8.6	8.7
5.0							11/32		3/8
							8.8		9.4

Table S10 – Extra tube cut-off length guide for metric tube

Dimensions and pressures for reference only, subject to change.

Another consideration prior to flanging is the minimum straight length to the start of a 90° bend. Table S11 provides this information.

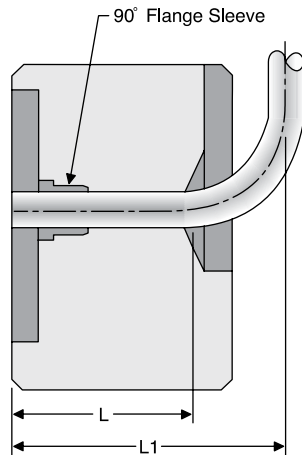


Fig. S19 – Minimum straight length to start of bend for 90° flanging

Tube O.D. Inch Sizes	Tube O.D. Metric Sizes	L*		L1**	
		(in.)	(mm)	(in.)	(mm)
1/4"	6	1 5/16	35	3 1/8	79
5/16"	8	1 5/16	35	3 5/32	80
3/8"	10	1 5/16	40	3 3/16	81
1/2"	12	1 3/8	40	3 1/4	82
	15	1 3/8	40	3 5/16	84
5/8"	16	1 1/2	41	3 5/16	84
	18	1 5/8	42	3 11/32	85
3/4"	20	1 3/4	50	3 3/8	86
	22	1 7/8	50	3 7/16	87
	25	1 7/8	50	3 1/2	89
1"	28	1 7/8	50	3 9/16	90
	30	1 7/8	50	3 19/32	91
1 1/4"	32	1 7/8	50	3 5/8	92
	35	2	50	3 11/16	94
1 1/2"	38	2	50	3 3/4	95

Table S11 – Minimum straight length to start of bend for 90° flanging

Notes:

- * L is the minimum straight length to the start of tube bend.
- ** L1 is the minimum centerline dimension necessary for 90° bent tube to clear the frame of the Parflange machine. In bending of the tubes, use radius blocks which will ensure that L1 dimensions are met or exceeded.

Flange Inspection

The flange should be inspected for proper diameter and sealing surface quality. Table S12 provides the flange diameters for the different sizes. The sleeve can also be used as a quick gauge of the flange diameter. Visually compare the flange diameter to the tapered surface located at the front end of the sleeve (right behind the flange). The large diameter and small diameters at each end of this surface serve as the maximum and minimum flange diameter limits, respectively.

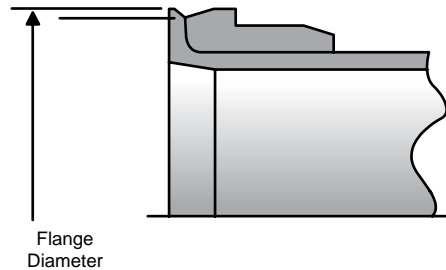


Fig. S20 — Flange diameter

Inch Tube O.D. (in.)	Metric Tube O.D. (mm)	Flange Diameter (in.)
1/4	6	.478 / .502
3/8	10	.594 / .620
1/2	12	.719 / .745
5/8	14, 15, 16	.875 / .923
3/4	18, 20	1.048 / 1.097
1	22, 25	1.298 / 1.347
1-1/4	28, 30, 32	1.549 / 1.597
1-1/2	38	1.861 / 1.910

Table S12 – Flange dimensions

TABLE OF CONTENTS

SECTION TABLE OF CONTENTS

S

Over-flanging will result in tube nut interference, as well as thinning of the flange tube end. Under-flanging reduces the contact area for sealing against the O-ring in the fitting.

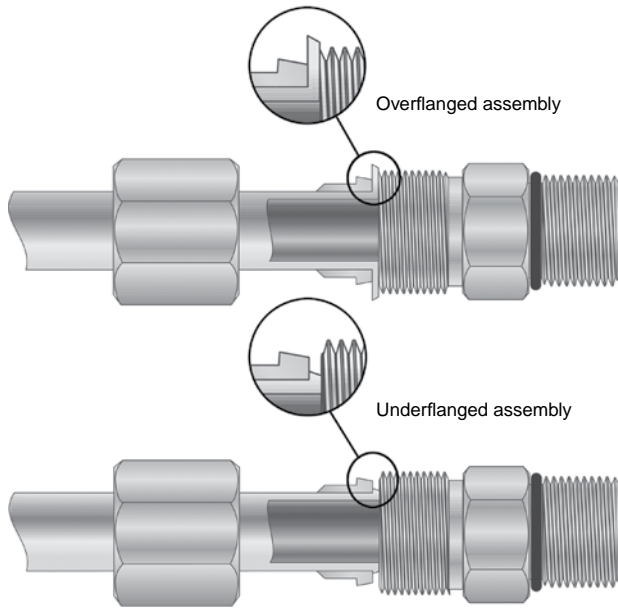


Fig. S21 – Overflanging and Underflanging

Advantages of Parflange process

There are numerous advantages to using the Parflange process over the braze or weld process:

- The Parflange process is several times faster than the brazing or welding methods. For instance, the 1025 model produce flanges at a rate of 9 to 12 times the speed of comparable induction brazing.
- The Parflange process does not require any special pre- or post-flange cleaning of the tube and sleeve.
- Unlike brazing, the Parflange process does not require any flux, braze alloy, post braze cleaner or rust inhibitor. An environmentally safe lubricant applied to the flanging pin is the only additive associated with the Parflange.
- The Parflange process is inherently safe. It does not require open flame or any form of heating. Additionally, there is no emission of hazardous fumes, as is typical with welding and brazing.
- The Parflange process uses only a fraction of the energy needed for welding or brazing.
- The Parflange process accommodates the use of plated components (i.e., tube and sleeve), thus eliminating the need to electroplate assemblies after fabrication.
- The Parflange process eliminates the potential for leaks at the braze or weld joint.
- The Parflange process produces a burnished sealing surface, typically much smoother than the 125 micro-inch requirement of SAE J1453.

Brazing

Brazing is the other method of attaching the sleeve to the tube end. This process can be accomplished by using a multi-flame torch, as shown in Fig. S22, or an induction brazing unit. (Note: multi-flame torches and induction brazing units are not available through Tube Fittings Division). During the heating process, the pre-formed braze ring or wire-fed filler material is melted between the tube O.D. and the sleeve I.D., creating a strong bond between the two.



Fig. S22 – Multi-flame torch brazing

Brazing Steps:

1. Determine the tube length allowance using Table S13.

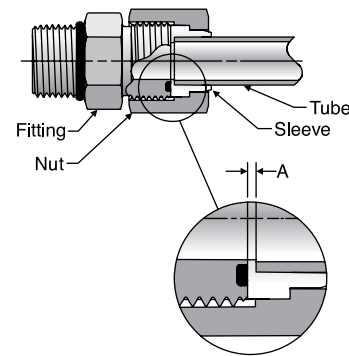


Fig. S23 – Tube length allowance

Nominal Tube O.D.		A (in.)
Inch	Metric	
1/4	6	0.04
3/8	8, 10	0.04
1/2	12	0.04
5/8	14, 15, 16	0.06
3/4	18, 20	0.06
1	22, 25	0.06
1 1/4	28, 30, 32	0.06
1 1/2	35, 38	0.06

Table S13 – Tube length allowance

Dimensions and pressures for reference only, subject to change.

TABLE OF CONTENTS

SECTION TABLE OF CONTENTS

TABLE OF CONTENTS

SECTION TABLE OF CONTENTS

- 2. Cleaning the tube end:** All oil and oxide build-up must be removed from the tube end for at least the length of the braze joint. Oil may be removed by using an oil-free solvent. Oxide build-up may be removed by pickling or by lightly sanding with an aluminum-free emery paper.
- 3. Fixturing the parts for brazing:** Care should be taken so the braze fixture allows the sleeve to settle and bottom on the tube completely during heating. Since the Seal-Lok fitting sleeve is designed for a slip fit, this should happen easily. Short tubes can be brazed in the vertical position. On longer tubes, the joint may need to be in the horizontal position, requiring a slight nudge to seat the sleeve on the tube.
- 4. Applying flux:** Apply proper flux to tube end (about 1½ sleeve lengths) and sleeve's face and outside surface. Insert appropriate braze ring in the sleeve and place the sleeve on end of the tube. The flux helps protect the parts from oxidizing and promotes braze flow.
- 5. Heating the part:** Apply heat uniformly to the joint by using a multi-flame torch as shown in Fig. S22 or with an induction braze unit. Proper brazing involves heating the assembly to brazing temperature and flowing the filler metal through the joint. Heat should be applied broadly and uniformly to the tube as well as the Seal-Lok sleeve. Keep in mind that thicker fitting and tubing sections take longer to heat. The entire assembly should heat to brazing temperature at about the same time. The braze alloy will always flow towards the area of higher temperature. The pre-formed braze ring has been placed inside the joint area—the last area to reach melting temperature. Therefore, when you see the braze material flow to the outside of the joint, you know the joint is complete. If the sleeve does not settle, a slight pressure will cause the sleeve to settle, completing the braze joint.
- 6. Cleaning the brazed joint:** After stopping heat application, allow about 10 seconds for the braze alloy to solidify. Then, immerse the joint in hot water (approx. 140°F.). To make cleaning easier, add braze cleaner to the hot water. This sudden cooling cracks the braze flux residue, making it easier to remove. Any remaining residue can be removed by careful wire brushing, making sure not to scratch the sealing surface of the sleeve.
- 7. Corrosion protection after brazing:** This is an extremely important step following brazing and even more so following the use of a braze cleaner. Braze cleaners available from Parker are used to facilitate the removal of residual flux after brazing, however are generally corrosive. The residue left on the surface by the cleaner, especially on the I.D. of the tube, can cause rusting in carbon steel tubes rather quickly, if it is not neutralized. Therefore, it is important to neutralize the cleaner residue after cleaning with a solution such as Bernite 136² (mix 4 ounces of Bernite 136 with one gallon of water). If the brazed parts are not to be used soon after brazing, a coating of rust inhibitors such as WD-40³ or SP-350⁴ is recommended for the braze and heat affected area.

2) Products of Bernite Products, Inc. 84 New York, Westbury, NY 11500 (516) 338-4646.
3) A product of WD-40 Company, San Diego, CA 92220.
4) A product of CRC Chemicals, USA, Warminster, PA 18974 (215) 674-4300

Inspection of Brazing

Inspect the braze for a fillet all the way around the tube at the far end (small diameter) of the sleeve.

Caution: If there are gaps in the fillet, the joint may not be sound. In this case, rebrazing is recommended. Remove the sleeve and rebraze a new one in its place.

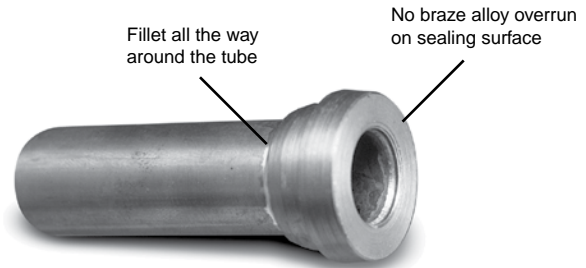


Fig. S24 – Brazed fitting

Inspect the sealing surface. There should be no braze alloy overrun or build-up on this surface. If there is build-up, remove it with emery paper, being careful not to scratch the seal surface. If this is not possible, remove the old sleeve and rebraze a new one in its place.

Final Installation

The following steps are required for final installation of the Seal-Lok fitting:

1. Ensure that the seal is properly installed in the groove of the face seal. Parker provides Seal-Lok fittings with pre-installed trap seals on the groove of the face seal. However, if the seal is being replaced, standard round O-Ring face seal O-rings can be found on page N4, in section N. Since Seal-Lok is machined with the Captive O-ring Groove (CORG), it is recommended that a CORG assembly tool be utilized, as shown in Fig. S25. To properly use the assembly tool, follow these steps
 - Position the O-ring inside the CORG assembly tool against the pusher.
 - Position the tool over the Seal-Lok tube end until the end is bottomed in the tool.
 - Push the plunger of the tool until the O-ring is inserted and seated into the groove.

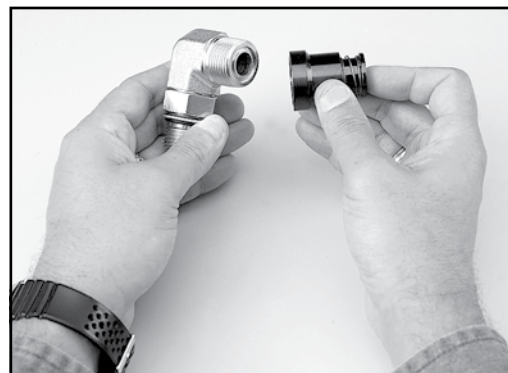


Fig. S25 – O-Ring installation using the CORG assembly tool

2. Place the tube assembly against the fitting body so that the flat face of the flange tube (or braze sleeve) comes in full contact with the O-ring. Thread the nut onto the fitting body by hand and tighten it to the recommended torque represented in Table S14. If torque wrenches are not available, an alternate method of assembly is the Flats From Wrench Resistance (F.F.W.R.) method. Wrench tighten the nut onto the fitting body until light wrench resistance is reached. Tighten further to the appropriate F.F.W.R. value.

Caution: The torque method of assembly is the preferred method of assembly for Seal-Lok fittings. It reduces the risk of human error during assembly that is more prevalent in the Flats From Wrench Resistance (F.F.W.R.) method. To ensure the most accurate assembly of the Seal-Lok fitting, it is strongly recommended that the torque method be utilized.

TABLE OF CONTENTS

SECTION TABLE OF CONTENTS

Note: A second wrench may be required to prevent the fitting from moving during assembly.

O.D.		SAE Dash Size	Tube Side Thread Size (UN/UNF)	Tube Side Assembly Torque (+10% -0%)			Flats from Wrench Resistance (F.F.W.R.)	
(in.)	(mm)			in.-lb.	ft.-lb.	N-m	Tube Nuts	Swivel & Hose Ends
1/4	6	-4	9/16-18	220	18	25	1/4 to 1/2	1/2 to 3/4
3/8	8, 10	-6	11/16-16	360	30	40	1/4 to 1/2	1/2 to 3/4
1/2	12	-8	13/16-16	480	40	55	1/4 to 1/2	1/2 to 3/4
5/8	14, 15, 16	-10	1-14	—	60	80	1/4 to 1/2	1/2 to 3/4
3/4	18, 20	-12	1 3/16-12	—	85	115	1/4 to 1/2	1/3 to 1/2
1	22, 25	-16	1 7/16-12	—	110	150	1/4 to 1/2	1/3 to 1/2
1 1/4	28, 30, 32	-20	1 11/16-12	—	150	205	1/4 to 1/2	1/3 to 1/2
1 1/2	35, 38	-24	2-12	—	230	315	1/4 to 1/2	1/3 to 1/2
2	50	-32	2 1/2-12	—	375	510	1/4 to 1/2	1/3 to 1/2

Table S14 – Seal-Lok and UPTC assembly torque and F.F.W.R. For brass, aluminum (and other soft metals) decrease torque value by 35%, however F.F.W.R. is the same.

Dimensions and pressures for reference only, subject to change.

Seal-Lok Troubleshooting Guide

O-Ring Face Seal

TABLE
OF
CONTENTS

SECTION
TABLE OF
CONTENTS

CONDITION	PROBABLE CAUSE(S)	RECOMMENDATION
Immediate leakage when system is pressurized	<ul style="list-style-type: none"> Improper tightening of joint 	<ul style="list-style-type: none"> Check for O-ring damage and re-tighten connection to the recommended torque value
Under-flanged assembly	<ul style="list-style-type: none"> Undersized tube diameter resulting in tube slippage during flanging Die gripping surface is worn or dirty 	<ul style="list-style-type: none"> Verify that the O.D. is correct; if undersized, replace tube. Inspect die gripping surface; if clogged or excessively worn, clean or replace.
Over-flanged assembly	<ul style="list-style-type: none"> Sleeve is positioned incorrectly in die 	<ul style="list-style-type: none"> Check for proper positioning of sleeve in die; if over-flanged, replace tubing
Flange out-of-round	<ul style="list-style-type: none"> Tubing was not cut properly Tube was not properly supported during flanging Tubing is eccentric 	<ul style="list-style-type: none"> Cut tubing within $90^{\circ} \pm 1^{\circ}$ Support tubing so that tube end is perpendicular to tube stop during flanging Replace with quality tubing Replace out-of-round flanges
Cracked flange	<ul style="list-style-type: none"> Tubing too hard 	<ul style="list-style-type: none"> Replace tubing using recommended quality tube
Scored, pitted flange	<ul style="list-style-type: none"> Improper deburring and cleaning of tube prior to flanging Flange pin not cleaned and lubricated properly 	<ul style="list-style-type: none"> Replace flange using proper deburring and cleaning recommendations Keep flanging pin clean and working surfaces well lubricated.
Leakage at braze joint	<ul style="list-style-type: none"> Poor braze joint/improper joint clearance Mixing of sleeve and tube material Improper/inadequate flux, braze alloy overrun, or buildup on face Improper/inadequate braze temperature 	<ul style="list-style-type: none"> Flux and reheat the joint, remove and replace with new sleeve Always use steel sleeves with steel tubing and stainless sleeves with stainless tubing Apply flux liberally to sleeve and tube end prior to brazing. Use recommended flux, braze alloy and brazing temperature.
Leakage at face-seal end	<ul style="list-style-type: none"> Misalignment or improper fit Damaged, pinched, improper, or missing O-ring Extruded O-ring Damaged fitting Braze overflow on sealing surface 	<ul style="list-style-type: none"> Align tube end and connecting fitting properly before tightening tube nut, holding the flat face of the mating fitting against O-ring while tightening Replace O-ring, properly installing it in the face seal groove Replace O-ring and check for proper alignment and pressure surges exceeding rated pressure of fitting; tighten the nut to recommended torque or replace fitting if threads or sealing surface is grossly damaged. Remove and replace sleeve which has braze overflow on its sealing surface.

S

Table S15 – Seal-Lok Troubleshooting guide

Dimensions and pressures for reference only, subject to change.

Triple-Lok 37° Flare Fittings

For leak-free performance, the Triple-Lok fitting requires the following steps:

1. Cutting, deburring and cleaning of the tube
2. Flaring
3. Flare inspection
4. Installation

Caution: Use only seamless or welded and drawn tube that is fully annealed for flaring and bending. (See page T14 for tube/fitting material compatibility information.)

Step 1 has been covered in a previous section (see page S12).

For the recommended minimum and maximum tube wall thickness for Triple-Lok fittings, please refer to Table U3 on page U3.

Flaring

Several flaring methods, ranging from simple hand flaring to hydraulic/electric power flaring, are available. Various tools for flaring are shown on pages R27 through R34. Power flaring is quicker and produces more accurate and consistent flares compared to hand flaring. Therefore, it is a preferred method of flaring. Hand flaring should be limited to places where power flaring tools are not readily available. The Parflange machines shown on page R23 also flare tube with an orbital flaring process and provide the best flare for stainless steel tube.

Prior to flaring, determine the tube length allowance using Table S16. This tube length allowance should be added to the cut tube length to allow for the "loss" of tube caused by flaring.

Nominal Tube O.D.		A
Inch	Metric	
1/8	—	0.07
3/16	—	0.08
1/4	6	0.09
5/16	8	0.08
3/8	10	0.08
1/2	12	0.12
5/8	14, 15, 16	0.13
3/4	18, 20	0.15
7/8	22	0.15
1	25	0.15
1 1/4	30, 32	0.20
1 1/2	38	0.18
2	42	0.28

Table S16 — Tube length allowance

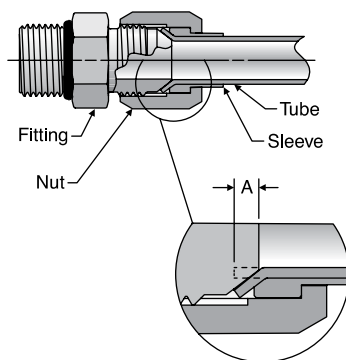


Fig. S26 — Tube length allowance



Fig. S27 — Flaring with Hydra-Tool



Fig. S28 — Nuts and sleeves assembled before flaring

Flare Inspection

Inspect flare for dimensions and surface quality. Table S17 shows the proper flare dimensions. The sleeve can also be used for a quick check of the flare dimensions as shown in Fig. S29.

Stainless steel lubricant is not necessary for assembly unless parts are washed or heated above 150°. The light wax coating will evaporate at that point.

Inch Tube O.D. (in.)	Metric Tube O.D. (mm)	37° Flare Diameter ØA (in.)
1/4	6	.340/.360
5/16	8	.400/.430
3/8	10	.460/.490
1/2	12	.630/.660
5/8	15 & 16	.760/.790
3/4	18 & 20	.920/.950
1	25	1.170/1.200
1 1/4	30 & 32	1.480/1.510
1 1/2	38	1.700/1.730

Table S17 — 37° Flare Dimensions

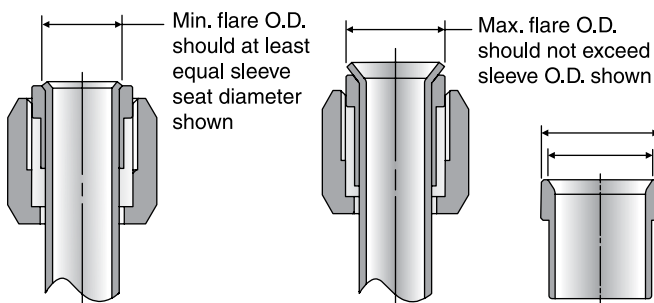
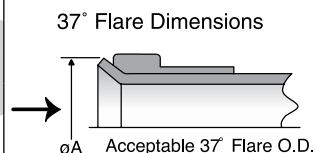


Fig. S29 — Comparing flare O.D. with sleeve seat and O.D.

Flare tube end using one of the flaring tools and following its operating instructions. Fig. S26 shows flaring with Hydra-Tool.

Note: Be sure to insert a nut and a sleeve in proper sequence and orientation before flaring either end of a bent tube, or second end of a straight tube (see Fig. S27).

Underflaring (see Fig. S30) reduces contact area causing excessive nose collapse and leakage; or, in extreme cases, tube pull out under pressure.

Overflaring (see Fig. S30) causes tube nut thread interference, either preventing assembly altogether, or giving a false sense of joint tightness resulting in leakage.

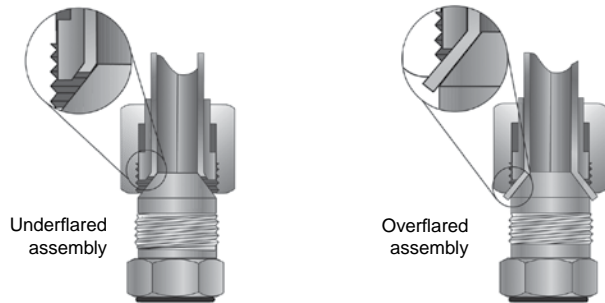


Fig. S30 – Underflaring and overflaring

The flare must be reasonably square and concentric with the tube O.D.; and its surface must be smooth, free of rust, scratches, splits, weld beads, draw marks, embedded chips, burrs or dirt. If the flare does not meet the above requirements, cut it off, determine the probable cause from the troubleshooting guide shown in Table S20, take corrective action and re-flare.

Installation

Improper flaring or installation causes over half of the leakage with flared fittings. Thus, proper installation is critical for a trouble free operation.

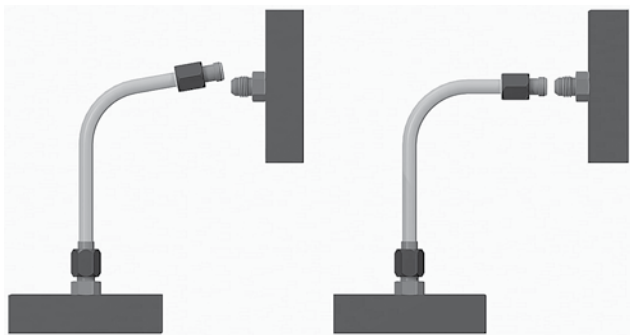


Fig. S31 – Improper bend and short tube

Align the tube on the flare (nose) of the fitting body and tighten the nut using one of two methods described below.

1. Flats from Wrench Resistance (FFWR) or “Flats” method
2. Torque method

Note: Do not force an improperly bent tube into alignment (Fig. S31) or draw-in too short a tube using the nut. It puts undesirable strain on the joint leading, eventually, to leakage.

Flats Method

Tighten the nut lightly with a wrench (approximately 30 in.lb.), clamping the tube flare between the fitting nose and the sleeve. This is considered the Wrench Resistance (WR) position. Starting from this position, tighten the nut further by the number of flats from Table S18. A flat is referred to as one side of the hexagonal tube nut and equates to 1/6 of a turn.

This Flats method is more forgiving of the two. It circumvents the effects of differences in plating, lubrication, surface finishes, etc., that greatly influence the torque required to achieve proper

joint tightness or clamping load. Therefore, it is recommended to use this method wherever possible, and especially where the plating combination of components is not known, and during maintenance and repair where the components may be oily. Use Table S18 as a guide for proper tightening method.

Condition	Recommended Tightening Method
1. Plating of all components is the same.	Either method is acceptable. Use Table S19.
2. Plating is mixed.	Use FFWR method.
3. Plating of nut and sleeve or hose end is unknown.	Use FFWR method.
4. Parts are oily.	Use FFWR method.
5. Stainless or brass components.	Use FFWR method.

Table S18 – Joint tightening method guide

Parker also recommends that wherever possible, the step of marking the nut position relative to the body should be done. This step serves as a quick quality assurance check for joint tightening. To do this, at the initial wrench resistance position, make a longitudinal mark on one of the flats of the nut and continue it on to the body hex with a permanent type ink marker as shown in Fig. S32. Then, at the properly tightened position, mark the body hex opposite the previous mark on the nut hex.

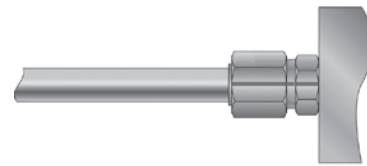


Fig. S32 – Make reference mark on nut and tube body

These marks serve two important functions:

1. The displaced marks serve as a quick quality assurance check that the joint has been tightened.
2. The second mark on the body serves as a proper tightening position after a joint has been loosened.

The flats method is slower than the torque method, but it has the two distinct advantages described earlier, namely, circumvention of plating differences and a quick visual check for proper joint tightening.

Torque Method

With proper tube flare alignment with the nose of the fitting, tighten the nut to appropriate torque value in Table S19. This method is fast and accurate when preset torque wrenches are used. Consistent component selection is recommended so that the effects of dissimilar plating is not an adverse factor in joint integrity. This makes it desirable for high production assembly lines. However, a joint assembled using the torque method can only be checked for proper tightening by torquing it again.

Note: This method should not be used if the type of plating on the fitting and mating parts (sleeve + nut or hose swivel) is not known. The torque method should not be used for lubricated or oily parts as improper clamping forces may result. Over-tightening and fitting damage may occur as a result.

TABLE OF CONTENTS

SECTION TABLE OF CONTENTS



Tube O.D. (in.)	Thread Size	Assembly Torque* (+10% -0)		Tube Connection FFWR	Swivel Nut or Hose Connection FFWR
		in. lb.	ft. lb.		
1/8	5/16-24	35	3	—	—
3/16	3/8-24	65	5	—	—
1/4	7/16-20	155	13	2 1/2	2
5/16	1/2-20	165	14	2	2
3/8	9/16-18	265	22	2	1 1/2
1/2	3/4-16	505	42	2	1 1/2
5/8	7/8-14	720	60	1 1/2	1 1/2
3/4	1 1/16-12	1000	84	1 1/2	1 1/4
7/8	1 3/16-12	1200	100	1 1/2	1 1/4
1	1 5/16-12	1415	118	1 1/2	1
1 1/4	1 5/8-12	2015	168	1	1
1 1/2	1 7/8-12	2340	195	1	1
2	2 1/2-12	3180	265	1	1
2 1/2	3-12	—	—	1	1

Notes:

1. Assembly Torque: Torque values are for unlubricated carbon steel components and properly lubricated stainless steel components. All stainless steel Triple-Lok tube nuts have an anti-seize lubricant to prevent galling during assembly.
2. FFWR: The Flats From Wrench Resistance or “Flats” method is recommended for steel, stainless steel and brass components.
3. Torque and FFWR: Torques and FFWR shown in the chart are for use with the tube materials, wall thickness, etc. recommended by Parker Hannifin Tube Fittings Division for use with Parker Triple-Lok fittings.

Table S19 – Triple-Lok assembly torques and FFWR
For brass and aluminum fittings, use approximately 65% of the torque values shown, unlubricated, however FFWR is same for all materials.

Triple-Lok Troubleshooting Guide

37° Flare

CONDITION	PROBABLE CAUSE(S)	RECOMMENDATION
Tube nut binds to tube flare Tube nut cannot engage the fitting body	• Flare too large or tube wall too heavy	• Flare new tube end using proper flare diameters
Flare is out-of-round (lopsided)	• Tube cut at an angle	• Re-cut tube, reasonably square, to 90° ± 1° and flare new tube end
Nicks, scratches, pock marks on tube flare of fitting	• Contaminants on tube ID or flaring cone/pin prior to flaring • Worn/damaged flaring cone/pin • Poor-quality tube	• Flare new tube end using proper tube preparation techniques • Assure that flare cone is clean • Replace poor-quality tube
Tube crack on flare	• Poor-quality welded tube; work-hardened tube; tube not annealed (too hard)	• Flare new tube end using appropriate tube (e.g., fully annealed) and tube cutting methods
Tube nut bottoms out before seats are mated properly	• Unintentional use of 45° flare tube nut, or tube sleeve was omitted	• Use appropriate 37° flare components (body, nut and sleeve)
Immediate leakage from tube nut	• Connection may not be tightened properly (if at all)	• Check joint for appropriate FFWR or torque; retighten as appropriate
Tube nut continues to back off or loosen	• Damaged Fitting • Excessive vibration • Improper assembly torque	• Replace damaged fitting • Re-route or clamp properly • Assemble to appropriate torque
Damaged fitting and/or nose collapse, flow reduction	• Frequent assembly and disassembly or over-tightening	• Fitting should be replaced and tightened properly; avoid frequent assembly/disassembly

Table S20 — Triple-Lok Troubleshooting guide

Dimensions and pressures for reference only, subject to change.



Ferulok Flareless Bite Type Fittings

Ferulok fitting assembly consists of the following steps:

- 1) Cutting, deburring and cleaning of the tube
- 2) Ferrule pre-set
- 3) Pre-set inspection
- 4) Final installation

Step 1 (cutting, deburring and cleaning of the tube) has been previously covered (see page S12).

For the recommended minimum and maximum tube wall thickness for Ferulok fittings, please refer to Table U3 on page U3.

Prior to pre-setting, determine the tube length allowance "A" using Table S21.

Nominal Tube O.D.	A
1/8	0.19
3/16	0.23
1/4	0.23
5/16	0.25
3/8	0.25
1/2	0.31
5/8	0.35
3/4	0.35
7/8	0.35
1	0.42
1 1/4	0.42
1 1/2	0.49
2	0.49

Table S21 — Tube length allowance

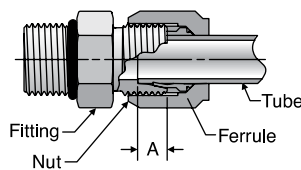


Fig. S33 — Tube length allowance

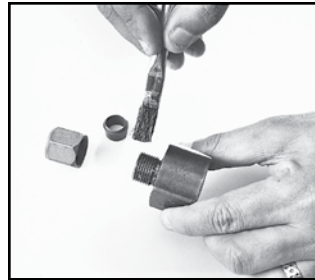
Ferrule Pre-set

Prior to final installation, the Ferulok fitting requires a pre-setting operation that creates a bite by the ferrule into the outer surface of the tubing. Pre-setting can be accomplished by two different methods: hydraulically using a Hyferset Tool or a Hydra-Tool, or manually using a hardened Ferulset tool or the fitting body.

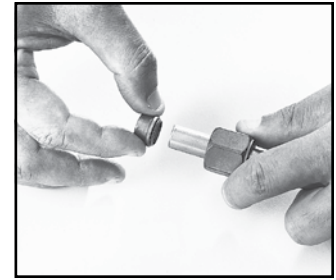
When using the Hyferset or Hydra-Tool method, the pressure build-up "bites" the ferrule into the tubing. When using the Ferulset or fitting body, thread the connection to finger tight and wrench an additional 1-3/4 turns. This will "bite" the ferrule into the tube.

Pre-setting using Ferulset Tool or Fitting Body

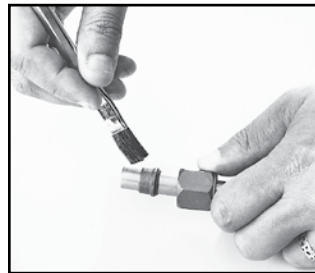
Ferulset pre-setting tools made from hardened steel are available for sizes 2 through 32. (See page R39.) They are recommended over the fitting body because they can be used repeatedly to perform the pre-set operation. The fitting body can be used only once for pre-setting and should be used during final installation with the pre-set tube line. The following steps are required for proper pre-set of the ferrule using the Ferulset tool or fitting body.



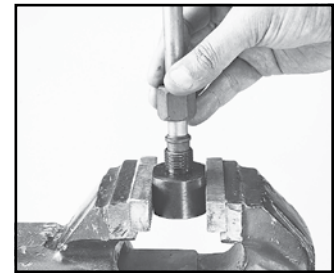
Step 1 – Lubricate thread and cone of Ferulset Tool (or fitting body).



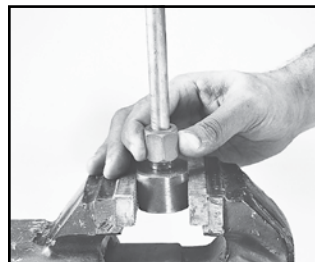
Step 2 – Slip nut and ferrule over deburred tube end. Be sure the long, straight end of the ferrule points toward tube end.



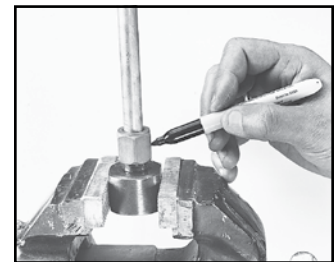
Step 3 – Lubricate ferrule with system fluid or a compatible lubricant.



Step 4 – Bottom tube end firmly on internal shoulder of Ferulset Tool (or fitting body).



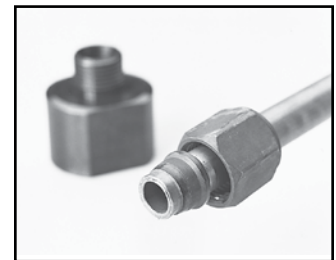
Step 5 – Manually screw nut onto Ferulset Tool or fitting body until finger tight.



Step 6 – Make reference mark on nut and tube.



Step 7 – Hold tube steady against internal shoulder of Ferulset Tool or fitting body and tighten nut an additional 1-3/4 turns.



Step 8 – Loosen nut and check for proper pre-set. Use the following inspection criteria.

TABLE OF CONTENTS

SECTION TABLE OF CONTENTS

S

Pre-setting with Hyferset Tool or Hydra-Tool

Pre-setting with hydraulic equipment (Hyferset or Hydra-Tool) is preferred for fittings larger than size 8 or large production quantities in any sizes.

For full instruction on the use of the Hyferset Tool (see Fig. S34), please refer to Bulletin 4393-B1, which is included with each shipment of the Hyferset Kit #611049C. For full instructions on the use of the Hydra-Tool, please refer to Bulletin 4392-B10.

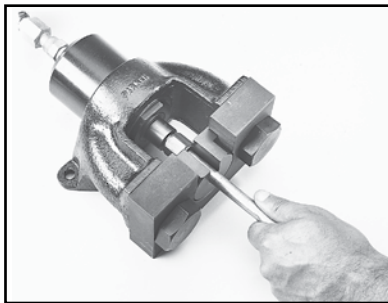


Fig. S34 – Hyferset tool

Pre-Set Inspection

All Ferulok fitting presets must be disassembled and inspected for proper ferrule pre-set before final installation. The following detailed inspection procedures must be followed regardless of the method used to pre-set the ferrule to the tube. (Refer to Fig. S35 for the five inspection points discussed below).

1. A ridge of metal (A) has been raised above the tube surface

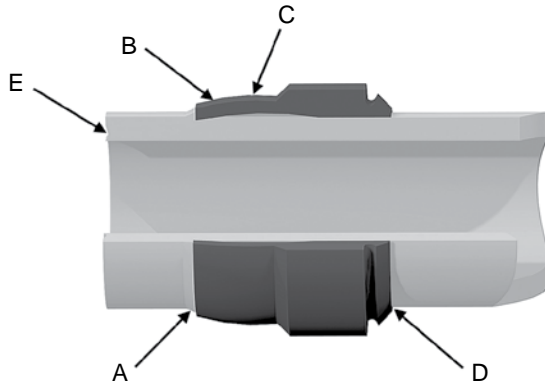


Fig. S35 – Ferulok preset inspection points

to a height of at least 50% of the thickness of the ferrule's leading edge, completely around the tube.

2. While the leading edge of the ferrule may be coined flat (B) there is a slight bow to the balance of the pilot section (C).
3. The tail or back end of the ferrule is snug against the tube (D).

4. There is a slight indentation around the end of the tube (E) that indicates the tube was bottomed in the tool or fitting during pre-setting.
5. Avoid rotating the ferrule. Steel ferrules should not be capable of moving back and forth along the tube beyond the bite area (a stainless steel ferrule will move more than steel because of its spring back characteristics).

Caution: Wrench torque should never be used as the gauge for reliable Ferulok pre-set and/or assembly. The reliability of the pre-set and assembly of bite type fittings is dependent on the ferrule traveling a prescribed distance into the tapered fitting throat in order to bite into the tube and effect a strong grip and seal.

Installation

Use one of the following installation procedures, depending on the tooling used earlier to pre-set the ferrule to the tubing.

1. **Fitting body, Hyferset, Hydra-Tool, or Ferulset used to pre-set ferrule** – If the fitting body was used for pre-setting the ferrule, complete the final installation with the **same** fitting body. If one of the tools was used, select the compatible fitting body and lubricate* the threads. Tighten the nut until a sudden and noticeable wrench resistance is achieved. Then wrench an additional **1/6 to 1/4 turn** to complete the final assembly.
2. **Swivel nut assembly procedure (R6BU, C6BU and S6BU)** – For final assembly of swivel nut, a **3/4 turn** from finger tight is required for all sizes.

*No additional lubrication is required with stainless steel fittings as the nuts are pre-lubricated.



Ferulok Troubleshooting Guide

Problems with bite type hydraulic fittings are most often traced to faulty Pre-Set/Assembly procedure.

Problem / Probable Cause	Remedy
Tube not bottomed	Check for the indentation on the tube end or compare the length from the end of the tube to the front end of the ferrule of a known good assembly to that of the assembly in question. This assembly should be scrapped. (Fig. S36)
Shallow bite	Inspect for turned up ridge of material. A failure to achieve this ridge can be traced either to the nut not being tightened enough or the tube not being bottomed against the stop which allowed the tube to travel forward with the ferrule. In some instances this assembly may be re-worked. (Fig. S37)
Over-set ferrule	Too much pressure or more than 1 3/4 turns from finger tight were used to pre-set ferrule, or the nut was severely over-tightened in final assembly. This assembly should be scrapped. (Fig. S38)
Ferrule cocked on tube	The ferrule may become cocked on the tube when the tube end is not properly lined up with the body. Generally, this condition is caused by faulty tube bending. All bent tube assemblies should drop into the fitting body prior to make up. This assembly should be scrapped. (Fig. S39)
No bite	If all of the prior checks have been made and the ferrule still shows no sign of biting the tube, it may be that the tube is too hard. This assembly should be scrapped. (Fig. S40)

Table S22 – Ferulok fitting troubleshooting guide

Caution: Pre-set tools such as the Ferulset and Hyferset are preferred for pre-setting ferrules prior to final assembly. However, when an actual fitting body is used to pre-set the ferrule, that body should be connected only to the specific ferrule it was used to pre-set.

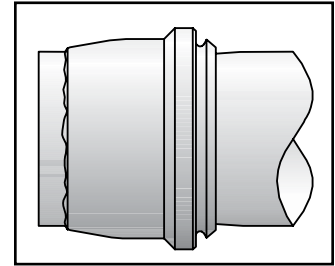


Fig. S36 – Tube not bottomed

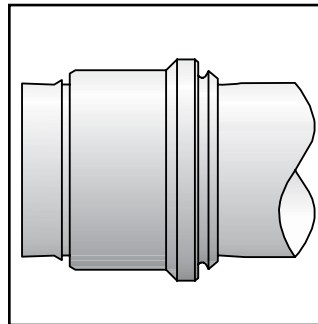


Fig. S37 – Shallow bite

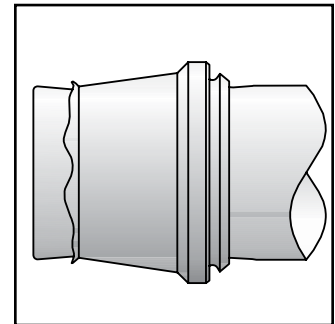


Fig. S38 – Over-set ferrule

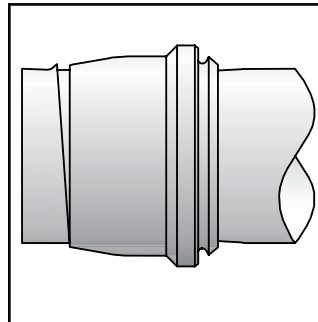


Fig. S39 – Ferrule cocked on tube

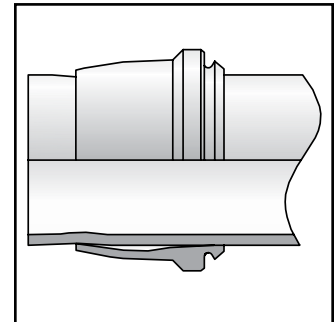


Fig. S40 – No bite

Dimensions and pressures for reference only, subject to change.

24° Flareless Bite

CONDITION	PROBABLE CAUSE(S)	RECOMMENDATION
Immediate leakage when system is pressurized	<ul style="list-style-type: none"> Improper ferrule/bite ring orientation 	<ul style="list-style-type: none"> Reset ferrule to ensure that the leading edge of ferrule/bite ring is pointing towards end of tube and seat of the mating fitting
Additional/excessive stress apparent on bite	<ul style="list-style-type: none"> Non-square tube cut; tube not being properly supported in seat of adapter 	<ul style="list-style-type: none"> Re-cut tube to $90^\circ \pm 1^\circ$
Flexural stresses allow tube to "rock" back and forth	<ul style="list-style-type: none"> Tube not fully supported in fitting's body seat 	<ul style="list-style-type: none"> Reset tube end. This time ensure that the tube is bottomed in the presetting tool or fitting body
Poor ferrule/bite ring pre-set and/or tube collapse	<ul style="list-style-type: none"> Tube may be too hard; or preset pressure or torque might be too high Tube is too thin 	<ul style="list-style-type: none"> Use fully annealed tube max hardness $R_B 72$ for steel, $R_B 90$ for stainless steel Consult manufacturer's minimum tube wall thickness requirements; tube supports must be used with certain thin-walled steel or stainless-steel tube. Review preset requirements
Tube not bottoming out in fitting body	<ul style="list-style-type: none"> Improper preset or wrong tool used for presetting 	<ul style="list-style-type: none"> In the presetting process, it is important to exert axial force on the tube to keep it fully bottomed in the tool. Check for indentation on end of the tube
Shallow bite of ferrule or cut ring into tube	<ul style="list-style-type: none"> Worn preset tool Too low preset pressure or torque Tube too hard Tube not bottomed against stop initially in preset 	<ul style="list-style-type: none"> Replace preset tool Observe manufacturer's recommendation for proper preset Ensure that tube is of correct hardness or material Hold tube against stop in preset
Tube pulls out of fitting in application and ferrule skives end of tube	<ul style="list-style-type: none"> Improper preset Tube too hard Excessive internal pressure Excessive axial load on tube Inadequate make up 	<ul style="list-style-type: none"> Preset must be inspected for evidence of proper preset, such as raised ridge of metal in front of leading edge Ensure that tube is of proper hardness and material Ensure that internal pressure is within rating of fitting (tube might be of a higher rating) Avoid additional axial load than that caused by internal pressure Follow proper presetting and assembly procedures
Fitting nut is tight but leakage still occurs	<ul style="list-style-type: none"> Overset ferrule Cracked tube Damaged components 	<ul style="list-style-type: none"> Excessive force used in presetting of ferrule can cause it not to spring back and effect a seal. Follow manufacturer's recommendation for preset Check tube for circumferential crack due to fatigue Check components for damage such as nicks, scratches and cracks

TABLE OF CONTENTS

SECTION TABLE OF CONTENTS

Intru-Lok Flareless Bite Type Fittings

The steps to properly assemble the Intru-Lok fitting are:

1. Cutting, deburring and cleaning of the tube
2. Installation

Cutting, Deburring and Cleaning

Cut soft metal tube with tube cutter, circular toothed cut-off saw, or hacksaw with a fine tooth saw blade. A square cut can be attained with a hacksaw using Parker's Tru-Kut Sawing Vise. With a Parker 226 In-Ex deburring tool (see page R22), lightly deburr the inside and outside corner of the tube end.

Plastic tube can be cut with a plastic tube cutter, Parker part number PTC-001 (available from the Parflex Division).

After cutting and deburring, remove loose burrs or dirt with a brush or compressed air.

Installation

Intru-Lok fittings are designed to permit tube entry and fitting make-up without removal of the nut and ferrule from the fitting body. The following steps are required for proper installation.

1. Insert the tube through the nut and ferrule until it bottoms on the seat within the fitting body.
2. Tighten the nut to the finger tight position, then wrench tighten 1 1/4 turns. (For low pressure instrument air service, 1 turn from finger tight is sufficient. This will also allow for the maximum number of remakes.)

Note: When using the BIP knurled nut and TIP insert for plastic tube, tighten the nut an additional 1 turn from the finger tight position.

Remake

The nut should be wrenched down until a sudden resistance to wrench force is evident. From this point wrench the nut 1/6 turn more to cause the ferrule to spring into its seal against the tube and fitting body.

Intru-Lok Troubleshooting Guide

Problems associated with bite type fittings are most often traced to faulty Pre-Set/Assembly procedure.

Problem / Probable Cause	Remedy
Tube not bottomed	On soft metal tubing, check for the indentation on the tube end. For plastic tubing or soft metal, compare the length from the end of the tube to the front end of the ferrule of a known good assembly to that of the assembly in question. This assembly should be scrapped.
Shallow bite	Inspect for turned up ridge of material at the front of the ferrule. A failure to achieve this ridge can be traced either to the nut not being tightened enough or the tube not being bottomed against the stop which allowed the tube to travel forward with the ferrule. In some instances this assembly may be re-worked.
Over-set ferrule	More than 1 1/4 turns from finger tight were used to pre-set ferrule, or the nut was severely over-tightened in final assembly. This assembly should be scrapped.
Ferrule cocked on the tube	The ferrule may become cocked on the tube when the tube end is not properly lined up with the body. Generally this condition is caused by faulty tube bending. All bent tube assemblies should fit into the fitting body prior to make up. This assembly should be scrapped.

Table S23 – Intru-Lok troubleshooting guide

TABLE OF CONTENTS

SECTION TABLE OF CONTENTS

S

EO Metric Bite Type Fittings

The proper make-up and assembly of EO bite type fittings, as with other fittings, is critical to their proper functioning. Proper assembly consists of the following steps:

1. Cutting, deburring and cleaning of the tube
2. Pre-set of progressive ring
3. Pre-set inspection
4. Installation

Step 1 (cutting, deburring and cleaning of the tube) has been previously covered on pages S12-S13.

Pre-set of Progressive Ring

The EO fitting requires a pre-set operation that creates a bite by the progressive ring into the outer surface of the tube. There are two methods of achieving the pre-set:

- Manually with the fitting body or hardened pre-assembly tool (not recommended for stainless steel tube).
- Hydraulically with the EO-Karrymat, Hydra Tool or Hyferset

Pre-set Using the Fitting Body or Hardened Pre-assembly Tool

Pre-setting with the fitting body is only recommended for steel and copper tubes. For frequent pre-setting, stainless steel tube and hose standpipe fittings, a hardened pre-assembly tool (VOMO) is strongly recommended (see Fig. S41).

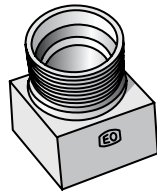
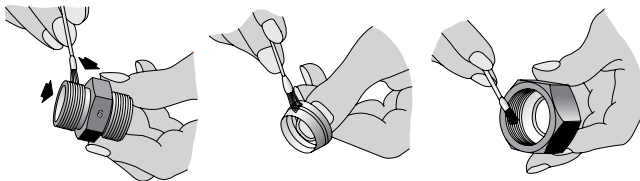


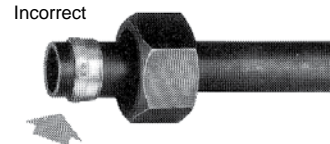
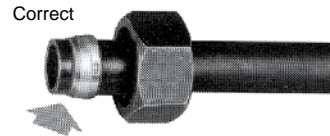
Fig. S41 – VOMO pre-assembly tool

Steps for pre-set using the fitting body or the hardened pre-assembly tool.

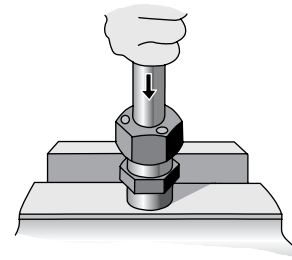
1. Lubricate thread and cone of fitting body or hardened pre-assembly tool, as well as the progressive ring and nut threads.



2. Slip nut and progressive ring over tube, assuring that they are in the proper orientation.



3. Screw nut onto fitting body or hardened pre-assembly tool until finger-tight or light wrench resistance. Hold tube against the shoulder in the cone of the fitting body or hardened pre-assembly tool.



4. Mark nut and tube in the finger-tight or light wrench-resistant position.

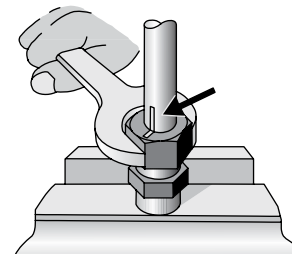


TABLE
OF
CONTENTS

SECTION
TABLE OF
CONTENTS

5. Tighten nut 1½ turns if using the fitting body (1-1/2 turns if using the hardened pre-assembly tool). The tube must not turn with the nut. The stop edge in the progressive ring limits over tightening by sharply increasing the tightening torque.

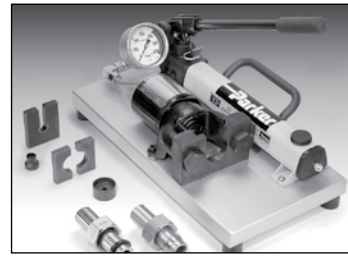
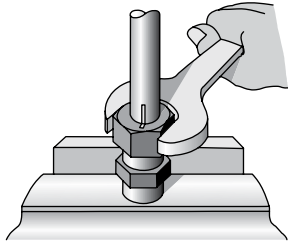
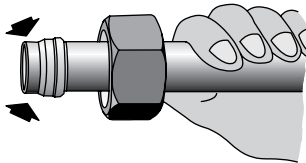


Fig. S43 – EO Karrymat

Pre-set Inspection

To inspect the pre-set, remove the nut and tube from the fitting and check if a visible collar fills the space completely in front of first cutting edge. If not, tighten slightly more. It does not matter if ring can be rotated on tube end.



For full instruction on the use of these hydraulic tools, please refer to the Bulletins indicated below:

- EO-Karrymat – Bulletin 4044-T1/UK/DE/FR/T
- Hyferset - Bulletin 4393-B1
- Hydra-Tool – Bulletin 4392-B10

Installation

To install the pre-set tube assembly to the fitting body, wrench-tighten nut to wrench resistance (light wrenching). From this position, tighten nut another 1/12 turn or 1/2 flat (30°) of the nut. Another wrench must be used to prevent movement of the fitting body.

Pre-set Using EO-Karrymat, Hydra-Tool or Hyferset

When pre-setting EO fittings larger than sizes 18 mm, it is recommended that a hydraulic tool be used. The EO-Karrymat, Hydra-Tool or the Hyferset (shown in Fig. S42) are recommended for low to medium volume production.

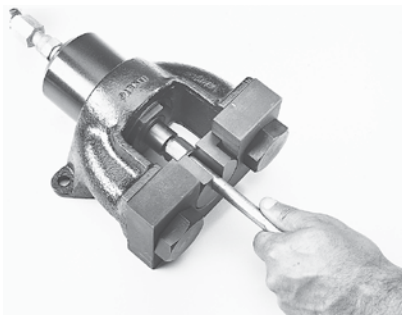
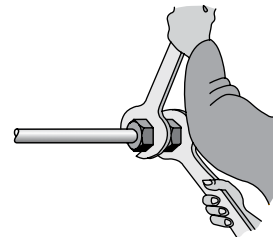


Fig. S42 – Hyferset tool



Assembly with Support Sleeve (VH)

If the tube wall thickness is small relative to the tube O.D., this may lead to tube collapse. As a rule, the tube collapse (reduction in diameter) should not exceed 0.3 mm for tubes up to 16 mm O.D. and 0.4 mm for tubes from 18 mm O.D. and above.

When assembling thin walled tube, there is insufficient cross sectional rigidity where the progressive ring cuts. This will have a detrimental effect on the sealing efficiency. For this, internal support sleeves (VH) are available which are inserted in the tube to prevent tube collapse and also increase the cross-sectional rigidity.

S

The shape of the tube supports allows them to be inserted easily in the tube. One end of the EO support sleeve is enlarged on its external diameter by a knurl. On insertion, this knurl forces itself into the interior wall of the tube and secures the sleeve against shifting or falling out during assembly and without widening the tube end.

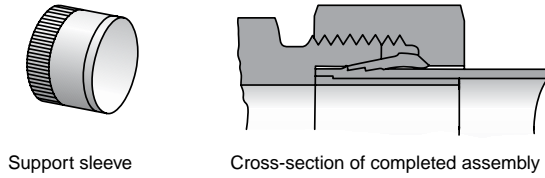


Fig. S44 — EO fitting completely assembled with support sleeve

Steel tubes made of 37.4 or soft metal tubes can be checked in accordance with Figs. S45 and S46, respectively, to see if they require support sleeves; for plastic tubes, (support) sleeves are always necessary (see Page E15 for E type sleeves).

For stainless steel tubes of material 1.4571/1.4541, refer to Fig. S44 to determine the need for a support tube.

For thin-walled steel tube of material St.37.4 and stainless steel tubes of material 1.4571/1.4541.

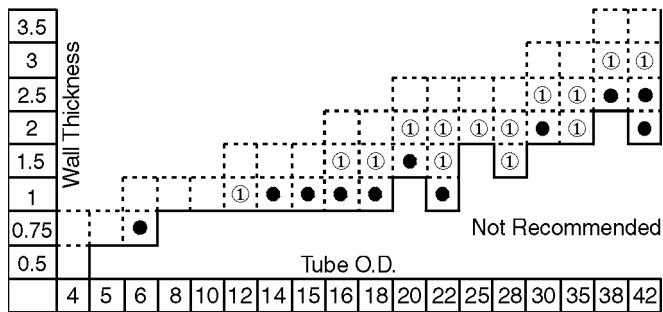


Fig. S45 — Recommended Tube Wall Thicknesses, Steel, SS

- Use of VH necessary
- ① Use of VH is recommended especially in case of frequent loosening and with heavy-duty tubes (vibrations)

For soft metal tubes

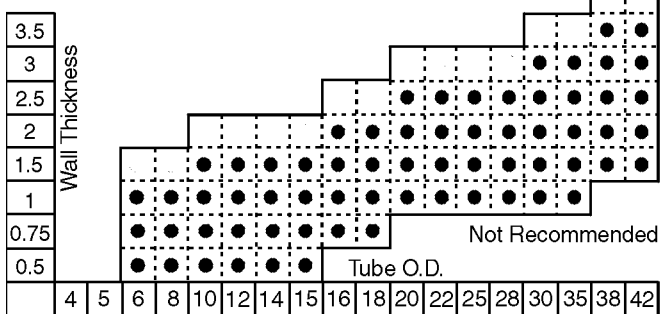
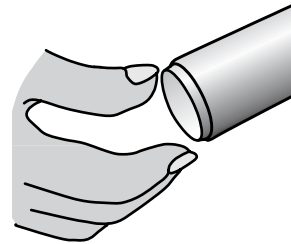


Fig. S46 — Recommended Tube Wall Thicknesses, Soft Metal Tubing

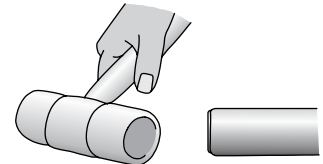
- Use of VH necessary
- ① Use of VH is recommended especially in case of frequent loosening and with heavy-duty tubes (vibrations)

Steps for Proper Assembly of Support Sleeve (VH)

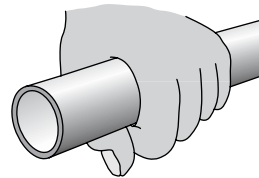
Step 1 – Insert support sleeve up to knurl.



Step 2 – Drive knurled end of support into tube.



Step 3 – Ensure that support sleeve is flush with tube end.



Step 4 – Pre-set progressive ring following one of the pre-setting methods covered earlier (page S29). The support sleeve prevents collapse of tube.

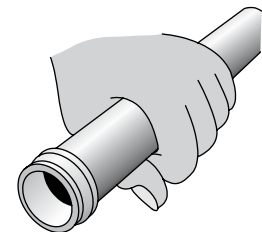


TABLE OF CONTENTS

SECTION TABLE OF CONTENTS

EO Troubleshooting Guide

Problems with bite type hydraulic fittings are most often traced to faulty pre-set/assembly procedure.

Problem	Solution
Tube not bottomed	Check for a visible mark on the tube end with EO fitting. (Fig. S47)
Shallow bite	Inspect for turned up ridge of material (collar). A failure to achieve this ridge can be traced either to the nut not being tightened enough or the tube not being bottomed against the stop which allowed the tube to travel forward with the ferrule. In some instances this assembly may be re-worked. (Fig. S48)
Over-set ferrule	Too much pressure or more than recommended turns from finger tight were used to pre-set ferrule, or the nut was severely over-tightened in final assembly. This assembly should be scrapped. (Fig. S49)
Ferrule cocked on tube	The ferrule may become cocked on the tube when the tube end is not properly lined up with the body. Generally, this condition is caused by faulty tube bending. All bent tube assemblies should drop into the fitting body prior to make up. This assembly should be scrapped. (Fig. S50)
No bite	If all of the prior checks have been made and the ferrule still shows no sign of biting the tube, it may be that the tube is too hard. This assembly should be scrapped. (Fig. S51)

Table S24 — EO Fitting troubleshooting guide

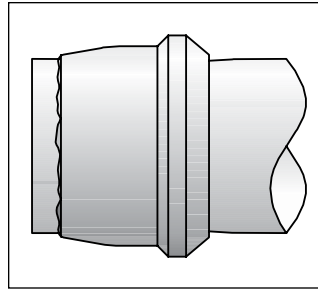


Fig. S47 — Tube not bottomed

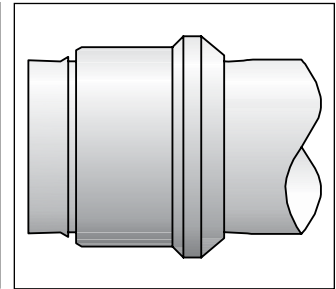


Fig. S48 — Shallow bite

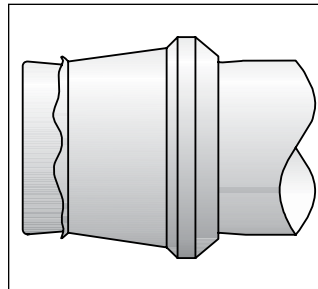


Fig. S49 — Over-set ferrule

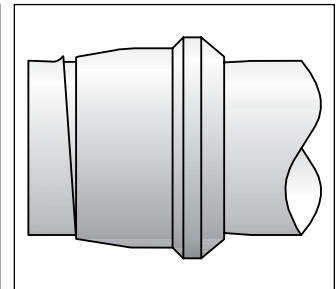


Fig. S50 — Ferrule cocked on tube

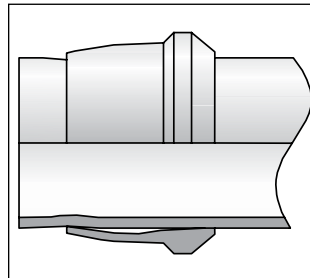


Fig. S51 — No bite

TABLE OF CONTENTS

SECTION TABLE OF CONTENTS

EO-2 Metric Bite Type Fittings

The steps for the proper assembly of the EO-2 fittings are similar to those of the EO fitting:

1. Cutting, deburring and cleaning of the tube
2. Pre-set of the retaining ring
3. Inspection of the pre-set
4. Installation

For step 1 (cutting, deburring and cleaning of the tube) please refer to page S12.

Pre-set of the Retaining Ring

The EO-2 functional nut consists of the nut, the sealing ring and the retaining ring. Unlike the EO fitting, the sealing and holding functions are performed by two separate components: the sealing ring and the retaining ring. The retaining ring must be pre-set to create the necessary bite on the tube O.D. The two methods to pre-set the retaining ring are:

- Manually with the fitting body or hardened pre-assembly tool (VOMO)
- Hydraulically with the EO-Karrymat, Hydra Tool or Hyferset

Pre-set Using the Fitting Body or Hardened Pre-Assembly Tool

1. Prepare the fitting or hardened pre-assembly tool by lubricating the threads of the following sizes:

Steel Fittings:

20, 22, 25, 28 Lubrication is recommended for ease in assembly

Stainless Steel Fitting:

For all sizes, lubrication is recommended for ease in assembly

High quality Niromont (liquid or paste) is recommended for lubrication of the fitting body threads.

It is strongly recommended that a hydraulic tool be used to preset EO-2 fittings in sizes 30S, 35L, 38S and 42L.

2. Insert tube into the EO-2 fitting body or hardened pre-assembled tool and press hard against the stop in the inner cone.

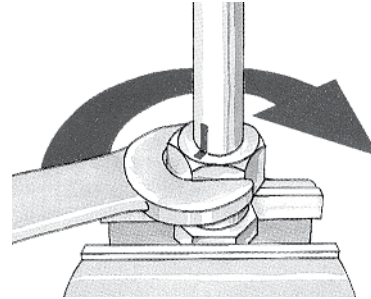
Note: A faulty assembly will result if the tube is not against the tube stop in the fitting body or hardened pre-assembly tool. To achieve the necessary assembling force, an additional wrench leverage may be necessary for tube O.D.'s 20mm and larger.

3. Turn nut until wrench resistance is felt. Tighten nut further



1 to 1-1/2 turns. As a recommended process control, mark the position of the nut relative to the fitting body.

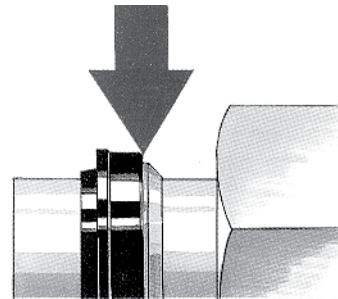
Pre-set Inspection



Loosen the nut and check that the gap between the sealing ring and retaining ring is fully closed. A slight gap (up to 0.2mm) due to spring back is acceptable.

*Refer to Fig. S45 and S46 for required support sleeves.

Pre-set Using EO-Karrymat, Hyferset,



Hydra-Tool and EOMAT III

EO-Karrymat: Recommended for use with EO-2 fittings from 6mm through to 42mm.

Hyferset: Recommended for use with EO-2 fittings from 6mm through to 28mm.

Hydra-Tool: Recommended for use with EO-2 fittings from 6mm through to 42mm.

For instructions on operating one of these machines, refer to the following bulletins:

- EO-Karrymat – Bulletin 4044-T1/UK/DE/FR/IT
- Hyferset – Bulletin 4393-B1
- Hydra-Tool – Bulletin 4392-B10

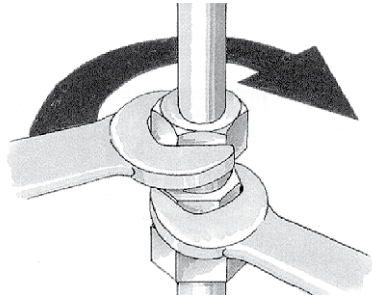
TABLE
OF
CONTENTS

SECTION
TABLE OF
CONTENTS

Installation

Connect tube and nut to fitting body. Holding the body rigid, tighten nut with a wrench until resistance is felt. Continue turning the nut approximately 1/6 to 1/4 turns (= 1 to 1-1/2 flats) to the same position as it was prior to disassembly.

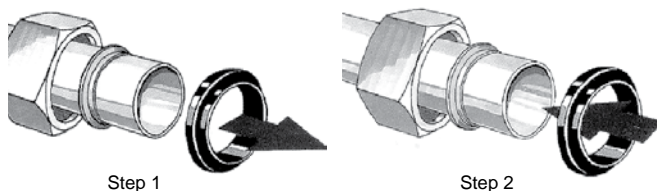
If the assembled position was marked, reassemble until the marks match. To achieve the necessary assembling force, use an additional wrench leverage for tube O.D.'s 20 mm and larger.



Caution: Improper tightening may reduce the seal reliability, pressure capability and the vibration resistance of the connection.

Re-Assembly with Replacement of Sealing Ring (DOZ)

1. After the nut has been loosened, the sealing ring can be pulled off the tube end. It must be checked for damage and replaced if necessary.
2. Push new sealing ring onto the tube, with metal inner cone facing the retaining ring.
3. Re-install using the installation procedures previously covered in this section.



EO-2 Troubleshooting Guide

Problems with bite type hydraulic fittings are most often traced to faulty pre-set/assembly procedure.

Problem/ Probable Cause	Remedy
Tube not bottomed	The tube end is not in firm contact with the fitting body at assembly. The tubing was not completely inserted into the throat of the fitting body until it bottomed out. Failure to bottom out the tubing against the tube stop of the fitting body during the presetting procedure will allow the tube to travel forward with the ferrule resulting in a shallow bite. This assembly should be scrapped.
Shallow bite	After presetting, inspect to see that the gap between the bite ring and the sealing ring is closed. A failure to achieve a closed gap can be traced to the nut not being tightened enough. This assembly can be reworked by completing the assembly instructions as indicated in the catalog. Utilization of lubrication and wrench elongation may be necessary for larger sizes.
Damaged Seals	Check sealing area for contamination such as chips, zinc particles or other dirt. Also check the inner cone of the fitting body and tubing for damage. Replace DOZ sealing ring if necessary.
Fatigue Crack at Bite	Ensure proper assembly techniques are utilized. Utilize lubrication and wrench elongation for larger sizes. Check that the gap between the sealing ring and bite ring are closed.
Fatigue Crack at Rear Shoulder of Bite Ring	Check that the application does not have excessive vibration. Utilize rigid clamping, tension piping or hose assemblies if relative movements are evident.
Distorted FM Functional Nut at Hydraulic Pre-Assembly	Utilize a split die nut back up plate for presetting of 35L and 42L functional nuts.

Table S25 — EO-2 troubleshooting guide

TABLE OF CONTENTS

SECTION TABLE OF CONTENTS

S

24° Flareless Bite

CONDITION	PROBABLE CAUSE(S)	RECOMMENDATION
Immediate leakage when system is pressurized	<ul style="list-style-type: none"> Improper ferrule/bite ring orientation 	<ul style="list-style-type: none"> Reset ferrule to ensure that the leading edge of ferrule/bite ring is pointing towards end of tube and seat of the mating fitting
Additional/excessive stress apparent on bite	<ul style="list-style-type: none"> Non-square tube cut; tube not being properly supported in seat of adapter 	<ul style="list-style-type: none"> Re-cut tube to $90^\circ \pm 1^\circ$
Flexural stresses allow tube to "rock" back and forth	<ul style="list-style-type: none"> Tube not fully supported in fitting's body seat 	<ul style="list-style-type: none"> Reset tube end. This time ensure that the tube is bottomed in the presetting tool or fitting body
Poor ferrule/bite ring pre-set and/or tube collapse	<ul style="list-style-type: none"> Tube may be too hard; or preset pressure or torque might be too high Tube is too thin 	<ul style="list-style-type: none"> Use fully annealed tube max hardness $R_B 72$ for steel, $R_B 90$ for stainless steel Consult manufacturer's minimum tube wall thickness requirements; tube supports must be used with certain thin-walled steel or stainless-steel tube. Review preset requirements
Tube not bottoming out in fitting body	<ul style="list-style-type: none"> Improper preset or wrong tool used for presetting 	<ul style="list-style-type: none"> In the presetting process, it is important to exert axial force on the tube to keep it fully bottomed in the tool. Check for indentation on end of the tube
Shallow bite of ferrule or cut ring into tube	<ul style="list-style-type: none"> Worn preset tool Too low preset pressure or torque Tube too hard Tube not bottomed against stop initially in preset 	<ul style="list-style-type: none"> Replace preset tool Observe manufacturer's recommendation for proper preset Ensure that tube is of correct hardness or material Hold tube against stop in preset
Tube pulls out of fitting in application and ferrule skives end of tube	<ul style="list-style-type: none"> Improper preset Tube too hard Excessive internal pressure Excessive axial load on tube Inadequate make up 	<ul style="list-style-type: none"> Preset must be inspected for evidence of proper preset, such as raised ridge of metal in front of leading edge Ensure that tube is of proper hardness and material Ensure that internal pressure is within rating of fitting (tube might be of a higher rating) Avoid additional axial load than that caused by internal pressure Follow proper presetting and assembly procedures
Fitting nut is tight but leakage still occurs	<ul style="list-style-type: none"> Overset ferrule Cracked tube Damaged components 	<ul style="list-style-type: none"> Excessive force used in presetting of ferrule can cause it not to spring back and effect a seal. Follow manufacturer's recommendation for preset Check tube for circumferential crack due to fatigue Check components for damage such as nicks, scratches and cracks

TABLE OF CONTENTS

SECTION TABLE OF CONTENTS

Bulkhead Locknut Assembly

A bulkhead fitting allows one to connect tube or hose through a panel. This panel, often referred to as bulkhead, may be a structural element of the equipment, or an additional plate which is joined to the equipment, to facilitate convenient routing of hose and tube. Bulkhead fittings are also used as a transition point in a hydraulic system, such as connection of tube lines to hose lines or to a quick disconnect coupling.

The following steps are recommended for the proper assembly of the locknut for Triple-Lok, Ferulok and Seal-Lok bulkhead fittings.

1. Drill a pilot hole to dimension $W + 0.015''$ (where W is shown in Tables S26 and S27).
2. Insert the bulkhead end of the fitting (without the locknut assembled) through the bulkhead opening and attach the locknut to the bulkhead end.
3. Finger tighten the locknut and wrench tighten further to the recommended torque shown in Table S28 for Seal-Lok fittings or Table S29 for Triple-Lok and Ferulok fittings.

TUBE FITTING PART #	THREAD SIZE UN/UNF	W*	ASSEMBLY TORQUE +10% - 0		
			in.-lb.	ft.-lb.	N-m
4 WLNL	9/16-18	0.56	180	15	20
6 WLNL	11/16-16	0.69	300	25	34
8 WLNL	13/16-16	0.81	—	55	75
10 WLNL	1-14	1.00	—	85	115
12 WLNL	1 3/16-12	1.19	—	135	180
14 WLNL	1 5/16-12	1.31	—	170	230
16 WLNL	1 7/16-12	1.44	—	200	270
20 WLNL	1 11/16-12	1.69	—	245	330
24 WLNL	2-12	2.00	—	270	365

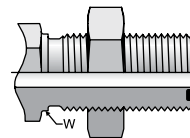
* Recommended clearance hole is $W + 0.015''$

Table S26 – Torque for Seal-Lok Bulkhead Fittings

TUBE FITTING PART #	THREAD SIZE UN/UNF	W*	ASSEMBLY TORQUE (+10 - 0)		
			in.-lb.	ft.-lb.	N-m
3 WLN	3/8-24	0.38	100	—	11
4 WLN	7/16-20	0.44	155	13	18
5 WLN	1/2-18	0.50	250	20	28
6 WLN	9/16-18	0.56	300	25	35
8 WLN	3/4-16	0.75	600	50	65
10 WLN	7/8-14	0.88	—	85	115
12 WLN	1 1/16-12	1.06	—	135	180
14 WLN	1 3/16-12	1.19	—	170	230
16 WLN	1 5/16-12	1.31	—	200	270
20 WLN	1 5/8-12	1.63	—	245	330
24 WLN	1 7/8-12	1.88	—	270	365
32 WLN	2 1/2-12	2.50	—	310	420

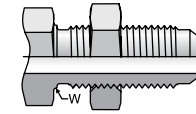
* Recommended clearance hole is $W + 0.015''$

Table S27 – Torque for Triple-Lok and Ferulok Bulkhead Fittings



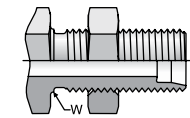
Seal-Lok Bulkhead Assembly

See page A8 for maximum bulkhead thickness.



Triple-Lok Straight Bulkhead

See page B8 for maximum bulkhead thickness.



Ferulok Straight Bulkhead

See page C6 for maximum bulkhead thickness.

TABLE OF CONTENTS

SECTION TABLE OF CONTENTS

Pipe Swivel Assembly (NPSM)

Unlike traditional pipe thread, these connections seal on the nose of the swivel end. The nose has a 60° inclusive angle that mates against a chamfer of the same angle on the male pipe thread end (also known as a 30° chamfer).

Fig. S52 - Illustration showing how swivel adapters seal on mating chamfer in male pipe thread end.

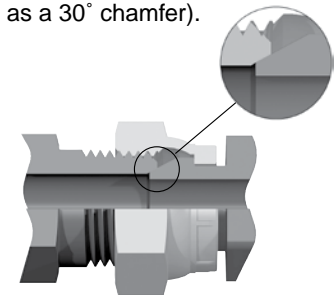


Fig. S52

NPSM Pipe Swivels

NPSM Pipe swivels, also known as Parker 07 Adapters, must connect with a male NPT/NPTF pipe thread with a 30° machined seat per SAE J514.

NPSM Size in.	Steel Assembly TORQUE (+10% - 0%)		
	in.-lb.	ft.-lb.	F.F.F.T.
1/8	106	9	1.0 - 1.5
1/4	156	13	1.0 - 1.5
3/8	192	16	1.0 - 1.5
1/2	396	33	1.0 - 1.5
3/4	580	48	2.0 - 2.5
1	1140	95	2.0 - 2.5
1 1/4	1420	118	2.0 - 2.5
1 1/2	2840	237	2.0 - 2.5
2	3720	310	2.0 - 2.5

Table S28 – NPSM Pipe Swivel Torques

Steps:

1. Finger tight
2. Wrench tighten to torque specs in Table (S28)

S

Dimensions and pressures for reference only, subject to change.

Routing and Clamping

Most hydraulic, pneumatic and lubrication systems require some form of tube line fabrication and fitting installation for completion. Proper fabrication and installation are essential for the overall efficiency, leak free performance, and general appearance of any system.

The following factors should be considered early in the design process, after sizing the tube lines and selecting the appropriate style of fitting:

1. Proper routing of tube lines
2. Adequate tube line support (clamping)

Routing of Lines

Routing of lines is one of the most difficult, yet most significant of these system considerations. Proper routing involves getting a connecting line from one point to another through the most logical path, while considering other factors as discussed below.

The most logical path is not always the direct path and should have the following characteristics:

- **Avoid excessive strain on joint** — A strained joint will eventually leak. A straight line tube assembly (with no bends) or a joint that is forced into position are common examples of strain applied to tube assemblies.
- **Allow for expansion and contraction** — Use a “U” bend or a hose in long lines to allow for expansion and contraction due to pressure or temperature fluctuations.
- **Allow for motion under load** — Even some apparently rigid systems do move under load. Use an offset (“S”) bend.
- **Get around obstructions without using excessive amount of 90° bends** — Pressure drop due to one 90° bend is greater than that due to two 45° bends.
- **Keep tube lines away from components that require regular maintenance.**
- **Leave fitting joints as accessible as possible** — Inaccessible joints are more difficult to assemble and tighten properly, and more time consuming to service.
- **Have a neat appearance and allow for easy trouble-shooting, maintenance and repair.**

The following illustrations provide several examples of typical routing situations. The graphics show the preferred and non-preferred path along with an explanation.





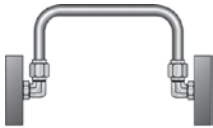


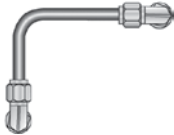

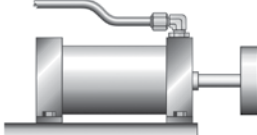



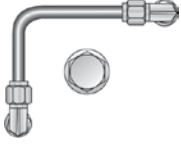
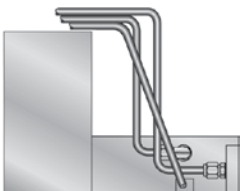
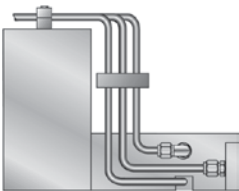
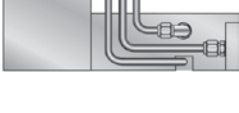
Non-preferred Routing	Preferred Routing	Explanation
   	   	<p>Avoid straight tube lines. There is no margin for error on a straight line, resulting in excess joint strain.</p> <p>Straight tube lines do not allow for expansion and contraction due to pressure and temperature fluctuations.</p>
		<p>Allow for expansion and contraction of lines by utilizing “U” bend.</p>
		<p>Offset (“S”) bend allows for motion under load.</p>
		<p>Avoid excessive pressure drop by getting around obstructions without using 90° bends. One 90° bend causes more pressure drop than two 45° bends.</p>
		<p>Avoid creating an obstruction by routing lines around areas that require service. Leave adequate clearance for wrenches.</p>
		<p>Route lines to allow for proper clamping. When done properly, several lines can typically be clamped together.</p>
		<p>Route lines to allow for trouble-shooting. Lines that cross and are not in logical order tend to be difficult to work with during maintenance.</p>

TABLE OF CONTENTS

SECTION TABLE OF CONTENTS

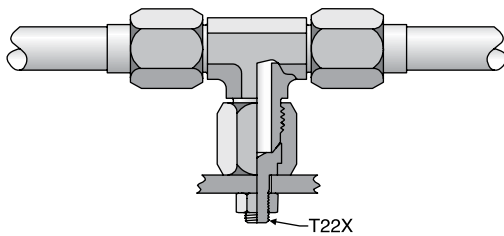
Tube Clamping

Tube line supports (clamps) serve two primary purposes in tube line systems; mounting and vibration dampening. Fatigue failure due to mechanical vibration accounts for the majority of tube line failures. Proper clamping of the tube also reduces system noise.

Use a clamping system such as Parker's ParKlamp along with proper clamp spacing provided in Table S31.

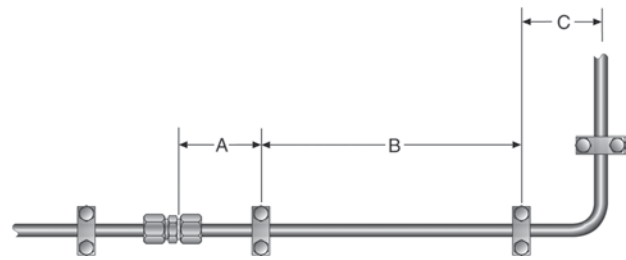
For tube clamps to dampen vibration effectively, they need to be anchored to a rigid structure. Clamping several tubes together, without rigid structural anchoring, does not provide effective dampening.

A mountie can be used in lieu of clamps in certain product lines by anchoring a tee fitting to the equipment's structure (see Fig. S53).



The Mountie Caps the End and Provides an Anchor

Fig. S53 — Mountie cap used with Triple-Lok for anchoring tube lines



Tube O.D.		A (in.)	B (ft.)	C (in.)
(in.)	(mm)			
1/4	6	2	3	4
5/16	8			
3/8	10			
1/2	12	4	5	8
5/8	14			
3/4	18			
7/8	22			
1	25	6	7	12
1-1/4	30			
1-1/2	38			
2	50			

Table S31 — Recommended tube clamp spacing

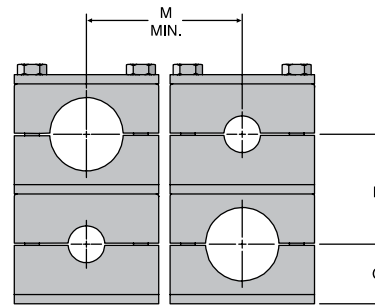
Layout Data for Tube, Pipe and Hose Clamps: Standard (Inch) and Series A (Metric)

Group #		Installation Dimensions				
		M	P	N	O	R
1	in.	1 5/16	1 3/16	1 3/16	5/8	15/16
	mm	33	30	30	16.5	24.5
1a	in.	1 7/16		1 1/8	5/8	15/16
	mm	36		29	16	24.0
2	in.	1 11/16		1 7/16	3/4	1 1/16
	mm	42		36	19.5	27.5
3	in.	2		1 1/2	13/16	1 1/8
	mm	50		38	20.5	28.5
4	in.	2 3/8		1 3/4	15/16	1 1/4
	mm	60		45	24	32.0
5	in.	2 13/16		2 3/8	1 1/4	1 9/16
	mm	70		61	32	40.0
6	in.	3 1/2		2 11/16	1 7/16	1 3/4
	mm	88		69	36	44.0

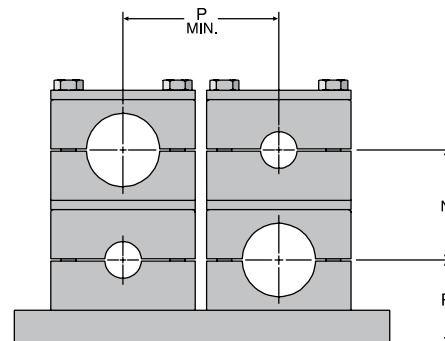
Table S29 — ParKlamp Standard Series Installation Dimensions

Bolt Thread	Torque	
	in.-lbs.	Nm
1/4 - 20 UNC	70	8

Table S30 — ParKlamp Standard Series maximum tightening torque



With Weld Plate



Rail Mounting

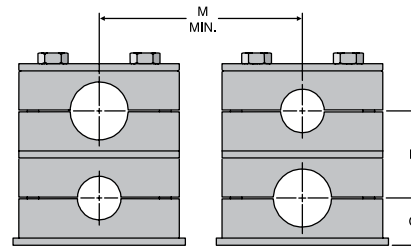
Dimensions and pressures for reference only, subject to change.

TABLE
OF
CONTENTS

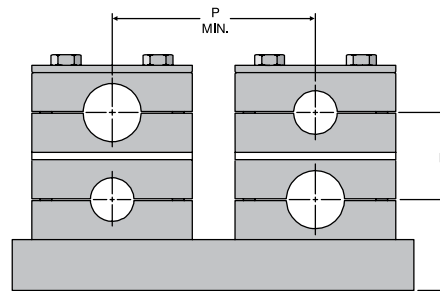
SECTION
TABLE OF
CONTENTS

Layout Data for Tube, Pipe and Hose Clamps: Heavy Series (Inch) and Series C (Metric)

Group #		Installation Dimensions				
		M	N	O	P	R
H3	in.	2 15/16	1 9/16	15/16	2 5/16	1 1/2
	mm	74	40	24	58	38
H4	in.	3 1/2	2 3/16	1 1/4	2 7/8	1 13/16
	mm	89	56	32	73	46
H5	in.	4 1/16	2 11/16	1 1/2	3 7/16	2 1/16
	mm	103	68	38	87	52
H6	in.	5 7/8	3 7/8	2 1/8	4 5/8	2 5/8
	mm	150	98	54	118	66
H7	in.	7 1/8	5 1/16	2 3/4	N/A	N/A
	mm	180	129	69	N/A	N/A



With Weld Plate



Rail Mounting

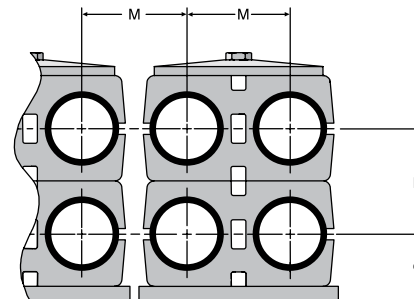
Table S32 — ParKlump Heavy Series installation dimensions

Group #	Bolt Thread	Torque	
		in-Lb	Nm
H3, H4	3/8 - 16 UNC	106	12
H5	3/8 - 16 UNC	133	15
H6	7/16 - 14 UNC	265	30
H7	5/8 - 11 UNC	398	45

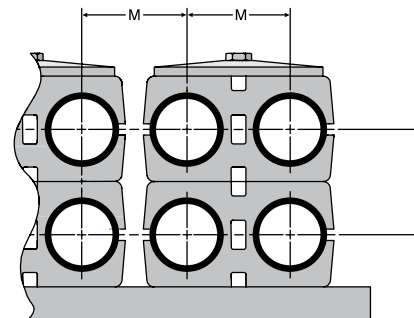
Table S33 — ParKlump Heavy Series maximum tightening torque

Layout Data for Tube, Pipe and Hose Clamps: Twin Series (Inch) and Series B (Metric)

Group #		Installation Dimensions			
		M	N	O	R
T1	in.	13/16	13/16	9/16	13/16
	mm	20	20	15	21
T2	in.	1 1/8	1	11/16	15/16
	mm	29	26	18	24
T3	in.	1 7/16	1 7/16	15/16	1 3/16
	mm	36	37	23.5	29.5
T4	in.	1 3/4	1 11/16	1	1 1/4
	mm	45	42	26	32
T5	in.	2 3/16	2 1/8	1 1/4	1 1/2
	mm	56	54	32	38



With Weld Plate



Rail Mounting

Table S34 — ParKlump Twin Series installation dimensions

Group #	Bolt Thread	Torque	
		in.-lbs.	Nm
T1	1/4 - 20 UNC	45	5
T2 - T4	5/16 - 18 UNC	104	12
T5	5/16 - 18 UNC	70	8

Table S35 — ParKlump Twin Series maximum tightening torque

Dimensions and pressures for reference only, subject to change.

Tools for Tube Bending

For smooth, wrinkle free tube bending without excessive flattening, there are a number of benders that can be selected. Consult the specific bender's instruction bulletins for CLR (centerline radius), wall thickness, and tube material recommendations and limitations. For crank and hydraulic benders, utilize both the mandrel bending determination chart (Fig. S57) and the Parker Bender Capacity Guides on page R7.

- 1. Hand held lever type benders** (see pages R4-R6). Individually sized for tube sizes 1/8" through 1" and 6mm through 25mm.

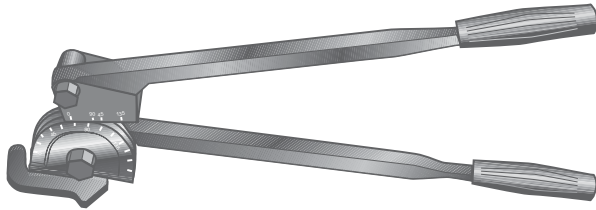


Fig. S54 — Hand held tube bender

- 2. Manual crank, table mount or vise mount benders:**

- 1) Model 412 (page R8). For bending 1/4" through 3/4" O.D. tube or 6mm through 20mm.
- 2) Model 424 (page R9). For bending 1/4" through 1 1/2" O.D. tube or 6mm through 38mm.

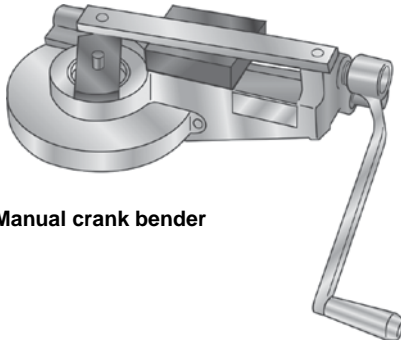


Fig. S55 — Manual crank bender

- 3. Hydraulically powered bender**

Model 632 (page R12). For bending 3/8" through 2" O.D. tube or 10mm through 50mm.

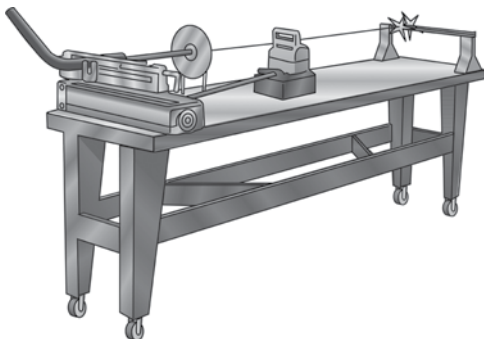


Fig. S56 — Hydraulic bender with portable table for mandrel bending

Mandrel Bending Tools

When bending thin wall tube it may be necessary to insert a mandrel into the tube to prevent excessive distortion, flattening or wrinkling. To determine whether mandrel bending is required, see the Mandrel Bending Requirements Chart and example below.

To accomplish such bending, a mandrel, mandrel rod, and a mandrel rod stop assembly are required. The rod stop assembly holds the end of the mandrel rod in proper alignment with the tube while the mandrel, which is threaded onto the other end of the mandrel rod, supports the tube on its I.D., thus preventing tube kinking or flattening during bending.

Mandrel Bending Requirements Chart

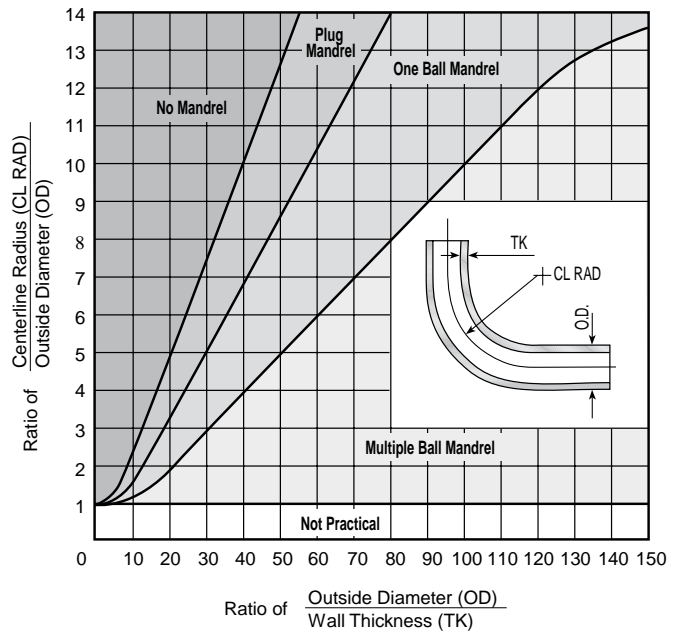


Fig. S57 — Mandrel bending requirements chart

Example: Determine if it's necessary to use mandrel for bending 3/4 x .049 steel tube through a 3" bend radius without excessive flattening.

$$\text{Centerline Radius/Tube Outside Diameter} = 3 / .75 = 4$$

$$\text{Outside Diameter / Wall Thickness} = .75 / .049 = 15.3$$

Intersection of these two ratios on the graph falls within the area indicating that no mandrel is required. Note, however, that for the same tube O.D. at a smaller bend radius (e.g. 2") or with a thinner wall thickness (e.g. .035"), a mandrel would be required for preventing excessive flattening.

If the tube wall is very thin, then a plug mandrel alone may not be adequate to prevent wrinkling. In such cases, special ball type mandrels and wiper shoes may be necessary (See Fig. S58 for illustrations of plug and ball type mandrels). As a rule of thumb, if the tube wall thickness is less than 7% of the tube O.D. then mandrel bending is recommended.

Dimensions and pressures for reference only, subject to change.

TABLE OF CONTENTS
SECTION TABLE OF CONTENTS

S

TABLE OF CONTENTS

SECTION TABLE OF CONTENTS

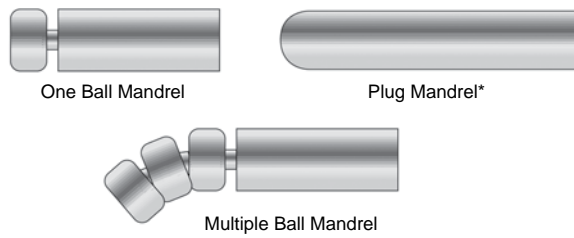


Fig. S58 — Types of mandrels

*Parker Tube Fittings Division offers only the plug mandrel.

Refer to Bulletin 4306-B5 for detailed bending instructions.

Plumbing and Assembly Hints

Even after choosing the appropriate type of fitting for your application, there are certain instances when a particular style has advantages over others.

1. Straight thread adjustable elbows and tees have several advantages over similar shaped fittings using tapered pipe threads:

Adjustable straight thread connections:

- Permit exact positioning
- Provide leak free joint
- Eliminate distortion and cracking of boss due to over-tightening
- Are easier to maintain

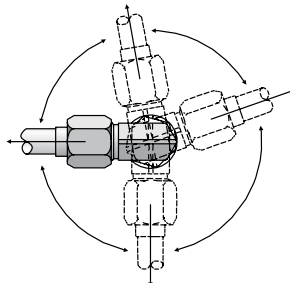


Fig. S59 — Top view of adjustable straight thread connection – allows for 360° positioning of fitting without losing its sealing capability

2. Swivel nut fitting should be used with a straight connector to allow for connections in tight spaces, where an elbow or tee fitting cannot be fully rotated (see Fig. S60).

This same combination of fittings, shown in Fig. S60, can also be used to stack tube lines or provide clearance for ports that are relatively close and within the same plane (see Fig. S61).

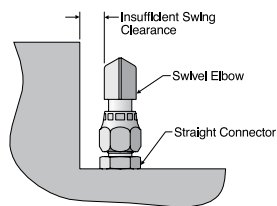


Fig. S60 — Swivel nut fitting used with straight connector in tight space

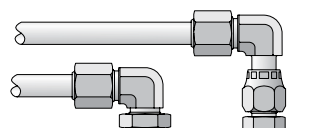


Fig. S61 — Swivel end fitting with straight connector provides clearance above regular elbow

3. Use reducers/expanders and jump size fittings.

There are some instances when it becomes necessary to connect tube lines of different sizes or tube lines to ports of different sizes. This can be accomplished by using either tube reducers, port expanders, port reducers, or jump size fittings. Achieving the reduction or enlargement is the main concern, but this should be accomplished by using the minimum number of connections (potential leak points and wrenching requirements) possible.

4. Use conversion fittings and adapters.

There are instances when it becomes necessary to use conversion adapters for connecting a fitting to a port with different style threads, for example, UNF thread fitting to a metric thread port. There are also some instances when it is necessary to connect tube ends or hose ends with different style terminations to one another or to a fitting. This can be achieved by using conversion fittings.

5. Use of other adapters and fittings for special applications are shown below.

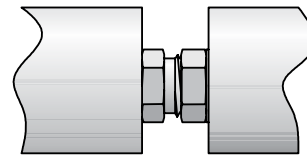


Fig. S62 — F50HAO for close coupling of components with two SAE Straight thread ports

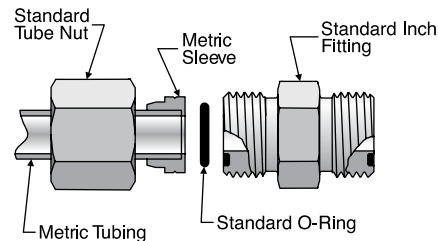


Fig. S63 — Metric sleeve adapts metric tube to standard Seal-Lok

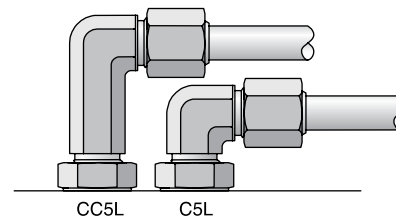


Fig. S64 — Long elbow (CC5L) stacks above regular elbow (C5L)

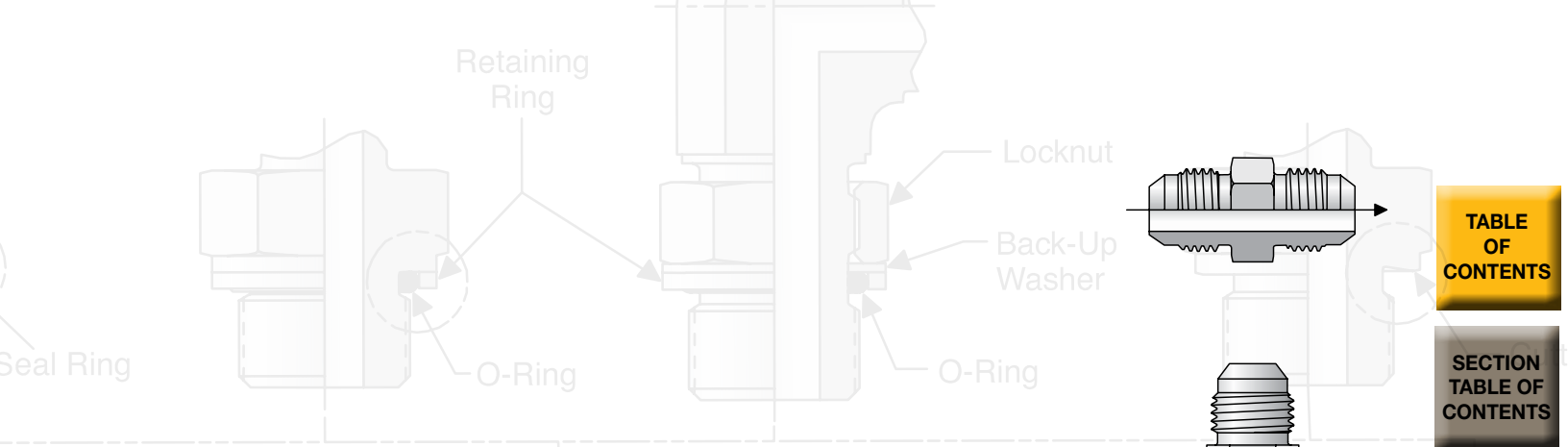
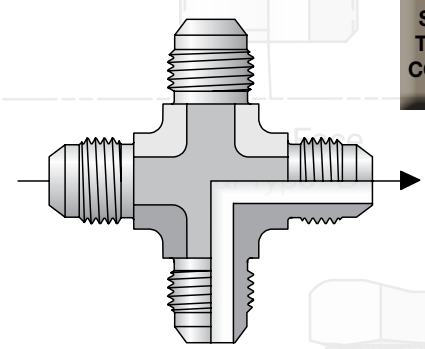


TABLE OF CONTENTS

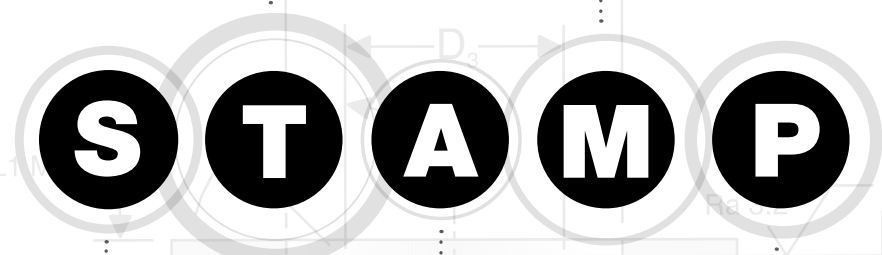
SECTION TABLE OF CONTENTS

O-Ring Rigid Seal Type "G"
O-Ring Adjustable Seal Type "H"



TEMPERATURE

MEDIA



SIZE

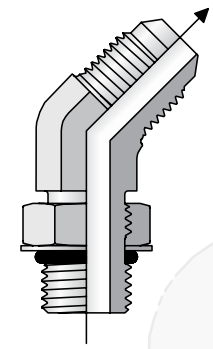
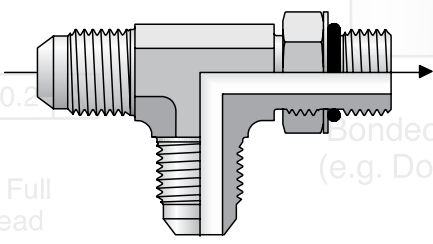
PRESSURE

APPLICATION

Min. Full Thread
2

Bonded Washer (e.g. Dowty) Seal

Thread Pitch Dia.



Special Elastomeric Seal Ring Seal Type "E"

General Technical

T



ENGINEERING YOUR SUCCESS.

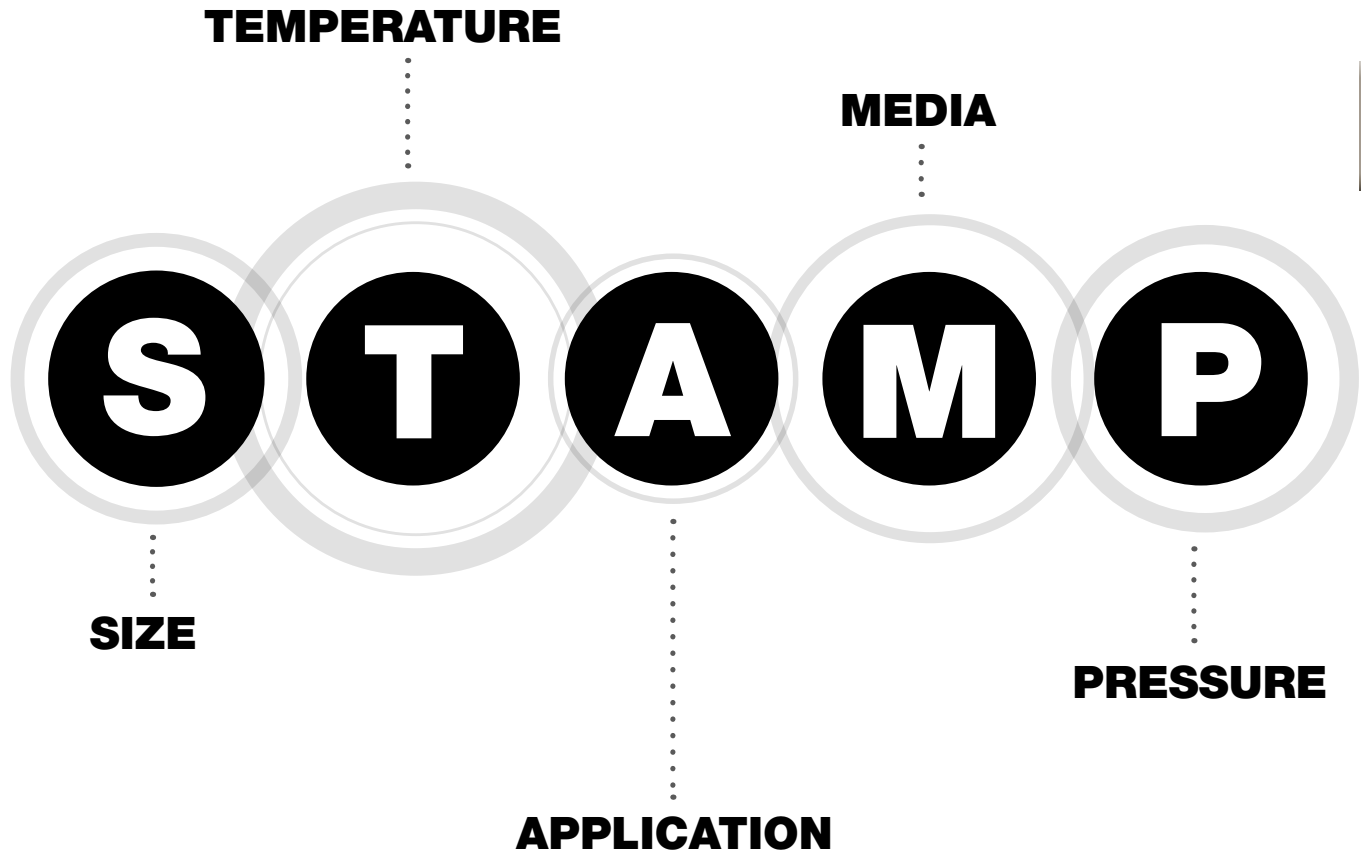
Contents

TABLE
OF
CONTENTS

S	Size	
	Overview.....	T4
	Recommended Flow Diameter — In Inches	T5
	Recommended Flow Diameter — In Millimeters	T6
	Tube Fittings Pressure Drop	T7-T8
T	Temperature	
	Overview.....	T9
	O-Ring Material Selection	T10
A	Application	
	Overview.....	T11
	Tube/Hose End Summary.....	T12
	Port End Summary	T13
	Tube to Port Pairing	T14
	Conformance to Application Specification and Approvals.....	T15
M	Media	
	Fluid Compatibility, Protective Coatings On Steel, Choosing Tube Material and Type.....	T16-T17
	Corrosion of Base Metals In Contact.....	T18
	O-Ring Material Selection	T19-T22
	Tube and Fitting Material Compatibility	T23
P	Pressure	
	Fitting and Adapter Pressure Ratings	T24
	Inch Tube Pressure Ratings	T25-T26
	Metric Tube Pressure Ratings	T27
	Tube Selection Example	T28
	How To Order (TFD Standard Nomenclature Construction)	
	Seal-Lok, Triple-Lok, Ferulok, Intru-Lok, JIS and K4.....	T29
	4-Bolt Hydraulic Flanges.....	T30
	EO and EO-2 Fittings and Accessories	T31
	Port Details	
	ISO 6149-1	T32
	SAE J1926-1	T33
	ISO 6162	T34
	ISO 1179-1.....	T35
	ISO 9974-1.....	T36
	NPTF and BSPT	T37-T38

TABLE
OF
CONTENTS

SECTION
TABLE OF
CONTENTS



Before you spec it **STAMP** it.

When you order fittings and adapters from Parker, remember the word “STAMP.” That way you won’t forget important information! Size, Temperature, Application, Media and Pressure “STAMP” is the process for determining the proper fitting or adaptor selection. Selecting the proper fitting for a given application is an important part of system design.

T



Size



Proper material, type and size of tubing and fittings for a given application is critical for efficient and trouble free operation of the fluid system. Selection of proper tubing and fittings involves determining the correct flow diameter, then selecting the correct material and the optimum tube size (O.D. and wall thickness).

Proper sizing for various parts of a hydraulic system results in an optimum combination of efficient and cost effective performance. A tube or fitting that is too small causes high fluid velocity, which has many detrimental effects. In suction lines, it causes cavitation which starves and damages pumps. In pressure lines, it causes high friction losses and turbulence, both resulting in high pressure drops and heat generation. High heat accelerates wear in moving parts and rapid aging of seals and hoses, all resulting in reduced component life. High heat generation also means wasted energy, and hence, low efficiency.

Too large of a tube or fitting increases system cost. Thus, optimum sizing is very critical. The following is a simple procedure for sizing of tube and fittings.

Step 1: Determine Required Flow Diameter

Use Tables T1 and T2 to determine recommended flow diameter for the required flow rate and type of line.

The table is based on the following recommended flow velocities:

Pressure lines — 25 ft./sec. or 7.62 meters/sec.

Return lines — 10 ft./sec. or 3.05 meters/sec.

Suction lines — 4 ft./sec. or 1.22 meters/sec.

If you desire to use different velocities than the above, use one of the following formulae to determine the required flow diameter.

Tube I.D. (in.) = 0.64	$\sqrt{\frac{\text{Flow in GPM}}{\text{Velocity in ft./sec.}}}$
OR	
Tube I.D. (in.) = 4.61	$\sqrt{\frac{\text{Flow in liters per minute}}{\text{Velocity in meters/sec.}}}$

The flow diameter will be used in combination with the temperature, application, media and pressure data to determine the proper tube size (O.D. and wall thickness).

NOTE: The tube fitting dash (-) size will be dependent on the tube outside diameter selected based on the S.T.A.M.P. criteria.

Recommended Flow Diameter – In Inches



TABLE OF CONTENTS

SECTION TABLE OF CONTENTS

Maximum Flow Rate GPM	Recommended Flow Diameter in Inches		
	Pressure Lines	Return Lines	Suction Lines
0.25	0.064	0.101	0.160
0.50	0.091	0.143	0.226
0.75	0.111	0.175	0.277
1.00	0.128	0.202	0.320
1.25	0.143	0.226	0.358
1.50	0.157	0.247	0.392
1.75	0.169	0.267	0.423
2.00	0.181	0.286	0.453
2.50	0.202	0.319	0.506
3.00	0.222	0.350	0.554
3.50	0.239	0.378	0.599
4.00	0.256	0.404	0.640
4.50	0.272	0.429	0.679
5.00	0.286	0.452	0.716
5.50	0.300	0.474	0.750
6.00	0.314	0.495	0.784
6.50	0.326	0.515	0.816
7.00	0.339	0.534	0.847
7.50	0.351	0.553	0.876
8.00	0.362	0.571	0.905
8.50	0.373	0.589	0.933
9.00	0.384	0.606	0.960
9.50	0.395	0.623	0.986
10.00	0.405	0.639	1.012
11.00	0.425	0.670	1.061
12.00	0.443	0.700	1.109
13.00	0.462	0.728	1.154
14.00	0.479	0.756	1.197
15.00	0.496	0.782	1.239
16.00	0.512	0.808	1.280
17.00	0.528	0.833	1.319
18.00	0.543	0.857	1.358
19.00	0.558	0.880	1.395
20.00	0.572	0.903	1.431
22.00	0.600	0.947	1.501
24.00	0.627	0.990	1.568
26.00	0.653	1.030	1.632
28.00	0.677	1.069	1.693
30.00	0.701	1.106	1.753
32.00	0.724	1.143	1.810
34.00	0.746	1.178	1.866
36.00	0.768	1.212	1.920
38.00	0.789	1.245	1.973
40.00	0.810	1.278	2.024
42.00	0.830	1.309	2.074
44.00	0.849	1.340	2.123
46.00	0.868	1.370	2.170
48.00	0.887	1.399	2.217
50.00	0.905	1.428	2.263
55.00	0.949	1.498	2.373
60.00	0.991	1.565	2.479

Maximum Flow Rate GPM	Recommended Flow Diameter in Inches		
	Pressure Lines	Return Lines	Suction Lines
65.00	1.032	1.629	2.580
70.00	1.071	1.690	2.677
75.00	1.109	1.749	2.771
80.00	1.145	1.807	2.862
85.00	1.180	1.862	2.950
90.00	1.214	1.916	3.036
95.00	1.248	1.969	3.119
100.00	1.280	2.020	3.200
110.00	1.342	2.119	3.356
120.00	1.402	2.213	3.505
130.00	1.459	2.303	3.649
140.00	1.515	2.390	3.786
150.00	1.568	2.474	3.919
160.00	1.619	2.555	4.048
170.00	1.669	2.634	4.172
180.00	1.717	2.710	4.293
190.00	1.764	2.784	4.411
200.00	1.810	2.857	4.525

Table T1 – Recommended Flow Diameters, in Inches

Dimensions and pressures for reference only, subject to change.



Recommended Flow Diameter – In Millimeters



TABLE OF CONTENTS

SECTION TABLE OF CONTENTS

Maximum Flow Rate LPM*	Recommended Flow Diameter in Millimeters		
	Pressure Lines	Return Lines	Suction Lines
1	1.670	2.640	4.180
2	2.362	3.734	5.911
3	2.893	4.573	7.240
4	3.340	5.280	8.360
5	3.734	5.903	9.347
6	4.091	6.467	10.239
7	4.418	6.985	11.059
8	4.723	7.467	11.823
9	5.010	7.920	12.540
10	5.281	8.348	13.218
12	5.785	9.145	14.480
14	6.249	9.878	15.640
16	6.680	10.560	16.720
18	7.085	11.201	17.734
20	7.468	11.806	18.694
22	7.833	12.383	19.606
24	8.181	12.933	20.478
26	8.515	13.461	21.314
28	8.837	13.970	22.118
30	9.147	14.460	22.895
32	9.447	14.934	23.646
34	9.738	15.394	24.373
36	10.020	15.840	25.080
38	10.295	16.274	25.767
40	10.562	16.697	26.437
45	11.203	17.710	28.040
50	11.809	18.668	29.557
55	12.385	19.579	31.000
60	12.936	20.449	32.378
65	13.464	21.284	33.700
70	13.972	22.088	34.972
75	14.463	22.863	36.200
80	14.937	23.613	37.387
85	15.397	24.340	38.538
90	15.843	25.045	39.655
95	16.277	25.732	40.742
100	16.700	26.400	41.800
110	17.515	27.689	43.840
120	18.294	28.920	45.790
130	19.041	30.101	47.659
140	19.760	31.237	49.458
150	20.453	32.333	51.194
160	21.124	33.394	52.873
170	21.774	34.421	54.501
180	22.405	35.419	56.081
190	23.019	36.390	57.617
200	23.617	37.335	59.114
220	24.770	39.158	61.999
240	25.872	40.899	64.756
260	26.928	42.569	67.400
280	27.944	44.176	69.945

Maximum Flow Rate LPM*	Recommended Flow Diameter in Millimeters		
	Pressure Lines	Return Lines	Suction Lines
300	28.925	45.726	72.400
320	29.874	47.226	74.774
340	30.793	48.679	77.075
360	31.686	50.090	79.310
380	32.554	51.463	81.483
400	33.400	52.800	83.600
450	35.426	56.003	88.671
500	37.342	59.032	93.468
550	39.165	61.913	98.030
600	40.906	64.667	102.389
650	42.577	67.307	106.570
700	44.184	69.848	110.592
750	45.735	72.299	114.474
800	47.235	74.670	118.228

Table T2 – Recommended Flow Diameters, in Millimeters

*LPM = Liters Per Minute

Dimensions and pressures for reference only, subject to change.



Tube Fittings Pressure Drop.....



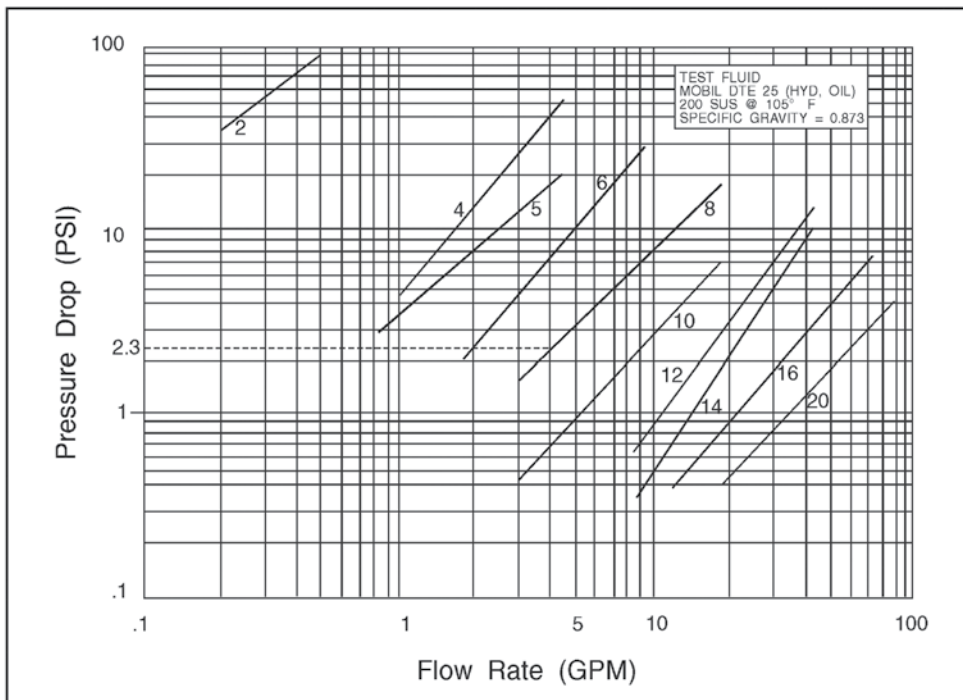
In hydraulic systems, pressure drop represents loss of energy and therefore should be kept to a minimum. Pressure loss in straight tubing and hose is mainly caused by the frictional resistance of the walls, while in fittings it is mainly caused by changes in the magnitude or direction of the fluid velocity. Mathematical analysis of pressure drop, even though possible, may not be exact because of the interrelationship of factors such as fluid density, velocity, flow area and frictional coefficients.

The following pressure drop charts were derived from actual test data and may be used as a guide for determining pressure

drops at various flow rates through fittings for fluid indicated. To determine pressure drop for a given flow, trace a vertical line up from the flow axis to the desired size line then trace a horizontal line from this intersection over to the pressure drop axis.

Example: A size 8 CTX, with oil, similar to the test fluid, flowing through it at 4 gallons per minute, would cause a pressure drop of approximately 2.3 psi. Conversions will have to be made for fluids which are not similar to test fluid.

The Tube Fittings part numbers are listed below the Pressure Drop Chart to which they apply.



Examples:

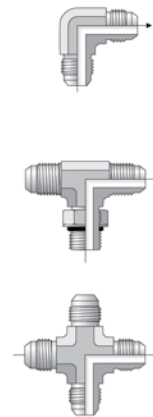


Fig. T3 – Pressure Drop Chart for 90° Fittings or Branch Path Through a Tee or Cross Fitting (Triple-Lok)

Pressure Drops for Other Fitting:

*These pressure drop curves were established with Triple-Lok fittings. The pressure drop values can be adjusted for other fittings of the same size by multiplying the value from the chart by the ratio of Triple-Lok flow diameter to that of the other fitting, raised to the 4th power.

Example: Find pressure drop for 6 C5L at 5 gallons per minute flow rate:
 From the chart, the pressure drop for 6 C5X is 10 psi.
 Also, the ratio of 6 C5X to 6 C5L flow diameters is 0.297/0.264, or 1.125.
 Therefore, the pressure drop for Seal-Lok = 10 x (1.125)⁴ = 16 psi.

Pressure Drops for Other Fluids:

Pressure drop through a fitting is mainly caused by change in direction and velocity of the fluid. Therefore, it is directly proportional to the specific gravity of the fluid. The drop due to friction, which is dependent on the viscosity of the fluid, is so small in this case that it can be ignored. Thus, the pressure drop with a different fluid can be calculated by multiplying the value from the graph above by the ratio of specific gravity of the two fluids, or:

$$\text{New Drop} = \text{Value from the graph} \times \frac{\text{Specific Gravity of New Fluid}}{\text{Specific Gravity of Test Fluid (0.873)}}$$

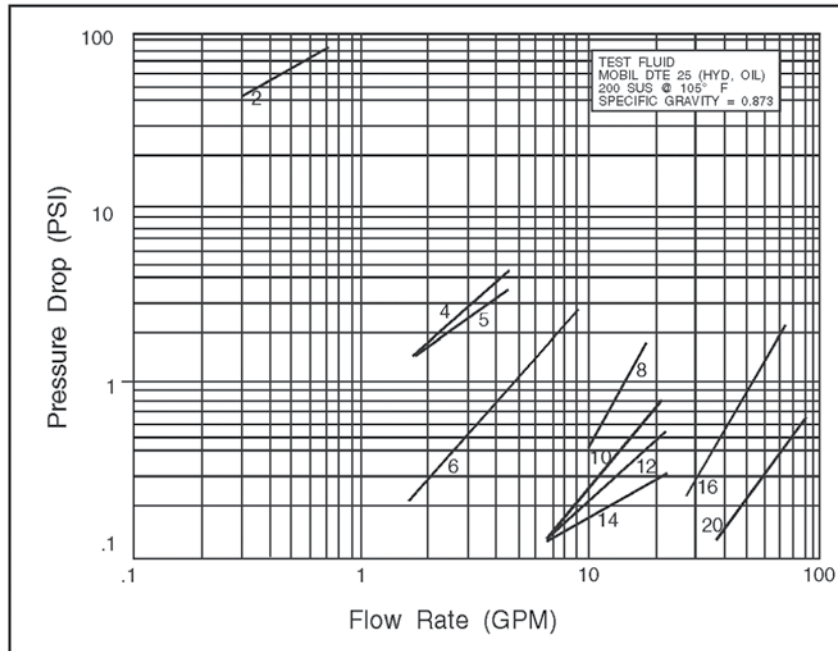
Dimensions and pressures for reference only, subject to change.





TABLE OF CONTENTS

SECTION TABLE OF CONTENTS



Examples:

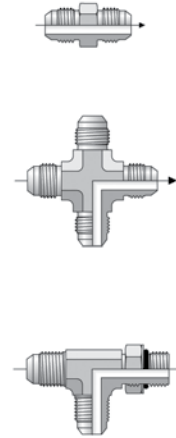
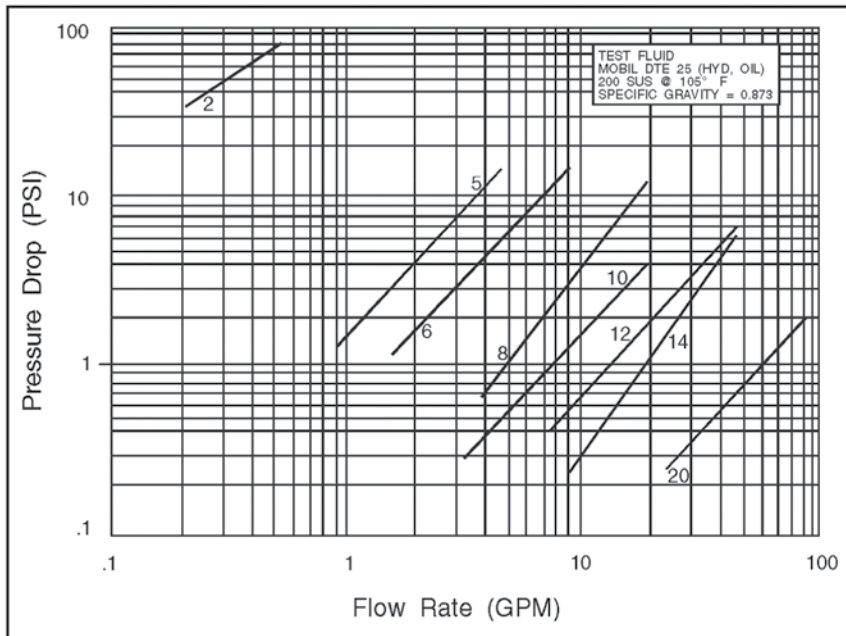


Fig. T4 – Pressure Drop Chart for Straight Fittings and Run Legs of Tees and Crosses (Triple-Lok)



Example:



Fig. T5 – Pressure Drop Chart for 45° Elbow Fittings (Triple-Lok)

Dimensions and pressures for reference only, subject to change.

Temperature



Temperature Ratings For Common Tube Materials

Tube Material	Specification	Construction	Condition	Max. Hardness	Temperature Range (7)
Carbon Steel C-1010	SAE J524 (ASTM A179) (8)	Seamless	Fully Annealed	HRB 72	-65° to 500°F -55° to 260°C
	SAE J525 (ASTM A178) (8)	Welded & Drawn			
	SAE J356	Welded & Flash Controlled			
Carbon Steel C-1021	SAE J2467	Welded & Flash Controlled	Fully Annealed	HRB 75	-65° to 500°F -55° to 260°C
	SAE J2435	Welded & Drawn			
Carbon Steel High Strength Low Alloy (HSLA)	SAE 2613	Welded & Flash Controlled	Sub-critically annealed	HRB 90	-65° to 500°F -55° to 260°C
	SAE J2614	Welded & Drawn			
Alloy Steel 4130	ASTM A519	Seamless			-65° to 500°F -55° to 260°C
St 37.4 (Carbon Steel)	DIN 2391 Part 2 (Metric)	Seamless	Fully Annealed	HRB 72	-65° to 500°F -55° to 260°C
Stainless Steel 304 & 316	ASTM A213 ASTM A269	Seamless	Fully Annealed	HRB 90	-425° to 1200° -255° to 650°C (3)
	ASTM A249 ASTM A269	Welded & Drawn			
1.4571 1.4541 Stainless Steel	DIN 17458 Tab 8 (Metric)	Seamless	Fully Annealed	HRB 90	-425° to 1200° -255° to 650°C (3)
Copper	SAE J528 (ASTM B-75) (8)	Seamless	Soft Annealed Temper 0	60 Max. Rockwell 15T	-325° to 400°F -200° to 205°C
Aluminum 6061	ASTM-B210	Seamless	T6 Temper	HRB 56	-325° to 400°F -200° to 205°C
			0 & T4 Temper	HRB 30	
Monel 400	ASTM-B165	Seamless	Fully Annealed	HRB 70	-400° to 800°F -240° to 425°C
Nylon		Extruded	Flexible & Semi-Rigid		-60° to 200°F -50° to 95°C
Polyethylene	ASTM D-1248	Extruded	Instrument Grade		-80° to 150°F -60° to 65°C
PVC		Extruded	Instrument & Laboratory Grade		0° to 140°F -20° to 60°C
PFTE		Extruded & Cinkered			-65° to 400°F -55° to 205°C

Table T6 – Temperature Ratios for Common Tube Materials

Tube Derating Factors for Temperature

Besides severity of service, high operating temperature also reduces allowable working pressure of the tubing. Temperature derating factors for various tube materials are given in Table T7. Where applicable, derating factors for severity of service and temperature should be applied to the design pressure values in Tables T17 and T18 to arrive at the maximum recommended working pressure.

Example: Combined derating factor for 316SS tubing for B (severe) service and 500°F. operation is .67 x .9 = .603

Tube Selection Example:

*The derating factors are based on allowable design stress values at various temperatures per ASME B31.1 code for pressure piping (1986).

Maximum Operating Temperature	Steel C-1010 and C-4130	Stainless Steel		Copper	Aluminum 6061-T6	Monel Type 4000
		304	316			
100	1.00	1.00	1.00	1.00	1.00	1.00
150	1.00	0.91	1.00	0.85	1.00	0.97
200	1.00	0.84	1.00	0.80	1.00	0.94
250	1.00	0.79	1.00	0.80	0.94	0.91
300	1.00	0.75	1.00	0.78	0.80	0.88
350	0.99	0.72	0.99	0.67	0.60	0.86
400	0.98	0.69	0.97	0.50	0.43	0.85
500	0.96	0.65	0.90			0.84
600		0.61	0.85			0.84
700		0.59	0.82			0.84
800		0.57	0.80			0.83
900		0.54	0.78			
1000		0.52	0.77			
1100		0.47	0.62			
1200		0.32	0.37			

Table T7 – Temperature Derating Factors* for Tubes



O-Ring Material Selection.....



TABLE OF CONTENTS

SECTION TABLE OF CONTENTS

Standard O-Rings supplied with Parker tube fittings and adapters are 90 durometer hard nitrile (Buna-N) Parker compound #N0552 or similar. These O-Rings are well suited for most industrial hydraulic and pneumatic systems. They have high extrusion resistance making them suitable for very high pressure static applications. Optional high temperature fluorocarbon, Parker compound #V0894, is also available for higher temperature specifications.

O-Rings for other than normal hydraulic media or higher temperature applications can be selected from the following chart. The chart should be used only as a general guide. Before making final selection for a given application, it is recommended that appropriate tests be conducted to assure compatibility with the fluid, temperature, pressure and other environmental conditions.

For fluids not shown in the chart, please contact the Tube Fittings Division.

Polymer	Abbreviated Name	Parker Compound No.	Color	SAE j515 Type	Hardness Shore "A" ⁷⁾	Temperature Range (°F)	Recommended For	Not Recommended For
Nitrile-Butadiene	NBR	N0552	Black	CH ²⁾	90 ⁶⁾	-30° to 250°	Petroleum base oils and fluids, mineral oils, ethylene glycol base fluids, silicone and di-ester base lubricants, air, water under 150°F, and natural gas.	Phosphate ester base hydraulic fluids, automotive brake fluids, strong acids, ozone, freons, ketones, halogenated hydrocarbons, and methanol.
Nitrile-Butadiene	NBR	N0674	Black	—	70	-30° to 250°		
Nitrile-Butadiene	NBR	N0103	Black	—	70	-65° to 225°		
Nitrile-Butadiene (Low compression set)	NBR	N1059	Black	CH ²⁾	90	-30° to 275°	Hydrogen fuel cells. Meets FDA requirements for food products.	
Nitrile-Butadiene	NBR	N0507	Black	—	90	-65° to 180°		
Nitrile-Butadiene	NBR	N0304	Black	—	75	-65° to 225°		
Nitrile-Butadiene	NBR	N0508	Black	—	—	-35° to 250°		
Nitrile-Butadiene	NBR	N0756	Black	—	75 ⁶⁾	-65° to 275°	CNG Applications	
Ethylene-Propylene	EPDM	E0540	Black	CA ³⁾	80	-65° to 275°	Phosphate ester base hydraulic fluids, hot water, steam to 400°F, silicone oils and greases, dilute acids and alkalis, ketones, alcohols and automotive brake fluids.	Petroleum base oils and di-ester base lubricants.
Ethylene-Propylene	EPDM	E0893	Purple ¹⁾	CA ³⁾	80	-65° to 275°		
Ethylene-Propylene	EPDM	E0962	Black	—	90	-65° to 275°	CO2 climate control systems.	
Neoprene	CR	C0873	Black	—	70	-45° to 250°	Refrigerants (freons, ammonia), high aniline point petroleum oils, mild acids, and silicate ester lubricants.	Phosphate ester fluids and ketones.
Neoprene	CR	C0944	Red ¹⁾	—	70	-45° to 250°		
Fluorocarbon	FKM ⁵⁾ or FPM	V0747 V0884 V0894	Black Brown ¹⁾ Brown ^{1), 5)}	— — HK ⁴⁾	75 75 90 ⁶⁾	-15° to 400° -15° to 400° -15° to 400°	Petroleum base oils and fluids, some phosphate ester base fluids, silicone and silicate ester base lubricants, di-ester base lubricants, acids and halogenated hydrocarbons.	Ketones, skydrol fluids, amines (VDMH), anhydrous ammonia, low molecular weight esters and ethers, and hot hydrofluoric or chlorosulfonic acids.
Silicone	Si	S0604	Rust ¹⁾	—	70	-65° to 450°	Dry heat (air to 400°F) and high aniline point oils.	Most petroleum fluids, ketones, water and steam.

Table T8 – O-Ring Selection

- 1) These Parker "Chromasure" color assurance O-Rings are available from the Parker Hannifin O-Ring Division. They help eliminate assembly errors, reduce warranty costs and liability risks, and assure safety in aftermarket business.
- 2) Formerly SAE Type I.
- 3) Formerly SAE Type II.
- 4) Formerly SAE Type III.
- 5) "FKM" is the ASTM designation for fluorocarbon. Its ISO designation is "FPM". For "DIN" Fittings, color is green.
- 6) Standard compounds available from stock.
- 7) Use 90 durometer hard O-Rings for applications with 1500 psi or higher pressures.

Dimensions and pressures for reference only, subject to change.



Application



Connector Proliferation

Today many different types of connectors are being used around the world. Most of these have come about through historical use and local preference for a certain design concept. Some connections of the North American origin such as four bolt flange, SAE straight thread and 37° Flare have found some degree of acceptance and use in Europe and Japan as a result of the exports of U.S. machinery to the regions after World War II. But, large majority of usage is made up of a variety of indigenous port and tube connections. A quick review of the commonly used connections around the world reveals that there are eight different port connections and eleven different tube/hose connections.

Port Connections

NPTF	ISO 6149 (Metric Straight Thread O-Ring Port)
SAE Straight Thread (UN/UNF)	JIS-PT (BSPT)
4-Bolt Flange	JIS-B2351 (BSPP similar to SAE)
ISO 1179 (BSPP)	
ISO 9974 (Metric)	

Tube/Hose Connections:

37° Flare (SAE)	30° Flare, BSPP (JIS)
24° Flareless, Inch Threads (SAE)	24° Flareless, Metric (JIS)
60° Cone Swivel, NPSM (SAE)	60° Cone, BSPP (JIS)
O-Ring Face Seal (SAE)	60° Cone, Metric (JIS)
24° Cone, Metric (DIN)	37° Flare, Metric (Russia)
60° Cone, BSPP (BSi)	

The Challenge

Leakage is no longer acceptable in world class products. Above proliferation, besides limiting availability and increasing cost, increases leakage potential through misapplications. Therefore, the challenge facing the fluid power industry is two fold — eliminate leakage and minimize proliferation.

Meeting The Challenge

This challenge has been met through a very intensive and cooperative effort by the member nations of

sub-committee 4 of the ISO Technical Committee 131 (ISO/TC131) The sub-committee started this effort in 1989 and has completed development of performance based standards for the most widely used ports and tube/hose connections to limit proliferation, and strongly endorsing those with elastomeric seals to eliminate leakage in hydraulic systems.

Ten ports, eight threaded and two four bolt flange, and four tube/hose connections as shown on page T12 have been standardized. The threaded ports and tube/hose connections are paired in the ISO 8434 series of fitting standards as defined in the table below.

To minimize proliferation in port usage and promote leak free connections, the sub-committee strongly endorses use of ISO 6149 port for all new designs by including the following statement in all port standards:

“For threaded ports and stud ends specified in new designs in hydraulic fluid power applications, only ISO 6149 shall be used. Threaded ports and stud ends in accordance with ISO 1179, ISO 9974 and ISO 11926 shall not be used for new designs in hydraulic fluid power applications.”

On the tube/hose connection side, only ISO 8434-3 (O-Ring Face Seal) and ISO 8434-4 (24° cone with weld nipple) feature elastomeric seal for zero leak performance. Combining these with the ISO 6149 for the port connection leads to two (2) combinations (complete fittings) for use in leak-free world class products. They are:

ISO 8434-3	O-Ring Face Seal and ISO 6149 Port
ISO 8434-4	24° Cone With Soft Seal and ISO 6149 Port

For large port connections, the four bolt flange connection per ISO 6162 (SAE J518 is included in ISO 6162) remains widely used and the recommended connection.

Application	Port	Tube/Hose Connection			
		24° Cone Flareless (DIN) (Bite Type)	37° Flare (Inch Threads)	ORFS	24° Cone Weld Nipple
For All Designs	Metric ISO 6149 (SAE J2244)	ISO 8434-1	ISO 8434-2	ISO 8434-3	ISO 8434-4*
Not for New Designs in Hydraulic Fluid Power	Metric ISO 1179 (DIN 3852-2)	ISO 8434-1	ISO 8434-2	--	ISO 8434-4*
	Metric ISO 9974 (DIN 3852-1)	ISO 8434-1	--	--	ISO 8434-4*
	UN/UNF ISO 11926 (SAE J1926)	--	ISO 8434-2	--	--

Table T9 – ISO Standard Port and Tube/Hose Connection Combinations

*Will be included in ISO 8434-1 at the next revision.

Dimensions and pressures for reference only, subject to change.



Tube/Hose End Summary.....



TABLE OF CONTENTS

SECTION TABLE OF CONTENTS

Tube/Hose End Type	Illustration	Pressure – Dynamic	Pressure – Static	Seal Reliability	Vibration Resistance (in Rigid Systems)	Ease of Installation	Ease of Maintenance	Reusability	Temperature
Seal-Lok O-Ring Face Seal		Excellent	Excellent	Excellent	Very Good	Excellent	Excellent	Excellent	Limited by Seal
Triple-Lok 37° Flare		Very Good	Very Good	Good	Good	Good	Very Good	Good	Excellent
Ferulok Inch Bite Type		Very Good	Very Good	Very Good	Very Good	Good	Good	Very Good	Excellent
EO Metric Bite Type		Excellent	Excellent	Very Good	Very Good	Good	Good	Very Good	Excellent
EO-2 Soft Seal Metric Bite Type		Excellent	Excellent	Excellent	Very Good	Very Good	Good	Excellent	Limited by Seal
Intru-Lok Brass Flareless		Fair (Low)	Fair (Low)	Very Good	Good	Good	Good	Good	Excellent
JIS 30° Flare		Good	Good	Very Good	Not Applicable	Very Good	Very Good	Very Good	Limited by Seal
JIS 60° Cone B8363		Good	Good	Very Good	Not Applicable	Very Good	Very Good	Very Good	Limited by Seal
Komatsu 30° Flare		Good	Good	Very Good	Not Applicable	Very Good	Very Good	Very Good	Limited by Seal
K4 BSP Adapters		Good	Good	Very Good	Not Applicable	Very Good	Very Good	Very Good	Limited by Seal
NPSM (Swivel)		Good	Good	Very Good	Not Applicable	Good	Good	Very Good	Limited by Seal

Dimensions and pressures for reference only, subject to change.



Port End Summary.....



TABLE OF CONTENTS

SECTION TABLE OF CONTENTS

Port End Type and Seal Style	Illustration	Pressure – Dynamic	Pressure – Static	Temperature	Positioning	Contamination	Seal Reliability	Reusability	Fluid Compatibility
Tapered (NPT, NPTF, BSPT and Metric Taper)		Poor	Good	Excellent	Poor	Poor	Poor	Poor	Excellent
O-Ring in Chamfer (SAE J1926, ISO 6149 and JIS B2351)		Excellent	Excellent	Limited by Seal	Excellent	Very Good	Excellent	Excellent	Limited by Seal
Spot Face with ED Seal (ISO 1179-2 and ISO 9974-2)		Excellent	Excellent	Limited by Seal	Not Applicable	Very Good	Excellent	Excellent	Limited by Seal
Spot Face with Bonded Seal (ISO 1179 and ISO 9974)		Good	Good	Good	Not Applicable	Very Good	Good	Excellent	Limited by Seal
Spot Face with Cutting Face (ISO 1179-4 and ISO 9974-3)		Poor	Fair	Excellent	Not Applicable	Fair	Poor	Poor	Excellent
Spot Face with O-Ring and Retaining Ring (ISO 1179-3)		Good	Good	Good	Excellent	Very Good	Good	Excellent	Limited by Seal
Spot Face with Hard Metal Seal (ISO 1179 and ISO 9974)		Poor	Fair	Excellent	Not Applicable	Fair	Poor	Poor	Excellent
Spot Face with Soft Metal Seal (ISO 1179 and ISO 9974 with copper gasket)		Poor	Fair	Good	Not Applicable	Very Good	Poor	Fair	Excellent
4 Bolt Flange (SAE J518 and ISO 6162)		Excellent	Excellent	Good	Good	Very Good	Good	Excellent	Limited by Seal
4 Bolt Flange (ISO 6164)		Excellent	Excellent	Good	Good	Good	Good	Excellent	Limited by Seal



Dimensions and pressures for reference only, subject to change.



Tube to Port¹⁾ Pairing for Medium Pressure²⁾ Applications



TABLE OF CONTENTS

SECTION TABLE OF CONTENTS

Tube O.D.			Port Thread			
Inch (Dash Size)		Metric (mm.)	SAE	ISO	NPTF	BSPP
1/8	(-2)	4	5/16-24	M8 x 1	1/16-27	G 1/8-28
3/16	(-3)	5	3/8-24	M10 x 1	1/8-27	G 1/8-28
1/4	(-4)	6	7/16-20	M10 x 1	1/8-27	G 1/8-28
5/16	(-5)	8	1/2-20	M12 x 1.5	1/8-27	G 1/4-19
3/8	(-6)	10	9/16-18	M14 x 1.5	1/4-18	G 1/4-19
1/2	(-8)	12	3/4-16	M16 x 1.5	3/8-18	G 3/8-19
—		15	3/4-16	M18 x 1.5	1/2-14	G 1/2-14
5/8	(-10)	16, 18	7/8-14	M22 x 1.5	1/2-14	G 1/2-14
3/4	(-12)	20	1 1/16-12	M27 x 2	3/4-14	G 3/4-14
7/8	(-14)	22	1 3/16-12	M27 x 2	3/4-14	G 3/4-14
1	(-16)	25, 28	1 5/16-12	M33 x 2	1-11 1/2	G 1-11
1 1/4	(-20)	30, 35	1 5/8-12	M42 x 2	1 1/4-11 1/2	G 1 1/4-11
1 1/2	(-24)	38, 42	1 7/8-12	M48 x 2	1 1/2-11 1/2	G 1 1/2-11
2	(-32)	50	2 1/2-12	M60 x 2	2-11 1/2	G 2-11

Table T10 – Tube to Port Pairing for Medium Pressure Applications

- 1) Ports are in accordance with the standards listed below:
SAE J1926-1, ISO 6149-1, NPTF-SAE J476 and BSPP-ISO 1179-1
- 2) The pressure range covering all the sizes shown is 1000 to 5000 PSI.

Tube to Port¹⁾ Pairing for High Pressure²⁾ Applications

Tube O.D.			Port Thread			
Inch (Dash Size)		Metric (mm.)	SAE	ISO	NPTF	BSPP
1/8	(-2)	4	5/16-24	M8 x 1	1/16-27	G 1/8-28
3/16	(-3)	5	3/8-24	M10 x 1	1/8-27	G 1/8-28
1/4	(-4)	6	7/16-20	M12 x 1.5	1/8-27	G 1/8-28
5/16	(-5)	8	1/2-20	M14 x 1.5	1/8-27	G 1/4-19
3/8	(-6)	10	9/16-18	M16 x 1.5	1/4-18	G 1/4-19
1/2	(-8)	12	3/4-16	M18 x 1.5	3/8-18	G 3/8-19
5/8	(-10)	14, 16	7/8-14	M22 x 1.5	1/2-14	G 1/2-14
3/4	(-12)	20	1 1/16-12	M27 x 2	3/4-14	G 3/4-14
7/8	(-14)	—	1 3/16-12	M30 x 2	3/4-14	G 3/4-14
1	(-16)	25	1 5/16-12	M33 x 2	1-11 1/2	G 1-11
1 1/4	(-20)	30	1 5/8-12	M42 x 2	1 1/4-11 1/2	G 1 1/4-11
1 1/2	(-24)	38	1 7/8-12	M48 x 2	1 1/2-11 1/2	G 1 1/2-11
2	(-32)	50	2 1/2-12	M60 x 2	2-11 1/2	—

Table T11 – Tube to Port Pairing for High Pressure Applications

- 1) Ports are in accordance with the standards listed below:
SAE J1926-1, ISO 6149-1, NPTF-SAE J476 and BSPP-ISO 1179-1
- 2) The pressure range covering all the sizes shown is 2500 to 9000 PSI.

Dimensions and pressures for reference only, subject to change.



Conformance to Applicable Specifications and Approvals A for TFD Products by Product Type or Subject

TABLE OF CONTENTS

SECTION TABLE OF CONTENTS

Fittings	Specifications
Seal-Lok	SAE J1453
Metric Seal-Lok	ISO 8434-3
Triple-Lok	SAE J514
	MIL-F-18866, MS Sheets*
	MS51500 - MS51534*
	BS43687, part 4
Ferulok	ISO 8434-2
	SAE J514
	MIL-F-18866 MS Sheets* MS51811 - MS51843*
	U.S. Coast Guard - meet applicable requirements of ASTM F1387
EO/EO-2	DIN 3861
	ISO 8434-1-4, ISO 8434-4 (former DIN 2353)
	DIN 3865
	DIN 3859
Flange Adapters	SAE J518
	ISO 6162-1
	ISO 6162-2
	ISO 6164
JIS Adapters*	JIS B8363 (with some exceptions)
K4 Adapters	BS 5200, ISO 8434-6*
Pipe Fittings	SAE J514
Pipe Plugs	SAE J531
Straight Thread Plugs	SAE J514
Pipe Swivel Adapters	SAE J514
All catalog products	Canadian Registration

Approvals:

Parker tube fittings are recognized by various acceptance organizations, among which are:

- Germanischer Lloyd (GL)
- Lloyds Register of Shipping (LR)
- Det Norske Veritas (DNV)
- American Bureau of Shipping (ABS)
- Russian Maritime Register of Shipping (RMS)
- China Classification Society (CCS)
- Deutscher Verein des Gas- und Wasserfaches (DVGW)
- Canadian Technical Standards and Safety Registration (CRN)

For other applications, Parker tube fittings also approved by diverse national authorities.

Numerous original equipment manufacturers and end-users of various industries have approved Parker tube fittings.

Attention:

Type Approvals usually are limited to certain products, applications, working conditions, validity time or other restrictions. We will gladly inform you on your individual application and send out the required documentation.

Plating	Specification
Carbon Steel – Chromium 6 Free Zinc	ASTM B633 Type II FE/ZN8** **Clear/Silver Color
	MIL-STD-171E
	JIS 8610 Class 1 Grade 3
Stainless Steel Passivation	QQ-P35 Type VI
	ASTM A380
Carbon Steel – Zinc Phosphate	DOD-P-16232, Class 1

Plating	Specification	Comment
Products	ASME / ANSI B31.1	All products meet the design factor requirements of this specification.

Test Methods	Specification
Leak, Burst, Impulse, Over-Torque and Repeated Assembly	SAE J1644 (cancelled)
	ISO 19879
Vibration	NFPA T3.8.3, ISO 7257

Table T12 – Conformance Standards

*Some parts do not meet dimensional requirements.

Dimensions and pressures for reference only, subject to change.



Media



Fluid Compatibility

The fluid compatibility chart on the following page is intended as a guide only and is not to be considered as a sole selection criteria to use Parker Tube Fittings in a specific application or with a specific fluid. Other factors that must be considered include, but are not limited to: Fluid temperature, ambient temperature, system pressure (both operating and peak) and applicable standards or regulations. For media not listed, please contact your Parker representative or the Tube Fittings Division.

Protective Coatings on Steel

Protective coatings such as electroplated zinc and cadmium¹) and zinc phosphate are usually applied to steel fittings for extending their useful service life in corrosive environments. Cadmium and zinc corrode sacrificially, protecting the steel substrate from normal atmospheric rusting due to the common presence of oxygen, moisture and acidic gases. They are, however, rapidly attacked by many fluids including those containing acidic hydrogen and reactive fluorine, chlorine, bromine, iodine, and nitrogen. **Zinc plating will further be attacked by strong bases or water with pH > 12. Zinc reacts with glycol based fire resistant fluids and forms a gelatinous compound that can plug up filters and be harmful otherwise, in a system with many zinc plated tube and hose fittings.** Steel fittings with zinc phosphate coating or stainless steel fittings, along with brass fittings in low pressure applications, are viable options.

The other option is to run the fluid through the system, without components with moving parts in it, with an auxiliary power source, to generate and flush the gelatinous compound. Then re-connect all components, change filters and charge the system with new fluid.

The corrosion resistance of the Chromium-6 Free standard surface treatment is a minimum of 25% improved over traditional zinc gold (hexavalent) chromate surface. Additionally, the Chromium-6 Free surface meets the EU end of life vehicle directive and ROHS compliance.

Zinc-Nickel (Parker XTR) plating offers enhanced performance over both Chromium-6 Free (standard treatment) and traditional zincgold hexavalent chromate surfaces. Parker XTR plating increases protection in salt spray (ASTM B117) testing and in fertilizer (urea) applications.

Caution: Where low toxicity and low corrosion are required, as in food or beverage applications, steel coated with any form of zinc or other protective coatings is not recommended.

Choosing the Tube Material and Type

Selection of tube material depends on the fluid, corrosive nature of the service environment, the operating temperature range and the maximum operating pressure. The tube O.D. and wall thickness selection depends on these four parameters.

A simple method of selecting the proper tube type and material is described below.

Table T16 lists several common tube types with their recommended operating temperature ranges, general application, and fitting compatibility. Based on the fluid system parameters and media, select the appropriate tube type and material.

If media and/or service environment is different from the commonly used ones listed in the general application column, please consult the Fluid Compatibility chart on the following page or contact the Tube Fittings Division.

For selecting proper tube O.D. and wall thickness use the procedure given on pages T4 and T28.

Caution: When working with highly corrosive media, always consult the Tube Fittings Division.





TABLE OF CONTENTS

SECTION TABLE OF CONTENTS

Media	Fitting Material			Seal Material			
	Brass	Steel	316 SS	BUNA-N	Ethylene Propylene	Fluorocarbon	Neoprene
Acetylene	NR	F	S	S	S	S	F
Air (oil free) @ 190°F	S	F	S	S	S	S	S
Air (oil free) @ 300°F	S	F	S	F	F	S	F
Air (oil free) @ 400°F	S	F	S	NR	NR	S	NR
Alcohol, Ethyl	S	NR	NR	NR	S	NR	S
Animal Oils (Lard Oil)	F	F	F	S	F	S	F
Aromatic Fuel - 50%	ID	ID	ID	F	NR	S	NR
Aromatic Solvents	ID	ID	F	F	ID	S	NR
Asphalt	NR	NR	S	F	NR	S	F
ASTM Oil #1	S	S	S	S	NR	S	S
ASTM Oil #2	S	S	S	S	NR	S	F
ASTM Oil #3	S	S	S	S	NR	S	NR
ASTM Oil #4	S	S	S	F	NR	S	NR
ATF Oil	S	S	S	S	NR	S	F
Automotive Brake Fluid	ID	ID	ID	NR	S	NR	F
Benzene	NR	F	NR	NR	NR	S	NR
Brine (Sodium Chloride)	NR	NR	S	S	S	S	S
Butane	NR	S	S	S	NR	S	S
Carbon Dioxide	S	F	S	S	S	S	S
Carbon Monoxide	S	S	S	S	S	S	F
Chlorine (Dry)	F	F	NR	NR	ID	F	F
Compressed Air	S	F	S	S	S	S	S
Crude Oil	NR	F	S	F	NR	S	NR
Cutting Oil	ID	S	S	S	NR	S	F
Diesel Fuel	S	S	S	S	NR	S	NR
Ethanol	S	NR	S	NR	S	NR	S
Ethers	S	S	S	NR	F	F	NR
Freon 11	S	ID	ID	F	NR	F	NR
Freon 12	S	S	NR	F	NR	S	S
Freon 22	S	NR	S	NR	NR	NR	S
Fuel Oil	NR	S	S	S	NR	S	F
Gasoline	S	F	S	S	NR	S	NR
Gas, Liquid Propane (LPG)	S	S	S	S	NR	S	F
Gas, Natural	F	S	S	S	NR	S	S
Helium	S	S	S	S	S	S	S
Hydraulic Oil, Petroleum Base	S	S	S	S	NR	S	S
Hydraulic Oil, Water Base	ID	S	S	F	S	NR	F
Hydrogen Gas	S	S	S	S	S	S	S
Jet Fuel	S	S	S	S	NR	S	NR
Kerosene	S	S	S	S	NR	S	F
Lubricating Oil SAE 10, 20, 30, 40, 50	S	S	S	S	NR	S	F
Methanol	S	S	S	S	S	NR	S
MIL-F-8192 (JP-9)	S	S	S	NR	NR	S	NR
MIL-H-5606	S	S	S	S	NR	S	F
MIL-H-6083	S	S	S	S	NR	S	S
MIL-H-7083	S	S	S	S	S	F	F
MIL-H-8446 (MLO-8515)	F	S	S	F	NR	S	S
Mil-L-2104 & 2104B	S	S	S	S	NRX	S	F
MIL-L-7808	NR	F	S	S	NR	S	NR
Mineral Oil	S	S	S	F	NR	S	F
Nitrogen	S	S	S	F	S	S	S
Petrolatum	S	S	S	S	NR	S	F
Petroleum Oil (<250°F)	S	S	S	S	NR	S	F
Propane	S	S	S	S	NR	S	F
R134A	S	S	S	NR	S	NR	NR
Sea Water	F	NR	S	S	S	S	F
Skydrol 500, Type 2	NR	S	S	NR	S	NR	NR
Skydrol 7000, Type 2	NR	S	S	NR	S	F	NR
Soap Solutions	NR	NR	S	S	S	S	F
Steam (<400°F)	F	S	S	NR	S	NR	NR
Stoddard Solvent	F	S	S	S	NR	S	F
Transmission Fluid (Type A)	S	S	S	S	NR	S	F
Trichloroethane	ID	F	S	NR	NR	S	NR
Water	S	F	S	S	S	F	F

Table T13 – Fluid Compatibility Chart Codes: S = Satisfactory F = Fair NR = Not recommended ID = Insufficient Data
Dimensions and pressures for reference only, subject to change.



T

Corrosion of Base Metals in Contact



TABLE OF CONTENTS

SECTION TABLE OF CONTENTS

The susceptibility of different base metals to corrosion while incontact, depends upon the difference between the contact potentials, or the electromotive voltages of the metals involved. The greater the potential difference is, the greater is the tendency for corrosion. The metal with the higher potential forms the anode and is corroded. In other words, the larger the separation distance in the electromotive chart between the two metals in contact, the higher the contact potential and chances for corrosion. For example, zinc and aluminum are very short distance apart in the chart;

therefore potential for corrosion when these two metals are in contact is very low. On the other hand, aluminum and passivated 316 stainless steel are far apart; hence, when in contact, the potential for corrosion is very high. Aluminum, being more anodic metal, will corrode in this combination.

As a general guideline, if the metals are half the length of the chart or more apart, the combination should be avoided. Also, it is not a good idea to combine an anodic metal part with thin cross section, such as thin wall tubing, with a cathodic or less anodic metal part of a heavy cross section, such as a fitting.

Example: A thin wall brass tube with steel fitting is a better, although not ideal, combination than a thin wall steel tube with brass fitting.

Electromotive or Galvanic Series for Metals	
+ Anodic (least noble) corroded ↑ Electric current flows from plus to minus Direction of attack ↓ - Cathodic (most noble) protected	Magnesium
	Magnesium Alloys
	Zinc (Parker steel fittings are zinc plated)
	Zinc-Nickel (Parker XTR Plating)
	Beryllium
	Aluminum 5052, 3004, 3003, 1100, 6053
	Cadmium
	Aluminum 2117, 2017, 2024 T4
	Mild steel (1018), wrought iron, free machining steel (12L14)
	Low alloy high strength steel, cast iron
	Chrome iron (active)
	430 Stainless (active)
	302, 303, 321, 347, 410, 416, stainless steel (active)
	Ni-resist
	316, 317 stainless steel (active)
	Carpenter 20Cb-3 stainless (active)
	Aluminum bronze (CA 687)
	Hastelloy C (active) Inconel 625 (active) Titanium (active)
	Lead/Tin solder
	Lead
	Tin
	Inconel 600 (active)
	Nickel (active)
	60 Ni-15 Cr (active)
	80 Ni-20 Cr (active)
	Hastelloy B (active)
	Naval brass (CA 464), Yellow brass (CA 268), Brass (CA360)
	Red brass (CA 230), Admiralty brass (CA 443)
	Copper (CA 102)
	Maganese bronze (CA 675), Tin bronze (CA 903, 905)
	410, 416 Stainless (passive) Phosphor bronze (CA 521, 524)
	Silicon bronze (CA 651, 655)
	Nickel silver (CA 732, 735, 745, 752, 754, 757, 764, 770, 794)
	Cupro Ni 90-10
	Cupro Ni 80-20
	430 Stainless steel (passive)
	Cupro Ni 70-30
	Nickel aluminum bronze (CA 630, 632)
	Monel 400, K500
	Silver solder
Nickel (passive)	
60 Ni 15 Cr (passive)	
Inconel 600 (passive)	
80 Ni 20 Cr (passive)	
Chrome iron (passive)	
302, 303, 304, 321, 347 stainless steel (passive)	
316, 317 stainless steel (passive) (Parker stainless steel fittings are passivated)	
Carpenter 20 Cb-3 stainless (passive), Incoloy 825	
Silver	
Titanium (passive), Hastelloy C & C276 (passive), Inconel 625 (passive)	
Graphic	
Zirconium	
Gold	
Platinum	

Table T14 – Electromotive or Galvanic Series for Metals



O-Ring Material Selection.....



Standard O-Rings supplied with Parker tube fittings and adapters are 90 durometer hard nitrile (Buna-N) Parker compound #N0552 or similar. These O-Rings are well suited for most industrial hydraulic and pneumatic systems. They have high extrusion resistance making them suitable for very high pressure static applications. Optional high temperature fluorocarbon, Parker compound #V0894, is also available for higher temperature specifications.

O-Rings for other than normal hydraulic media or higher temperature applications can be selected from the following chart. The chart should be used only as a general guide. Before making final selection for a given application, it is recommended that appropriate tests be conducted to assure compatibility with the fluid, temperature, pressure and other environmental conditions.

For fluids not shown in the chart, please contact the Tube Fittings Division or Parker Seal Group.



Recommended for	Temperature Range	Not Recommended For	Polymer	Abbreviated Name	Parker Compound	No. Color	SAE J515 Type	Shore Hardness
Acids	-15° to 400°F	Ketones, skydrol fluids, amines (VDMH), anhydrous ammonia, low molecular weight esters and ethers, hot hydrofluoric or chlorosulfuric acids	Fluorocarbon	FKM ⁵⁾ or FPM	V0747	Black	—	75
Acids	-15° to 400°F	Ketones, skydrol fluids, amines (VDMH), anhydrous ammonia, low molecular weight esters and ethers, hot hydrofluoric or chlorosulfuric acids	Fluorocarbon	FKM ⁵⁾ or FPM	V0884	Brown ¹⁾	—	75
Acids	-15° to 400°F	Ketones, skydrol fluids, amines (VDMH), anhydrous ammonia, low molecular weight esters and ethers, hot hydrofluoric or chlorosulfuric acids	Fluorocarbon	FKM ⁵⁾ or FPM	V0894	Brown ^{1),5)}	HK ⁴⁾	90 ⁶⁾
Air	-30° to 250°	Phosphate ester base hydraulic fluids, automotive brake fluids, strong acids, ozone, freons, ketones, halogenated hydrocarbons and methanol	Nitrile-Butadiene	NBR	N0674	Black	—	70
Air	-30° to 250°F	Phosphate ester base hydraulic fluids, automotive brake fluids, strong acids, ozone, freons, ketones, halogenated hydrocarbons and methanol	Nitrile-Butadiene	NBR	N0552	Black	CH ²⁾	90 ⁶⁾
Air	-30° to 275°F	Phosphate ester base hydraulic fluids, automotive brake fluids, strong acids, ozone, freons, ketones, halogenated hydrocarbons and methanol	Nitrile-Butadiene	NBR	N1059	Black	CH ²⁾	90
Air	-65° to 225°	Phosphate ester base hydraulic fluids, automotive brake fluids, strong acids, ozone, freons, ketones, halogenated hydrocarbons and methanol	Nitrile-Butadiene	NBR	N0103	Black	—	70
Alcohols	-65° to 225°F	Petroleum based oils and di-ester base lubricants	Ethylene-Propylene	EPDM	E0540	Black	CA ³⁾	80
Alcohols	-65° to 225°F	Petroleum based oils and di-ester base lubricants	Ethylene-Propylene	EPDM	E0893	Purple ¹⁾	CA ³⁾	80
Automotive brake fluids	-65° to 225°F	Petroleum based oils and di-ester base lubricants	Ethylene-Propylene	EPDM	E0540	Black	CA ³⁾	80
Automotive brake fluids	-65° to 225°F	Petroleum based oils and di-ester base lubricants	Ethylene-Propylene	EPDM	E0893	Purple ¹⁾	CA ³⁾	80
CO2 Climate control systems	-65° to 225°F	Petroleum based oils and di-ester base lubricants	Ethylene-Propylene	EPDM	E0962	Black	—	90
CNG Applications	-65° to 225°F	Phosphate ester base hydraulic fluids, automotive brake fluids, strong acids, ozone, freons, ketones, halogenated hydrocarbons and methanol	Nitrile-Butadiene	NBR	N0756	Black	—	75 ⁶⁾
Di-ester base lubricants	-15° to 400°F	Ketones, skydrol fluids, amines (VDMH), anhydrous ammonia, low molecular weight esters and ethers, hot hydrofluoric or chlorosulfuric acids	Fluorocarbon	FKM ⁵⁾ or FPM	V0747	Black	—	75
Di-ester base lubricants	-15° to 400°F	Ketones, skydrol fluids, amines (VDMH), anhydrous ammonia, low molecular weight esters and ethers, hot hydrofluoric or chlorosulfuric acids	Fluorocarbon	FKM ⁵⁾ or FPM	V0884	Brown ¹⁾	—	75
Di-ester base lubricants	-15° to 400°F	Ketones, skydrol fluids, amines (VDMH), anhydrous ammonia, low molecular weight esters and ethers, hot hydrofluoric or chlorosulfuric acids	Fluorocarbon	FKM ⁵⁾ or FPM	V0894	Brown ^{1),5)}	HK ⁴⁾	90 ⁶⁾
Dilute acids and alkalis	-65° to 275°F	Petroleum based oils and di-ester base lubricants	Ethylene-Propylene	EPDM	E0540	Black	CA ³⁾	80
Dilute acids and alkalis	-65° to 275°F	Petroleum based oils and di-ester base lubricants	Ethylene-Propylene	EPDM	E0893	Purple ¹⁾	CA ³⁾	80
Dry heat (air to 400°F)	-65° to 450°F	Most petroleum fluids, ketones, water and steam	Silicone	Si	S0604	Rust ¹⁾	—	70
Ethylene glycol base fluids	-30° to 250°	Phosphate ester base hydraulic fluids, automotive brake fluids, strong acids, ozone, freons, ketones, halogenated hydrocarbons and methanol	Nitrile-Butadiene	NBR	N0674	Black	—	70

Dimensions and pressures for reference only, subject to change.





TABLE OF CONTENTS

SECTION TABLE OF CONTENTS

Recommended for	Temperature Range	Not Recommended For	Polymer	Abbreviated Name	Parker Compound	No. Color	SAE J515 Type	Shore Hardness
Ethylene glycol base fluids	-30° to 250°F	Phosphate ester base hydraulic fluids, automotive brake fluids, strong acids, ozone, freons, ketones, halogenerated hydrocarbons and methonal	Nitrile-Butadiene	NBR	N0552	Black	CH ²⁾	90 ⁶⁾
Ethylene glycol base fluids	-30° to 275°F	Phosphate ester base hydraulic fluids, automotive brake fluids, strong acids, ozone, freons, ketones, halogenerated hydrocarbons and methonal	Nitrile-Butadiene	NBR	N1059	Black	CH ²⁾	90
Ethylene glycol base fluids	-65° to 225°	Phosphate ester base hydraulic fluids, automotive brake fluids, strong acids, ozone, freons, ketones, halogenerated hydrocarbons and methonal	Nitrile-Butadiene	NBR	N0103	Black	—	70
Food product applications (meets FDA requirements)	-35° to 250°	Phosphate ester base hydraulic fluids, automotive brake fluids, strong acids, ozone, freons, ketones, halogenerated hydrocarbons and methonal	Nitrile-Butadiene	NBR	N0508	Black	—	75
Halogenated hydrocarbons	-15° to 400°F	Phosphate ester base hydraulic fluids, automotive brake fluids, strong acids, ozone, freons, ketones, halogenerated hydrocarbons and methonal	Fluorocarbon	FKM ⁵⁾ or FPM	V0747	Black	—	75
Halogenated hydrocarbons	-15° to 400°F	Ketones, skydrol fluids, amines (VDMH), anhydrous ammonia, low molecular weight esters and ethers, hot hydrofluoric or chlorosulfuric acids	Fluorocarbon	FKM ⁵⁾ or FPM	V0884	Brown ¹⁾	—	75
Halogenated hydrocarbons	-15° to 400°F	Ketones, skydrol fluids, amines (VDMH), anhydrous ammonia, low molecular weight esters and ethers, hot hydrofluoric or chlorosulfuric acids	Fluorocarbon	FKM ⁵⁾ or FPM	V0894	Brown ^{1),5)}	HK ⁴⁾	90 ⁶⁾
High aniline point oils	-65° to 450°F	Most petroleum fluids, ketones, water and steam	Silicone	Si	S0604	Rust ¹⁾	—	70
High aniline point petroleum oils	-45° to 250°F	Phosphate ester fluids and ketones	Neoprene	CR	C0873	Black	—	70
High aniline point petroleum oils	-45° to 250°F	Phosphate ester fluids and ketones	Neoprene	CR	C0944	Red ¹⁾	—	70
Hot water	-65° to 275°F	Petroleum based oils and di-ester base lubricants	Ethylene-Propylene	EPDM	E0540	Black	CA ³⁾	80
Hot water	-65° to 275°F	Petroleum based oils and di-ester base lubricants	Ethylene-Propylene	EPDM	E0893	Purple ¹⁾	CA ³⁾	80
Hydrogen Fuel Cells	-65° to 180°F	Phosphate ester base hydraulic fluids, automotive brake fluids, strong acids, ozone, freons, ketones, halogenerated hydrocarbons and methonal	Nitrile-Butadiene	NBR	N0507	Black	—	90
Hydrogen Fuel Cells	-65° to 225°F	Phosphate ester base hydraulic fluids, automotive brake fluids, strong acids, ozone, freons, ketones, halogenerated hydrocarbons and methonal	Nitrile-Butadiene	NBR	N0304	Black	—	75
Ketones	-65° to 275°F	Petroleum based oils and di-ester base lubricants	Ethylene-Propylene	EPDM	E0540	Black	CA ³⁾	80
Ketones	-65° to 275°F	Petroleum based oils and di-ester base lubricants	Ethylene-Propylene	EPDM	E0893	Purple ¹⁾	CA ³⁾	80
Mild Acids	-45° to 250°F	Phosphate ester fluids and ketones	Neoprene	CR	C0873	Black	—	70
Mild Acids	-45° to 250°F	Phosphate ester fluids and ketones	Neoprene	CR	C0944	Red ¹⁾	—	70
Mineral Oils	-30° to 250°	Phosphate ester base hydraulic fluids, automotive brake fluids, strong acids, ozone, freons, ketones, halogenerated hydrocarbons and methonal	Nitrile-Butadiene	NBR	N0674	Black	—	70
Mineral Oils	-30° to 250°F	Phosphate ester base hydraulic fluids, automotive brake fluids, strong acids, ozone, freons, ketones, halogenerated hydrocarbons and methonal	Nitrile-Butadiene	NBR	N0552	Black	CH ²⁾	90 ⁶⁾
Mineral Oils	-30° to 275°F	Phosphate ester base hydraulic fluids, automotive brake fluids, strong acids, ozone, freons, ketones, halogenerated hydrocarbons and methonal	Nitrile-Butadiene	NBR	N1059	Black	CH ²⁾	90
Mineral Oils	-65° to 225°	Phosphate ester base hydraulic fluids, automotive brake fluids, strong acids, ozone, freons, ketones, halogenerated hydrocarbons and methonal	Nitrile-Butadiene	NBR	N0103	Black	—	70
Natural Gas	-30° to 250°	Phosphate ester base hydraulic fluids, automotive brake fluids, strong acids, ozone, freons, ketones, halogenerated hydrocarbons and methonal	Nitrile-Butadiene	NBR	N0674	Black	—	70
Natural Gas	-30° to 250°F	Phosphate ester base hydraulic fluids, automotive brake fluids, strong acids, ozone, freons, ketones, halogenerated hydrocarbons and methonal	Nitrile-Butadiene	NBR	N0552	Black	CH ²⁾	90 ⁶⁾

Dimensions and pressures for reference only, subject to change.





TABLE OF CONTENTS

SECTION TABLE OF CONTENTS

Recommended for	Temperature Range	Not Recommended For	Polymer	Abbreviated Name	Parker Compound	No. Color	SAE J515 Type	Shore Hardness
Natural Gas	-30° to 275°F	Phosphate ester base hydraulic fluids, automotive brake fluids, strong acids, ozone, freons, ketones, halogenated hydrocarbons and methonal	Nitrile-Butadiene	NBR	N1059	Black	CH ²⁾	90
Natural Gas	-65° to 225°	Phosphate ester base hydraulic fluids, automotive brake fluids, strong acids, ozone, freons, ketones, halogenated hydrocarbons and methonal	Nitrile-Butadiene	NBR	N0103	Black	—	70
Petroleum based oils and fluids	-30° to 250°	Phosphate ester base hydraulic fluids, automotive brake fluids, strong acids, ozone, freons, ketones, halogenated hydrocarbons and methonal	Nitrile-Butadiene	NBR	N0674	Black	—	70
Petroleum based oils and fluids	-15° to 400°F	Ketones, skydrol fluids, amines (VDMH), anhydrous ammonia, low molecular weight esters and ethers, hot hydrofluoric or chlorosulfuric acids	Fluorocarbon	FKM ⁵⁾ or FPM	V0747	Black	—	75
Petroleum based oils and fluids	-15° to 400°F	Ketones, skydrol fluids, amines (VDMH), anhydrous ammonia, low molecular weight esters and ethers, hot hydrofluoric or chlorosulfuric acids	Fluorocarbon	FKM ⁵⁾ or FPM	V0884	Brown ¹⁾	—	75
Petroleum based oils and fluids	-15° to 400°F	Ketones, skydrol fluids, amines (VDMH), anhydrous ammonia, low molecular weight esters and ethers, hot hydrofluoric or chlorosulfuric acids	Fluorocarbon	FKM ⁵⁾ or FPM	V0894	Brown ^{1),5)}	HK ⁴⁾	90 ⁶⁾
Petroleum based oils and fluids	-30° to 250°F	Phosphate ester base hydraulic fluids, automotive brake fluids, strong acids, ozone, freons, ketones, halogenated hydrocarbons and methonal	Nitrile-Butadiene	NBR	N0552	Black	CH ²⁾	90 ⁶⁾
Petroleum based oils and fluids	-30° to 275°F	Phosphate ester base hydraulic fluids, automotive brake fluids, strong acids, ozone, freons, ketones, halogenated hydrocarbons and methonal	Nitrile-Butadiene	NBR	N1059	Black	CH ²⁾	90
Petroleum based oils and fluids	-65° to 225°	Phosphate ester base hydraulic fluids, automotive brake fluids, strong acids, ozone, freons, ketones, halogenated hydrocarbons and methonal	Nitrile-Butadiene	NBR	N0103	Black	—	70
Phosphate ester base hydraulic fluids	-65° to 275°F	Petroleum based oils and di-ester base lubricants	Ethylene-Propylene	EPDM	E0540	Black	CA ³⁾	80
Phosphate ester base hydraulic fluids	-65° to 275°F	Petroleum based oils and di-ester base lubricants	Ethylene-Propylene	EPDM	E0893	Purple ¹⁾	CA ³⁾	80
Phosphate ester base hydraulic fluids (some)	-15° to 400°F	Ketones, skydrol fluids, amines (VDMH), anhydrous ammonia, low molecular weight esters and ethers, hot hydrofluoric or chlorosulfuric acids	Fluorocarbon	FKM ⁵⁾ or FPM	V0747	Black	—	75
Phosphate ester base hydraulic fluids (some)	-15° to 400°F	Ketones, skydrol fluids, amines (VDMH), anhydrous ammonia, low molecular weight esters and ethers, hot hydrofluoric or chlorosulfuric acids	Fluorocarbon	FKM ⁵⁾ or FPM	V0884	Brown ¹⁾	—	75
Phosphate ester base hydraulic fluids (some)	-15° to 400°F	Ketones, skydrol fluids, amines (VDMH), anhydrous ammonia, low molecular weight esters and ethers, hot hydrofluoric or chlorosulfuric acids	Fluorocarbon	FKM ⁵⁾ or FPM	V0894	Brown ^{1),5)}	HK ⁴⁾	90 ⁶⁾
Refrigerants (freons, ammonia)	-45° to 250°F	Phosphate ester fluids and ketones	Neoprene	CR	C0873	Black	—	70
Refrigerants (freons, ammonia)	-45° to 250°F	Phosphate ester fluids and ketones	Neoprene	CR	C0944	Red ¹⁾	—	70
Silicate ester lubricants	-45° to 250°F	Phosphate ester fluids and ketones	Neoprene	CR	C0873	Black	—	70
Silicate ester lubricants	-45° to 250°F	Phosphate ester fluids and ketones	Neoprene	CR	C0944	Red ¹⁾	—	70
Silicone and di-ester base lubricants	-30° to 250°	Phosphate ester base hydraulic fluids, automotive brake fluids, strong acids, ozone, freons, ketones, halogenated hydrocarbons and methonal	Nitrile-Butadiene	NBR	N0674	Black	—	70
Silicone and di-ester base lubricants	-30° to 250°F	Phosphate ester base hydraulic fluids, automotive brake fluids, strong acids, ozone, freons, ketones, halogenated hydrocarbons and methonal	Nitrile-Butadiene	NBR	N0552	Black	CH ²⁾	90 ⁶⁾
Silicone and di-ester base lubricants	-30° to 275°F	Phosphate ester base hydraulic fluids, automotive brake fluids, strong acids, ozone, freons, ketones, halogenated hydrocarbons and methonal	Nitrile-Butadiene	NBR	N1059	Black	CH ²⁾	90
Silicone and di-ester base lubricants	-65° to 225°	Phosphate ester base hydraulic fluids, automotive brake fluids, strong acids, ozone, freons, ketones, halogenated hydrocarbons and methonal	Nitrile-Butadiene	NBR	N0103	Black	—	70

Dimensions and pressures for reference only, subject to change.





TABLE OF CONTENTS

SECTION TABLE OF CONTENTS

Recommended for	Temperature Range	Not Recommended For	Polymer	Abbreviated Name	Parker Compound	No. Color	SAE J515 Type	Shore Hardness
Silicone and silicate ester based lubricants	-15° to 400°F	Ketones, skydrol fluids, amines (VDMH), anhydrous ammonia, low molecular weight esters and ethers, hot hydrofluoric or chlorosulfuric acids	Fluorocarbon	FKM ⁵⁾ or FPM	V0747	Black	—	75
Silicone and silicate ester based lubricants	-15° to 400°F	Ketones, skydrol fluids, amines (VDMH), anhydrous ammonia, low molecular weight esters and ethers, hot hydrofluoric or chlorosulfuric acids	Fluorocarbon	FKM ⁵⁾ or FPM	V0884	Brown ¹⁾	—	75
Silicone and silicate ester based lubricants	-15° to 400°F	Ketones, skydrol fluids, amines (VDMH), anhydrous ammonia, low molecular weight esters and ethers, hot hydrofluoric or chlorosulfuric acids	Fluorocarbon	FKM ⁵⁾ or FPM	V0894	Brown ^{1),5)}	HK ⁴⁾	90 ⁶⁾
Silicone oils and greases	-65° to 275°F	Petroleum based oils and di-ester base lubricants	Ethylene-Propylene	EPDM	E0540	Black	CA ³⁾	80
Silicone oils and greases	-65° to 275°F	Petroleum based oils and di-ester base lubricants	Ethylene-Propylene	EPDM	E0893	Purple ¹⁾	CA ³⁾	80
Steam to 400°F	-65° to 275°F	Petroleum based oils and di-ester base lubricants	Ethylene-Propylene	EPDM	E0540	Black	CA ³⁾	80
Steam to 400°F	-65° to 275°F	Petroleum based oils and di-ester base lubricants	Ethylene-Propylene	EPDM	E0893	Purple ¹⁾	CA ³⁾	80
Water under 150°F	-30° to 250°	Phosphate ester base hydraulic fluids, automotive brake fluids, strong acids, ozone, freons, ketones, halogenated hydrocarbons and methonal	Nitrile-Butadiene	NBR	N0674	Black	—	70
Water under 150°F	-30° to 250°F	Phosphate ester base hydraulic fluids, automotive brake fluids, strong acids, ozone, freons, ketones, halogenated hydrocarbons and methonal	Nitrile-Butadiene	NBR	N0552	Black	CH ²⁾	90 ⁶⁾
Water under 150°F	-30° to 275°F	Phosphate ester base hydraulic fluids, automotive brake fluids, strong acids, ozone, freons, ketones, halogenated hydrocarbons and methonal	Nitrile-Butadiene	NBR	N1059	Black	CH ²⁾	90
Water under 150°F	-65° to 225°	Phosphate ester base hydraulic fluids, automotive brake fluids, strong acids, ozone, freons, ketones, halogenated hydrocarbons and methonal	Nitrile-Butadiene	NBR	N0103	Black	—	70

Table T15 – O-Ring Selection

- 1) These Parker “Chromasure” color assurance O-Rings are available from the Parker Hannifin O-Ring Division. They help eliminate assembly errors, reduce warranty costs and liability risks, and assure safety in aftermarket business.
- 2) Formerly SAE Type I.
- 3) Formerly SAE Type II.
- 4) Formerly SAE Type III.
- 5) “FKM” is the ASTM designation for fluorocarbon. Its ISO designation is “FPM”. For “DIN” Fittings, color is green.
- 6) Standard compounds available from stock.
- 7) Use 90 durometer hard O-Rings for applications with 1500 psi or higher pressures.

Dimensions and pressures for reference only, subject to change.



Tube and Fitting Material Compatibility.....

As a general rule, tube and fitting materials should be the same. If different materials must be considered, the following chart can be used as a general guide. Since operating conditions differ with applications, this chart should be used only as a guide and not a firm recommendation.

Before making a final decision on material combination, it should be sufficiently tested under appropriate conditions to assure suitability for the intended application. For additional material combinations, contact the Tube Fittings Division.

TABLE OF CONTENTS

SECTION TABLE OF CONTENTS

Tube Material	Specification	Construction	Condition	Max. Hardness	Temperature Range (7)	Application	Tube Material to Fitting & Material Compatibility																
							Seal-Lok ORFS (SAE J1453)			Triple-Lok 37° Flare (SAE J514)			Ferulok Flareless (SAE J514)			Intru-Lok Flareless	EO/EO-2 Flareless (ISO 8434-1)						
							S	SS	B	S	SS	B	M	S	SS	M	B	S, SS, B					
Carbon Steel C-1010	SAE J524 (ASTM A179) (8)	Seamless	Fully Annealed	HRB 72	-65° to 500°F -55° to 260°C	High pressure hydraulic, air, & some specialty chemicals	E	NR	(6)	G	NR	(6)	NR	E	NR	NR	NR	NR	NR				
	SAE J525 (ASTM A178) (8)	Welded & Drawn					E	NR	(6)	E	NR	(6)	NR	E	NR	NR	NR	NR	NR				
	SAE J356	Welded & Flash Controlled					G	NR	(6)	NR	NR	(6)	NR	G	NR	NR	NR	NR	NR				
Carbon Steel C-1021	SAE J2467	Welded & Flash Controlled	Fully Annealed	HRB 75	-65° to 500°F -55° to 260°C	High pressure hydraulic	E	NR	(6)	NR	NR	(6)	NR	E	NR	NR	NR	NR					
	SAE J2435	Welded & Drawn					E	NR	(6)	E	NR	(6)	NR	E	NR	NR	NR	NR	NR				
Carbon Steel High Strength Low Alloy (HSLA)	SAE 2613	Welded & Flash Controlled	Sub-critically annealed	HRB 90	-65° to 500°F -55° to 260°C	High pressure hydraulic	E	NR	(6)	NR	NR	(6)	NR	NR	NR	NR	NR	NR					
	SAE J2614	Welded & Drawn					E	NR	(6)	NR	NR	(6)	NR	NR	NR	NR	NR	NR	NR				
Alloy Steel 4130	ASTM A519	Seamless			-65° to 500°F -55° to 260°C	High pressure hydraulics	E	NR	NR	NR	NR	NR	NR	NR	NR	NR	NR	NR					
St 37.4 (Carbon Steel)	DIN 2391 Part 2 (Metric)	Seamless	Fully Annealed	HRB 72	-65° to 500°F -55° to 260°C	High pressure hydraulic, air, & some specialty chemicals	E	NR	NR	G	NR	NR	NR	NR	NR	NR	NR	E					
Stainless Steel 304 & 316	ASTM A213 ASTM A269	Seamless	Fully Annealed	HRB 90	-425° to 1200° -255° to 650°C (3)	High pressure, high temperature, or generally corrosive media (1)	(6)	E	(6)	(6)	G	(6)	NR	(6)	E	NR	NR	E					
	ASTM A249 ASTM A269	Welded & Drawn					(6)	E	(6)	(6)	E	(6)	NR	(6)	E	NR	NR	NR	E				
1.4571 1.4541 Stainless Steel	DIN 17458 Tab 8 (Metric)	Seamless	Fully Annealed	HRB 90	-425° to 1200° -255° to 650°C (3)	High pressure, high temperature, or generally corrosive media (1)	(6)	E	NR	(6)	G	NR	NR	NR	E	NR	NR	E					
Copper	SAE J528 (ASTM B-75) (8)	Seamless	Soft Annealed Temper 0	60 Max. Rockwell 15T	-325° to 400°F -200° to 205°C	Low pressure, low temperature, water, oil & air	E	(6)	E	G	(6)	E	NR	G	(2)	NR	NR	E					
Aluminum 6061	ASTM-B210	Seamless	T6 Temper	HRB 56	-325° to 400°F -200° to 205°C	Low pressure, low temperature, water, oil, air & some specialty chemicals	NR	NR	NR	G	NR	NR	NR	E	(2)	NR	NR	(6)	NR				
			0 & T4 Temper	HRB 30			E	(5)	NR	NR	G	NR	NR	NR	E	(2)	NR	NR	(6)	NR			
Monel 400	ASTM-B165	Seamless	Fully Annealed	HRB 70	-400° to 800°F -240° to 425°C	Sour gas, marine & general chemical processing media	NR	(6)	NR	NR	(6)	NR	E	NR	(6)	E	NR	NR					
Nylon		Extruded	Flexible & Semi-Rigid		-60° to 200°F -50° to 95°C	Lube lines, chemical process controls & air	NR	NR	NR	NR	NR	NR	NR	G	(2)	G	(2)	G	(2)	E	G	(2), (9)	
Polyethylene	ASTM D-1248	Extruded	Instrument Grade		-80° to 150°F -60° to 65°C	Instrumentation lines	NR	NR	NR	NR	NR	NR	NR	G	(2)	G	(2)	G	(2)	E	G	(2), (9)	
PVC		Extruded	Instrument & Laboratory Grade		0° to 140°F -20° to 60°C	General purpose laboratory use	NR	NR	NR	NR	NR	NR	NR	NR	NR	NR	NR	NR	G	NR	NR		
PTFE		Extruded & Cintered			-65° to 400°F -55° to 205°C	Very low pressure, high temperature, fuel, lube, chemical & air applications	NR	NR	NR	NR	NR	NR	NR	G	(2)	G	(2)	G	(2)	G	NR	G	(2), (9)

Table T16 – Tube and Fitting Material Compatibility

Ratings Key:
NR Not Recommended
F Fair
G Good
E Excellent

Fitting Materials Code:
S Steel
SS Stainless Steel
B Brass
M Monel

Notes:

- 1) For highly corrosive media or service environment, contact the Tube Fittings Division.
- 2) Requires different assembly procedure. Contact the Tube Fittings Division.
- 3) Low temperature limit for stainless steel Ferulok fittings is -20°F (-30°C).
- 4) For brazing only. Grade 4130 not recommended with Parflange process.
- 5) For use with Parflange process only. Not recommended with brazing.
- 6) Use depends on specific application. Contact the Tube Fittings Division.
- 7) Applies to tube material.
- 8) Comparable specifications to SAE.
- 9) With metric version of tubing.
- 10) Not tested with Parflange. Contact the Tube Fittings Division.

Dimensions and pressures for reference only, subject to change.



T

Pressure



TABLE OF CONTENTS

SECTION TABLE OF CONTENTS

Fitting and Adapter Pressure Ratings

Fitting Pressure Ratings

Pressure ratings shown on the product pages of this catalog are for dynamic systems. A vast majority of systems where our fittings are used fall in this category. However, there are applications, such as hydraulic jacks, where the system pressure is essentially static once it is pressurized. For this type of an application the fittings can be used at higher pressures.

The dynamic and static systems can be defined as follows:

Dynamic: A system in which the operating pressure fluctuates, in accordance with load, up to a maximum pressure limited by the relief valve. In addition, the system may also experience shocks, vibration and temperature excursions. Example: A backhoe.

Static: A system, once pressurized, is essentially free of pressure fluctuations, shock, vibration and temperature excursions, with such pressurizations not exceeding 30,000 in the life of the system. Example: A hydraulic jack.

The dynamic pressure ratings are based on a minimum design factor of 4. In other words, the fitting is capable of holding a pressure equal to 4 times the rated pressure before leakage or failure. For static applications, the design factor can be 3. Hence, the static rating can be determined by multiplying the dynamic rating by 1.33.

Static pressure rating = 1.33 x Dynamic pressure rating

Example: Static pressure rating for a fitting rated at 6000 psi = 1.33 x 6000 = 8000 psi

Higher (dynamic) Ratings

Some parts are capable of performing at higher pressures than those shown on the product pages. For information on higher ratings, contact Tube Fittings Division.

Tubing Pressure Ratings

Using Tables T20 and T21, determine the tube O.D. and wall thickness combination that satisfies the following two conditions:

- Has recommended design pressure equal to or higher than maximum operating pressure.
- Provides tube I.D. equal to or greater than required flow diameter determined earlier.

Design pressure values in Tables T20 and T21 are based on the severity of service rating "A" (design factor of 4) in Table T19, and temperature derating factor of 1 in Table T7 on page T9.

If more severe operating conditions are involved, the values in Tables T20 and T21 should be multiplied by appropriate derating factors from Tables T19 and T7 before determining the tube O.D. and wall thickness combination. Contact the Tube Fittings Division when in doubt.

Material and Type	Allowable Design Stress for Factor of 4 at 72°F	Tube Specification
Steel C1010	11,250 PSI	SAE J356, J524, J525
Steel C1021	15,000 PSI	SAE J2435, L2467
Steel, High Strength Low Alloy (HSLA)	18,000 PSI	SAE J2613, J2614
Stainless Steel 304 & 316	18,800 PSI	ASTM A213, A249, A269
Alloy Steel C4130	18,800 PSI	ASTM A519
Copper, K or Y	6,000 PSI	SAE J528, ASTM B75
Aluminum 6061-T6	10,500 PSI	ASTM B210
Monel, 400	17,500 PSI	ASTM B165

Table T17 – Design Stress Values

Design Pressure Formula (LAME'S)

$$P = S \left(\frac{D^2 - d^2}{D^2 + d^2} \right) \text{ where:}$$

D = Outside diameter of tube, in.
d = Inside diameter of tube (D-2T), in.
P = Recommended design pressure, psi
S = Allowable stress for design factor of 4, psi
T = Tube wall thickness, in.

Table T18 – Design Pressure Formula

*For thin wall tubes (D/T ≥ 10) the following formula may be Used: **P = 2ST/D**

Severity of Service	Description	Design Factor	Derating Factor
A (Normal)	Moderate mechanical and hydraulic shocks.	4.00	1.00
B (Severe)	Severe hydraulic shocks and mechanical strain.	6.00	0.67
C (Hazardous)	Hazardous application with severe service conditions.	8.00	0.50

Table T19 – Severity of Service Design and Derating Factors

Allowable design stress levels and formula used to arrive at the design pressure values are given in the following chart. Values in Table T7 are for fully annealed tubing.

The design factor is generally applied to ultimate strength of material (or burst pressure of tubing) to provide a measure of design margin against the unknowns in material and operating conditions. The derating factors listed here should be applied directly to the design pressure values in Tables T20 and T21 to arrive at maximum recommended working pressures (i.e., multiply values in Tables T20 and T21 by these derating factors).

Inch Tube Pressure Ratings



TABLE OF CONTENTS
SECTION TABLE OF CONTENTS

Inch Tubes*							Inch Tubes*						
Tube O.D. (in.)	Wall Thick. (in.)	Tube I.D. (in.)	Design Pressure				Tube O.D. (in.)	Wall Thick. (in.)	Tube I.D. (in.)	Design Pressure			
			Steel C-1010	Steel C-1021	Stainless Steel 304 & 316, 4130 HSLA	Copper K or Y				Steel C-1010	Steel C-1021	Stainless Steel 304 & 316, 4130 HSLA	Copper K or Y
0.125	0.010	0.105	1,900	2,550	3,200	1,000	0.625	0.058	0.509	2,250	3,000	3,750	1,200
0.125	0.020	0.085	4,100	5,500	6,850	2,200	0.625	0.065	0.495	2,550	3,400	4,250	1,350
0.125	0.028	0.069	5,950	7,950	9,950	3,150	0.625	0.083	0.459	3,350	4,450	5,600	1,750
0.125	0.035	0.055	7,550	10,100	12,650	4,050	0.625	0.095	0.435	3,900	5,200	6,500	2,050
0.188	0.010	0.168	1,250	1,650	2,100	650	0.625	0.109	0.407	4,500	6,050	7,550	2,400
0.188	0.020	0.148	2,600	3,500	4,400	1,400	0.625	0.120	0.385	5,050	6,700	8,400	2,700
0.188	0.028	0.132	3,800	5,050	6,350	2,000	0.625	0.134	0.357	5,700	7,600	9,500	3,000
0.188	0.035	0.118	4,850	6,500	8,150	2,600	0.750	0.035	0.680	1,050	1,450	1,800	550
0.188	0.049	0.090	7,000	9,400	11,750	3,750	0.750	0.049	0.652	1,550	2,050	2,600	800
0.250	0.020	0.210	1,900	2,550	3,200	1,000	0.750	0.058	0.634	1,850	2,450	3,100	1,000
0.250	0.028	0.194	2,750	3,700	4,650	1,450	0.750	0.065	0.620	2,100	2,800	3,500	1,100
0.250	0.035	0.180	3,350	4,750	5,900	1,900	0.750	0.083	0.584	2,750	3,650	4,550	1,450
0.250	0.049	0.152	5,150	6,900	8,600	2,750	0.750	0.095	0.560	3,150	4,250	5,300	1,700
0.250	0.058	0.134	6,200	8,300	10,350	3,300	0.750	0.109	0.532	3,700	4,950	6,150	1,950
0.250	0.065	0.120	7,000	9,350	11,700	3,750	0.750	0.120	0.510	4,100	5,500	6,850	2,200
0.250	0.083	0.084	8,950	11,950	14,900	4,750	0.750	0.134	0.482	4,650	6,200	7,750	2,450
0.313	0.020	0.273	1,500	2,000	2,500	800	0.750	0.148	0.454	5,200	6,950	8,650	2,750
0.313	0.028	0.257	2,150	2,900	3,600	1,150	0.750	0.188	0.374	6,750	9,000	11,250	3,600
0.313	0.035	0.243	2,750	3,700	4,600	1,450	0.875	0.035	0.805	900	1,200	1,550	500
0.313	0.049	0.215	4,000	5,350	6,700	2,150	0.875	0.049	0.777	1,300	1,750	2,200	700
0.313	0.058	0.197	4,850	6,450	8,100	2,550	0.875	0.058	0.759	1,550	2,100	2,600	800
0.313	0.065	0.183	5,500	7,350	9,150	2,900	0.875	0.065	0.745	1,750	2,350	2,950	950
0.313	0.083	0.147	7,150	9,550	11,950	3,800	0.875	0.083	0.709	2,300	3,100	3,850	1,200
0.313	0.095	0.123	8,200	10,950	13,700	4,350	0.875	0.095	0.685	2,650	3,600	4,500	1,400
0.375	0.020	0.335	1,250	1,650	2,100	650	0.875	0.109	0.657	3,100	4,150	5,200	1,650
0.375	0.028	0.319	1,800	2,400	3,000	950	0.875	0.120	0.635	3,450	4,650	5,800	1,850
0.375	0.035	0.305	2,250	3,050	3,800	1,200	0.875	0.134	0.607	3,900	5,250	6,550	2,100
0.375	0.049	0.277	3,300	4,400	5,500	1,750	0.875	0.148	0.579	4,350	5,850	7,300	2,300
0.375	0.058	0.259	3,950	5,300	6,600	2,100	1.000	0.035	0.930	800	1,050	1,350	400
0.375	0.065	0.245	4,500	6,000	7,500	2,400	1.000	0.049	0.902	1,150	1,500	1,900	600
0.375	0.083	0.209	5,900	7,850	9,850	3,150	1.000	0.058	0.884	1,350	1,800	2,300	700
0.375	0.095	0.185	6,800	9,100	11,400	3,650	1.000	0.065	0.870	1,550	2,050	2,550	800
0.375	0.109	0.157	7,850	10,500	13,150	4,200	1.000	0.083	0.834	2,000	2,650	3,350	1,050
0.500	0.028	0.444	1,300	1,750	2,200	700	1.000	0.095	0.810	2,300	3,100	3,850	1,200
0.500	0.035	0.430	1,650	2,200	2,800	850	1.000	0.109	0.782	2,700	3,600	4,500	1,400
0.500	0.049	0.402	2,400	3,200	4,000	1,250	1.000	0.120	0.760	3,000	4,000	5,000	1,600
0.500	0.058	0.384	2,900	3,850	4,800	1,500	1.000	0.134	0.732	3,350	4,500	5,650	1,800
0.500	0.065	0.370	3,250	4,350	5,450	1,750	1.000	0.148	0.704	3,750	5,050	6,300	2,000
0.500	0.083	0.334	4,300	5,700	7,150	2,250	1.000	0.156	0.688	4,000	5,350	6,700	2,100
0.500	0.095	0.310	4,950	6,650	8,300	2,650	1.000	0.188	0.624	4,900	6,550	8,200	2,600
0.500	0.109	0.282	5,800	7,750	9,700	3,100	1.000	0.220	0.560	5,850	7,800	9,750	3,100
0.500	0.120	0.260	6,450	8,600	10,750	3,400	1.250	0.049	1.152	900	1,200	1,500	450
0.500	0.134	0.232	7,250	9,650	12,100	3,850	1.250	0.058	1.134	1,050	1,450	1,800	550
0.500	0.148	0.204	8,000	10,700	13,350	4,250	1.250	0.065	1.120	1,200	1,600	2,050	650
0.500	0.188	0.124	9,900	13,250	16,550	5,300	1.250	0.083	1.084	1,550	2,100	2,650	800
0.625	0.028	0.569	1,050	1,400	1,750	550	1.250	0.095	1.060	1,800	2,450	3,050	950
0.625	0.035	0.555	1,300	1,750	2,200	700	1.250	0.109	1.032	2,100	2,800	3,550	1,100
0.625	0.049	0.527	1,900	2,500	3,150	1,000	1.250	0.120	1.010	2,350	3,150	3,900	1,250

Table T20 – Inch Tube Pressure Ratings
*See Table T16 for tube specifications.

Dimensions and pressures for reference only, subject to change.



Inch Tube Pressure Ratings (cont'd.) **P**

TABLE OF CONTENTS

SECTION TABLE OF CONTENTS

Inch Tubes*						
Tube O.D. (in.)	Wall Thick. (in.)	Tube I.D. (in.)	Design Pressure			
			Pressure C-1010	Steel C-1021	Stainless Steel 304 & 316, 4130 HSLA	Copper K or Y
1.250	0.134	0.982	2,650	3,550	4,400	1,400
1.250	0.148	0.954	2,950	3,950	4,900	1,550
1.250	0.156	0.938	3,100	4,150	5,200	1,650
1.250	0.188	0.874	3,850	5,100	6,400	2,050
1.250	0.220	0.810	4,550	6,100	7,650	2,450
1.500	0.065	1.370	1,000	1,350	1,650	500
1.500	0.083	1.334	1,300	1,750	2,150	700
1.500	0.095	1.310	1,500	2,000	2,500	800
1.500	0.109	1.282	1,750	2,300	2,900	900
1.500	0.120	1.260	1,900	2,550	3,200	1,000
1.500	0.134	1.232	2,150	2,900	3,600	1,150
1.500	0.148	1.204	2,400	3,200	4,050	1,250
1.500	0.156	1.188	2,550	3,400	4,250	1,350
1.500	0.188	1.124	3,150	4,200	5,250	1,650
1.500	0.220	1.060	3,750	5,000	6,250	2,000
1.500	0.250	1.000	4,300	5,750	7,200	2,300
2.000	0.065	1.870	750	1,000	1,250	400
2.000	0.083	1.834	950	1,250	1,600	500
2.000	0.095	1.810	1,100	1,450	1,850	550
2.000	0.109	1.782	1,250	1,700	2,150	650
2.000	0.120	1.760	1,400	1,900	2,350	750
2.000	0.134	1.732	1,600	2,100	2,650	850
2.000	0.148	1.704	1,750	2,350	2,950	950
2.000	0.156	1.688	1,850	2,500	3,150	1,000
2.000	0.188	1.624	2,300	3,050	3,800	1,200
2.000	0.220	1.560	2,700	3,650	4,550	1,450
2.000	0.250	1.500	3,100	4,200	5,250	1,650
2.000	0.281	1.438	3,550	4,750	5,950	1,900

Table T20 – Inch Tube Pressure Ratings (cont'd.)

*See Table T16 for tube specifications.

Dimensions and pressures for reference only, subject to change.



Metric Tube Pressure Ratings.....



TABLE OF CONTENTS

SECTION TABLE OF CONTENTS

Metric Tubes				
Tube O.D. (mm.)	Wall Thick. (mm.)	Tube I.D. (mm.)	Static Design Pressure (Bar)	
			Steel Low-Carbon St. 37-4	Stainless Steel 1.4571
4	0.5	3.0	313	
4	0.75	2.5	409	
4	1.0	2.0	522	600
5	1.0	3.0	432	
6	0.75	4.5	333	
6	1.0	4.0	389	426
6	1.5	3.0	549	600
6	2.0	2.0	692	
6	2.25	1.5	757	
8	1.0	6.0	333	368
8	1.5	5.0	431	472
8	2.0	4.0	549	
8	2.5	3.0	658	
10	1.0	8.0	282	294
10	1.5	7.0	373	389
10	2.0	6.0	478	498
10	2.5	5.0	576	
10	3.0	4.0	666	
12	1.0	10.0	235	245
12	1.5	9.0	353	368
12	2.0	8.0	409	426
12	2.5	7.0	495	
12	3.0	6.0	576	
12	3.5	5.0	651	
14	1.5	11.0	302	315
14	2.0	10.0	357	420
14	2.5	9.0	434	452
14	3.0	8.0	507	
14	3.5	7.0	576	
14	4.0	6.0	641	
15	1.0	13.0	188	196
15	1.5	12.0	282	294
15	2.0	11.0	336	392
15	3.0	9.0	478	
16	1.5	13.0	264	276
16	2.0	12.0	353	368
16	2.5	11.0	386	403
16	3.0	10.0	452	472
18	1.0	16.0	157	
18	1.5	15.0	235	245
18	2.0	14.0	313	327
18	2.5	13.0	392	
18	3.0	12.0	409	
20	1.5	17.0	212	
20	2.0	16.0	282	294
20	2.5	15.0	353	368
20	3.0	14.0	373	389
20	3.5	13.0	426	
20	4.0	12.0	478	
22	1.5	19.0	192	200
22	2.0	18.0	256	267
22	2.5	17.0	320	
22	3.0	16.0	343	
25	2.0	21.0	226	
25	2.5	20.0	282	294
25	3.0	19.0	338	353

Metric Tubes				
Tube O.D. (mm.)	Wall Thick. (mm.)	Tube I.D. (mm.)	Static Design Pressure (Bar)	
			Steel Low-Carbon St. 37-4	Stainless Steel 1.4571
25	4.0	17.0	394	
25	4.5	16.0	437	
25	5.0	15.0	478	
28	1.5	25.0	151	158
28	2.0	24.0	201	210
28	2.5	23.0	252	
28	3.0	22.0	302	
30	2.0	26.0	188	
30	2.5	25.0	235	245
30	3.0	24.0	282	294
30	4.0	22.0	336	392
30	5.0	20.0	409	
35	2.0	31.0	161	168
35	2.5	30.0	201	
35	3.0	29.0	242	
35	4.0	27.0	322	
38	2.5	33.0	186	
38	3.0	32.0	223	
38	4.0	30.0	297	309
38	5.0	28.0	332	
38	6.0	26.0	390	
38	7.0	24.0	446	
42	2.0	38.0	134	140
42	3.0	36.0	201	210
42	4.0	34.0	269	
50	6.0	38.0	338	
50	9.0	32.0	437	
65	8.0	49.0	347	

Table T21 – Metric Tube Pressure Ratings

Dimensions and pressures for reference only, subject to change.





Tube Selection Example

To select tube material and tube sizes for pressure, return and suction lines for a hydraulic power unit with the following operating parameters known:

Type of fluid: Petroleum base hydraulic fluid

Operating temperature range: -20°F to +140°F.

Maximum operating pressure: 3500 psi

Maximum flow rate through each line: 10 GPM

Severity of service: A (normal)

1. Selecting Tube Material: Table T6 indicates that carbon steel, C-1010, tubing would meet the media, operating temperature range, and maximum operating pressure (high) requirements.

2. Sizing the Tube: From Table T1, the recommended flow diameters for various lines for 10 GPM flow rate are: 0.405 for pressure line, 0.639 for return line, and 1.012 for suction line.

Now, using Tables T20 and T21, we need to find tubes with inside diameters (I.D.) equal to or larger than the above flow diameters, and wall thicknesses appropriate for design pressures of 3500 psi minimum for the pressure line and about 500 psi for return and suction lines. Since derating factors for Severity of Service (Table T19) and Max. Operating Temperature (Table T7) are both 1, design pressure values in Tables T20 and T21 do not need to be reduced. Matching tube I.D.s and design pressures in Tables T15 and T16 for above conditions, we find:

- A) For the pressure line, we would choose 5/8" O.D. x .083" wall tubing. The .095" and .109" wall tubes would also be satisfactory if .083" wall is not readily available.
- B) For the return line, either 3/4" x .035" or 3/4" x .049" would meet the requirements. If Ferulok fittings are being used, we will need to go to 3/4" x .065" because .065" is the smallest wall thickness recommended for 3/4" O.D. tubing used with Ferulok fittings in Table T22. This reduces the flow diameter about 3% below the recommended value, but is still in the acceptable range. The alternative is to go to 7/8" O.D. x .072" wall tubing, which is way too large.
- C) For the suction line, we can use any one of the following tubes: 1-1/4" O.D. x .049" to .083" wall tube for Triple-Lok or Seal-Lok fittings and 1-1/4" O.D. x .095" wall tube for Ferulok fittings.

One final consideration in choosing the right wall thickness for tubing is bending. If bending without the use of a mandrel is desired, then wall thickness of less than 7% of tube O.D. should not be used.

Tube Material			Steel St. Steel Copper Aluminum	Steel St. Steel Monel	Steel Alloy Steel St. Steel Copper Monel	Copper Aluminum Plastics	Steel St. Steel
Size			SAE 37° Flare Triple-Lok	SAE Flareless Ferulok	SAE O-Ring Face Seal Seal-Lok	Intru-Lok	Metric Flareless
O.D. (in.)	O.D. (mm)	Dash #					
1/8	4	-2	.010 - .035	.010 - .035	—	.012 - .028	0.5 - 1
3/16	6	-3	.010 - .035	.020 - .049	—	.012 - .035	1 - 2
1/4	8	-4	.020 - .065	.028 - .065	.020 - .083	.020 - .049	1 - 2.5
5/16	10	-5	.020 - .065	.028 - .065	.020 - .095	.020 - .065	1 - 3
3/8	12	-6	.020 - .065	.035 - .095	.020 - .109	.028 - .065	1.5 - 3.5
1/2	14	-8	.028 - .083	.049 - .120	.028 - .148	.035 - .083	1.5 - 4
5/8	15	-10	.035 - .095	.058 - .120	.035 - .134	.035 - .083	1.5 - 4
3/4	16	-12	.035 - .109	.065 - .120	.035 - .148	.035 - .095	2 - 4
7/8	18	-14	.035 - .109	.072 - .120	—	.049 - .095	2 - 4
1	20	-16	.035 - .120	.083 - .148	.035 - .188	.049 - .120	2.5 - 4
1 1/4	22	-20	.049 - .120	.095 - .188	.049 - .220		2.5 - 4
1 1/2	25	-24	.049 - .120	.095 - .220	.049 - .250		2.5 - 4.5
2	28	-32	.058 - .134	.095 - .220	.065 - .220		2.5 - 4.5
	30						2.5 - 5
	35						3 - 5
	38						3 - 6
	42						3.5 - 7

1) Brazing to attach sleeve can be used for all wall thicknesses. For flanging tool availability, see page R24.

Table T22 – Recommended “Min./Max” Tube Wall Thickness for Common Fittings

How to Order Seal-Lok, Triple-Lok, Ferulok, Intru-Lok, JIS and K4

TFD Standard Nomenclature Construction

Box 1	Box 2	Box 3	Box 4	Box 5	Box 6
Size	Shape or Style	Sub-Style	Type	Material	Plating Options
1 to 4 sets of numbers from Box 1	Letter code from Box 2	Number/Letter code from Box 3	Number/Letter code from Box 4	Letter code from Box 5	Letter code from Box 6

Example: Steel Seal-Lok Adjustable Elbow Connector — 3/8" O.D. (-6) Tube to 7/16-20 UNF (-4) ORB = 6-4 C5L-S

(See the shading in the boxes below for the construction of this example)

Tube End		Port End		Port End	
Dash Size	Tube O.D.	Dash Size	SAE Straight Thread	Dash Size	NPTF Pipe Thread
-2	1/8	-2	5/16-24	-2	1/8
-3	3/16	-3	3/8-24	-2	1/8
-4	1/4	-4	7/16-20	-2	1/8
-5	5/16	-5	1/2-20	-2	1/8
-6	3/8	-6	9/16-18	-4	1/4
-8	1/2	-8	3/4-16	-6	3/8
-10	5/8	-10	7/8-14	-8	1/2
-12	3/4	-12	1 1/16-12	-12	3/4
-14	7/8	-14	1 3/16-12	-12	3/4
-16	1	-16	1 5/16-12	-16	1
-20	1 1/4	-20	1 5/8-12	-20	1 1/4
-24	1 1/2	-24	1 7/8-12	-24	1 1/2
-32	2	-32	2 1/2-12	-32	2

Straights		90° Elbows	
B	Nut	C*	Male Elbow Connector
F*	Male Connector	CC*	Long Male Elbow
FF*	Long Male Connector or Pipe Nipple	CCC*	Extra Long Male Elbow
FFF*	Extra Long Male Connector or Pipe Nipple	D	Female Elbow
FN	Cap	E	Union Elbow
G*	Female Connector	WE	Bulkhead Union Elbow
H	Union	45° Elbows	
HH	Long Union	N	Union Elbow
HPN*	Plug, Straight Thread, Hollow Hex	V*	Male Elbow Connector
LH	Large Hex Union	WN	Bulkhead Union Elbow
PN*	Plug, Straight Thread, Hex Head	Tees	
T	Sleeve or Ferrule	J	Union Tee
TP	Sleeve, Parflange	M	Female Run Tee
TR	Tube Reducer	O	Female Branch Tee
T22	Mountie	R*	Male Run Tee
W	Bulkhead Union	S*	Male Branch Tee
WF	Bulkhead Male	WJ	Bulkhead Branch Tee
WG	Bulkhead Female	WJJ	Bulkhead Run Tee
WLN	Bulkhead Locknut for Triple-Lok, Ferulok, and Intru-Lok	Cross	
WLNL	Bulkhead Locknut for Seal-Lok	K	Union Cross

Connectors (a)	
3	BSPT Port End
4**	BSPP Port End, O-Ring & RR
5**	SAE Straight Thread Port End
8**	Metric Port End, O-Ring & RR
9	SAE-ORB with Metal Seal
42	BSPP Port End, "ED" Seal
47**	BSPP O-Ring Port, B2351
82	Metric Port End, "ED" Seal
87**	ISO 6149 Port End
J4 (e)	Banjo Connection, BSPP, Soft Seal
J8 (e)	Banjo Connection, Metric, Soft Seal
Swivel Unions (b)	
6	Female Swivel
Swivel Connectors (c)	
63	BSPT Port, Swivel Connector
64**	BSPP Port, Swivel Connector
642	BSPP, "ED" Seal, Swivel Connector
65**	SAE-ORB, Swivel Connector
68**	Metric Port, Swivel Connector
682	Metric Port, Swivel Connector
687**	ISO 6149, Swivel Connector
Straight Thread Plugs (d) (Modifiers for P)	
4, 5, 8, 9 and 87 as in Connectors above.	
Notes	
a. Modifiers for Connectors as noted with asterisk in Box 2.	
b. Modifier for C, V, R, S, H, E and J in Box 2.	
c. Modifiers for F only in Box 2.	
d. Modifiers for P only in PN and HPN in Box 2.	
e. Applies to 90° elbows and tees only.	

I	Intru-Lok
K4	60° Cone BSPP
L**	Seal-Lok
P4	JIS 60° Cone
T4	JIS 30° Flare
U	Ferulok
X	Triple-Lok

B	Brass
CUNI	Cupro-Nickel (ex. CUNI 70/30)
D	Dural (Aluminum)
M	Monel
S	Steel w/ zinc plating
SS	Stainless Steel. 316/316L passivated

ZJ	Parker XTR Plating
----	--------------------

**Placing the letter "O" after these sub-style modifiers and fitting types will indicate that you would like an O-Ring on that corresponding end.

Dimensions and pressures for reference only, subject to change.



How to Order 4-Bolt Hydraulic Flanges

TFD Standard Nomenclature Construction

Box 1	Box 2	Box 3	Box 4	Box 5	Box 6	Box 7
Flange Size	Connection Description	Shape	Flange Connection Type	Mounting Style	Material	Kit Designation

TABLE OF CONTENTS

SECTION TABLE OF CONTENTS

Box 1 – Port/Tube/Pipe Flange Size

Symbol	Description
One-to-two digit codes	Size in inches x 16

One code is required if end connections are the same size. Two codes are required if they are different sizes (e.g., 16-12).

Box 2 – Port/Tube/Pipe Connection Description

Symbol	Description
B3	Braze Socket – silver braze
CP1	Connector Plate – Code 61
CP2	Connector Plate – Code 62
FCC1	Flange Clamp, Captive – Code 61
FCC2	Flange Clamp, Captive – Code 62
FCCT1	Flange Clamp, Captive with Tapped Holes – Code 61
FCCT2	Flange Clamp, Captive with Tapped Holes – Code 62
FCS1	Flange Clamp, Split – Code 61
FCS2	Flange Clamp, Split – Code 62
G	NPTF Port
G3	BSPT Port
G4	BSPP Port
G5	SAE Port
P	Plug (blanking end)
SP	Spacer w/o Gage Ports
SPG	Spacer w/ 1/4-18 NPTF Gage Port
SPG5	Spacer w/ 7/16-20 UNF Gage Port
SPGG5	Spacer w/ 1/4-18 NPTF & 7/16-20 UNF Ports
WSD1	Weld Saddle – Pipe
WSD2	Weld Saddle – Tube
W4	Flat Weld Socket – Tube
W4S	Flat Weld Socket – Tube (shallow)
W5	Flat Weld Socket – Pipe
W5S	Flat Weld Socket – Pipe (shallow)
W6	Extended Weld Socket – Tube
W6S	Extended Weld Socket – Tube (shallow)
W7	Extended Weld Socket – Pipe
W7S	Extended Weld Socket – Pipe (shallow)
WB1	Weld Butt – Schedule 40
WB3	Weld Butt – Schedule 80
WB5	Weld Butt – Schedule 160
WB7	Weld Butt – Schedule XXS
WBT	Weld Butt – Tank Pilot
WPL	Weld Plate
W	Weld Socket
W2	Weld Nipple
W3 or WB	Weld Nipple – Weld Butt, Tube

Box 3 – Shape Description

Symbol	Description
None	Block and Pad, Straight*
E	Elbow 90°
H	Barstock, Straight
J	Tee

*The “Block” has O-Ring and drilled mounting holes, while the “Pad” has no O-Ring groove and tapped mounting holes.

Box 4 – Flange Connection Type

Symbol	Description
Q1	Code 61 Flange Head w/ O-Ring Groove
Q1N	Code 61 Flange Head w/o O-Ring Groove
Q2	Code 62 Flange Head w/ O-Ring Groove
Q2N	Code 62 Flange Head w/o O-Ring Groove
Q1B	Code 61 Flange Block w/ O-Ring Groove and Drilled Mounting Holes
Q1P	Code 61 Flange Block w/o O-Ring Groove and Drilled Mounting Holes
Q2B	Code 62 Flange Block w/ O-Ring Groove and Drilled Mounting Holes
Q2P	Code 62 Flange Pad w/o O-Ring Groove and Tapped Mounting Holes
QSB	Square Flange Block w/ O-Ring Groove and Drilled Mounting Holes
QSP	Square Flange Pad w/o O-Ring Groove and Tapped Mounting Holes

Box 5 – Mounting Style

Symbol	Description
Omit	Inch Mounting Bolts (screws)
M	Metric Mounting Bolts (screws)

Box 6 – Material

Symbol	Description
S	Steel, Zinc Plated (braze or weld parts may not be plated)
SX	Steel, Oil Dipped
SS	Stainless Steel

Box 7 – Kit Designation

Symbol	Description
Omit	Flange Only
K	Kit (O-Ring, 4 bolts and washers)

Dimensions and pressures for reference only, subject to change.



How to Order EO and EO-2 Fittings and Accessories

TFD Standard Nomenclature Construction

Box 1	Box 2	Box 3	Box 4	Box 5	Box 6	Box 7	Box 8	Box 9
Shape/Style	Tube Size (mm.)	EO-2 Designator	Pressure Series	Port Size/ Designator	Port Sealing Method Modifier	Modifier 1	Material	Modifier 2

TABLE OF CONTENTS

SECTION TABLE OF CONTENTS

Box 1 – Shape/Style Code			
Straights		Tees	
AS	Weld Connector	EL	Swivel Nut Run
AS_ /	Weld Flange	ET	Swivel Nut Branch
BFG	Square Flange Connector	GMA1/	Union w/ Test Point, Pin
DA	Distance Adapter	GMA3/	Union w/ Test Point, M16x2
DG101/	Rotary Union	LEE	Adjustable Run
DG102/	Rotary Connector	T	Union
DG107/	Rotary Bulkhead Union	TEE	Adjustable Branch
DVGE	Plain Bearing Rotary	TH	High Pressure Banjo
EGE	Swivel Nut Connector	TR	Reducer Union
EGEO	ISO 6149 Swivel Nut Connector	WV	Alternating Valve
ESV	Weld Bulkhead Union	Cross	
G	Union	K	Union
GAI	Female Connector	Accessories	
GE	Male Connector	D	Cutting Ring
GEO	ISO 6149 Connector	DKA	Metal Seal Ring
GFS_ /	Flange Connector	DKI	Pressure Gage Seal
GR	Reducer Union	DOZ	EO-2 Seal Ring
GZ	Swivel Union	DPR	Progressive Ring
GZR	Reducer Swivel Union	E	Insert
MAV	Gage Connector	ED	EOlastic Seal
MAVE	Swivel Nut Gage Connector	FM	EO-2 Functional Nut
RED	Tube End Reducer	GM	Bulkhead Locknut
SKA	Weld Adapter	KD	Plastic Seal
SV	Bulkhead Union	KDS	Elastomeric Seal
VKA1/	Test Point Connector, Pin	M	Tube Nut
VKA3/	Test Point Connector, M16x2	OR	O-Ring
90° Elbows		PSR	Progressive Ring (new)
BFW	Square Flange Connector	R	Tube
DG103/	Rotary Union	ROV	Plug
DG104/	Rotary Connector	VH	Insert
DG108/	Rotary Bulkhead Union	VKA	Cap
DVWE	Plain Bearing Rotary	VSTI	Hollow Hex Plug
EW	Swivel Nut	Valves	
SWVE	Banjo	RHD	Union Check
W	Union	RHV	Connector Check
WAS	Weld Connector	RHZ	Connector Check
WE	Male Connector	RHDI	Female Check
WEE	Adjustable	RVP	Cartridge Check
WFS_ /	Flange Connector	DV	Low Pressure Shut Off
WH	High Pressure Banjo	LD	Medium Pressure Shut Off
WSV	Bulkhead Union	VDHA	High Pressure Shut Off
Double 90° Elbows		VDHB	High Pressure Shut Off
DG105/	Rotary Union	KH	2-way Ball Valve
DG106/	Rotary Connector	KH3/2-	3-way Ball Valve
45° Elbows		WV	Alternating Union Tee
EV	Swivel Nut		
VEE	Adjustable		

Box 2 – Tube Size (mm.)
04
05
06
08
10
12
14
15
16
18
20
22
25
28
30
35
38
42

Box 3 – EO-2 Designator	
Z	EO-2 Assy.

Box 4 – Pressure Series	
LL	Very Light
L	Light
S	Heavy

Box 5 – Port Size/ Designator (optional)	
Metric	
M_	Metric Parallel
M_X_	Metric Parallel (Jump Size)
M_X_keg	Metric Taper
NPT – Inch	
1/8NPT	NPT Thread
1/4NPT	NPT Thread
3/8NPT	NPT Thread
1/2NPT	NPT Thread
3/4NPT	NPT Thread
1NPT	NPT Thread
1 1/3NPT	NPT Thread
1 1/2NPT	NPT Thread
SAE-ORB	
7/16UNF	Inch Parallel Thread
9/16UNF	Inch Parallel Thread
3/4UNF	Inch Parallel Thread
3/4UNF	Inch Parallel Thread
7/8UNF	Inch Parallel Thread
11/16UNF	Inch Parallel Thread
15/16UNF	Inch Parallel Thread
1 5/8UNF	Inch Parallel Thread
1 7/8UNF	
BSPP/BSPT	
R_	BSPP
R_/_keg	BSPT

Box 6 – Port Sealing Method Modifier (optional)	
ED	EOlastic Seal
OR	ISO 6149 O-Ring
Kds	Banjo Seal Ring

Box 7 – Modifier 1 (optional)	
OMD	Without Nut and Sleeve
VIT	FPM (omitted for Stainless)
NBR	Nitrile Seals (omitted for Steel and Brass)
_ _ B	Special Cracking Pressure (check valve)

Box 8 – Material	
CF	Chromium 6 Free
MS	Brass
71	Stainless Steel
VZ	Zinc Plated (tube only)

Box 9 – Modifier 2 (optional)	
X	Unassembled

Dimensions and pressures for reference only, subject to change.



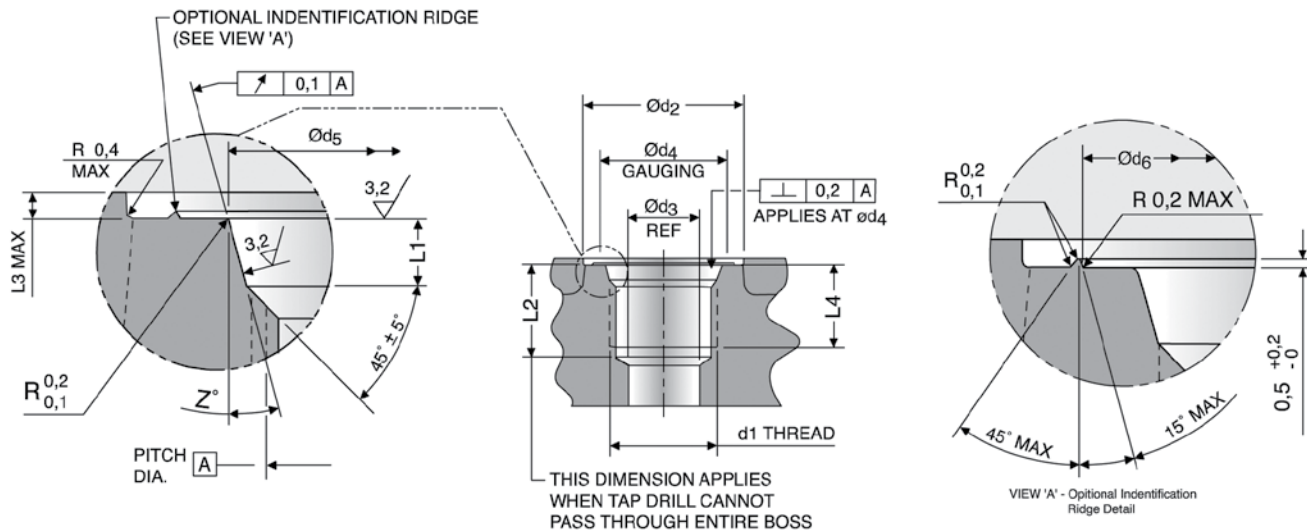
T

ISO 6149-1 – Metric Straight Thread O-Ring Port

(SAE 2244-1/DIN 3852, Part 3) Metric ISO 261, “M” Thread

TABLE OF CONTENTS

SECTION TABLE OF CONTENTS



Thread Size	Large d2 ²⁾	Small d2 ³⁾	d3 ⁴⁾	d4	d5	d6	L1	L ²⁾	L3	L4	Z°	Parker O-Ring Size ⁶⁾
d1 ¹⁾	min	min.	ref.		+0.1 0	+0.5 0	+0.4 0	min.	max	min. full thread	±1°	
M8 X 1	17	14	3	12.5	9.1	14	1.6	11.5	1	10	12°	M8 ISO O-Ring
M10 X 1	20	16	4.5	14.5	11.1	16	1.6	11.5	1	10	12°	M10 ISO O-Ring
M12 X 1.5	23	19	6	17.5	13.8	19	2.4	14	1.5	11.5	15°	M12 ISO O-Ring
M14 X 1.5	25	21	7.5	19.5	15.8	21	2.4	14	1.5	11.5	15°	M14 ISO O-Ring
M16 X 1.5	28	24	9	22.5	17.8	24	2.4	15.5	1.5	13	15°	M16 ISO O-Ring
M18 X 1.5	30	26	11	24.5	19.8	26	2.4	17	2	14.5	15°	M18 ISO O-Ring
M22 X 1.5	33	29	14	27.5	23.8	29	2.4	18	2	15.5	15°	M22 ISO O-Ring
M27 X 2	40	34	18	32.5	29.4	34	3.1	22	2	19	15°	M27 ISO O-Ring
M30 X 2	44	38	21	36.5	32.4	38	3.1	22	2	19	15°	M30 ISO O-Ring
M33 X 2	49	43	23	41.5	35.4	43	3.1	22	2.5	19	15°	M33 ISO O-Ring
M42 X 2	58	52	30	50.5	44.4	52	3.1	22.5	2.5	19.5	15°	M42 ISO O-Ring
M48 X 2	63	57	36	55.5	50.4	57	3.1	25	2.5	22	15°	M48 ISO O-Ring
M60 X 2	74	67	44	65.5	62.4	67	3.1	27.5	2.5	24.5	15°	M60 ISO O-Ring

FOR CARTRIDGE VALVE CAVITIES ONLY (SEE ISO 7789)

M20X1.5 ⁷⁾	32	27	--	25.5	21.8	27	2.4	--	2	14.5	15°	M20 ISO O-Ring
-----------------------	----	----	----	------	------	----	-----	----	---	------	-----	----------------

Table T23 – Port Detail – ISO 6149-1

- 1) Per ISO 261 tolerance class 6H. Tap drill per ISO 2306 class 6H.
- 2) Spotface diameter with the optional identification ridge.
- 3) Spotface diameter without identification ridge. Port to be identified by marking “metric” next to it or “ISO 6149-1 Metric” on component name plate.
- 4) Reference only. Connecting hole application may require a different size.
- 5) Tap drill depths given require use of a bottoming tap to produce the specified full thread lengths. Where standard taps are used, increase tap drill depths accordingly.
- 6) Preferred for diagnostic port applications.
- 7) For cartridge valve cavity applications only.
- 8) 90 durometer nitrile is standard for hydraulic applications.

NOTE: For port tapping tools, see pages R37 and R38. See page S6 for assembly torques.

Dimensions and pressures for reference only, subject to change.

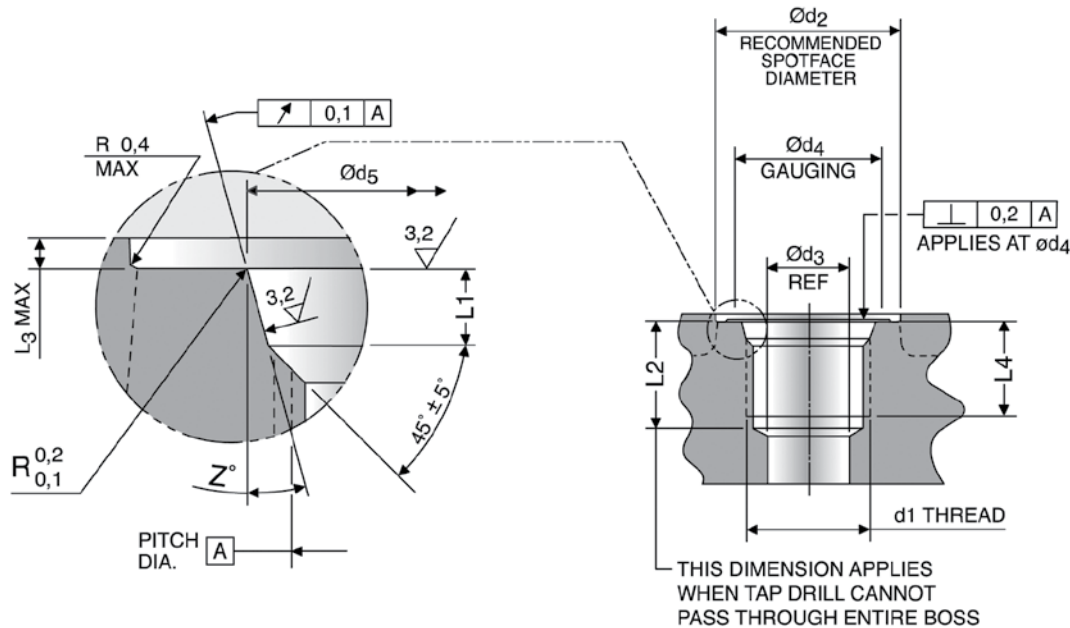


SAE J1926-1 – SAE Straight Thread O-Ring Port (ISO 11926-1)

(Conforms to MS16142. Does NOT conform to MS33649⁽⁸⁾.)

UN/UNF Threads

TABLE OF CONTENTS
SECTION TABLE OF CONTENTS



Nominal Tube OD ¹⁾			Thread Size ANSI B1.1 (ISO 263) (in.)	d2 dia. ³⁾ (mm.)	d3 dia. min. (mm.)	d4 dia. min. (mm.)	d5 dia. ⁴⁾ +0.13 -0.00 (mm.)	L1 +0.4 -0.00 (mm.)	L2 ⁵⁾ min. (mm.)	L3 ^{3), 6)} min. (mm.)	L4 Full Thread min. (mm.)	Z ±1° deg.	Parker O-Ring Size ⁷⁾
Nom ²⁾ SAE Dash Size	Inch (in.)	Metric (mm.)											
-2	1/8	---	5/16-24 UNF-2B	17	1.6	11	9.1	1.9	12.0	1.6	10.0	12°	3-902
-3	3/16	4	3/8-24 UNF-2B	19	3.2	13	10.7	1.9	12.0	1.6	10.0	12°	3-903
-4	1/4	6	7/16-20 UNF-2B	21	4.4	15	12.4	2.4	14.0	1.6	11.5	12°	3-904
-5	5/16	8	1/2-20 UNF-2B	23	6.0	16	14.0	2.4	14.0	1.6	11.5	12°	3-905
-6	3/8	10	9/16-18 UNF-2B	25	7.5	18	15.6	2.5	15.5	1.6	12.7	12°	3-906
-8	1/2	12	3/4-16 UNF-2B	30	10.0	22	20.6	2.5	17.5	2.4	14.3	15°	3-908
-10	5/8	14, 15, 16	7/8-14 UNF-2B	34	12.5	26	23.9	2.5	20.0	2.4	16.7	15°	3-910
-12	3/4	18, 20	1 1/16-12 UN-2B	41	16.0	32	29.2	3.3	23.0	2.4	19.0	15°	3-912
-14	7/8	22	1 3/16-12 UN-2B	45	18.0	35	32.3	3.3	23.0	2.4	19.0	15°	3-914
-16	1	25, 28	1 5/16-12 UN-2B	49	21.0	38	35.5	3.3	23.0	3.2	19.0	15°	3-916
-20	1 1/4	30, 32, 35	1 5/8-12 UN-2B	58	27.0	48	43.5	3.3	23.0	3.2	19.0	15°	3-920
-24	1 1/2	38, 42	1 7/8-12 UN-2B	65	33.0	54	49.8	3.3	23.0	3.2	19.0	15°	3-924
-32	2	50	2 1/2-12 UN-2B	88	45.0	70	65.7	3.3	23.0	3.2	19.0	15°	3-932

Table T24 – Port Detail – SAE J1926-1 (ISO 11926-1)

- Nominal tube OD is shown for the standard inch sizes and the conversion to equivalent millimeter sizes. Figures are for reference only, as any boss can be used for a tubing size depending upon other design criteria.
- See SAE J846 for more information.
- If face of boss is on a machined surface, dimensions d2 and L3 need not apply as long as corner radius R0.2 is maintained.
- Diameter d5 shall be concentric with thread pitch diameter within 0.004 in (0.1mm) FIM, and shall be free from longitudinal and spiral tool marks. Annular tool marks up to 100 µin (2.5µm) max. shall be permissible.
- Tap drill depths given require use of bottoming taps to produce the specified full thread lengths. Where standard taps are used, the tap drill depths must be increased accordingly.
- Maximum recommended spotface depth to permit sufficient wrench grip for proper tightening of the fitting or locknut.
- 90 durometer nitrile is standard for hydraulic applications.
- See page T34.

NOTE: For port tapping tools, see pages R35 and R36. For assembly torques see page S5.

Dimensions and pressures for reference only, subject to change.

ISO 6162 – Four-Bolt Flange Connection (Includes SAE J518)

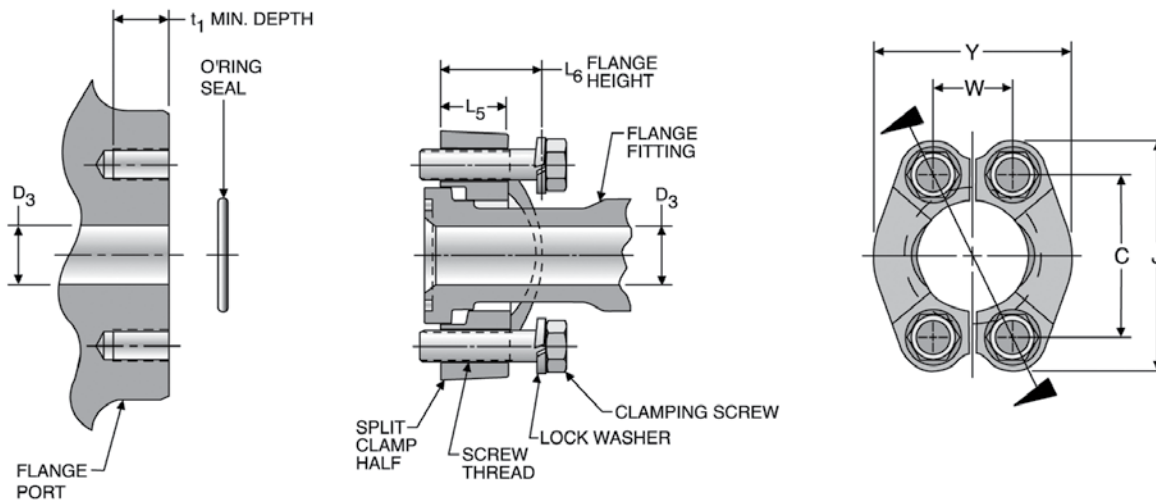


TABLE OF CONTENTS

SECTION TABLE OF CONTENTS

Nominal Flange Size D3		2.5 to 31.5 MPa Series ¹⁾ (SAE Code 61)											O-Rings ³⁾	
		Clamping Screws Screw Holes				Flange Half and Bolt Pattern								
		Type I		Type II ²⁾ (SAE J518)		C	J		W	Y	L5	L6	ISO 3601-1 ID x Section	Parker O-Ring Size
(in.)	(mm.)	Thread	t, Min. depth	Thread (UNC)	t, Min. depth	± 0.25	max.	min.	± 0.25	Ref.				
1/2	13	M8 x 1.5	12.5	5/16 - 18	24	38.1	54.9	53.1	17.5	46	13	19	19 x 3.55	2-210
3/4	19	M10 x 1.5	16.5	3/8 - 16	22	47.6	65.8	64.3	22.3	52	14	22	25 x 3.55	2-214
1	25	M10 x 1.5	14.5	3/8 - 16	22	52.4	70.6	69.1	26.2	59	16	22	32.5 x 3.55	2-219
1 1/4	32	M10 x 1.5	16.5	7/16 - 14	28	58.7	80.3	78.5	30.2	73	14 ⁴⁾	24	37.5 x 3.55	2-222
1 1/2	38	M12 x 1.75	19.5	1/2 - 13	27	69.9	94.5	93.0	35.7	83	16	25	47.5 x 3.55	2-225
2	51	M12 x 1.75	19.5	1/2 - 13	27	77.8	103.1	100.1	42.9	97	16	26	56 x 3.55	2-228
2 1/2	64	M12 x 1.75	21.5	1/2 - 13	30	88.9	115.8	112.8	50.8	109	19	38	69 x 3.55	2-232
3	76	M16 x 2	28.5	5/8 - 11	30	106.4	136.7	133.4	61.9	131	22	41	85 x 3.55	2-237
3 1/2	89	M16 x 2	28.5	5/8 - 11	33	120.7	153.9	150.9	69.9	140	22	28	97.5 x 3.55	2-241
4	102	M16 x 2	25.5	5/8 - 11	30	130.2	163.6	160.3	77.8	152	25	35	112 x 3.55	2-245
5	127	M16 x 2	27.5	5/8 - 11	33	152.4	182.6	185.7	92.1	181	28	41	136 x 3.55	2-253

Nominal Flange Size D3		40 MPa Series ¹⁾ (SAE Code 62)											O-Rings ³⁾	
		Clamping Screws Screw Holes				Flange Half and Bolt Pattern								
		Type I		Type II ²⁾ (SAE J518)		C	J		W	Y	L5	L6	ISO 3601-1 ID x Section	Parker O-Ring Size
(in.)	(mm.)	Thread	t, Min. depth	Thread (UNC)	t, Min. depth	± 0.25	max.	min.	± 0.25	Ref.				
1/2	13	M8 x 1.5	14.5	5/16 - 18	21	40.5	57.2	55.6	18.2	48	16	22	19 x 3.55	2-210
3/4	19	M10 x 1.5	16.5	3/8 - 16	24	50.8	72.1	70.6	23.8	60	19	28	25 x 3.55	2-214
1	25	M12 x 1.75	21.5	7/16 - 14	27	57.2	81.8	80.3	27.8	70	24	33	32.5 x 3.55	2-219
1 1/4	32	M12 x 1.75	18.5	1/2 - 13	25	66.6	96.0	94.5	31.8	78	27	38	37.5 x 3.55	2-222
1 1/2	38	M16 x 2	25.5	5/8 - 11	35	79.3	114.3	111.3	36.5	95	30	43	47.5 x 3.55	2-225
2	51	M20 x 2.5	33.5	3/4 - 10	38	96.8	134.9	131.8	44.5	114	37	52	56 x 3.55	2-228

Table T25 – Port Detail – ISO 6162

- 1) 1 MPa = 10 bar = 145 PSI.
- 2) Not for new design.
- 3) 90 durometer nitrile is standard for hydraulic applications.

NOTE: For port tapping tools, see pages R35 and R36. See page S8 for assembly torques.

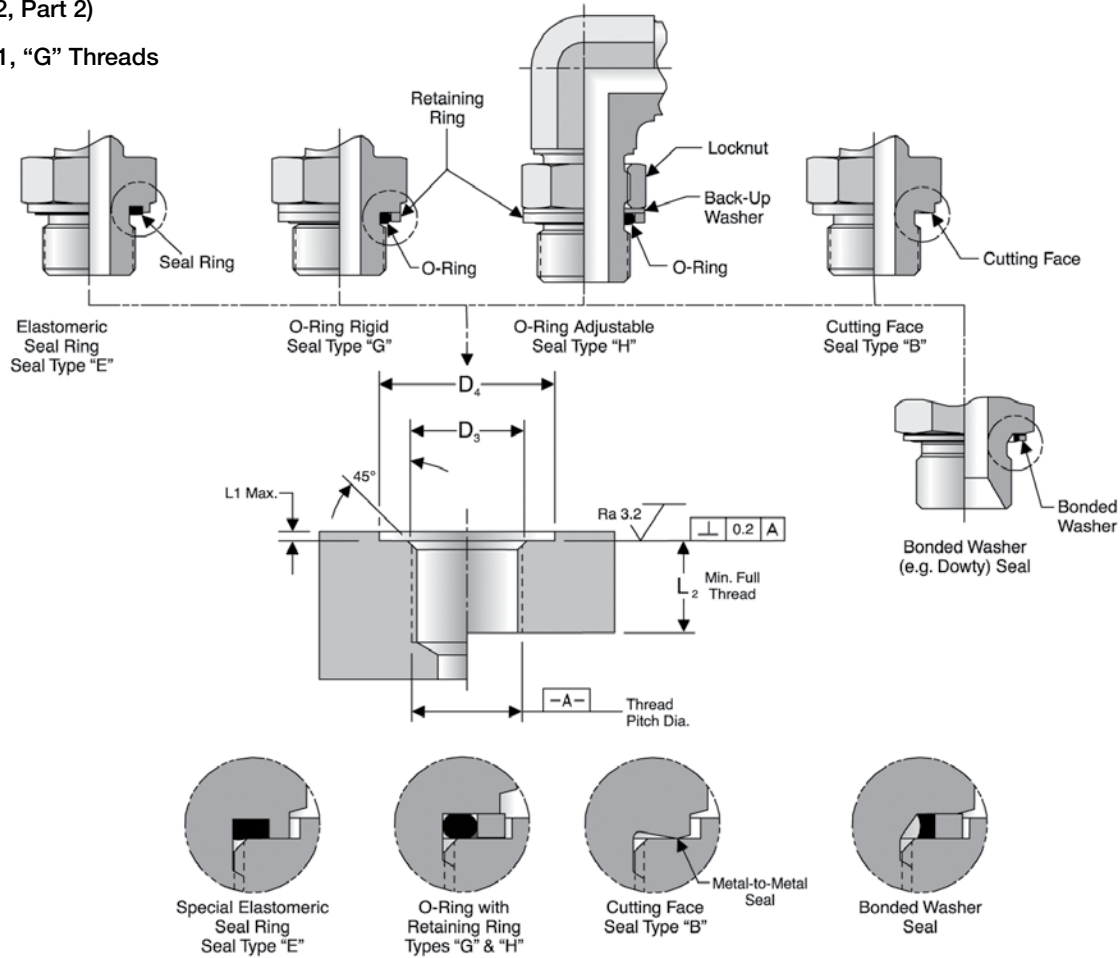
Dimensions and pressures for reference only, subject to change.



ISO 1179-1¹⁾ – Flat Face Port with British Standard Pipe, Parallel (BSPP) Threads

(DIN 3852, Part 2)

ISO 228-1, “G” Threads



Port Sealing Methods

Thread Size (ISO 228-1)	D3 (mm.)	D4 (mm.)		L1 max. (mm.)	L2 min. (mm.)	EOlastic Seal (Type E)		O-Ring and Retaining Ring ³⁾ (Types G & H)		Bonded Washer Part No. ⁴⁾
		Narrow Types B & E	Wide Types G & H			Part No.	O-Ring Size ²⁾	O-Ring ID x section (mm.)	Retaining Ring Part No.	
G 1/8-28	9.9	15	17.2	1.0	8.5	ED10X1X	5-585	7.98 x 1.88	1/8 RR	D9DT-2
G 1/4-19	13.3	20	20.7	1.5	12.5	ED14X1.5X	2-111	10.77 x 2.62	1/4 RR	D9DT-4
G 3/8 19	16.8	23	24.5	2.0	12.5	EDR3/8X	2-113	13.94 x 2.62	3/8 RR	D9DT-6
G 1/2-14	21.1	28	34.0	2.5	14.5	EDR1/2X	5-256	17.96 x 2.62	1/2 RR	D9DT-8
G 3/4-14	26.6	33	40.0	2.5	16.5	ED26X1.5X	2-119	23.47 x 2.62	3/4 RR	D9DT-12
G 1-11	33.5	41	46.1	2.5	18.5	ED33X2X	2-217	29.74 x 3.53	1 RR	D9DT-16
G 1 1/4-11	42.2	51	54.0	2.5	20.5	ED42X2X	2-222	37.69 x 3.53	1 1/4 RR	D9DT-20
G 1 1/2-11	48.1	56	60.5	2.5	22.5	ED48X2X	2-224	44.04 x 3.53	1 1/2 RR	D9DT-24
G 2-11	59.9	69	73.3	3.0	26.0	—	—	—	—	D9DT-32

Table T26 – Port Detail – ISO 1179-1

- 1) Conforms to proposed revision.
- 2) 90 durometer nitrile is standard for hydraulic applications.
- 3) See page N6 for O-ring and retaining ring ordering information.
- 4) See page N7 for details.

Dimensions and pressures for reference only, subject to change.



TABLE OF CONTENTS

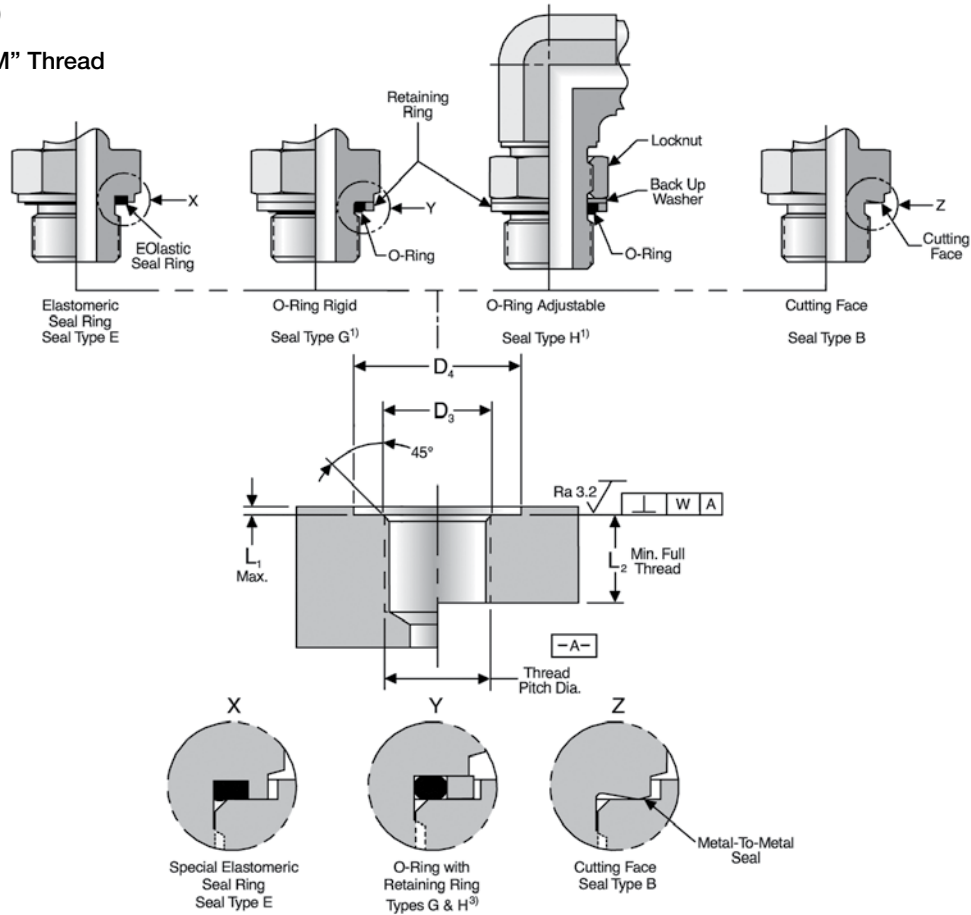
SECTION TABLE OF CONTENTS

T

ISO 9974-1 – Flat Face Port with Metric Threads

(DIN 3852, Part 1)

Metric ISO261, “M” Thread



(See Note 1)

ISO 9974 Port seal types available from Parker

Thread Size (ISO 261)	D3 (mm.)	D4 (mm.)	L1 max. (mm.)	L2 min. (mm.)	W (mm.)	Elastic Seal (Type E)			
						Part No.	O-Ring Size ²⁾	O-Ring ID x section (mm.)	Retaining Ring Part No.
M8 x 1	8 +0.2	13	1	8		ED8X1X	3-902	6.07 x 1.63	M8 RR
M10 x 1	10 +0.2	15	1	8		ED10X1X	6-074	8.00 x 1.50	M10 RR
M12 x 1.5	12 +0.2	18	1.5	12		ED12X1.5X	2-012	9.25 x 1.78	M12 RR
M14 x 1.5	14 +0.2	20	1.5	12	0.1	ED14X1.5X	2-013	10.82 x 1.78	M14 RR
M16 x 1.5	16 +0.2	23	1.5	12		ED16X1.5X	3-907	13.46 x 2.08	M16 RR
M18 x 1.5	18 +0.2	25	2	12		ED18X1.5XX	2-114	15.54 x 2.62	M18 RR
M20 x 1.5 ³⁾	20 +0.2	27	2	14		ED20X1.5X	2-017	17.17 x 1.78	M20 RR
M22 x 1.5	22 +0.2	28	2.5	14		ED22X1.5X	2-018	18.77 x 1.78	M22 RR
M24 x 1.5 ⁴⁾	24 +0.2	30	2.5	14		—	2-019	20.35 x 1.78	M24 RR
M26 x 1.5	26 +0.2	33	2.5	16		ED26X1.5X	2-118	21.89 x 2.62	M26 RR
M27 x 2	27 +0.2	33	2.5	16		ED26X1.5X	2-119	23.47 x 2.62	M27 RR
M33 x 2	33 +0.3	41	2.5	18	0.2	ED33X2X	2-122	28.24 x 2.62	M33 RR
M36 x 2 ⁴⁾	36 +0.3	43	2.5	18		—	2-124	31.42 x 2.62	M36 RR
M42 x 2	42 +0.3	51	2.5	20		ED42X2X	2-128	37.77 x 2.62	M42 RR
M45 x 2 ⁴⁾	45 +0.3	50	2.5	20		—	2-130	40.94 x 2.62	M45 RR
M48 x 2	48 +0.3	56	2.5	22		ED48X2X	2-132	44.12 x 2.62	M48 RR

Table T27 – Port Detail – ISO 9974-1

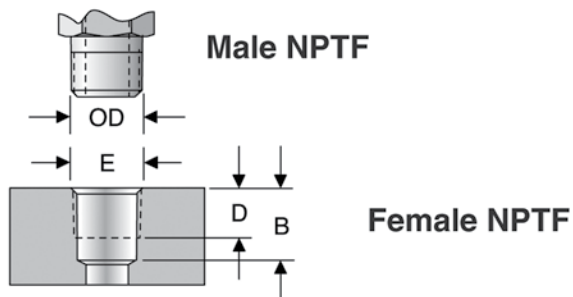
- 1) Seal types G and H are not covered in ISO 9974-1. See page N6 for retaining ring and O-Ring ordering information.
- 2) 90 durometer nitrile is standard for hydraulic applications.
- 3) For diagnostic applications.
- 4) These sizes are not covered in ISO 9974-1.

Dimensions and pressures for reference only, subject to change.

NPTF and BSPT Dimensions

TABLE OF CONTENTS

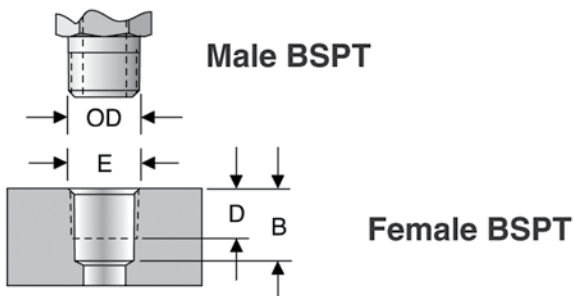
SECTION TABLE OF CONTENTS



Thread Size NPTF	O.D. Male Thread Large Dia.	D Min.. Thread Length	B Min.. Tap Drill Depth ¹⁾	E Chmf. Dia.
1/8-27	0.41	0.31	0.38	0.42
1/4-18	0.55	0.44	0.47	0.55
3/8-18	0.68	0.47	0.53	0.69
1/2-14	0.85	0.59	0.69	0.85
3/4-14	1.06	0.63	0.75	1.06
1-11 1/2	1.33	0.75	0.84	1.34
1 1/4-11 1/2	1.67	0.78	0.84	1.68
1 1/2-11 1/2	1.91	0.81	0.88	1.92
2-11 1/2	2.39	0.81	0.91	2.39

Table T28 – NPTF Dimensions

1) For bottoming taps only.



Thread Size BSPT	O.D. Male Thread Large Dia.	D Min.. Thread Length	B Min.. Tap Drill Depth ¹⁾	E Chmf. Dia.
1/8-28	0.39	0.31	0.38	0.42
1/4-19	0.53	0.44	0.47	0.55
3/8-19	0.67	0.47	0.53	0.69
1/2-14	0.84	0.59	0.69	0.85
3/4-14	1.06	0.63	0.75	1.06
1-11	1.33	0.75	0.84	1.34
1 1/4-11	1.67	0.78	0.84	1.68
1 1/2-11	1.90	0.81	0.88	1.92
2-11	2.37	0.81	0.91	2.39

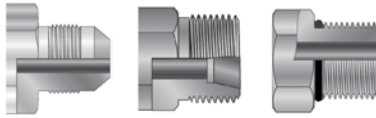
Table T29 – BSPT Dimensions

1) For bottoming taps only.

Dimensions and pressures for reference only, subject to change.

T

Thread Guide



Dash Size	Tube Size	Triple-Lok SAE 37° Flare	Ferulok SAE Flareless	SAE Straight Thread
2	1/8	5/16-24	5/16-24	5/16-24
3	3/16	3/8-24	3/8-24	3/8-24
4	1/4	7/16-20	7/16-20	7/16-20
5	5/16	1/2-20	1/2-20	1/2-20
6	3/8	9/16-18	9/16-18	9/16-18
8	1/2	3/4-16	3/4-16	3/4-16
10	5/8	7/8-14	7/8-14	7/8-14
12	3/4	1 1/16-12	1 1/16-12	1 1/16-12
16	1	1 5/16-12	1 5/16-12	1 5/16-12
20	1 1/4	1 5/8-12	1 5/8-12	1 5/8-12
24	1 1/2	1 7/8-12	1 7/8-12	1 7/8-12
32	2	2 1/8-12	2 1/8-12	2 1/8-12



Dash Size	Tube Size	Seal-Lok O-Ring Face Seal	SAE 45° Flare	N.P.T.
2	1/8	—	5/16-24	1/8-27
3	3/16	—	3/8-24	—
4	1/4	9/16-18	9/16-18	1/4-18
5	5/16	—	1/2-20	—
6	3/8	11/16-16	5/8-18	3/8-18
8	1/2	13/16-16	3/4-16	1/2-14
10	5/8	1-14	7/8-14	—
12	3/4	1 3/16-12	1 1/16-14	3/4-14
16	1	1 7/16-12	1 3/8-12	1-11 1/2
20	1 1/4	1 11/8-12	—	1 1/4-11 1/2
24	1 1/2	2-12	—	1 1/2-11 1/2
32	2	—	—	2-11 1/2

TABLE OF CONTENTS

SECTION TABLE OF CONTENTS

Dimensions and pressures for reference only, subject to change.



Appendix

U



Fitting Materials

Material				Product Type					
Type	Condition	Standard	Grade	Seal-Lok, Triple-Lok, Ferulok, Intru-Lok, Pipe, Port Adapters, JIS, Komatsu, Flanges				Welding Parts	
				Body	Nut	Sleeve	Ferrule		
Steel ¹⁾	Bar Stock	ASTM A108	12L14	•	•	•	•		
		ASTM A108	C1045	•	•	•			
		ASTM A108	C1018		•			•	
	Cold Form	ASTM A576	C1008		•	•	•		
		ASTM A576	C1010		•	•	•		
		ASTM A576	C1012		•	•	•		
		ASTM A576	C1020				•		
	Forging	ASTM A576	1214		•				
		ASTM A576	1215		•				
ASTM A576		C1045		•	•				
Stainless Steel ²⁾	Bar Stock	ASTM A479	316	•	•	•		•	
		ASTM A479	316L						
		ASTM A564	630				•		
	Cold Form	ASTM A479	316		•	•	•		•
		ASTM A479	316L						
	Forging	ASTM A182	316		•	•			
ASTM A182		316L							
Brass ³⁾	Bar Stock	ASTM B16	CA360	•	•		•		
		ASTM B453	CA345	•	•				
		ASTM B371	CA694			•			
	Cold Form	ASTM B121	CA335		•	•			
		ASTM B111	CA443			•			
		ASTM B111	CA444			•			
	Forging	ASTM B124	CA377		•				
Aluminum	Bar Stock	ASTM B211	2024-T351	•	•	•			
	Forging	AMS 4133	2014-T6	•					

¹⁾ Standard steel products have silver/clear zinc chromium 6 free plating. Brazing and welding products are not plated.

²⁾ Stainless steel fittings are passivated. Standard stainless steel nuts are coated to prevent galling during assembly.

³⁾ Brass is not available for Ferulok. Where brass is required, use Intru-Lok. Intru-Lok is only available in brass.

Table U1 — Standard Material Specifications

Material					Product Type		
Type	Condition	Standard	Grade	U.S. Equivalent grade	EO, EO2, K4		
					Body	Nut	Welding Parts
Steel ¹⁾	Bar Stock	DIN EN 10277-3	1.0718	12L14	•		
		DIN EN 10277-3	1.0715	1213	•		
		DIN EN 10277-3	1.0727	1146	•		
		DIN EN 10277-3	1.0401	C1015			•
	Cold Form	DIN EN 10263	1.0214	C1010		•	
		DIN 1651	1.0710		•		
		DIN EN 10087	1.0764		•		
Forging	DIN EN 10083	1.0503	C1045 modified		•		
Stainless Steel	Bar Stock	DIN EN 10088	1.4571	316TI	•	•	•
	Forging	DIN EN 10088	1.4571	316TI	•	•	•
Brass	Bar Stock	DIN 17660	2.0540		•	•	
	Forging	DIN 17660	2.0540		•		

¹⁾ Standard steel products have silver/clear zinc chromium 6 free plating. Brazing and welding products are not plated.

Table U2 — Standard Material Specifications for EO and K4 Product





Recommended Tube Wall Thickness

Fitting Dash Size	Tube O.D. (inch)	Product Type					
		Recommended Wall Thickness (Inch)					
		Seal-Lok		Triple-Lok		Ferulok	
		Min.	Max.	Min.	Max.	Min.	Max. ¹⁾
-2	1/8	-	-	0.010	0.035	0.010	0.035
-3	3/16	-	-	0.010	0.035	0.020	0.049
-4	1/4	0.020	0.083	0.020	0.065	0.028	0.065
-5	5/16	-	-	0.020	0.065	0.028	0.065
-6	3/8	0.020	0.109	0.020	0.065	0.035	0.095
-8	1/2	0.028	0.148	0.028	0.083	0.049	0.120
-10	5/8	0.035	0.134	0.035	0.095	0.058	0.120
-12	3/4	0.035	0.148	0.035	0.109	0.065	0.120
-14	7/8	0.035	0.156	0.035	0.109	0.072	0.120
-16	1	0.035	0.188	0.035	0.120	0.083	0.148
-20	1 1/4	0.049	0.220	0.049	0.120	0.095	0.188
-24	1 1/2	0.049	0.250	0.049	0.120	0.095	0.220
-32	2	0.058	0.250	0.058	0.134	0.095	0.220

¹⁾ Thicker tubing may be used, but pressure capability is limited by fitting.
²⁾ Please consult Parker Hannifin Tube Fittings Division for tube sizes not listed.

Table U3 — Recommended Inch Tube Wall Thickness

Tube O.D. (mm)	Fitting Size	Metric Tube					
		Recommended Wall Thickness (mm)					
		Seal-Lok			Triple-Lok		
		Min.	Max.	Fitting Size	Min.	Max.	Fitting Size
6	-4	0.5	2.25	-4	0.5	2.0	
8	-6	1.0	2.5	-5	0.5	2.0	
10	-6	1.0	3.0	-6	0.5	2.0	
12	-8	1.0	3.5	-8	1.0	2.0	
14	-10	1.0	4.0	-10	1.0	2.5	
15	-10	1.0	3.0	-10	1.0	2.5	
16	-10	1.0	3.0	-10	1.0	2.5	
18	-12	1.0	3.0	-12	1.0	3.0	
20	-12	1.5	4.0	-12	1.0	3.0	
22	-16	1.0	3.0	-14	1.0	3.0	
25	-16	2.0	5.0	-16	1.0	3.0	
28	-20	1.5	5.0	-	-	-	
30	-20	2.0	5.0	-20	1.5	3.0	
32	-20	2.0	2.5	-20	1.5	3.0	
35	-24	2.0	6.0	-	-	-	
38	-24	2.5	7.0	-24	1.5	3.0	
50	-	-	-	-32	1.5	3.5	

Table U4 — Recommended Metric Tube Wall Thickness

Tube End Connections

Threads, Conformance Specifications and Use

TABLE
 OF
 CONTENTS

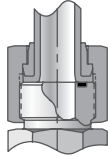
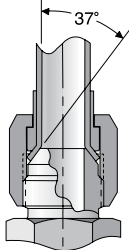
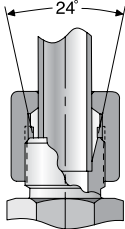
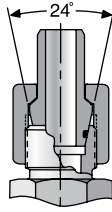
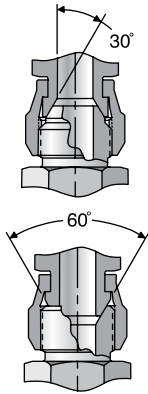
			SAE J514 ISO 8434-1 JIS B2351  		ISO 8434-4 	
Description	O-Ring Face Seal (ORFS) "Seal-Lok"	37° Flare "Triple-Lok"	Inch 24° Cone Flareless "Ferulok"	Metric 24° Cone Flareless "EO" and "EO2"	Metric 24° Cone Flareless "JIS"	30° Flare and 60° Cone "JIS"
Thread Type	ISO 263 ANSI B1.1 unified	ISO 263 ANSI B1.1, unified	ISO 263 ANSI B1.1, unified	ISO 261 Metric fine	ISO 261 JIS B 0207	ISO 228-1 JIS B0202, BS2779
ISO No.	8434-3 (12151-1) ¹⁾	8434-2 (12151-6) ¹⁾	—	8434-1 & -4 (12151-2) ¹⁾	—	—
SAE No.	J1453/J516 ²⁾	J514/J516 ²⁾	J514	—	—	—
DIN No.	—	—	—	3861, 3865 & 20078 ²⁾	—	—
JIS No.	—	—	—	Similar to B2351	B2351	B8363 ³⁾
BSI No.	—	—	—	—	—	Similar to BS 5200 ⁴⁾
Current use	Mainly used in North America slowly gaining acceptance in Europe and Japan.	Used throughout the world with major usage in North America.	Mainly used in North America.	Mainly used in Europe. Slowly gaining acceptance in North America.	Mainly used in Japan for hard plumbed systems.	Mainly used in Japan, U.K. and British commonwealth countries.

Table U5 — Tube End Connections

- 1) Hose fitting specification no.
- 2) Hose fitting specification no.
- 3) Adapter and hose fitting specification no.
- 4) 60° cone fittings only. See page U6 for more information.

Dimensions and pressures for reference only, subject to change.

Tube End Connections Thread Size Guide — Inch Thread

Tube O.D. or Adapter Size			O-ring Face Seal (ORFS)	37° Flare	Inch 24° cone ³⁾ Flareless	SAE 45° Flare ³⁾
Nominal metric size ³⁾	Nominal Inch		SAE J1453	SAE J514	SAE J514	SAE J512
	size	SAE dash size	“Seal-Lok”	“Triple-Lok”	“Ferulok”	
(mm)	(in)		Inch ANSI B1.1, unified (ISO 263)	Inch ANSI B1.1, unified (ISO 263)	Inch ANSI B1.1, unified (ISO 263)	Inch ANSI B1.1, unified (ISO 263)
—	1/8	-2	—	5/16-24	5/16-24	5/16-24
4	—	—	—	—	—	—
5	3/16	-3	—	3/8-24	3/8-24	3/8-24
6	1/4	-4	9/16-18	7/16-20	7/16-20	7/16-20
8	5/16	-5	—	1/2-20	1/2-20	1/2-20
10	3/8	-6	11/16-16	9/16-18	9/16-18	5/8-18
12	1/2	-8	13/16-16	3/4-16	3/4-16	3/4-16
14	5/8	-10	1-14	7/8-14	7/8-14	7/8-14
15 ¹⁾	5/8	-10	1-14	7/8-14	—	—
16	5/8	-10	1-14	7/8-14	—	—
18 ¹⁾	3/4	-12	1 3/16-12	1 1/16-12	1 1/16-12	1 1/16-14
20	3/4	-12	1 3/16-12	1 1/16-12	—	—
22 ¹⁾	7/8	-14	—	1 3/16-12	1 3/16-12	—
25	1	-16	1 7/16-12	1 5/16-12	1 5/16-12	—
28 ¹⁾	1 1/4	-20	1 11/16-12	—	1 5/8-12	—
30	1 1/4	-20	1 11/16-12	1 5/8-12	—	—
32 ²⁾	1 1/4	-20	1 11/16-12	1 5/8-12	—	—
38	1 1/2	-24	2-12	1 7/8-12	1 7/8-12	—
50	2	-32	2 1/2-12	2 1/2-12	2 1/2-12	—

Table U6 — Tube End Connections

- 1) Not preferred for high pressure applications.
- 2) Non-preferred size. Use 30mm size in place of 32mm size.
- 3) Metric tube sizes do not apply to “Ferulok” and 45° flare fittings.

Dimensions and pressures for reference only, subject to change.

Tube End Connections Thread Size Guide — Metric, BSPP and JIS Threads

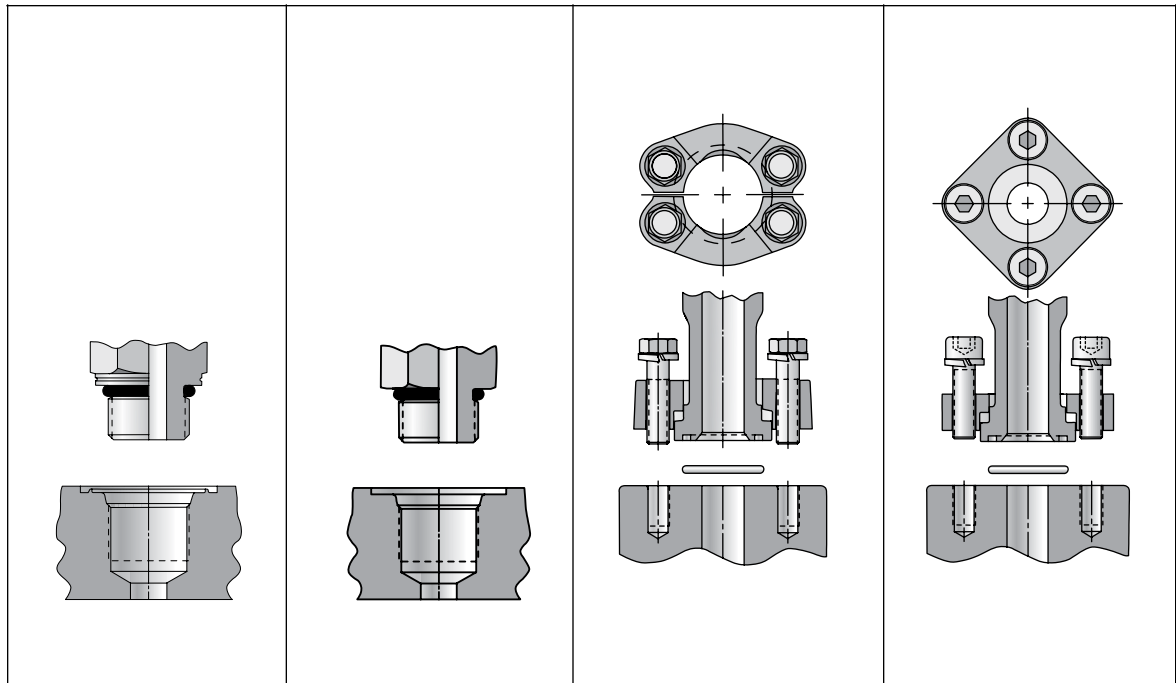
Tube O.D. or Adapter Size (mm)	Metric 24° cone			Metric 24° cone Flareless	60° Cone	30° Flare and 60° Cone
	Flareless DIN 3861 LL Series Metric ISO 261	Weld Nipple DIN 3865 L Series Metric ISO 261	“EO” and “EO-2” S Series Metric ISO 261	JIS B2351 “JIS” Metric ISO 261 (JIS B0207)	BS 5200 ISO 228-1 (BSPP) ⁵⁾	JIS B8363 ISO 228-1 (JIS B 0202) (BSPP) ⁵⁾
—	—	—	—	—	—	—
4	M8 x 1	—	—	—	—	—
5	M10 x 1 ³⁾	—	—	—	—	—
6	M10 x 1	M12 x 1.5	M14 x 1.5	M12 x 1.5	G 1/8 A	G 1/4 B
8	M12 x 1	M14 x 1.5	M16 x 1.5	M14 x 1.5	G 1/4 A	—
9 ²⁾	—	—	—	—	—	G 3/8 B
10	M14 X 1 ⁴⁾	M16 x 1.5	M18 x 1.5	M16 x 1.5	G 3/8 A	—
12	M16 x 1 ⁴⁾	M18 x 1.5	M20 x 1.5	M18 x 1.5	G 1/2 A	G 1/2 B
14	—	—	M22 x 1.5	—	—	—
15 ¹⁾	—	M22 x 1.5	—	—	—	—
16	—	—	M24 x 1.5	M24 x 1.5	G 5/8 A ⁶⁾	—
18 ¹⁾	—	M26 x 1.5	—	—	—	—
19 ²⁾	—	—	—	—	—	G 3/4 B
20	—	—	M30 x 2	M28 x 1.5	G 3/4 A	—
22 ¹⁾	—	M30 x 2	—	—	—	—
25	—	—	M36 x 2	M35 x 1.5	G 1 A	G 1 B
28 ¹⁾	—	M36 x 2	—	—	—	—
30	—	—	M42 x 2	M40 x 1.5	G 1-1/4 A	—
32 ²⁾	—	—	—	—	—	G 1-1/4 B
35 ¹⁾	—	M42 x 2	—	—	—	—
38	—	—	M52 x 2	M48 x 1.5	G 1-1/2 A	G 1-1/2 B
42 ¹⁾	—	M52 x 2	—	—	—	—
50	—	—	—	—	G 2 A	G 2 B

Table U7— Tube End Connections

- 1) Not preferred for high pressure applications.
- 2) Not preferred sizes. Use 10mm, 20mm and 30mm sizes in place of 9mm, 19mm and 32mm sizes, respectively.
- 3) Covered in ISO 8434-1. Non-standard with Parker TFDE (Ermeto).
- 4) Not part of DIN or ISO standards, but offered by Parker TFDE (Ermeto).
- 5) ISO 228-1 G threads and JIS B 0202 G or PF threads can be interchanged. “A” and “B” indicate different tolerance classes on the male threads, “A” having tighter tolerances than “B”.
- 6) Non-preferred size.

Dimensions and pressures for reference only, subject to change.

Port End Connections Threads, Conformance Specifications, and Use



Port Description	Metric Straight Thread O-Ring Port	SAE Straight Thread O-Ring Port	Four Screw Split Flange	Four Screw One Piece Square Flange
Thread Type	ISO 261 Metric Fine	ISO 263 ANSI B1.1, Unified	Metric screws: ISO 261 Inch screws: ISO 263	ISO 261
ISO No.	6149	11926	6162	6164
SAE No.	J2244	J1926	J518 (covers inch screws only)	—
DIN No.	3852-3 Form "W"	—	—	—
JIS No.	—	—	B8363 (covers flange head only)	—
BSI No.	—	—	—	—
Current use	Gaining use in U.S. and western Europe. Widely used in former Soviet block countries.	Widely used in North America. Limited use in the rest of the world.	Widely used throughout the world.	Mainly used in Germany. Limited use elsewhere.

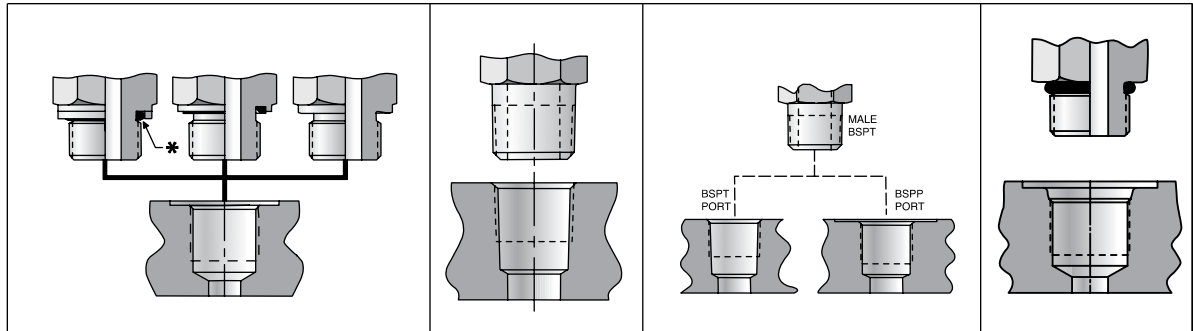
Table U8 — Port End Connections

U

Dimensions and pressures for reference only, subject to change.

Port End Connections

Threads, Conformance Specifications, and Use



Port Description	British Standard Pipe Parallel (BSPP) Flat Face Port	Metric Straight Thread Flat Face Port	NPTF - Dryseal American Standard Taper Pipe	JIS/BSPT British Standard Pipe, Taper	JIS/BSPP British Standard Pipe, Parallel O-ring Port
Thread Type	ISO 228-1 BS 2779	ISO 261 Metric Fine	ANSI B1.20.3	ISO 7 BS 21 JIS B 0203	ISO 228-1 BS 2779 JIS B 0202
ISO No.	1179	9974	—	—	—
SAE No.	—	—	J476	—	—
DIN No.	3852-2 Form X or Y	3852-1 Form X or Y	—	Similar to: 3852-2 form Z	—
JIS No.	—	—	—	B8363	B2351 Type "O"
BSI No.	—	—	—	—	Similar to BS 5380
Current use	Most popular in western Europe and former UK colonies. Limited use in rest of the world.	Moderate use in Europe, mainly in Germany.	Mainly used in North America some use in rest of the world.	Mainly used in Japan and parts of western Europe.	Mainly used in Japan. Some use in U.K. of similar port, BS5380.

Table U9 — Port End Connections

Dimensions and pressures for reference only, subject to change.



Hydra-Tool Pre-Setting Pressures for EO and EO-2 Steel Fittings

Pressures for Steel EO Fittings Using Stop Adapter (971107 & 971108)

Pre-Setting Pressures (psi) for EO Fittings Wall Thickness (mm)							
Size	Series	1.0	1.5	2.0	2.5	3.0	4.0
6	L	500	500	500			
6	S	500					
8	L	500		500			
8	S	500	500				
10	L		500				
10	S		500				
12	L	300	300	500			
12	S		300				
14	S			1,500			
15	L		500	800			
16	S			1,200		1,300	
18	L		1,000			1,300	
20	S				2,000		
22	L		1,500	1,500			
25	S					2,000	2,000
28	L			2,000			
30	S					3,000	
35	L			3,000		3,300	
38	S						3,500
42	L					4,000	

Table U10 — Pre-Setting Pressures for Steel EO Fittings

NOTE: The values provided in this chart are provided as a guide only and normally will produce a satisfactory bite when using the Parker Hydra-Tool.

Pressures for Steel EO-2 Fittings Using Stop Adapter (971107 & 971108)

Hydra-Tool Pre-Setting Pressures (psi) for EO-2 Fittings in Steel and Stainless Steel Using the Stop Adapter		
Size	Series	psi
6	L	1,100
6	S	1,100
8	L	1,300
8	S	1,300
10	L	1,800
10	S	1,800
12	L	2,000
12	S	2,000
14	S	2,300
15	L	2,300
16	S	3,000
18	L	3,000
20	S	4,100
22	L	3,100
25	S	5,500
28	L	3,700
30	S	6,600
35	L	5,300
38	S	8,400
42	L	7,600

Table U11 — Pre-Setting Pressures for Steel and Stainless Steel EO-2 Fittings

NOTE: The values provided in this chart are provided as a guide only and normally will produce a satisfactory bite when using the Parker Hydra-Tool.

Hydra-Tool Pre-Setting Pressures for Ferulok Fittings^{1) 2) 3)}

Tube Size	Wall Thickness – Steel							Wall Thickness – Stainless Steel						
	0.035	0.049	0.065	0.083	0.095	0.109	0.120	0.035	0.049	0.065	0.083	0.095	0.109	0.120
4	300	300	500	600	600	600		300	300	500	700	700	700	
6	300	500	600	700	700	700	700	300	500	700	700	700	700	800
8		500	700	800	900	1,000	1,000		600	700	1,000	1,000	1,100	1,100
10			700	900	1,000	1,100	1,100			800	1,000	1,100	1,300	1,300
12			900	1,000	1,100	1,100	1,300			1,000	1,100	1,300	1,300	1,500
14			1,000	1,100	1,100	1,300	1,500			1,000	1,300	1,300	1,500	1,600
16				1,100	1,300	1,500	1,600				1,500	1,500	1,600	1,600
20					1,500	1,600	1,800					1,600	2,000	2,000
24					1,800	2,000	2,300					2,100	2,300	2,300
32					2,800	2,900	3,300					3,100	3,300	3,300

Table U12 — Hydra-Tool Recommended Pre-Setting Pressures for Inch Tube

- 1) These values are provided as a guide only and normally will produce a satisfactory bite.
- 2) Ferulok pre-setting dies are positive stop dies. Use of above pressures is optional.
- 3) For wall thicknesses greater than those listed, contact the Tube Fittings Division.

Dimensions and pressures for reference only, subject to change.





Hyferset Pre-Setting Pressures for Ferulok Fittings¹⁾

Tube Size	Wall Thickness — Steel							Wall Thickness — Stainless Steel						
	0.035	0.049	0.065	0.083	0.095	0.109	0.120	0.035	0.049	0.065	0.083	0.095	0.109	0.120
4	800	900	1,400	1,800	1,800	1,800		900	1,000	1,500	2,000	2,000	2,000	
6	900	1,400	1,800	2,000	2,000	2,000	2,200	1,000	1,500	2,000	2,000	2,000	2,000	2,500
8		1,600	2,000	2,500	2,700	3,000	3,200		1,800	2,200	3,000	3,000	3,500	3,500
10			2,200	2,700	3,000	3,500	3,500			2,500	3,000	3,500	4,000	4,000
12			2,700	3,000	3,500	3,500	4,000			3,000	3,500	4,000	4,000	4,500
14			3,000	3,500	3,500	4,000	4,500			3,000	4,000	4,000	4,500	5,000
16				3,500	4,000	4,500	5,000				4,500	4,500	5,000	5,000
18				4,000	4,500	4,500	5,000				4,500	5,000	5,000	5,500
20					4,500	5,000	5,500					5,000	6,000	6,000
24					5,500	6,000	7,000					6,500	7,000	7,000
28					7,000	7,500	8,000					7,500	8,000	8,500
32					8,500	9,000	10,000					9,500	10,000	10,000

Table U13 — Pre-Setting Pressures for Ferulok Fittings

1) Ferulok pre-setting dies are positive stop dies. Use of above pressures is optional.

Hyferset Pre-Setting Pressures for EO Steel Fittings²⁾

Pre-Setting Pressures (psi) for EO Fittings					
Tube Size (mm)	Wall Thickness (mm)				
	1.0	1.5	2.0	2.5	3.0
6-L	650	650			
6-S	650	650			
8-L	900	900			
8-S	900	900			
10-L	1,350	1,350	1,550		
10-S	1,350	1,350	1,550		
12-L	1,750	1,750	1,750	1,750	
12-S	1,750	1,750	1,750	1,750	
14-S		2,000	2,000	2,200	2,200
15-L	1,800	1,800			
16-S		2,200	1,450	1,450	
18-L	2,000	2,000	2,000		
20-S			3,300	3,500	
22-L		3,100	3,100		
25-S				4,000	4,000
28-L		3,500	3,500		

Table U14 — Pre-Setting Pressures for EO Fittings

2) EO and EO-2 pre-setting dies are not positive stop style. Pre-setting must be done using pressures given in these charts.

Hyferset Pre-Setting Pressures for EO-2 Steel Fittings²⁾

Hyferset Pre-Setting Pressures (psi) for EO-2 Fittings		
Size	Series	Any wall
6	L	1,150
6	S	1,150
8	L	1,450
8	S	1,450
10	L	2,450
10	S	2,450
12	L	2,800
12	S	2,800
14	S	3,500
15	L	2,800
16	S	3,900
18	L	3,200
20	S	5,600
22	L	4,950
25	S	6,400
28	L	5,600

Table U15 — Pre-Setting Pressures for EO-2 Fittings

2) EO and EO-2 pre-setting dies are not positive stop style. Pre-setting must be done using pressures given in these charts.

Dimensions and pressures for reference only, subject to change.





Hydra-Tool

Recommended Flaring Pressures For Metric Tube

Size (mm)	Material	Tube Wall Thickness					Min. Straight Length to Start of Bend
		1.0	1.5	2.0	2.5	3.0	
6	SS	400	700	1100			1-5/8
	Steel	300	500	800			
	Copper	150	200	350			
	Aluminum	150	200	350			
8	SS	500	800	1300			1-5/8
	Steel	400	600	1000			
	Copper	150	250	400			
	Aluminum	150	250	400			
10	SS	600	900	1500			1-5/8
	Steel	500	700	1100			
	Copper	200	300	500			
	Aluminum	200	300	500			
12	SS	800	1200	2000	2500		2-3/16
	Steel	600	900	1500	1900		
	Copper	250	350	600	750		
	Aluminum	250	350	600	750		
16	SS	900	2000	2500	2800	3000	2-5/16
	Steel	680	1500	1900	2100	2300	
	Copper	275	600	750	800	900	
	Aluminum	275	600	750	800	900	
18	SS	1000	1700	2500	3100	3500	2-5/16
	Steel	750	1300	1900	2300	2700	
	Copper	300	500	750	900	1100	
	Aluminum	300	500	750	900	1100	
20	SS		1500	2400	3000	3400	2-7/16
	Steel		1100	1800	2300	2600	
	Copper		500	700	900	1000	
	Aluminum		500	700	900	1000	
25	SS			2400	3000	3400	2-7/16
	Steel			1800	2300	2600	
	Copper			700	900	1000	
	Aluminum			700	900	1000	
30	SS			2800	3400	4000	2-1/2
	Steel			2100	2600	3000	
	Copper			800	1000	1200	
	Aluminum			800	1000	1200	
32	SS				4000	4500	2-7/8
	Steel				3000	3400	
	Copper				1200	1300	
	Aluminum				1200	1300	
38	SS				4500	5800	2-7/8
	Steel				3400	4400	
	Copper				1300	1700	
	Aluminum				1300	1700	
42	SS				4700	6500	2-7/8
	Steel				3600	5200	
	Copper				1500	1900	
	Aluminum				1500	1900	
50	SS				5200	7200	2-7/8
	Steel				3900	6100	
	Copper				1900	2300	
	Aluminum				1900	2300	

Table U16 — Recommended Flaring Pressures, Metric Tube

Dimensions and pressures for reference only, subject to change.





Hydra-Tool

Recommended Flaring Pressures For Inch Tube

Size	Material	Tube Wall Thickness								Minimum Straight Length To Start of Bend
		0.035	0.049	0.065	0.083	0.095	0.109	0.120	0.134	
4	SS	400	700	1100						1-5/8
	Steel	300	500	800						
	Copper	150	200	350						
	Aluminum	150	200	350						
5	SS	500	800	1300						1-5/8
	Steel	400	600	1000						
	Copper	150	250	400						
	Aluminum	150	250	400						
6	SS	600	900	1500						1-5/8
	Steel	500	700	1100						
	Copper	200	300	500						
	Aluminum	200	300	500						
8	SS	800	1200	2000	2500					2-3/16
	Steel	600	900	1500	1900					
	Copper	250	350	600	750					
	Aluminum	250	350	600	750					
10	SS	900	2000	2500	2800	3000				2-5/16
	Steel	680	1500	1900	2100	2300				
	Copper	275	600	750	800	900				
	Aluminum	275	600	750	800	900				
12	SS	1000	1700	2500	3100	3500	4000			2-5/16
	Steel	750	1300	1900	2300	2700	3000			
	Copper	300	500	750	900	1100	1200			
	Aluminum	300	500	750	900	1100	1200			
14	SS		1500	2400	3000	3400	4200			2-7/16
	Steel		1100	1800	2300	2600	3200			
	Copper		500	700	900	1000	1300			
	Aluminum		500	700	900	1000	1300			
16	SS			2400	3000	3400	4200	4800		2-7/16
	Steel			1800	2300	2600	3200	3600		
	Copper			700	900	1000	1300	1400		
	Aluminum			700	900	1000	1300	1400		
20	SS			2800	3400	4000	4800	5300		2-1/2
	Steel			2100	2600	3000	3600	4000		
	Copper			800	1000	1200	1400	1600		
	Aluminum			800	1000	1200	1400	1600		
24	SS				4000	4500	5300	5800		2-7/8
	Steel				3000	3400	4000	4400		
	Copper				1200	1300	1600	1700		
	Aluminum				1200	1300	1600	1700		
32	SS					3300	4000	5000	6300	3
	Steel					2500	3000	3800	4700	
	Copper					1000	1200	1500	1900	
	Aluminum					1000	1200	1500	1900	

Table U17 — Recommended Flaring Pressures, Inch Tube

Note: If tube size and wall thickness are not shown on this chart, see page U3, Table U3 for recommended tube size for use with 37° flare fittings.

Dimensions and pressures for reference only, subject to change.



Recommended Use of Porting Tools

Parker offers porting tools for machining precision ports (glands) conforming to DIN 3852-1, SAE J1926-1 (SAE straight thread port) and the new world standard port, ISO 6149-1.

Machining ports to accept Parker tube fittings is completed in three simple steps.

To begin, select the appropriate size port tooling for the fitting end in question. Next, follow these machining steps.

1. Pilot Hole Drilling.

First, make a pilot hole for the counterbore by using a drill or bore size found in the counterbore tooling tables. Make hole depth according to the port detail on pages T32, T33 and T36. Parker Tube Fittings Division does not sell tap drills or bore tooling.

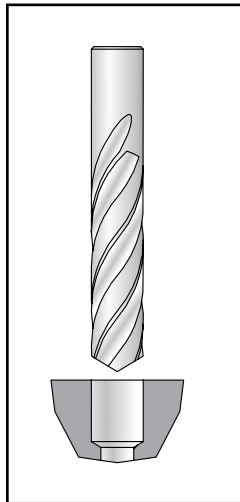


Fig. U1 — Pilot drilling for counterbore tool

2. Port Counterboring.

Then, run the counterbore tool into the pilot diameter created in step 1. All features and dimensions of the port and O-ring cavity are built into the counterboring tool except the depth. The depth of the counterbore machining may vary from a light spotface, up to the maximum spotface depth listed on the port detail on pages U7 and U8.

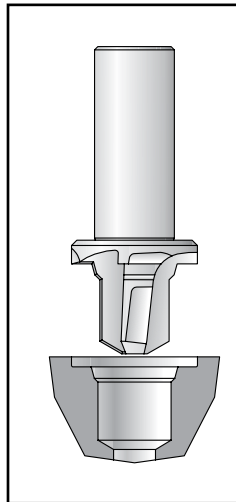


Fig. U2 — Counterboring tool

3. Thread Tapping.

Lastly, the machined port must be threaded to accommodate the fitting. Use the appropriate Parker tapping tool or another tap intended for the same thread type, size, and class.

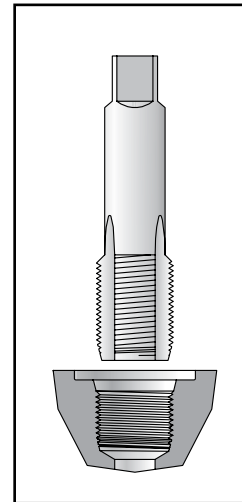


Fig. U3 — Tapping

Note: It is necessary to create a spotface surface which is flat and perpendicular to the port, and with a smooth finish to prevent leakage or O-ring extrusion. Cast or forged surfaces must be spotface machined to meet these requirements. Even on smooth surfaces (machined surfaces), it is necessary to lightly touch the surface to assure a smooth radius at the entrance of the port.

Applicable Standards For TFD Products by Standard Number

ASTM A269	Seamless and welded type 316 Stainless Steel tubing	NFPA T3.8.3 ²⁾	Test methods for steel separable tube fittings
ASTM B633	Zinc plating	SAE J343	Tests and procedures for hose and hose assemblies (impulse test applies to fittings)
ASTM F1387	Mechanically attached fittings — Triple-Lok, Ferulok and Seal-Lok	SAE J356	Welded and flash controlled low carbon steel tubing
DIN 2353	24° cone compression (bite-type) fitting range (configurations)	SAE J512	Automotive tube fittings - 45° flare type - Inverted flare type - Tapered sleeve compression type
DIN 3852-1	Metric parallel thread port (ISO 9974-1)	SAE J514	Hydraulic tube fittings - 37° flare (Triple-Lok) - Flareless – 24° bite type (Ferulok) - O-ring plugs - Pipe fittings - Adapter unions (pipe swivel – “07” adapters)
DIN 3852-2	BSPP parallel thread port (ISO 1179-1)	SAE J515	Hydraulic O-rings (SAE straight thread, face seal, four-bolt split flange, and metric O-ring port)
DIN 3852-3	Metric O-ring port (ISO 6149-1)	SAE J518	Code 61 and 62 four-bolt split flange connections – (same as ISO 6162 Type II flange connection)
DIN 3861	24° cone machining and sleeve for compression (bite-type) fittings	SAE J524	Seamless low carbon steel tubing
DIN 3865	24° cone nipple with O-ring	SAE J525	Welded and cold drawn low carbon steel tubing
DIN 3859	Technical delivery conditions for compression fittings	SAE J527	Brazed double wall steel tubing
DIN 1630	Seamless steel tube	SAE J528	Seamless copper tube
DIN 2391	Seamless precision steel tubes	SAE J531	Automotive pipe, filler and drain plugs (HP and HHP plugs)
DIN 17458	Stainless steel tubes	SAE J533	Flares for tubing – 37° and 45° single and double flares
ISO 1179	BSPP, flat face port and stud ends – same as DIN 3852 - Part 2	SAE J846	Coding system for identification of fluid connectors
ISO 3304	Seamless precision steel tubes	SAE J1065	Pressure ratings for hydraulic tubing
ISO 3305	Welded precision steel tubes	SAE J1231	Beaded tube hose fittings
ISO 6149	Metric straight thread O-ring port and stud ends – same as SAE J2244 and DIN 3852, Part 3	SAE J1453	O-ring face seal fitting with SAE port end – (Seal-Lok)
ISO 6162	Four bolt split flange connections – inch and metric bolts (inch bolt, Part II – same as SAE J518)	SAE J1644	Test methods for fluid connectors
ISO 8434-1	24° cone bite type fittings (EO fittings)	SAE J1926	SAE straight thread O-ring port and stud ends – same as ISO 11926
ISO 8434-2	Metric 37° flare fittings (Metric Triple-Lok)	SAE J2244	Metric straight thread O-ring port and stud ends – same as ISO 6149
ISO 8434-3	Metric face seal fitting with ISO 6149 port end – (Metric Seal-Lok)	SAE J2435	Welded and flash controlled C-1021 tubing
ISO 8434-4	24° cone bite type fittings with weld nipple (EO Fittings)	SAE J2467	Welded and cold drawn, C-1021 tubing
ISO 19879	Test methods for threaded fluid connectors	SAE J2613	Welded and flash controlled high strength low alloy (HSLA) tubing
ISO 8434-6	60° cone connectors with BSPP threads	SAE J2614	Welded and cold drawn HSLA tubing
ISO 9974	Metric flat face port and stud ends – same as DIN 3852 - Part 1		
JIS B8363	60° cone (male and female) hose adapters		
MIL-16142	UN/UNF straight thread O-ring port – same as SAE J1926-1		
MIL-F-18866	37° flare and flareless tube fittings – Triple-Lok and Ferulok (dimensionally similar to SAE J514)		
MIL-33649	Straight thread O-ring port – different from SAE J1926-1		

Table U18 — Applicable Standards by Standard Number

Thread Designations and Standards for Threads Used in Fluid Connectors

Abbreviation	Description	Applicable Std.
Straight Pipe		
NPSC	American Standard Straight Pipe Threads in Pipe Couplings Couplings	ANSI B1.20.1 FED-STD-H28/7
NPSF	Dryseal American Standard Fuel Internal Straight Pipe Threads (generally used in soft or ductile materials to mate with NPTF external taper threads)	SAE J476 ANSI B1.20.3 FED-STD-H28/8
NPSI	Dryseal American Intermediate Internal Straight Pipe Threads (for brittle or hard materials; intended to mate with PTF-SAE short external taper threads)	SAE J476 ANSI B1.20.3 FED-STD-H28/8
NPSM	American Standard Straight Pipe Threads for Free-Fitting Mechanical Joints for Fixtures (these threads fit freely over NPTF threads. They are used in swivel nuts of 07 adapters)	ANSI B1.20.1 FED-STD-H28/7
Taper Pipe		
ANPT	Aeronautical National Taper Pipe Threads (similar to NPT with various additional requirements in gaging)	MIL-P-7105
NPT	American Standard Taper Pipe Threads for General Use	ANSI B1.20.1 FED-STD-H28/7
NPTF	Dryseal American Standard Taper Pipe Threads (used in all of our steel and brass fittings)	SAE J476 ANSI B1.20.3 FED-STD-H28/8
PTF — SAE Short	Dryseal SAE Short Taper Pipe Threads (mainly used in low pressure pneumatic and fuel applications)	SAE J476 ANSI B1.20.3 FED-STD-H28/8
PTF — SPL Short ¹⁾	Dryseal Special Short Taper Pipe Threads	ANSI B1.20.3
PTF — SPL Extra Short ¹⁾	Dryseal Special Extra Short Taper Pipe Threads	ANSI B1.20.3
Unified Threads		
UN	Unified Constant Pitch Threads (standard series: 4, 6, 8, 12, 16, 20, 28, 32)	ANSI B1.1 FED-STD-H28/2
UNC	Unified Coarse Threads	ANSI B1.1 FED-STD-H28/2
UNEF	Unified Extra Fine Threads	ANSI B1.1 FED-STD-H28/2
UNF	Unified Fine Threads	ANSI B1.1 FED-STD-H28/2
UNS	Unified Special Pitch Threads	ANSI B1.1 FED-STD-H28/3
UNJ	Unified Controlled Root Radius Threads	ANSI B1.15 FED-STD-H28/4

Table U19 — Thread Designations and Standards for Threads Used in Fluid Connectors (continued on the next page)

1) Used in some pneumatic components where shortened thread depth is required because of lack of enough material due to component size limitations.



Thread Designations and Standards for Threads Used in Fluid Connectors (Continued)

Abbreviation	Description	Applicable Std.
Metric Threads		
M	Metric Screw Threads — M profile	ISO 261 ANSI B1.13M FED-STD-H28/21
M — Keg	Metric Taper Threads (mainly used in Germany)	DIN 158
British Standard Pipe Threads		
R (BSPT)	British Standard Taper Pipe Threads, External	BS 21 ISO 7/1
Rc (BSPT)	British Standard Taper Pipe Threads, Internal	BS 21 ISO 7/1
Rp or G (BSPP)	British Standard Pipe (Parallel) Threads	BS 2779 ISO 228/1
Japanese Standard Pipe Threads		
PF ¹⁾	JIS Parallel Pipe Threads	JIS B202 ISO 228/1
PT ¹⁾	JIS Taper Pipe Threads	JIS B203 ISO 7/1
PS	JIS Parallel Internal Pipe Threads (to mate with PT threads)	JIS B203

Table U19 (Cont'd) — Thread Designations and Standards for Threads Used in Fluid Connectors

1) PF and PT threads are functionally interchangeable with BSPP and BSPT threads, respectively. These are old designations. They are being replaced with G (for PF) and R and Rc (for PT) as documents are revised.

Document Sources for Connector Specifications

<p>ANSI American National Standards Institute 11 West 42nd Street, 13th Floor New York, New York 10036-8002 Phone: 212-642-4900 Fax: 212-398-0023 www.ansi.org/public/std_info.html</p>	<p>FED-STD Federal Standard Department of Defense Single Stock Point Commanding Officer Naval Publications and Forms Center 5801 Taber Avenue Philadelphia, PA 19120-5099</p>
<p>BSI British Standards Institution 389 Chiswick High Road London, W4 4AL United Kingdom Phone: 44-181-996-9000 Fax: 44-181-996-7400 www.bsi.org.uk/bsis/index.htm</p> <p>British Standards are also available from ANSI</p>	<p>ISO International Organization for Standardization Case Postale 56 I, Rue de Varembe CH - 1211 Geneve 20 Switzerland www.iso.ch/infoe/catinfo.html</p> <p>ISO Documents are also available from ANSI</p>
<p>DIN Deutsches Institut Fur Normung (German Institute for Standards) Burggrafenstrasse 6 Postfach 1107 D - 1000 Berlin 30, Germany www.beuth.de/beuth.htm/?datenbanken</p> <p>English translations of some German Standards can be obtained from:</p> <p>ANSI — or — Global Engineering Documents 15 Inverness Way East Englewood, CO 80112-9660 Phone: 1-800-854-7179</p>	<p>JIS Japanese Industrial Standards Published by Japanese Standards Association 1-24 Akasaka 4 Minto-ku, Tokyo 107-8440 Japan Phone: 81-3-3583-8000 Fax: 81-3-3586-2014</p> <p>English translations of some Japanese Standards can be obtained from ANSI</p> <p>SAE SAE International 400 Commonwealth Drive Warrendale, PA 15096-0001 Phone: 412-776-4841 Fax: 412-776-0002 www.sae.org/prodserv/stds/stdsinfo/standard.html</p>



TABLE
OF
CONTENTS

SI Prefixes		
Prefix	SI Symbol	Multiplication Factor
tera	T	10 ¹²
giga	G	10 ⁹
mega	M	10 ⁶
kilo	k	10 ³
hecto	h	10 ²
deka	da	10 ¹
deci	d	10 ⁻¹
centi	c	10 ⁻²
milli	m	10 ⁻³
micro	μ	10 ⁻⁶
nano	n	10 ⁻⁹
pico	p	10 ⁻¹²
femto	f	10 ⁻¹⁵
atto	a	10 ⁻¹⁸

Table U20 — SI Prefixes

Derived Units			
Quantity	Unit	SI Symbol	Formula
Acceleration	Meter per Second Squared	—	m/s ²
Angular Velocity	Radian per Second	—	rad/s
Area	Square Meter	—	m ²
Density	Kilogram per Cubic Meter	—	kg/m ³
Electric Resistance	Ohm	W	V/A
Energy & Work	Joule	J	N.m
Force	Newton	N	kg.m/s ²
Frequency	Hertz	Hz	cycles/s
Power	Watt	W	J/s
Pressure & Stress	Pascal	Pa	N/m ²
Quantity of Heat	Joule	J	N.m
Specific Heat	Joule per Kilogram-Kelvin	—	J/kg.K
Thermal Conductivity	Watt per Meter-Kelvin	—	W/m.K
Velocity	Meter per second	—	m/s
Viscosity, Dynamic	Pascal Second	—	Pa.s
Viscosity, Kinematic	Square Meter per Second	—	m ² /s
Voltage	Volt	V	W/A
Volume	Cubic Meter	—	m ³

Table U21 — Derived Units

Basic Units		
Quantity	Unit	SI Symbol
Length	Meter	m
Mass	Kilogram	kg
Time	Second	s
Electric Current	Ampere	A
Thermodynamic Temperature	Kelvin	K
Amount of Substance	Mole	mol
Luminous Intensity	Candela	cd

Table U22 — Basic Units

Supplementary Units		
Quantity	Unit	SI Symbol
Plane Angle	Radian	rad
Solid Angle	Steradian	sr

Table U23 — Supplementary Units

U

Dimensions and pressures for reference only, subject to change.



	English to Metric			Metric to English		
	To Convert From	To	Multiply By	To Convert From	To	Multiply By
Area	sq. in. (in ²)	sq. mm (mm ²)	645.16	square millimeters (mm ²)	square inches (in ²)	0.00155
	sq. in. (in ²)	sq. cm (cm ²)	6.4516			
	sq. ft. (ft ²)	sq. meters (m ²)	0.0929			
Density	pounds/cubic ft (lb/ft ³)	Kilograms/cubic meter (kg/m ³)	16.02	kilograms/cubic meter (kg/m ³)	pounds/cubic ft (lb/ft ³)	0.0624
	British thermal units (Btu) (1 J = VVs = 0.2388 cal)	joules (J)	1055	joules (J)	British thermal units (Btu)	0.000947
Force	pounds - force (lbf) (1N = 0.102 kgf)	newtons (N)	4.448	newtons (N)	pounds - force (lbf)	0.2248
	inches (in)	millimeters (mm)	25.4	millimeters (mm)	inches (in)	0.03937
Length	feet (ft)	meters (m)	0.3048	meters (m)	feet (ft)	3.281
	miles (mi)	kilometers (km)	1.609	kilometers (km)	miles (mi)	0.621
	ounces (oz)	grams (g)	28.35	grams (g)	ounces (oz)	0.035
Mass (Weight)	pounds-mass (lb)	kilograms (kg)	0.4536	kilograms (kg)	pounds-mass (lb)	2.205
	short tons (2000 lb) (tn)	metric tons (1000 kg) (t)	0.9072	metric tons (1000 kg) (t)	short tons (2000 lb) (tn)	1.102
	horsepower (550 ft. lb/s) (hp)	kilowatts (kW)	0.7457	kilowatts (kW)	horsepower (550 ft. lb/s) (hp)	1.341
Pressure	pounds/square inch (psi)	kilograms (f)/square cm (kg (f)/cm ²)	0.0703	kilograms (f)/square cm (kg (f)/cm ²)	pounds/square inch (psi)	14.22
	pounds/square inch (psi)	kilopascals (kPa)	6.8948	kilopascals (kPa)	pounds/square inch (psi)	0.145
	pounds/square inch (psi)	bars (100 kPa)	0.06895	bars (100 kPa)	pounds/square inch (psi)	14.503
Stress	pounds/square inch (psi) (1 N/mm ² = 1 MPa)	megapascals (MPa)	0.006895	megapascals (MPa) (1 N/mm ² = 1 MPa)	pounds/square inch (psi)	145.039
	degrees fahrenheit (°F)	degrees celsius (°C)	5/9 (after subtracting 32)	degrees celsius (°C)	degrees fahrenheit (°F)	9/5 (then add 32)
Torque or Bending Moment	pounds-force-foot (lb-ft)	Newtons-meter (Nm)	1.3567	Newtons-meter (Nm)	pounds-force-foot (lb-ft)	0.737
	pounds-force-inch (lb-in)	Newtons-meter (Nm)	0.113	Newtons-meter (Nm)	pounds-force-inch (lb-in)	8.85
Velocity	feet/second (ft/s)	meters/second (m/s)	0.3048	meters/second (m/s)	feet/second (ft/s)	3.2808
	dynamic (centipoise)	pascal-second (Pas)	0.001	pascal-second (Pas)	dynamic (centipoise)	1000
Viscosity	kinematic-foot ² /sec (ft ² /s)	meter ² /sec (m ² /s)	0.0929	meter ² /sec (m ² /s)	foot ² /sec (ft ² /s)	10.7643
	cubic inch (in ³)	cubic centimeter (cm ³) (milliliter)	16.3871	cubic centimeter (cm ³) (milliliter)	cubic inch (in ³)	0.061
Volume	quarts (qt)	liters (1000 cm ³)	0.9464	liters (1000 cm ³)	quarts (qt)	1.057
	gallons (gal)	liters	3.7854	liters	gallons (gal)	0.2642

Table U23 — English to Metric and Metric to English Conversions

Dimensions and pressures for reference only, subject to change.



Glossary of Key Tube Fittings, Fluid Power and Other Engineering Terms

Alloy: A substance having metallic properties and composed of two or more chemical elements of which at least one is a metal.

Annealing: Heat treating process used primarily to soften metals or to stabilize their structures.

Boss: A relatively short protrusion or projection from the surface of a forging or casting, often cylindrical in shape.

Brass: An alloy consisting mainly of copper (over 50%) and zinc, to which smaller amounts of other elements may be added.

Braze 505: Braze 505 is a trademark of the Handy & Harman Company.

Brazing: The joining of metals through the use of heat and capillary flow of a filler metal. The filler metal having a melting temperature above 840 degrees Fahrenheit, but below the melting point of the metals being joined.

Bright Annealing: Annealing in a protective atmosphere to prevent discoloration of the bright surface.

Brinell Hardness Test: A test for determining the hardness of a material by forcing a hard steel or carbide ball of specified diameter into it under a specified load.

Brittle Fracture: A fracture which is accompanied by little or no plastic deformation.

Brittleness: The quality of a material that leads to crack propagation without appreciable plastic deformation.

Bulk Modulus: The measure of resistance to compressibility of a fluid. It is the reciprocal of the compressibility.

Burnishing: Smoothing surfaces of a work piece through frictional contact between it and some hardened tooling.

Carbonitriding: A case hardening process of suitable ferrous material that is effected by the simultaneous absorption of nitrogen and carbon into the surface of the work piece, by heating above the lower transformation temperature in a suitable gaseous atmosphere.

Cavitation: A localized gaseous condition within a liquid stream which occurs when the pressure is reduced to the vapor pressure. Generally occurs in pumps and suction lines where fluid velocity is too high due to poorly sized (too small) line size.

Chatter: The undesirable wavy surface on a machined surface, produced by vibration of the tool, grinding wheel or work piece itself during machining or grinding.

Chromate Treatment: A treatment of metal in a solution of a hexavalent chromium compound to produce a conversion coating of chromium compounds on the surface of the metal, thus improving the resistance to corrosion.

Cold Heading: Working metal at room temperature in such a manner that the cross-sectional area of a portion or all of the stock is increased.

Cold Working (Cold Forming): Permanently deforming metal, usually at room temperature, by the application of an external force in order to produce a near net shape component.

Compressibility: The change in volume of a unit volume of a fluid when subjected to a unit change in pressure.

Corrosion: The deterioration of a metal by chemical or electro-chemical reaction with its environment.

Creep: Time dependent strain occurring under stress. This phenomenon may result in relaxation i.e. the relief of pre-load/pre-stress in assembled components.

Crimping: A swaging and squeezing operation usually used to secure components, such as, nuts and shells to their mating parts.

Deburring: Removing burrs, sharp edges or fins from metal parts usually by filing, grinding or tumbling the work in a barrel containing suitable liquid medium and abrasives.

Density: Ratio of the mass of an object (including fluids) to its volume.

Diamond Pyramid Hardness Test (DPH): An indentation hardness test employing a 136° diamond pyramid indenter and variable loads.

Ductility: The ability of a metal to deform plastically (permanently) without fracturing.

Dynamic Pressure Rating: See PRESSURE, RATED DYNAMIC.

Easy Flo 45: Easy Flo 45 is a trademark of the Handy & Harman Company.

Elastic Deformation: Change of dimensions accompanying stress in the elastic range, original dimensions being restored upon release of stress.

Elastomer: Often referred to as rubber, is a high polymer that can be, or has been modified to a state exhibiting little plastic flow and quick recovery from an extending force.

Erosion: Destruction of metals or other materials by the abrasive action of moving fluids, or particles.

Extrusion: Conversion of an ingot slug or billet into lengths of uniform cross section by plastically forcing the metal through a die orifice having the desired cross sectional profile.

Fatigue/Endurance Limit: The maximum stress below which a material can presumably endure an infinite number of stress cycles.

Fatigue Fracture: The initiation of minute cracks, propagating into ultimate fracture under the application of repeated or fluctuating stresses having a maximum value less than the tensile strength of the material.

Ferrous Metal: A metal in which the major constituent is iron.

Fire Point: The temperature to which a fluid must be heated to *ignite* and *burn* for at least five seconds in the presence of air when a small flame is applied.



Fitting: A connector or closure for fluid power lines and passages.

Flare Test: A test applied to tubing, involving a tapered expansion over a cone, in order to verify tube ductility and resistance to cracking during flaring operation.

Flaring: Forming an outward acute-angle flange on a tubular part.

Flash Point: The temperature to which a liquid must be heated to form a mixture with air that can be ignited *momentarily* by a flame.

Flow: Movement of fluid generated by pressure differences.

Flow, Laminar: A flow situation in which fluid moves in parallel lamina or streamlined layers.

Flow Lines: A fiber pattern, frequently observed in wrought metal, which indicates the manner in which the metal flowed during forming.

Flow Rate: The volume, mass or weight of a fluid passing through any conductor per unit of time.

Flow, Turbulent: A flow situation in which the fluid particles move in a random fluctuation manner. This is generally caused by too high fluid velocity.

Fluid Friction: Friction due to the viscosity of the fluid.

Fluid Power System: A system that transmits and controls power through the use of a pressurized fluid within an enclosed circuit.

Fluorocarbon Rubber: An elastomeric material which is extensively used for O-ring. Fluorocarbon (Viton) is recommended for higher temperatures than nitrile (Buna N) material.

Flux: In brazing, cutting, soldering or welding, material used to dissolve or facilitate the removal of oxides and other undesirable substances.

Folds: Defects in metals, usually on or near the surface caused by continued fabrication of overlapping surfaces.

Forgeability: Term used to describe the relative ability of materials to deform without rupture.

Forging: Plastically deforming metal, usually hot, into desired shapes with compressive force, with or without dies.

Forging Die: A forging whose shape is determined by impressions in specially prepared dies.

Free Machining: Denotes the machining characteristics of an alloy to which one or more ingredients have been introduced to produce small broken chips, lower power consumption, better surface finish and longer tool life.

Galling: Localized welding on mating surfaces of metal parts caused from excessive friction developed during the rubbing action that occurs during assembly.

Galvanic Corrosion: Corrosion resulting from the placing of two dissimilar metals in direct contact with each other then exposing them to an incompatible fluid or atmosphere.

Hammer, Liquid: Pressure and depression waves created by relatively rapid flow changes and transmitted through the system.

Handy Flux: Handy Flux is a trademark of the Handy & Harman Company.

Hardening: Increasing the hardness of a material by suitable treatment, usually involving heating and rapid cooling.

Hardness: Resistance of a material to scratching, abrasion, cutting or deformation.

Head, Pressure: The pressure due to the height of a column or body of fluid.

Heading: See COLD HEADING.

Hot Finishing/Hot Forming: A deformation operation performed at elevated temperature, usually above the recrystallization temperature of the metal.

Hydraulic Power: Power derived from flow rate and pressure differential of the fluid.

Hydraulics: Engineering science pertaining to liquid pressure and flow.

Hydrogen Embrittlement: A condition of low ductility in metals resulting from the absorption of hydrogen.

Hydropneumatics: Engineering science pertaining to the combination of hydraulic and pneumatic fluid power.

Impact Test: A single blow to determine the behavior of materials when subjected to high rates of loading, usually sudden and in the bending, tension or torsion mode. Charpy or Izod tests are typically used to measure materials' impact energy characteristics.

Inclusions: Nonmetallic materials in solid metallic matrix.

Intergranular Corrosion: A preferential corrosive attack at the grain boundaries of a metal.

LB2000: Registered Trademark of ITW.

Lubricant: Any substance used to reduce friction between two surfaces which are in contact.

MPG 2: Registered Trademark of Dubois Chemical Inc.

Machinability: The relative ease of machining a metal.

Machining: Removing material, in the form of chips, from work, usually through the use of a machine.

Malleability: The characteristic of metals that permits plastic deformation in compression without rupture.

Mandrel: (1) A metal bar around which other metal may be cast bent, formed, or shaped. (2) A rod used to retain the cavity in hollow metal products during working.

Mechanical Properties: The properties of a material that reveal its elastic and inelastic behavior under the application of force, thus indicating the material's suitability for mechanical applications. Examples of such properties are: tensile strength, elongation, modulus of elasticity, yield strength, reduction in area and fatigue limit.

Microhardness: The hardness of microscopic areas or of the individual microconstituents in a metal.

Microstructure: The structure of polished and etched metals as revealed by a microscope at a magnification greater than ten diameters.

Mild Steel: Carbon steel with a maximum of .25 percent carbon.

Nitriding: A case hardening process conducted by the introduction of nitrogen into the surface of a solid ferrous alloy.

Nitrile (Buna N): A copolymer of butadiene and acrylonitrile. It is the elastomer most widely used to manufacture O-rings.

Nondestructive: Inspection or test by methods that do not destroy the part.

O-ring: A torus, or doughnut shaped object, generally made from elastomer and is used primarily for sealing.

Passivation: A process used to improve corrosive behavior of a metal by changing its chemically active surface to a much less reactive state.

Pipe: (1) The defect in wrought or cast products resulting from the central cavity formed by contraction in metal, especially ingots, during solidification. (2) A tubular metal product that includes iron pipe size (I.P.S.) and schedule number in its classification.

Pipe Thread, Dry Seal: Tapered pipe threads in which sealing is a function of root and crest interference.

Pitting: Forming small sharp cavities in a metal surface by corrosion, mechanical action or nonuniform electrodeposition.

Plastic Deformation: Deformation that does or will remain permanent in an element after removal of the stress that caused it.

Pneumatics: Engineering science pertaining to gaseous pressure and flow.

Port: A terminus of a passage in a component to which conductors can be connected.

Port, Pipe: A port which conforms to pipe thread standards.

Port, Straight Thread: A port which conforms to straight thread standards. It typically employs an O-ring compressed in a wedge-shaped cavity.

Power Supply, Fluid: Energy source which generates and maintains a flow of fluid under pressure.

Precipitation Hardening: Hardening caused by the precipitation of a constituent from a supersaturated solid solution.

Pressure: Force per unit area, usually expressed in pounds per square inch (psi).

Pressure, Absolute: The pressure above absolute zero, i.e., the sum of atmospheric pressure plus gage pressure.

Pressure, Atmospheric: Pressure exerted by the atmosphere at any specific location. [Sea level atmospheric pressure is approximately 14.7 pounds per square inch (about 1 bar)]

Pressure, Burst: The pressure which causes failure of, and consequential loss of fluid through the product envelope.

Pressure, Cyclic Test: A pressure range applied in cyclic endurance tests that are performed to help determine recommended working pressure.

Pressure, Differential (Pressure Drop): The difference in pressure between any two points of a system or a component.

Pressure, Gage: Pressure differential above or below ambient atmospheric pressure.

Pressure, Nominal: A pressure value assigned to a component or system for the purpose of convenient designation.

Pressure, Operating: See WORKING PRESSURE.

Pressure, Proof: The non-destructive test pressure, in excess of the maximum rated operating pressure, which causes no permanent deformation, external leakage, or other resulting malfunction.

Pressure, Rated Dynamic: The maximum fluctuating pressure load that a pressure containing envelope is capable of sustaining for a minimum of 1 million operating cycles without failure.

Pressure, Rated Static: The maximum pressure that a pressure containing envelope is capable of sustaining in an application not exceeding 30,000 operating cycles in a system free of pressure surges, shocks, vibration, temperature excursions, etc.

Pressure, Relief: The pressure at which the relief valve is set for actuation. This pressure is generally slightly higher than the system working pressure.

Pressure Shock: A pressure wave front which moves at a sonic velocity, due to sudden stoppage of fluid flow.

Pressure, Static: The pressure in a fluid at rest.

Pressure, Surge: The pressure increases resulting from pressure fluctuations in a hydraulic system.

Pressure, Working: The pressure at which the apparatus is being operated in a given application.

Pressure, Working Rated: The qualified operating pressure which is recommended for a system or a component by the manufacturer.

Proof Load: A pre-determined load, generally some multiple of the service load, to which a specimen or structure is submitted before acceptance for use.

Quenching: Rapid cooling method used in heat treating process.

Residual Stress: Stress existing in a body that is free of external forces or thermal gradients.

Rockwell Hardness Test: A test for determining the hardness of a material based upon the depth of penetration of a specified penetrator into the specimen.

Roughness: Relatively finely-spaced surface irregularities, the height, width and direction of which establish the predominant surface pattern.

STP: Distributed by First Brand Corp. Danbury, CT.

Scaling: (1) Forming a thick layer of oxidation products on metals at high temperatures. (2) Depositing water-insoluble constituents on a metal surface, as in cooling tubes and water boilers.

Seam: A fold or lap on the surface of a metal appearing as a crack, usually resulting from a defect obtained in casting or in working.

Segregation: Concentration of alloying elements in specific regions in a metallic object.

Shear Strength: The load divided by the original cross-sectional area of a section separated by a shear force.

Sour Environment: Fluids containing water as a liquid and hydrogen sulfide, and may cause sulfide stress cracking (SSC) of susceptible materials.

Specific Gravity, Liquid: The ratio of the weight of a given volume of liquid to an equal volume of water.

Spot Facing: Machining in the mating component, a flat seat for a bolt head, nut, locknut or other similar element.

Springback: (1) The elastic recovery of metal after stressing. (2) The degree to which metal tends to return to its original shape or contour after undergoing a forming operation.

Stainless Steel: Basically, low carbon alloy steels containing at least 11.5% chromium. These steels are characterized by their high resistance to corrosion.

Static Pressure Rating: See pressure, rated static

Steel: An iron-based alloy, containing: manganese, usually carbon, and often other alloying elements.

Strain: A measure of the relative change in size or shape of a body. Example, linear strain is computed as the ratio of change in length to the original length.

Stress: The result of a force acting on a given surface area. Computed as the ratio of the applied force to the affected area.

Stress Corrosion Cracking (SCC): Fracture in a material resulting from the combined action of applied stress and corrosive environment.

Stress Raisers/Concentration: Changes in contour or discontinuities in structure that cause local increases in stress.

Stringer: In wrought materials, an elongated configuration of microconstituents or foreign material aligned in the direction of working.

Sulfide Stress: Brittle failure by cracking under the combined action of tensile stress and corrosion in the presence of water Cracking (SSC) and hydrogen sulfide.

Surge: A transient rise of pressure or flow.

Swaging: Forming a taper or a reduction on metal products such as rod and tubing by forging, squeezing or hammering.

Temperature, Ambient: The temperature of the environment in which the apparatus is working.

Tensile Strength: In tensile testing, the ratio of maximum load to original cross-sectional area.

Tensile Strength, Ultimate: The maximum stress that a material can withstand.

Torque: Turning effort (moment) applied to a component for fastening, tightening or assembling.

Torsion: A twisting action resulting in shear stresses and strain.

Toughness: Ability of a metal to absorb energy and deform without fracturing.

Tube: Hollow, cylindrical products having outside diameters that are not standardized for threading. Tubes are dimensionally classified in terms of their outside diameters and wall thicknesses.

Upsetting: See COLD HEADING.

Vacuum: Pressure less than ambient atmospheric pressure.

Vibra-Seal: Vibra-Seal is a registered trademark of Loctite Corporation.

Viscosity: A measure of the internal friction or the resistance of a fluid to flow.

Viton: Viton is a registered trademark of E.I. Du Pont de Nemours and Company.

Welding: Joining two or more pieces of metal by applying heat, pressure or both with or without filler metal, to produce a localized union through fusion or recrystallization across the interface.

Work Hardening: An increase in hardness and strength caused by plastic deformation at temperatures lower than the recrystallization range. (Same as Strain Hardening. See also, Cold Working.)

Working Pressure, Dynamic: See PRESSURE, RATED DYNAMIC.

Working Pressure, Static: See PRESSURE, RATED STATIC.

Yield Strength: The maximum stress that can be applied to a material, which upon removal, the material will return to approximately its original shape.

Numeric Index

V

Part NumberPage	Part NumberPage	Part NumberPage
- 0 -	AOE4G..... F21	BUVQ1..... L30
0107..... G5	AOEG5..... F21	BV06/1, BV20/25.....R6
0109..... M11	AOEL6 A23	
0207..... G5	AOEX6 B22	- C -
0507..... G5	AOG5JG5 F24	C3MX.....B26
077T G7	APB P11	C3P4..... H7
	APC P8	C3T4..... H5
- 1 -	APDA P5	C4OMLO A26
1' hand tube bender.....R5	APDC..... P8	C4OMX.....B26
157422.....R32	APKA P5	C5BU..... C10
	APLA..... P5	C5OLO A23
- 2 -	APLC P8	C5OX.....B23
2107..... G7	APRA P6	C5OXO B34
210A combination toolR28	APRB P11	C6BU..... C10
217T G8	APWA P6	C6LO A23
2207..... G7	AS..... E23	C6MK4 I8
227T G8	AS3 / AS6 L26	C6MLO A23
2507..... G6	ASA..... P6	C6X.....B22
	ASB P11	C6XO B34
- 3 -	ASC P8	C87OMLO A24
3107..... G6		C87OMX.....B25
3207..... G6	- B -	C8OMLO A25
3507..... G5	B3HQ..... L13	C8OMX.....B25
	BAV06/12.....R6	Captive O-Ring installation
- 4 -	BCP O8	toolR48
412.....R8	BCPH.....O11, O17, O20	CBI2..... D7
424.....R9	BCPT O14	CBU..... C11
	Bender capacity guides.....R7	CC5BU C11
- 5 -	BFG L15	CC5OLO A24
522398.....R18	BFW..... L34	CC5OX B23
550501.....R18	BI2 D5	CC87OMLO.....A25
5507..... G6	BIP D5	CCCTX B24
5607..... G7	BIP O8	CCTX B24
	BL A9	CD F22
- 7 -	BML.....A9	CD45 F20
770106.....R30	Bonded Seal for Banjo Fittings . N8	Clamp Halves - Compact Spiral
	Braze flux.....R49	Hose Heavy Series O16
- 8 -	BSPP Bonded Seal N7	Clamp Halves - Compact Spiral
820029.....R18	BSPP counterbores.....R36	Hose Heavy Twin..... O19
	BSPP O-Ring..... N6	Clamp Halves Heavy Series O10
- 9 -	BSPP/BSPT taps.....R36	Clamp Halves Standard Series . O7
900044..... R25, R29	BTI2 D5	Clamp Halves Twin Series O13
900044.....R41	BTX.....B9	CLO A24
974250.....R21	BU C7	CP..... L29
	BUEQ1..... L31	CP..... O8
- A -	BUHLO K4	CP432 tube & pipe bender kit ..R19
A87LPOEG87LPM..... F23	BUHQ1 L12	CPH.....O11, O17
AOEG..... F21		



Part Number	Page	Part Number	Page	Part Number	Page	
CPHT	O20	EL	E46	F5OX.....	B14	
CPT.....	O14	EL-M-ED.....	E47	F5OXO.....	B33	
CR	F22	ELO.....	A21	F63MX	B19	
CRA	O9, O12, O15, O18, O20	EL-R-ED	E47	F63P4	H6	
CTX.....	B24	EMK4.....	I8	F642EDML.....	A19	
CTXO.....	B34	EMLO	A21	F642EDMX	B19	
Cut-off saw	R21	EO lubricants.....	R50	F65OL.....	A18	
- D -			EO O-Ring.....	N10	F65OX.....	B18
D.....	E13	EO Swivel O-Ring.....	N9	F682EDML.....	A19	
DA.....	E25	EO-2 Sealing Ring.....	N7	F682EDMX	B19	
DBI2.....	D7	EO-Karrymat.....	R46	F687OML.....	A19	
DBU.....	C11	Eolastic Seal Ring.....	N6	F687OMX	B18	
DD	F22	ESV.....	E17	F68OMX	B19	
DD45	F21	ET	E45	F6L	A18	
DG101	E53	ET-M-ED	E46	F6MK4.....	I6	
DG102-M.....	E54	ET-R-ED.....	E45	F6X	B18	
DG102-R	E54	ETX	B21	F82EDMLO.....	A15	
DG103	E53	ETXO	B34	F82EDMX	B16	
DG104-M.....	E55	EW	E34	F82HG8	F17	
DG104-R	E54	EW-M-ED	E35	F87OHG87M	F16	
DG105	E53	EW-R-ED.....	E35	F87OMLO.....	A15	
DG106-M.....	E55	Exactol benders	R8 - R11	F87OMX	B16	
DG106-R	E55	- F -			F8OHA80.....	F12
DG107	E53	F3HG	F20	F8OHG	F16	
DG108	E54	F3HG5	F20	F8OHG5	F16	
DPA.....	P6	F3MK4.....	I7	F8OMX	B16	
DPB	P11	F3MX	B17	FBI2.....	D6	
DPC	P9	F3P4	H6	FBU	C8	
DPDC.....	P9	F3T4	H5	FCC	L9	
DPR	E13	F42EDMLO.....	A15	FCS.....	L9	
DTX.....	B25	F42EDMX	B16	Ferulset ferrule pre-setter.....	R39	
DV	E60	F4OHG	F17	FF	F11	
DVGE-M	E52	F4OHG5	F17	FF33M	F12	
DVWE-M.....	E52	F4OMX	B17	FF5OLO	A14	
DVGE-R.....	E51	F5BU	C8	FF5OX	B14	
DVWE-R	E51	F5OF.....	F11	FFF	F11	
- E -			F5OG.....	F13	FFTX	B15
E	E15	F5OG5.....	F13	FG.....	F15	
E6MK4.....	I9	F5OHAO	F11	FHF3.....	F20	
EBI2.....	D7	F5OHF42.....	F14	FHG4	F15	
EBU	C10	F5OHG4	F14	FHG5	F14	
EGE-M-ED.....	E26	F5OHG8	F14	FHG8	F15	
EGE-NPT	E25	F5OHQ1.....	L13	FHQ4O	L41	
EGEO.....	E26	F5OHQ2	L13	FHS3.....	L10	
EGE-R-ED	E26	F5OHQ4O.....	L42	FHS6.....	L11	
		F5OLO	A14	Flange Seal O-Ring	N10	
				Flanging pin and die sets	R23	





Part NumberPage	Part NumberPage	Part NumberPage
Flaring tooling for Parflange	GBU..... C9	HPC..... F27
ECO25.....R34	GE-M..... E22	HRN..... O9
Flaring tooling for Parflange	GE-M-ED..... E21	HTX.....B10
1025.....R33	GE-NPT..... E18	HTXO.....B33
FLO.....A14	GEO..... E19	HT4..... H5
FM..... E14	GEQ..... L36	HX6.....B17
FMK4..... I7	GE-R..... E20	Hydra-Tool.....R29 - R31
FNI..... D8	GE-R-ED..... E19	Hydra-Tool.....R44
FNL.....A33	GE-UNF/JN..... E18	Hyferset ferrule pre-setterR41
FNLBA..... M10	GFS..... L14	
FNMK4..... I8	GG..... F12	- I -
FNMKA..... J5	GG44M..... F13	In-Ex deburring tool.....R22
FNML.....A33	GHG4..... F17	IPS..... O8
FNMP4..... H7	GHQ / G5HQ..... L16	ISA..... P5
FNMT4..... H5	GHQ40..... L42	ISB..... P10
FNTX.....B32	GLO.....A15	ISC.....P8
FNU..... C14	GLO..... M7	ISO 6149 O-Ring..... N5
FTX..... B15	GM..... E15	ISO 6149-1 port counterbore...R38
FTXO.....B33	GMA3..... M5	ISO 6149-1 port counterbore
	GQ..... L18	with ID grooveR38
- G -	GQ - Stainless Steel..... L38	ISO 6149-1 port tapR37
G..... E16	GQS..... L27	ITK.....R53
G3P4..... H6	GR..... E16	I-TL..... E59
G4MK4..... I7	GTX.....B15	
G4MLOSMO..... M6	GTX..... M7	- J -
G4MX..... B17	GTXO.....B33	J6MK4..... I10
G4MXSMO..... M6	GZ..... E25	JBI2..... D7
G4Q..... L19	GZR..... E25	JBU..... C12
G5EQ..... L35		JIS B2351 O-Ring..... N7
G5G5JAO..... F23	- H -	JLO.....A26
G5G5JG5..... F24	H6MK4..... I6	JMK4..... I9
G5HG5..... F12	Hand tube benders..... R4, R5	JMLO.....A26
G5HQ40..... L42	HB632..... R12 - R16	JTX.....B26
G5LO..... M7	HBI2..... D6	JTXO.....B35
G5Q..... L18	HBU..... C7	JX6.....B28
G5Q - Stainless Steel..... L38	HHP..... F26	
G63P4..... H6	HL6.....A18	- K -
G65L.....A18	HLO.....A12	K..... E50
G65L..... M7	HMK4..... I6	Karryflare.....R32
G6L.....A18	HMKA..... J5	KBI2..... D8
G6L..... M7	HMLO.....A12	KBU..... C14
G6X..... B18	HP..... F26	KH..... E62
G6X..... M7	HP3M..... F28	KH..... E63
G8HG8..... F13	HP4..... H6	KH-R/NPT..... E64
GAI-M..... E23	HP46..... H7	KLO.....A32
GAI-R..... E22	HP5ON..... F26	Kloskut - large.....R21
GBI2..... D6	HPBA..... M10	Kloskut - medium.....R21

Part Number	Page
KMMOO	F25
KTX.....	B32
K4HF8O.....	I7
- L -	
LB 2000 & MPG-2	R50
LD	E60
LEE-M.....	E44
LEE-OR.....	E44
LEE-R	E44
LEE-UNF	E43
LHTX.....	B10
LOEQ1	L31
LOEQ2	L31
LOEX6	K3
LOHB3.....	A16
LOHL6	A18
LOHL6 Orifice.....	M9
LOHL6G5TP	M5
LOHQ1	L12
LOHQ2	L12
LOHQ4O.....	L41
LOHT3	A16
LOHU86.....	K4
LOHX6	K3
LOVQ1	L30
LOVQ2	L30
LP	O8
LPH.....	O11, O17
LPT	O14
- M -	
M	E13
Mandrel bending	
components	R16 - R18
MAV	M6
MAVE.....	M6
MBI2	D8
MBU	C14
Metal Seal for Banjo Fittings	N8
Metric O-Ring.....	N5
Metric Retaining Ring	N5
MMLOHB3	A16
MMO.....	F25
MMO444M	F25
MMS.....	F24
Moduar preparation centers.....	R52

Part Number	Page
MOK38SX.....	R46
MRO	F24
MTX	B30
- N -	
NPTF taps	R37
- O -	
OBI2	D8
OBU.....	C13
O-lube.....	R50
ORFS O-Ring	N4
O-Ring pick	R48
OTX.....	B30
- P -	
P	L15
P47OMN.....	F28
P47OMN.....	H7
P5ON.....	F25
P5ONBA	M10
P87OMN.....	F27
Parflange ECO25.....	R25
Parflange 1025	R23
Par-Lok wrenches	R54 - R55
PNI.....	D8
PNLO	A33
PNLOBA	M10
PNMK4	I8
PNMKA.....	J5
PNMLO.....	A33
PNMP4	H6
PNMT4	H5
PNTX	B32
PNU	C14
Portboards.....	R53
Post braze cleaner.....	R49
Power deburr tool.....	R22
PQ	L28
PQ - Stainless Steel	L40
PQ4O.....	L43
Pre-setting tooling for	
Hydra-Tool.....	R44 - R45
Pressure Gauge Sealing Ring....	N9
PSR	E13
PTR.....	F15
PTR34M.....	F17

Part Number	Page
- Q -	
Q4 Insert.....	L43
QPQPJQ.....	L35
- R -	
R	O9, O15
R4OMLO	A32
R4OMX	B31
R5BU	C13
R5OLO.....	A30
R5OX	B29
R5OXO	B35
R6BU	C12
R6LO	A29
R6MK4.....	I9
R6MLO	A29
R6X.....	B28
R87OMLO	A31
R87OMX.....	B31
Radial Seal O-Ring.....	N10
Ratchet hand tube bender	R4
RB12.....	D7
RBP / RBN.....	P10
RBU	C13
RCP / RCN / RCA / RCPD.....	P7
RED	E24
Retaining Ring	N6
RH	O12, O18, O20
RHD.....	E56
RHDI	E58
RHV-M-ED.....	E57
RHV-R-ED	E56
RHZ-M-ED.....	E58
RHZ-R-ED	E57
RI	F19
RI-ED	F18
RNH.....	O12, O18, O20
RNT	O15
Rolo-Flair rotary, manual	R28
ROV	E50
RRS	F24
RTX.....	B30
RTXO	B35
RVP.....	E59
- S -	
S4OMLO.....	A31





Part Number	Page	Part Number	Page	Part Number	Page
S4OMX	B31	T23UI	D5	V5BU	C9
S5BU	C12	TEE-M.....	E43	V5OLO	A20
S5OLO.....	A29	TEE-OR	E42	V5OX	B20
S5OX	B29	TEE-R	E42	V6LO.....	A20
S6BU	C12	TEE-UNF	E41	V6X	B20
S6LO	A28	TH-M	E48	V87OMLO.....	A20
S6MK4.....	I9	TH-M-KDS.....	E49	V87OMX	B20
S6MLO	A28	TH-R	E48	VB12.....	D6
S6X.....	B28	Thread identification kit	R53	VBU	C9
S87OMLO.....	A30	Threadmate	R51	VDHA.....	E61
S87OMX	B31	TH-R-KDS	E49	VDHB.....	E61
SAE 4-Bolt Flange O-Ring.....	N10	TI2.....	D5	VEE-M	E28
SAE O-Ring	N4	TIP	D5	VEE-OR	E27
SAE straight thread port counterbore	R35	TL (Inch).....	A10	VEE-R	E28
SB.....	O8	TLS (Metric).....	A10	VEE-UNF	E27
SBA	P6	TMA	P6	VH.....	E15
SBB	P11	TMB.....	P11	Vise block and flaring pin.....	R27 - R28
SBH	O11, O17	TMC.....	P9	VKA.....	E50
SBI2.....	D7	TPL (Inch)	A9	VKA3.....	M8
SBR	B10	TPLS (Metric).....	A9	VLO.....	A21
SBR (Inch).....	A11	TR.....	E40	VOMO.....	R40
SBR (Metric)	A11	TR.....	E41	VSTI M-ED.....	F27
SBT.....	O14	TRBI2.....	D6	VSTI M-OR	F27
SBU	C13	TRBU	C9	VSTI R-ED	F28
Seamless stainless steel tubes .	Q6	TRLON.....	A17	VTX	B21
Seamless steel tubes	Q4, Q5	TRTX / TRTXN	B13		
SHP	F26	Tru-Kut.....	R21	- W -	
SKA	E26	TS	P6	W	E29
SLA.....	P5	TS	P11	W4Q	L21
SLO	A30	TSC.....	P9	W5Q	L20
SPC	P9	TU.....	C7	W5Q - Stainless Steel	L39
SPGG5	L29	Tube fabricating equipment weight chart.....	R56 - R57	W5SQS.....	L28
SSB	P10	TX (Inch).....	B9	W6EQ	L37
SSC	P8	TX (metric)	B9	W6Q	L23
SSLA.....	P5			W7EQ	L32
Straight thread port tap	R35	- U -		W7HQ.....	L16
STX.....	B30	UPTC Nut Assembly.....	A34	W7HQ40	L43
Super o-lube.....	R50	USA	P6	W7Q	L22
SV	E17	USC.....	P9	WAS.....	E39
SWVE-M.....	E36			WB1HQ1 / WB3HQ1 / WB5HQ1	L17
SWVE-R.....	E36	- V -		WB1Q1 / WB3Q1 / WB5Q1.....	L24
		V3MX.....	B21	WB3HQ2 / WB5HQ2 / WB7HQ2	L17
- T -		V3P4	H7	WB3Q2 / WB5Q2 / WB7Q2.....	L25
T	E39	V3T4	H5	WBI2.....	D6
T22I.....	D8	V4OMLO.....	A21		
T22X	B32	V4OMX	B21		

Part Number	Page	Part Number	Page
WBT.....	L26	WTX.....	B11
WBU.....	C8	WV.....	E65
WEBU.....	C10		
WEE-M.....	E33	- X -	
WEE-OR.....	E32	X6EF.....	B23
WEE-R.....	E33	XEMK46.....	K6
WEE-UNF.....	E32	XEQ1.....	L31
WELO.....	A22	XEQ2.....	L31
WE-M keg.....	E31	XHB3.....	B14
WEMLO.....	A22	XHBU.....	K4
WE-NPT.....	E30	KHBU2.....	K4
WE-R keg.....	E31	XHK4.....	K5
WETX.....	B22	XHL6.....	K3
WF5OLO.....	A13	XHLO.....	K3
WF5OX.....	B11	XHMK46.....	K5
WFS.....	L33	XHMKA.....	J5
WFTX.....	B11	XHMKA6.....	J5
WGTX.....	B12	XHQ1.....	L12
WH-M.....	E37	XHQ2.....	L12
WH-M-KDS.....	E38	XHQ40.....	L41
WH-R.....	E37	XHT4.....	K5
WH-R-KDS.....	E38	XHT46.....	K5
WJJLO.....	A27	XHU86.....	K6
WJJMLO.....	A28	XHX6.....	B12
WJJTX.....	B27	XHX6G5TP.....	M5
WJLO.....	A26	XHX7 Orifice.....	M9
WJMLO.....	A27	XO O-Ring.....	N4
WJTX.....	B27	XVQ1.....	L30
WLN.....	B10	XVQ2.....	L30
WLN.....	C7		
WLN.....	A11		
WLNML.....	A11		
WLO.....	A12		
WMK4WL4NM.....	I6		
WMLO.....	A13		
WNLO.....	A19		
WNMLO.....	A20		
WNTX.....	B20		
WP.....	O9		
WPE.....	O9		
WPH.....	O11, O17		
WPHT.....	O20		
WPT.....	O15		
WSD.....	L27		
WSV.....	E30		





1/8" 1/4" 3/8"

Male Pipe Thread Sizes

1/2"
3/4"
1"
1-1/4"
1-1/2"
2"

TABLE
OF
CONTENTS

2"
-32

1-1/2"
-24

1-1/4"
-20

1"
-16

7/8"
-14

SAE (JIC) 37° Flare Nose Cone Sizes

5/8" -10 1/2" -8 3/8" -6 1/4" -4

1" -16 7/8" -14 3/4" -12

1-1/2" -24 1-1/4" -20

O-Ring Face Seal (SAE J1453)

Male Pipe Thread Sizes

FITTING END SIZE CHART

SAE (JIC) 37° Flare Nose Cone Sizes

SAE 45° Flare
Nose Cone Sizes

3/4" -12

5/8" -10

1/2" -8

3/8" -6

5/16" -5

1/4" -4

3/4" -12

3/8" -6



Parker Safety Guide for Selecting and Using Hose, Tubing, Fittings, Connectors, Conductors, Valves and Related Accessories

Parker Publication No. 4400-B.1

WARNING: Failure or improper selection or improper use of hose, tubing, fittings, assemblies, valves, connectors, conductors or related accessories (“Products”) can cause death, personal injury and property damage. Possible consequences of failure or improper selection or improper use of these Products include but are not limited to:

- Fittings thrown off at high speed.
- High velocity fluid discharge.
- Explosion or burning of the conveyed fluid.
- Electrocution from high voltage electric powerlines.
- Contact with suddenly moving or falling objects that are controlled by the conveyed fluid.
- Injections by high-pressure fluid discharge.
- Dangerously whipping Hose.
- Tube or pipe burst.
- Weld joint fracture.
- Contact with conveyed fluids that may be hot, cold, toxic or otherwise injurious.
- Sparking or explosion caused by static electricity buildup or other sources of electricity.
- Sparking or explosion while spraying paint or flammable liquids.
- Injuries resulting from inhalation, ingestion or exposure to fluids.

Before selecting or using any of these Products, it is important that you read and follow the instructions below. No product from any division in Parker Fluid Connectors Group is approved for in-flight aerospace applications. For hoses and fittings used in in-flight aerospace applications, please contact Parker Aerospace Group.

1.0 GENERAL INSTRUCTIONS

- 1.1 Scope:** This safety guide provides instructions for selecting and using (including assembling, installing, and maintaining) these Products. For convenience, all rubber and/or thermoplastic products commonly called “hose” or “tubing” are called “Hose” in this safety guide. Metallic tube or pipe are called “tube”. All assemblies made with Hose are called “Hose Assemblies”. All assemblies made with Tube are called “Tube Assemblies”. All products commonly called “fittings”, “couplings” or “adapters” are called “Fittings”. Valves are fluid system components that control the passage of fluid. Related accessories are ancillary devices that enhance or monitor performance including crimping, flaring, flanging, presetting, bending, cutting, deburring, swaging machines, sensors, tags, lockout handles, spring guards and associated tooling. This safety guide is a supplement to and is to be used with the specific Parker publications for the specific Hose, Fittings and Related Accessories that are being considered for use. Parker publications are available at www.parker.com. SAE J1273 (www.sae.org) and ISO 17165-2 (www.ansi.org) also provide recommended practices for hydraulic Hose Assemblies, and should be followed.
- 1.2 Fail-Safe:** Hose, Hose Assemblies, Tube, Tube Assemblies and Fittings can and do fail without warning for many reasons. Design all systems and equipment in a fail-safe mode, so that failure of the Hose, Hose Assembly, Tube, Tube Assembly or Fitting will not endanger persons or property.
- 1.3 Distribution:** Provide a copy of this safety guide to each person responsible for selecting or using Hose, Tube and Fitting products. Do not select or use Parker Hose, Tube or Fittings without thoroughly reading and understanding this safety guide as well as the specific Parker publications for the Products.
- 1.4 User Responsibility:** Due to the wide variety of operating conditions and applications for Hose, Tube and Fittings. Parker does not represent or warrant that any particular Hose, Tube or Fitting is suitable for any specific end use system. This safety guide does not analyze all technical parameters that must be considered in selecting a product. The user, through its own analysis and testing, is solely responsible for:
- Making the final selection of the Products.
 - Assuring that the user’s requirements are met and that the application presents no health or safety hazards.
 - Following the safety guide for Related Accessories and being trained to operate Related Accessories.
 - Providing all appropriate health and safety warnings on the equipment on which the Products are used.
 - Assuring compliance with all applicable government and industry standards.
- 1.5 Additional Questions:** Call the appropriate Parker technical service department if you have any questions or require any additional information. See the Parker publication for the Products being considered or used, or call 1-800-CPARKER, or go to www.parker.com, for telephone numbers of the appropriate technical service department.

2.0 HOSE, TUBE AND FITTINGS SELECTION INSTRUCTIONS

- 2.1 Electrically Nonconductive:** Certain applications require that the Hose be nonconductive to prevent electrical current flow. Other applications require the Hose and the Fittings and the Hose/Fitting interface to be sufficiently conductive to drain off static electricity. Extreme care must be exercised when selecting Hose, Tube and Fittings for these or any other applications in which electrical conductivity or nonconductivity is a factor.
- The electrical conductivity or nonconductivity of Hose, Tube and Fittings is dependent upon many factors and may be susceptible to change. These factors include but are not limited to the various materials used to make the Hose and the Fittings, Fitting finish (some Fitting finishes are electrically conductive while others are nonconductive), manufacturing methods (including moisture control), how the Fittings contact the Hose, age and amount of deterioration or damage or other changes, moisture content of the Hose at any particular time, and other factors.
- The following are considerations for electrically nonconductive and conductive Hose. For other applications consult the individual catalog pages and the appropriate industry or regulatory standards for proper selection.
- 2.1.1 Electrically Nonconductive Hose:** Certain applications require that the Hose be nonconductive to prevent electrical current flow or to maintain electrical isolation. For applications that require Hose to be electrically nonconductive, including but not limited to applications near high voltage electric lines, only special nonconductive Hose can be used. The manufacturer of the equipment in which the nonconductive Hose is to be used must be consulted to be certain that the Hose, Tube and Fittings that are selected are proper for the application. Do not use any Parker Hose or Fittings for any such application requiring nonconductive Hose, including but not limited to applications near high voltage electric lines or dense magnetic fields, unless (i) the application is expressly approved in the Parker technical publication for the product, (ii) the Hose is marked “nonconductive”, and (iii) the manufacturer of the equipment on which the Hose is to be used specifically approves the particular Parker Hose, Tube and Fittings for such use.
- 2.1.2 Electrically Conductive Hose:** Parker manufactures special Hose for certain applications that require electrically conductive Hose. Parker manufactures special Hose for conveying paint in airless paint spraying applications. This Hose is labeled “Electrically Conductive Airless Paint Spray Hose” on its lay-line and packaging. This Hose must be properly connected to the appropriate Parker Fittings and properly grounded in order to dissipate dangerous static charge buildup, which occurs in all airless paint spraying applications. Do not use any other Hose for airless paint spraying, even if electrically conductive. Use of any other Hose or failure to properly connect the Hose can cause a fire or an explosion resulting in death, personal injury, and property damage. All hoses that convey fuels must be grounded.
- Parker manufactures a special Hose for certain compressed natural gas (“CNG”) applications where static electricity buildup may occur. Parker CNG Hose assemblies comply with the requirements of ANSI/IAS NGV 4.2; CSA 12.52, “Hoses for Natural Gas Vehicles and Dispensing Systems” (www.ansi.org). This Hose is labeled “Electrically Conductive for CNG Use”

Parker Safety Guide, Parker Publication No. 4400-B.1 (continued)

on its layline and packaging. This Hose must be properly connected to the appropriate Parker Fittings and properly grounded in order to dissipate dangerous static charge buildup, which occurs in, for example, high velocity CNG dispensing or transfer. Do not use any other Hose for CNG applications where static charge buildup may occur, even if electrically conductive. Use of other Hoses in CNG applications or failure to properly connect or ground this Hose can cause a fire or an explosion resulting in death, personal injury, and property damage. Care must also be taken to protect against CNG permeation through the Hose wall. See section 2.6, Permeation, for more information. Parker CNG Hose is intended for dispenser and vehicle use within the specified temperature range. Parker CNG Hose should not be used in confined spaces or unventilated areas or areas exceeding the specified temperature range. Final assemblies must be tested for leaks. CNG Hose Assemblies should be tested on a monthly basis for conductivity per ANSI/IAS NGV 4.2; CSA 12.52.

Parker manufactures special Hose for aerospace in-flight applications. Aerospace in-flight applications employing Hose to transmit fuel, lubricating fluids and hydraulic fluids require a special Hose with a conductive inner tube. This Hose for in-flight applications is available only from Parker's Stratoflex Products Division. Do not use any other Parker Hose for in-flight applications, even if electrically conductive. Use of other Hoses for in-flight applications or failure to properly connect or ground this Hose can cause a fire or an explosion resulting in death, personal injury and property damage. These Hose assemblies for in-flight applications must meet all applicable aerospace industry, aircraft engine and aircraft requirements.

2.2 Pressure: Hose, Tube and Fitting selection must be made so that the published maximum working pressure of the Hose, Tube and Fittings are equal to or greater than the maximum system pressure. The maximum working pressure of a Hose, or Tube Assembly is the lower of the respective published maximum working pressures of the Hose, Tube and the Fittings used. Surge pressures or peak transient pressures in the system must be below the published maximum working pressure for the Hose, Tube and Fitting. Surge pressures and peak pressures can usually only be determined by sensitive electrical instrumentation that measures and indicates pressures at millisecond intervals. Mechanical pressure gauges indicate only average pressures and cannot be used to determine surge pressures or peak transient pressures. Published burst pressure ratings for Hose is for manufacturing test purposes only and is no indication that the Product can be used in applications at the burst pressure or otherwise above the published maximum recommended working pressure.

2.3 Suction: Hoses used for suction applications must be selected to insure that the Hose will withstand the vacuum and pressure of the system. Improperly selected Hose may collapse in suction application.

2.4 Temperature: Be certain that fluid and ambient temperatures, both steady and transient, do not exceed the limitations of the Hose, Tube, Fitting and Seals. Temperatures below and above the recommended limit can degrade Hose, Tube, Fittings and Seals to a point where a failure may occur and release fluid. Tube and Fittings performances are normally degraded at elevated temperature. Material compatibility can also change at temperatures outside of the rated range. Properly insulate and protect the Hose Assembly when routing near hot objects (e.g. manifolds). Do not use any Hose in any application where failure of the Hose could result in the conveyed fluids (or vapors or mist from the conveyed fluids) contacting any open flame, molten metal, or other potential fire ignition source that could cause burning or explosion of the conveyed fluids or vapors.

2.5 Fluid Compatibility: Hose, and Tube Assembly selection must assure compatibility of the Hose tube, cover, reinforcement, Tube, Plating and Seals with the fluid media used. See the fluid compatibility chart in the Parker publication for the product being considered or used. This information is offered only as a guide. Actual service life can only be determined by the end user by testing under all extreme conditions and other analysis.

Hose, and Tube that is chemically compatible with a particular fluid must be assembled using Fittings and adapters containing likewise compatible seals. Flange or flare processes can change Tube material properties that may not be compatible with certain requirements such as NACE

2.6 Permeation: Permeation (that is, seepage through the Hose or Seal) will occur from inside the Hose or Fitting to outside when Hose or Fitting is used with gases, liquid and gas fuels, and refrigerants (including but not limited to such materials as helium, diesel fuel, gasoline, natural gas, phosphate esters, Skydrol, or LPG). This permeation may result in high concentrations of vapors which are potentially flammable, explosive, or toxic, and in loss of fluid. Dangerous explosions, fires, and other hazards can result when using the wrong Hose for such applications. The system designer must take into account the fact that this permeation

will take place and must not use Hose or Fitting if this permeation could be hazardous. The system designer must take into account all legal, government, insurance, or any other special regulations which govern the use of fuels and refrigerants. Never use a Hose or Fitting even though the fluid compatibility is acceptable without considering the potential hazardous effects that can result from permeation through the Hose or Tube Assembly.

Permeation of moisture from outside the Hose or Fitting to inside the Hose or Fitting will also occur in Hose or Tube assemblies, regardless of internal pressure. If this moisture permeation would have detrimental effects (particularly, but not limited to refrigeration and air conditioning systems), incorporation of sufficient drying capacity in the system or other appropriate system safeguards should be selected and used. The sudden pressure release of highly pressurized gas could also result in Explosive Decompression failure of permeated Seals and Hoses.

2.7 Size: Transmission of power by means of pressurized fluid varies with pressure and rate of flow. The size of the components must be adequate to keep pressure losses to a minimum and avoid damage due to heat generation or excessive fluid velocity.

2.8 Routing: Attention must be given to optimum routing to minimize inherent problems (kinking or flow restriction due to Hose collapse, twisting of the Hose, proximity to hot objects or heat sources). For additional routing recommendations see SAE J1273 and ISO 17165-2. Hose Assemblies have a finite life and should be installed in a manner that allows for ease of inspection and future replacement. Hose because of its relative short life, should not be used in residential and commercial buildings inside of inaccessible walls or floors, unless specifically allowed in the product literature. Always review all product literature for proper installation and routing instructions.

2.9 Environment: Care must be taken to insure that the Hose, Tube and Fittings are either compatible with or protected from the environment (that is, surrounding conditions) to which they are exposed. Environmental conditions including but not limited to ultraviolet radiation, sunlight, heat, ozone, moisture, water, salt water, chemicals and air pollutants can cause degradation and premature failure.

2.10 Mechanical Loads: External forces can significantly reduce Hose, Tube and Fitting life or cause failure. Mechanical loads which must be considered include excessive flexing, twist, kinking, tensile or side loads, bend radius, and vibration. Use of swivel type Fittings or adapters may be required to insure no twist is put into the Hose. Use of proper Hose or Tube clamps may also be required to reduce external mechanical loads. Unusual applications may require special testing prior to Hose selection.

2.11 Physical Damage: Care must be taken to protect Hose from wear, snagging, kinking, bending smaller than minimum bend radius and cutting, any of which can cause premature Hose failure. Any Hose that has been kinked or bent to a radius smaller than the minimum bend radius, and any Hose that has been cut or is cracked or is otherwise damaged should be removed and discarded. Fittings with damages such as scratches on sealing surfaces and deformation should be replaced.

2.12 Proper End Fitting: See instructions 3.2 through 3.5. These recommendations may be substantiated by testing to industry standards such as SAE J517 for hydraulic applications, or MIL-A-5070, AS1339, or AS3517 for Hoses from Parker's Stratoflex Products Division for aerospace applications.

2.13 Length: When determining the proper Hose or Tube length of an assembly, be aware of Hose length change due to pressure, Tube length change due to thermal expansion or contraction, and Hose or Tube and machine tolerances and movement must be considered. When routing short hose assemblies, it is recommended that the minimum free hose length is always used. Consult the hose manufacturer for their minimum free hose length recommendations. Hose assemblies should be installed in such a way that any motion or flexing occurs within the same plane.

2.14 Specifications and Standards: When selecting Hose, Tube and Fittings, government, industry, and Parker specifications and recommendations must be reviewed and followed as applicable.

2.15 Hose Cleanliness: Hose and Tube components may vary in cleanliness levels. Care must be taken to insure that the Hose and Tube Assembly selected has an adequate level of cleanliness for the application.

2.16 Fire Resistant Fluids: Some fire resistant fluids that are to be conveyed by Hose or Tube require use of the same type of Hose or Tube as used with petroleum base fluids. Some such fluids require a special Hose, Tube, Fitting and Seal, while a few fluids will not work with any Hose at all. See instructions 2.5 and 1.5. The wrong Hose, Tube, Fitting or Seal may fail after a very short service. In addition, all liquids but pure water may burn fiercely under certain conditions, and even pure water leakage may be hazardous.





Parker Safety Guide, Parker Publication No. 4400-B.1 (continued)

- 2.17 **Radiant Heat:** Hose and Seals can be heated to destruction without contact by such nearby items as hot manifolds or molten metal. The same heat source may then initiate a fire. This can occur despite the presence of cool air around the Hose or Seal. Performance of Tube and Fitting subjected to the heat could be degraded.
- 2.18 **Welding or Brazing:** When using a torch or arc welder in close proximity to hydraulic lines, the hydraulic lines should be removed or shielded with appropriate fire resistant materials. Flame or weld spatter could burn through the Hose or Seal and possibly ignite escaping fluid resulting in a catastrophic failure. Heating of plated parts, including Hose Fittings and adapters, above 450°F (232°C) such as during welding, brazing or soldering may emit deadly gases. Any elastomer seal on fittings shall be removed prior to welding or brazing, any metallic surfaces shall be protected after brazing or welding when necessary. Welding and brazing filler material shall be compatible with the Tube and Fitting that are joined.
- 2.19 **Atomic Radiation:** Atomic radiation affects all materials used in Hose and Tube assemblies. Since the long-term effects may be unknown, do not expose Hose or Tube assemblies to atomic radiation. Nuclear applications may require special Tube and Fittings.
- 2.20 **Aerospace Applications:** The only Hose, Tube and Fittings that may be used for in-flight aerospace applications are those available from Parker's Stratoflex Products Division. Do not use any other Hose or Fittings for in-flight applications. Do not use any Hose or Fittings from Parker's Stratoflex Products Division with any other Hose or Fittings, unless expressly approved in writing by the engineering manager or chief engineer of Stratoflex Products Division and verified by the user's own testing and inspection to aerospace industry standards.
- 2.21 **Unlocking Couplings:** Ball locking couplings or other Fittings with quick disconnect ability can unintentionally disconnect if they are dragged over obstructions, or if the sleeve or other disconnect member, is bumped or moved enough to cause disconnect. Threaded Fittings should be considered where there is a potential for accidental uncoupling.
- 3.0 **HOSE AND FITTINGS ASSEMBLY AND INSTALLATION INSTRUCTIONS**
- 3.1 **Component Inspection:** Prior to assembly, a careful examination of the Hose and Fittings must be performed. All components must be checked for correct style, size, catalog number, and length. The Hose must be examined for cleanliness, obstructions, blisters, cover looseness, kinks, cracks, cuts or any other visible defects. Inspect the Fitting and sealing surfaces for burrs, nicks, corrosion or other imperfections. Do NOT use any component that displays any signs of nonconformance.
- 3.2 **Hose and Fitting Assembly:** Do not assemble a Parker Fitting on a Parker Hose that is not specifically listed by Parker for that Fitting, unless authorized in writing by the engineering manager or chief engineer of the appropriate Parker division. Do not assemble a Parker Fitting on another manufacturer's Hose or a Parker Hose on another manufacturer's Fitting unless (i) the engineering manager or chief engineer of the appropriate Parker division approves the Assembly in writing or that combination is expressly approved in the appropriate Parker literature for the specific Parker product, and (ii) the user verifies the Assembly and the application through analysis and testing. For Parker Hose that does not specify a Parker Fitting, the user is solely responsible for the selection of the proper Fitting and Hose Assembly procedures. See instruction 1.4.

To prevent the possibility of problems such as leakage at the Fitting or system contamination, it is important to completely remove all debris from the cutting operation before installation of the Fittings. The Parker published instructions must be followed for assembling the Fittings on the Hose. These instructions are provided in the Parker Fitting catalog for the specific Parker Fitting being used, or by calling 1-800-CPARKER, or at www.parker.com.
- 3.3 **Related Accessories:** Do not crimp or swage any Parker Hose or Fitting with anything but the listed swage or crimp machine and dies in accordance with Parker published instructions. Do not crimp or swage another manufacturer's Fitting with a Parker crimp or swage die unless authorized in writing by the engineering manager or chief engineer of the appropriate Parker division.
- 3.4 **Parts:** Do not use any Parker Fitting part (including but not limited to socket, shell, nipple, or insert) except with the correct Parker mating parts, in accordance with Parker published instructions, unless authorized in writing by the engineering manager or chief engineer of the appropriate Parker division.
- 3.5 **Field Attachable/Permanent:** Do not reuse any field attachable Hose Fitting that has blown or pulled off a Hose. Do not reuse a Parker permanent Hose

Fitting (crimped or swaged) or any part thereof. Complete Hose Assemblies may only be reused after proper inspection under section 4.0. Do not assemble Fittings to any previously used hydraulic Hose that was in service, for use in a fluid power application.

- 3.6 **Pre-Installation Inspection:** Prior to installation, a careful examination of the Hose Assembly must be performed. Inspect the Hose Assembly for any damage or defects. DO NOT use any Hose Assembly that displays any signs of nonconformance.
- 3.7 **Minimum Bend Radius:** Installation of a Hose at less than the minimum listed bend radius may significantly reduce the Hose life. Particular attention must be given to preclude sharp bending at the Hose to Fitting juncture. Any bending during installation at less than the minimum bend radius must be avoided. If any Hose is kinked during installation, the Hose must be discarded.
- 3.8 **Twist Angle and Orientation:** Hose Assembly installation must be such that relative motion of machine components does not produce twisting.
- 3.9 **Securement:** In many applications, it may be necessary to restrain, protect, or guide the Hose to protect it from damage by unnecessary flexing, pressure surges, and contact with other mechanical components. Care must be taken to insure such restraints do not introduce additional stress or wear points.
- 3.10 **Proper Connection of Ports:** Proper physical installation of the Hose Assembly requires a correctly installed port connection insuring that no twist or torque is transferred to the Hose when the Fittings are being tightened or otherwise during use.
- 3.11 **External Damage:** Proper installation is not complete without insuring that tensile loads, side loads, kinking, flattening, potential abrasion, thread damage or damage to sealing surfaces are corrected or eliminated. See instruction 2.10.
- 3.12 **System Checkout:** All air entrapment must be eliminated and the system pressurized to the maximum system pressure (at or below the Hose maximum working pressure) and checked for proper function and freedom from leaks. Personnel must stay out of potential hazardous areas while testing and using.
- 3.13 **Routing:** The Hose Assembly should be routed in such a manner so if a failure does occur, the escaping media will not cause personal injury or property damage. In addition, if fluid media comes in contact with hot surfaces, open flame or sparks, a fire or explosion may occur. See section 2.4.
- 3.14 **Ground Fault Equipment Protection Devices (GFEPDs): WARNING! Fire and Shock Hazard.** To minimize the danger of fire if the heating cable of a Multitube bundle is damaged or improperly installed, use a Ground Fault Equipment Protection Device. Electrical fault currents may be insufficient to trip a conventional circuit breaker.

For ground fault protection, the IEEE 515: (www.ansi.org) standard for heating cables recommends the use of GFEPDs with a nominal 30 milliamperes trip level for "piping systems in classified areas, those areas requiring a high degree of maintenance, or which may be exposed to physical abuse or corrosive atmospheres".
- 4.0 **TUBE AND FITTINGS ASSEMBLY AND INSTALLATION INSTRUCTIONS**
- 4.1 **Component Inspection:** Prior to assembly, a careful examination of the Tube and Fittings must be performed. All components must be checked for correct style, size, material, seal, and length. Inspect the Fitting and sealing surfaces for burrs, nicks, corrosion, missing seal or other imperfections. Do NOT use any component that displays any signs of nonconformance.
- 4.2 **Tube and Fitting Assembly:** Do not assemble a Parker Fitting with a Tube that is not specifically listed by Parker for that Fitting, unless authorized in writing by the engineering manager or chief engineer of the appropriate Parker division. The Tube must meet the requirements specified to the Fitting.

The Parker published instructions must be followed for assembling the Fittings to a Tube. These instructions are provided in the Parker Fitting catalog for the specific Parker Fitting being used, or by calling 1-800-CPARKER, or at www.parker.com.
- 4.3 **Related Accessories:** Do not preset or flange Parker Fitting components using another manufacturer's equipment or procedures unless authorized in writing by the engineering manager or chief engineer of the appropriate Parker division. Tube, Fitting component and tooling must be checked for correct style, size and material. Operation and maintenance of Related Accessories must be in accordance with the operation manual for the designated Accessory.
- 4.4 **Securement:** In many applications, it may be necessary to restrain, protect, or guide the Tube to protect it from damage by unnecessary flexing, pressure surges, vibration, and contact with other mechanical components. Care must be taken to insure such restraints do not introduce additional stress or wear points.





Parker Safety Guide, Parker Publication No. 4400-B.1 (continued)

- 4.5 **Proper Connection of Ports:** Proper physical installation of the Tube Assembly requires a correctly installed port connection insuring that no torque is transferred to the Tube when the Fittings are being tightened or otherwise during use.
- 4.6 **External Damage:** Proper installation is not complete without insuring that tensile loads, side loads, flattening, potential abrasion, thread damage or damage to sealing surfaces are corrected or eliminated. See instruction 2.10.
- 4.7 **System Checkout:** All air entrapment must be eliminated and the system pressurized to the maximum system pressure (at or below the Tube Assembly maximum working pressure) and checked for proper function and freedom from leaks. Personnel must stay out of potential hazardous areas while testing and using.
- 4.8 **Routing:** The Tube Assembly should be routed in such a manner so if a failure does occur, the escaping media will not cause personal injury or property damage. In addition, if fluid media comes in contact with hot surfaces, open flame or sparks, a fire or explosion may occur. See section 2.4.
- 5.0 **HOSE AND FITTING MAINTENANCE AND REPLACEMENT INSTRUCTIONS**
- 5.1 Even with proper selection and installation, Hose life may be significantly reduced without a continuing maintenance program. The severity of the application, risk potential from a possible Hose failure, and experience with any Hose failures in the application or in similar applications should determine the frequency of the inspection and the replacement for the Products so that Products are replaced before any failure occurs. Certain products require maintenance and inspection per industry requirements. Failure to adhere to these requirements may lead to premature failure. A maintenance program must be established and followed by the user and, at minimum, must include instructions 5.2 through 5.7
- 5.2 **Visual Inspection Hose/Fitting:** Any of the following conditions require immediate shut down and replacement of the Hose Assembly:
 - Fitting slippage on Hose;
 - Damaged, cracked, cut or abraded cover (any reinforcement exposed);
 - Hard, stiff, heat cracked, or charred Hose;
 - Cracked, damaged, or badly corroded Fittings;
 - Leaks at Fitting or in Hose;
 - Kinked, crushed, flattened or twisted Hose; and
 - Blistered, soft, degraded, or loose cover.
- 5.3 **Visual Inspection All Other:** The following items must be tightened, repaired, corrected or replaced as required:
 - Leaking port conditions;
 - Excess dirt buildup;/
 - Worn clamps, guards or shields; and
 - System fluid level, fluid type, and any air entrapment.
- 5.4 **Functional Test:** Operate the system at maximum operating pressure and check for possible malfunctions and leaks. Personnel must avoid potential hazardous areas while testing and using the system. See section 2.2.
- 5.5 **Replacement Intervals:** Hose assemblies and elastomeric seals used on Hose Fittings and adapters will eventually age, harden, wear and deteriorate under thermal cycling and compression set. Hose Assemblies and elastomeric seals should be inspected and replaced at specific replacement intervals, based on previous service life, government or industry recommendations, or when failures could result in unacceptable downtime, damage, or injury risk. See section 1.2. Hose and Fittings may be subjected to internal mechanical and/or chemical wear from the conveying fluid and may fail without warning. The user must determine the product life under such circumstances by testing. Also see section 2.5.
- 5.6 **Hose Inspection and Failure:** Hydraulic power is accomplished by utilizing high pressure fluids to transfer energy and do work. Hoses, Fittings and Hose Assemblies all contribute to this by transmitting fluids at high pressures. Fluids under pressure can be dangerous and potentially lethal and, therefore, extreme caution must be exercised when working with fluids under pressure and handling the Hoses transporting the fluids. From time to time, Hose

Assemblies will fail if they are not replaced at proper time intervals. Usually these failures are the result of some form of misapplication, abuse, wear or failure to perform proper maintenance. When Hoses fail, generally the high pressure fluids inside escape in a stream which may or may not be visible to the user. Under no circumstances should the user attempt to locate the leak by "feeling" with their hands or any other part of their body. High pressure fluids can and will penetrate the skin and cause severe tissue damage and possibly loss of limb. Even seemingly minor hydraulic fluid injection injuries must be treated immediately by a physician with knowledge of the tissue damaging properties of hydraulic fluid.

If a Hose failure occurs, immediately shut down the equipment and leave the area until pressure has been completely released from the Hose Assembly. Simply shutting down the hydraulic pump may or may not eliminate the pressure in the Hose Assembly. Many times check valves, etc., are employed in a system and can cause pressure to remain in a Hose Assembly even when pumps or equipment are not operating. Tiny holes in the Hose, commonly known as pinholes, can eject small, dangerously powerful but hard to see streams of hydraulic fluid. It may take several minutes or even hours for the pressure to be relieved so that the Hose Assembly may be examined safely.

Once the pressure has been reduced to zero, the Hose Assembly may be taken off the equipment and examined. It must always be replaced if a failure has occurred. Never attempt to patch or repair a Hose Assembly that has failed. Consult the nearest Parker distributor or the appropriate Parker division for Hose Assembly replacement information.

Never touch or examine a failed Hose Assembly unless it is obvious that the Hose no longer contains fluid under pressure. The high pressure fluid is extremely dangerous and can cause serious and potentially fatal injury.

- 5.7 **Elastomeric seals:** Elastomeric seals will eventually age, harden, wear and deteriorate under thermal cycling and compression set. Elastomeric seals should be inspected and replaced.
- 5.8 **Refrigerant gases:** Special care should be taken when working with refrigeration systems. Sudden escape of refrigerant gases can cause blindness if the escaping gases contact the eye and can cause freezing or other severe injuries if it contacts any other portion of the body.
- 5.9 **Compressed natural gas (CNG):** Parker CNG Hose Assemblies should be tested after installation and before use, and at least on a monthly basis per instructions provided on the Hose Assembly tag. The recommended procedure is to pressurize the Hose and check for leaks and to visually inspect the Hose for damage and to perform an electrical resistance test.
 - Caution:** Matches, candles, open flame or other sources of ignition shall not be used for Hose inspection. Leak check solutions should be rinsed off after use.
- 6.0 **HOSE STORAGE**
- 6.1 **Age Control:** Hose and Hose Assemblies must be stored in a manner that facilitates age control and first-in and first-out usage based on manufacturing date of the Hose and Hose Assemblies. Unless otherwise specified by the manufacturer or defined by local laws and regulations:
 - 6.1.1 The shelf life of rubber hose in bulk form or hose made from two or more materials is 28 quarters (7 years) from the date of manufacture, with an extension of 12 quarters (3 years), if stored in accordance with ISO 2230;
 - 6.1.2 The shelf life of thermoplastic and polytetrafluoroethylene hose is considered to be unlimited;
 - 6.1.3 Hose assemblies that pass visual inspection and proof test shall not be stored for longer than 2 years.
 - 6.1.4 **Storage:** Stored Hose and Hose Assemblies must not be subjected to damage that could reduce their expected service life and must be placed in a cool, dark and dry area with the ends capped. Stored Hose and Hose Assemblies must not be exposed to temperature extremes, ozone, oils, corrosive liquids or fumes, solvents, high humidity, rodents, insects, ultraviolet light, electromagnetic fields or radioactive materials.

Issue Date	ECO Number:	Revision Letter:	Revision Date:	Specification
24-SEP-2015	XXXXXX	A	30-OCT-2015	FC-Safety Guide

THIS DOCUMENT CONTAINS INFORMATION THAT IS CONFIDENTIAL AND PROPRIETARY TO PARKER HANNIFIN. THIS DOCUMENT IS FURNISHED ON THE UNDERSTANDING THAT THE DOCUMENT AND THE INFORMATION IT CONTAINS WILL NOT BE COPIED OR DISCLOSED TO OTHERS EXCEPT WITH THE WRITTEN CONSENT OF PARKER, WILL NOT BE USED FOR ANY PURPOSE OTHER THAN CONDUCTING BUSINESS WITH PARKER, AND WILL BE RETURNED AND ALL FURTHER USE DISCONTINUED UPON REQUEST BY PARKER. COPYRIGHT PARKER. YEAR OF COPYRIGHT IS FIRST YEAR INDICATED ON THIS DOCUMENT. ALL RIGHTS RESERVED



Offer of Sale



- Definitions.** As used herein, the following terms have the meanings indicated.
 - Buyer:** means any customer receiving a Quote for Products from Seller.
 - Goods:** means any tangible part, system or component to be supplied by the Seller.
 - Products:** means the Goods, Services and/or Software as described in a Quote provided by the Seller.
 - Quote:** means the offer or proposal made by Seller to Buyer for the supply of Products.
 - Seller:** means Parker-Hannifin Corporation, including all divisions and businesses thereof.
 - Services:** means any services to be supplied by the Seller.
 - Software:** means any software related to the Products, whether embedded or separately downloaded.
 - Terms:** means the terms and conditions of this Offer of Sale or any newer version of the same as published by Seller electronically at www.parker.com/saleterms.
- Terms.** All sales of Products by Seller are contingent upon, and will be governed by, these Terms and, these Terms are incorporated into any Quote provided by Seller to any Buyer. Buyer's order for any Products whether communicated to Seller verbally, in writing, by electronic data interface or other electronic commerce, shall constitute acceptance of these Terms. Seller objects to any contrary or additional terms or conditions of Buyer. Reference in Seller's order acknowledgement to Buyer's purchase order or purchase order number shall in no way constitute an acceptance of any of Buyer's terms of purchase. No modification to these Terms will be binding on Seller unless agreed to in writing and signed by an authorized representative of Seller.
- Price; Payment.** The Products set forth in Seller's Quote are offered for sale at the prices indicated in Seller's Quote. Unless otherwise specifically stated in Seller's Quote, prices are valid for thirty (30) days and do not include any sales, use, or other taxes or duties. Seller reserves the right to modify prices at any time to adjust for any raw material price fluctuations. Unless otherwise specified by Seller, all prices are F.C.A. Seller's facility (INCOTERMS 2010). All sales are contingent upon credit approval and payment for all purchases is due thirty (30) days from the date of invoice (or such date as may be specified in the Quote). Unpaid invoices beyond the specified payment date incur interest at the rate of 1.5% per month or the maximum allowable rate under applicable law.
- Shipment; Delivery; Title and Risk of Loss.** All delivery dates are approximate. Seller is not responsible for damages resulting from any delay. Regardless of the manner of shipment, delivery occurs and title and risk of loss or damage pass to Buyer, upon placement of the Products with the shipment carrier at Seller's facility. Unless otherwise agreed, Seller may exercise its judgment in choosing the carrier and means of delivery. No deferral of shipment at Buyer's request beyond the respective indicated shipping date will be made except on terms that will indemnify, defend and hold Seller harmless against all loss and additional expense. Buyer shall be responsible for any additional shipping charges incurred by Seller due to Buyer's acts or omissions.
- Warranty.** The warranty related to the Products is as follows: (i) Goods are warranted against defects in material or workmanship for a period of twelve (12) months from the date of delivery or 2,000 hours of use, whichever occurs first; (ii) Services shall be performed in accordance with generally accepted practices and using the degree of care and skill that is ordinarily exercised and customary in the field to which the Services pertain and are warranted for a period of six (6) months from the completion of the Services by Seller; and (iii) Software is only warranted to perform in accordance with applicable specifications provided by Seller to Buyer for ninety (90) days from the date of delivery or, when downloaded by a Buyer or end-user, from the date of the initial download. All prices are based upon the exclusive limited warranty stated above, and upon the following disclaimer:
DISCLAIMER OF WARRANTY: THIS WARRANTY IS THE SOLE AND ENTIRE WARRANTY PERTAINING TO PRODUCTS. SELLER DISCLAIMS ALL OTHER WARRANTIES, EXPRESS AND IMPLIED, INCLUDING DESIGN, NONINFRINGEMENT, MERCHANTABILITY, AND FITNESS FOR A PARTICULAR PURPOSE. SELLER DOES NOT WARRANT THAT THE SOFTWARE IS ERROR-FREE OR FAULT-TOLERANT, OR THAT BUYER'S USE THEREOF WILL BE SECURE OR UNINTERRUPTED. BUYER AGREES AND ACKNOWLEDGES THAT UNLESS OTHERWISE AUTHORIZED IN WRITING BY SELLER THE SOFTWARE SHALL NOT BE USED IN CONNECTION WITH HAZARDOUS OR HIGH RISK ACTIVITIES OR ENVIRONMENTS. EXCEPT AS EXPRESSLY STATED HEREIN, ALL PRODUCTS ARE PROVIDED "AS IS".
- Claims; Commencement of Actions.** Buyer shall promptly inspect all Products upon receipt. No claims for shortages will be allowed unless reported to the Seller within ten (10) days of delivery. Buyer shall notify Seller of any alleged breach of warranty within thirty (30) days after the date the non-conformance is or should have been discovered by Buyer. Any claim or action against Seller based upon breach of contract or any other theory, including tort, negligence, or otherwise must be commenced within twelve (12) months from the date of the alleged breach or other alleged event, without regard to the date of discovery.
- LIMITATION OF LIABILITY.** IN THE EVENT OF A BREACH OF WARRANTY, SELLER WILL, AT ITS OPTION, REPAIR OR REPLACE THE NON-CONFORMING PRODUCT, RE-PERFORM THE SERVICES, OR REFUND THE PURCHASE PRICE PAID WITHIN A REASONABLE PERIOD OF TIME. IN NO EVENT IS SELLER LIABLE FOR ANY SPECIAL, INDIRECT, INCIDENTAL OR CONSEQUENTIAL DAMAGES ARISING OUT OF, OR AS THE RESULT OF, THE SALE, DELIVERY, NON-DELIVERY, SERVICING, NON-COMPLETION OF SERVICES, USE, LOSS OF USE OF, OR INABILITY TO USE THE PRODUCTS OR ANY PART THEREOF, LOSS OF DATA, IDENTITY, PRIVACY, OR CONFIDENTIALITY, OR FOR ANY CHARGES OR EXPENSES OF ANY NATURE INCURRED WITHOUT SELLER'S WRITTEN CONSENT, WHETHER BASED IN CONTRACT, TORT OR OTHER LEGAL THEORY. IN NO EVENT SHALL SELLER'S LIABILITY UNDER ANY CLAIM MADE BY BUYER EXCEED THE PURCHASE PRICE PAID FOR THE PRODUCTS.
- Loss to Buyer's Property.** Any designs, tools, patterns, materials, drawings, confidential information or equipment furnished by Buyer or any other items which are or become Buyer's property, will be considered obsolete and may be destroyed by Seller after two (2) consecutive years have elapsed without Buyer ordering the Products manufactured using such property. Seller shall not be responsible for any loss or damage to such property while it is in Seller's possession or control.
- Special Tooling.** Special Tooling includes but is not limited to tooling, jigs, fixtures and associated manufacturing equipment acquired or necessary to manufacture Products. A tooling charge may be imposed for any Special Tooling. Such Special Tooling shall be and remain Seller's property notwithstanding payment of any charges by Buyer. In no event will Buyer acquire any interest in Special Tooling belonging to Seller that is utilized in the manufacture of the Products, even if such Special Tooling has been specially converted or adapted for such manufacture and notwithstanding any charges paid by Buyer. Unless otherwise agreed, Seller has the right to alter, discard or otherwise dispose of any Special Tooling or other property in its sole discretion at any time.
- Security Interest.** To secure payment of all sums due, Seller retains a security interest in all Products delivered to Buyer and, Buyer's acceptance of these Terms is deemed to be a Security Agreement under the Uniform Commercial Code. Buyer authorizes Seller as its attorney to execute and file on Buyer's behalf all documents Seller deems necessary to perfect its security interest.
- User Responsibility.** The Buyer through its own analysis and testing, is solely responsible for making the final selection of the Products and assuring that all performance, endurance, maintenance, safety and warning requirements of the application of the Products are met. The Buyer must analyze all aspects of the application and follow applicable industry standards, specifications, and other technical information provided with the Product. If Seller provides Product options based upon data or specifications provided by the Buyer, the Buyer is responsible for determining that such data and specifications are suitable and sufficient for all applications and reasonably foreseeable uses of the Products. In the event the Buyer is not the end-user, Buyer will ensure such end-user complies with this paragraph.
- Use of Products. Indemnity by Buyer.** Buyer shall comply with all instructions, guides and specifications provided by Seller with the Products. **Unauthorized Uses.** If Buyer uses or resells the Products for any uses prohibited in Seller's instructions, guides or specifications, or Buyer otherwise fails to comply with Seller's instructions, guides and specifications, Buyer acknowledges that any such use, resale, or non-compliance is at Buyer's sole risk. Buyer shall indemnify, defend, and hold Seller harmless from any losses, claims, liabilities, damages, lawsuits, judgments and costs (including attorney fees and defense costs), whether for personal injury, property damage, intellectual property infringement or any other claim, brought by or incurred by Buyer, Buyer's employees, or any other person, arising out of: (a) improper selection, application, design, specification or other misuse of Products provided by Seller; (b) any act or omission, negligent or otherwise,





of Buyer; (c) Seller's use of patterns, tooling, equipment, plans, drawings, designs or specifications or other information or things furnished by Buyer; (d) damage to the Products from an external cause, repair or attempted repair by anyone other than Seller, failure to follow instructions, guides and specifications provided by Seller, use with goods not provided by Seller, or opening, modifying, deconstructing or tampering with the Products for any reason; or (e) Buyer's failure to comply with these Terms. Seller shall not indemnify Buyer under any circumstance except as otherwise provided in these Terms.

13. **Cancellations and Changes.** Buyer may not cancel or modify any order for any reason, except with Seller's written consent and upon terms that will indemnify, defend and hold Seller harmless against all direct, incidental and consequential loss or damage. Seller, at any time, may change Product features, specifications, designs and availability.

14. **Limitation on Assignment.** Buyer may not assign its rights or obligations without the prior written consent of Seller.

15. **Force Majeure.** Seller does not assume the risk and is not liable for delay or failure to perform any of Seller's obligations by reason of events or circumstances beyond its reasonable control ("Events of Force Majeure"). Events of Force Majeure shall include without limitation: accidents, strikes or labor disputes, acts of any government or government agency, acts of nature, delays or failures in delivery from carriers or suppliers, shortages of materials, or any other cause beyond Seller's reasonable control.

16. **Waiver and Severability.** Failure to enforce any provision of these Terms will not invalidate that provision; nor will any such failure prejudice Seller's right to enforce that provision in the future. Invalidation of any provision of these Terms by legislation or other rule of law shall not invalidate any other provision herein and, the remaining provisions will remain in full force and effect.

17. **Termination.** Seller may terminate any agreement governed by or arising from these Terms for any reason and at any time by giving Buyer thirty (30) days prior written notice. Seller may immediately terminate, in writing, if Buyer: (a) breaches any provision of these Terms (b) appoints a trustee, receiver or custodian for all or any part of Buyer's property (c) files a petition for relief in bankruptcy on its own behalf, or one if filed by a third party (d) makes an assignment for the benefit of creditors; or (e) dissolves its business or liquidates all or a majority of its assets.

18. **Ownership of Software.** Seller retains ownership of all Software supplied to Buyer hereunder. In no event shall Buyer obtain any greater right in and to the Software than a right in the nature of a license limited to the use thereof and subject to compliance with any other terms provided with the Software.

19. **Indemnity for Infringement of Intellectual Property Rights.** Seller is not liable for infringement of any patents, trademarks, copyrights, trade dress, trade secrets or similar rights ("Intellectual Property Rights") except as provided in this Section. Seller will defend at its expense and will pay the cost of any settlement or damages awarded in an action brought against Buyer based on a third party claim that one or more of the Products sold hereunder infringes the Intellectual Property Rights of a third party in the country of delivery of the Products by the Seller to the Buyer. Seller's obligation to defend and indemnify Buyer is contingent on Buyer notifying Seller within ten (10) days after Buyer becomes aware of any such claim, and Seller having sole control over the defense of the claim including all negotiations for settlement or compromise. If one or more Products sold hereunder is subject to such a claim, Seller may, at its sole expense and option, procure for Buyer the right to continue using the Products, replace or modify the Products so as to render them non-infringing, or offer to accept return of the Products and refund the purchase price less a reasonable allowance for depreciation. Seller has no obligation or liability for any claim of infringement: (i) arising from information provided by Buyer; or (ii) directed to any Products provided hereunder for which the designs are specified in whole or part by Buyer; or (iii) resulting from the modification, combination or use in a system of any Products provided hereunder. The foregoing provisions of this Section constitute Seller's sole and exclusive liability and Buyer's sole and exclusive remedy for such claims of infringement of Intellectual Property Rights.

20. **Governing Law.** These Terms and the sale and delivery of all Products are deemed to have taken place in, and shall be governed and construed in accordance with, the laws of the State of Ohio, as applicable to contracts executed and wholly performed therein and without regard to conflicts of laws principles. Buyer irrevocably agrees and consents to the exclusive jurisdiction and venue of the courts of Cuyahoga County, Ohio with respect to any dispute, controversy or claim arising out of or relating to the sale and delivery of the Products.

21. **Entire Agreement.** These Terms, along with the terms set forth in the main body of any Quote, forms the entire agreement between the Buyer and Seller and constitutes the final, complete and exclusive expression of the terms of sale. In the event of a conflict between any term set forth in the main body of a

Quote and these Terms, the terms set forth in the main body of the Quote shall prevail. All prior or contemporaneous written or oral agreements or negotiations with respect to the subject matter shall have no effect. These Terms may not be modified unless in writing and signed by an authorized representative of Seller.

22. **Compliance with Laws.** Buyer agrees to comply with all applicable laws, regulations, and industry and professional standards, including those of the United States of America, and the country or countries in which Buyer may operate, including without limitation the U.S. Foreign Corrupt Practices Act ("FCPA"), the U.S. Anti-Kickback Act ("Anti-Kickback Act"), U.S. and E.U. export control and sanctions laws ("Export Laws"), the U.S. Food Drug and Cosmetic Act ("FDCA"), and the rules and regulations promulgated by the U.S. Food and Drug Administration ("FDA"), each as currently amended. Buyer agrees to indemnify, defend, and hold harmless Seller from the consequences of any violation of such laws, regulations and standards by Buyer, its employees or agents. Buyer acknowledges that it is familiar with all applicable provisions of the FCPA, the Anti-Kickback Act, Export Laws, the FDCA and the FDA and certifies that Buyer will adhere to the requirements thereof and not take any action that would make Seller violate such requirements. Buyer represents and agrees that Buyer will not make any payment or give anything of value, directly or indirectly, to any governmental official, foreign political party or official thereof, candidate for foreign political office, or commercial entity or person, for any improper purpose, including the purpose of influencing such person to purchase Products or otherwise benefit the business of Seller. Buyer further represents and agrees that it will not receive, use, service, transfer or ship any Product from Seller in a manner or for a purpose that violates Export Laws or would cause Seller to be in violation of Export Laws.



Parker's Motion & Control Product Groups

At Parker, we're guided by a relentless drive to help our customers become more productive and achieve higher levels of profitability by engineering the best systems for their requirements. It means looking at customer applications from many angles to find new ways to create value. Whatever the motion and control technology need, Parker has the experience, breadth of product and global reach to consistently deliver. No company knows more about motion and control technology than Parker. For further info call 1 800 C-Parker (1 800 272 7537).



Aerospace

Key Markets

Aftermarket services
Commercial transports
Engines
General & business aviation
Helicopters
Launch vehicles
Military aircraft
Missiles
Power generation
Regional transports
Unmanned aerial vehicles

Key Products

Control systems & actuation products
Engine systems & components
Fluid conveyance systems & components
Fluid metering, delivery & atomization devices
Fuel systems & components
Fuel tank inerting systems
Hydraulic systems & components
Thermal management
Wheels & brakes



Automation

Key Markets

Alternative energy
Conveyor & material handling
Factory automation
Food & beverage
Life sciences & medical
Machine tools
Packaging machinery
Paper machinery
Plastics machinery
Primary metals
Safety & security
Semiconductor & electronics
Transportation & automotive

Key Products

AC/DC drives & systems
Air preparation
Electric actuators, gantry robots & slides
Human machine interfaces
Inverters
Manifolds
Miniature fluidics
Pneumatic actuators & grippers
Pneumatic valves & controls
Rotary actuators
Stepper motors, servo motors, drives & controls
Structural extrusions
Vacuum generators, cups & sensors



Climate & Industrial Controls

Key Markets

Agriculture
Air conditioning
Construction Machinery
Food & beverage
Industrial machinery
Life sciences
Oil & gas
Precision cooling
Process
Refrigeration
Transportation

Key Products

Accumulators
Advanced actuators
CO₂ controls
Electronic controllers
Filter driers
Hand shut-off valves
Heat exchangers
Hose & fittings
Pressure regulating valves
Refrigerant distributors
Safety relief valves
Smart pumps
Solenoid valves
Thermostatic expansion valves



Filtration

Key Markets

Aerospace
Food & beverage
Industrial plant & equipment
Life sciences
Marine
Mobile equipment
Oil & gas
Power generation & renewable energy
Process
Transportation
Water Purification

Key Products

Analytical gas generators
Compressed air filters & dryers
Engine air, coolant, fuel & oil filtration systems
Fluid condition monitoring systems
Hydraulic & lubrication filters
Hydrogen, nitrogen & zero air generators
Instrumentation filters
Membrane & fiber filters
Microfiltration
Sterile air filtration
Water desalination & purification filters & systems

TABLE OF CONTENTS



Fluid Connectors

Key Markets

Aerial lift
Agriculture
Bulk chemical handling
Construction machinery
Food & beverage
Fuel & gas delivery
Industrial machinery
Life sciences
Marine
Mining
Mobile
Oil & gas
Renewable energy
Transportation

Key Products

Check valves
Connectors for low pressure fluid conveyance
Deep sea umbilicals
Diagnostic equipment
Hose couplings
Industrial hose
Mooring systems & power cables
PTFE hose & tubing
Quick couplings
Rubber & thermoplastic hose
Tube fittings & adapters
Tubing & plastic fittings



Hydraulics

Key Markets

Agriculture
Alternative energy
Construction machinery
Forestry
Industrial machinery
Machine tools
Marine
Material handling
Mining
Oil & gas
Power generation
Refuse vehicles
Renewable energy
Truck hydraulics
Turf equipment

Key Products

Accumulators
Cartridge valves
Electrohydraulic actuators
Human machine interfaces
Hybrid drives
Hydraulic cylinders
Hydraulic motors & pumps
Hydraulic systems
Hydraulic valves & controls
Hydrostatic steering
Integrated hydraulic circuits
Power take-offs
Power units
Rotary actuators
Sensors



Instrumentation

Key Markets

Alternative fuels
Biopharmaceuticals
Chemical & refining
Food & beverage
Marine & shipbuilding
Medical & dental
Microelectronics
Nuclear Power
Offshore oil exploration
Oil & gas
Pharmaceuticals
Power generation
Pulp & paper
Steel
Water/wastewater

Key Products

Analytical Instruments
Analytical sample conditioning products & systems
Chemical injection fittings & valves
Fluoropolymer chemical delivery fittings, valves & pumps
High purity gas delivery fittings, valves, regulators & digital flow controllers
Industrial mass flow meters/ controllers
Process control double block & bleeds
Process control fittings, valves, regulators & manifold valves
Permanent no-weld tube fittings
Precision industrial regulators & flow controllers



Seal

Key Markets

Aerospace
Chemical processing
Consumer
Fluid power
General industrial
Information technology
Life sciences
Microelectronics
Military
Oil & gas
Power generation
Renewable energy
Telecommunications
Transportation

Key Products

Dynamic seals
Elastomeric o-rings
Electro-medical instrument design & assembly
EMI shielding
Extruded & precision-cut, fabricated elastomeric seals
High temperature metal seals
Homogeneous & inserted elastomeric shapes
Medical device fabrication & assembly
Metal & plastic retained composite seals
Shielded optical windows
Silicone tubing & extrusions
Thermal management
Vibration dampening



ENGINEERING YOUR SUCCESS.



The Hope Group Branch Locations

Your complete source for quality tube fittings, hose & hose fittings, brass & composite fittings, quick-disconnect couplings, valves and assembly tools, locally available from a worldwide network of authorized distributors.

Fittings:

Available in inch and metric sizes covering SAE, BSP, DIN, GAZ, JIS and ISO thread configurations, manufactured from steel, stainless steel, brass, aluminum, nylon and thermoplastic.

Hose, Tubing and Bundles:

Available in a wide variety of sizes and materials including rubber, wire-reinforced, thermoplastic, hybrid and custom compounds.

Worldwide Availability:

Parker operates Fluid Connectors manufacturing locations and sales offices throughout North America, South America, Europe and Asia-Pacific.

For information, call

508-393-7660

Massachusetts

Fitchburg

Parker Store
58 Crawford Street
Tel: 978-342-6817
Fax: 978-345-7604

Northborough

Corporate Headquarters
70 Bearfoot Road
Tel: 508-393-7660
Fax: 508-393-8203

Weymouth

Parker Store
50 Finnell Drive, Unit 12-14
Tel: 781-803-2572
Fax: 781-812-2641

Rhode Island

Cranston

Parker Store
215 Niantic Avenue
Tel: 401-943-1577
Fax: 401-943-8808

Connecticut

North Haven

The Hope Group - No. Haven
350 Sackett Point Road
Tel: 203-269-1299
Fax: 203-891-7649

Maine

Bangor

Parker Store
257 Perry Road
Tel: 207-942-7475
Fax: 207-941-9875

Lewiston

Parker Store
14 Enterprise Street
Tel: 207-783-9108
Fax: 207-782-8634

South Portland

Parker Store
5 Wallace Avenue
Tel: 207-774-6266
Fax: 207-774-4735

New Hampshire

Manchester

Parker Store
880 Candia Road
Tel: 603-622-4998
Fax: 603-622-4667



The Hope Group
70 Bearfoot Road
Northborough, MA 01532
Phone: 508-393-7660
Fax: 508-393-8203
www.TheHopeGroup.com

ISO 9001:2008 Certified
ITAR Registered