

Finite Compressed Air and Gas Filtration Products

Technical Reference Manual 1300-300-18/USA



ENGINEERING YOUR SUCCESS.

Parker Hannifin Corporation

The Global Leader in Motion and Control Technologies

We engineer success of our customers around the world, drawing upon nine core motion and control technologies. These technologies enable virtually every machine and process to operate accurately, efficiently and dependably.

As the global leader in motion and control, we partner with our distributors to increase our customers' productivity and profitability by delivering an unmatched breadth of engineered components and value-added services.

We continue to grow with our customers by creating application-focused products and system solutions. A key to our global expansion has been to follow our customers and establish operations, sales and service wherever they are needed. No single competitor matches Parker's global presence.



Corporate Headquarters
in Cleveland, Ohio.

Parker's Motion and Control Technologies

Aerospace	Hydraulics
Climate Control	Pneumatics
Electromechanical	Process Control
Filtration	Sealing & Shielding
Fluid & Gas Handling	

Legal Notifications



WARNING

FAILURE OR IMPROPER SELECTION OR IMPROPER USE OF THE PRODUCTS AND/OR SYSTEMS DESCRIBED HEREIN OR RELATED ITEMS CAN CAUSE DEATH, PERSONAL INJURY AND PROPERTY DAMAGE.

This document and other information from Parker Hannifin Corporation, its subsidiaries and authorized distributors provide product and/or system options for further investigation by users having technical expertise. It is important that you analyze all aspects of your application and review the information concerning the product or system in the current product catalog. Due to the variety of operating conditions and applications for these products or systems, the user, through its own analysis and testing, is solely responsible for making the final selection of the products and systems and assuring that all performance, safety and warning requirements of the application are met.

The products described herein, including without limitation, product features, specifications, designs, availability and pricing, are subject to change by Parker Hannifin Corporation and its subsidiaries at any time without notice.

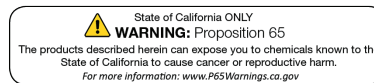

Basics of Coalescing Filtration

5

Compressed Air and Gas Filtration

HX Series, H Series, BA Series, ASME, WN Series

9

High Pressure and Alternative Fuel Filtration

M Series, FFC Series, J Series, A5R, A1R, S5R, S1R, S1L, SM, SJ, LPGR, LPGD Series

55

Instrumentation and Gas Sampling Filters

Stainless Steel, Aluminum, Plastic Filters, Disposable In-Line Filters

95

Dryers

FDD Desiccant Dryers, FMD Membrane Dryers

117

Par-Fit Conversion Elements

121

Drains, Gauges and Accessories

161

Offer of Sale

172

Facts and Conversions:

Pressure:

1 bar = 14.5 pounds per square inch (PSI)
 1 PSI = 27.686 inches of water (H₂O)
 1 PSI = 2.036 inches of Mercury (Hg)

Temperature:

32°Fahrenheit = 0° Celcius
 $^{\circ}\text{C} = (^{\circ}\text{F}-32)5/9$

Length:

1000 millimeters = 100 centimeters = 1 meter
 1 meter = 39.27 inches = 3.281 feet
 1 foot = 30.48 centimeters
 1 inch = 2.54 centimeters
 1 micron (μm) = 10^{-6} meters = one millionth of a meter
 25.4 μm = .001 inch

Volumetric Flow Rate:

1 cubic meter per second (m^3/s) = 2118.9 feet cubed per minute (ft^3/min)
 $1 \text{ ft}^3/\text{min} = 28.3 \text{ liters}/\text{min}$
 1 cubic meter per hour (m^3/hr) = 1.7 standard cubic feet per minute

Density:

$$\text{Density} = \frac{\text{Mass (m)}}{\text{Volume (V)}}$$

Mass:

1 pound = 453.59 grams = 0.45359 kilograms
 1 pound = 16 ounces
 1 ounce = 28.349 grams

Basics of Coalescing Filtration

Q. What is Coalescing filtration?

A. A steady state process whereby aerosols are caused to agglomerate (come together) into even larger droplets as they pass through the filter elements' fiber matrix, eventually becoming large enough to be gravitationally drained away.

Q. Why filter compressed air?

A. Submicronic contaminants in compressed air systems can:

- Plug orifices of sensitive pneumatic instrumentation
- Wear out seals
- Erode system components
- Reduce the absorptive capacity of desiccant air/gas dehydrators
- Foul heat transfer surfaces
- Reduce air tool efficiency resulting in:
 - Product rejects
 - Lost production time
 - Increased maintenance costs

For example, trace amounts of submicronic oil can cause serious fish eye blemishing in automotive finishing operations. Water left in air lines can freeze during exposure to cold, blocking flow or rupturing pipes.

Compressor lubricant not captured in a coalescing filter will eventually collect in pneumatic components, causing premature component repair or replacement. Environmental concerns will be raised if oily, compressed air is continually discharged into the atmosphere through a pneumatic muffler.

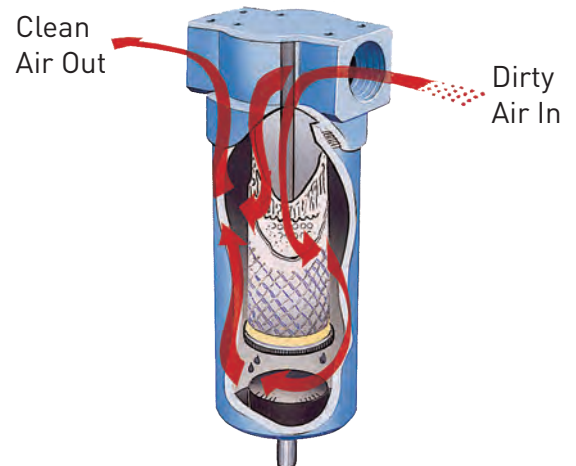

This filter housing cutaway depicts the coalescing process. Air enters the housing and flows through the filter media passing from the inside element surface to the outside. Coalesced liquid collects in the housing where it is drained, and clean air exits the housing through the outlet port.

Questions?

For more information about the basics of coalescing, request a free copy of Bulletin 1300-700/USA by calling 1-800-343-4048 or visit our website at: www.parker.com/igfg

This colorful 28-page handbook from Parker is intended to familiarize the user with all aspects of coalescing filtration, from the basics to advanced theory and concept.



Compressed Air Standards and Applications

From aeration in pharmaceutical and chemical processes to pneumatic power systems, the possibilities for applications are endless. Parker has some suggested air cleanliness standards that may fit your needs.

International Standard ISO8573-1 has become the industry standard method for specifying compressed air cleanliness. The following diagrams describe various systems in terms of their corresponding ISO classification.

ISO8573-1: 2010 CLASS	Solid Particulate			Mass Concentration mg/m ³	Water		Oil Total Oil (aerosol liquid and vapor) mg/m ³
	Maximum number of particles per m ³				Vapor Pressure Dewpoint	Liquid g/m ³	
	0.1 - 0.5 micron	0.5 - 1 micron	1 - 5 micron				
0	As specified by the equipment user or supplier and more stringent than Class 1						
1	≤ 20,000	≤ 400	≤ 10	-	≤ -94°F (-70°C)	-	0.01
2	≤ 400,000	≤ 6,000	≤ 100	-	≤ -40°F (-40°C)	-	0.1
3	-	≤ 90,000	≤ 1,000	-	≤ -4°F (-20°C)	-	1
4	-	-	≤ 10,000	-	≤ 37.4°F (3°C)	-	5
5	-	-	≤ 100,000	-	≤ 44.6°F (7°C)	-	-
6	-	-	-	≤ 5	≤ 50°F (10°C)	-	-
7	-	-	-	5 - 10	-	≤ 0.5	-
8	-	-	-	-	-	0.5 - 5	-
9	-	-	-	-	-	5 - 10	-
X	-	-	-	> 10	-	> 10	> 5

Note: The quality of the air delivered by non-lubricated compressors is influenced by the quality of the intake air and the compressor design.

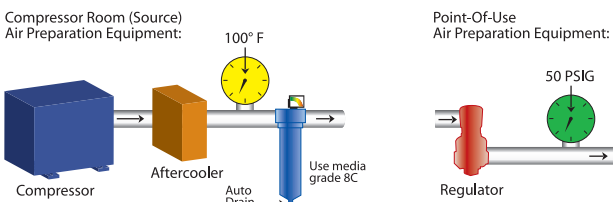

Any compressor with after-cooler. Air intended for use with lubricated air tools, air motors, cylinders, shot blasting, non-frictional valves.

OTHER SPECS MET: Compressed Air & Gas Institute CGA – G7.1 (Grades A & Ba1)

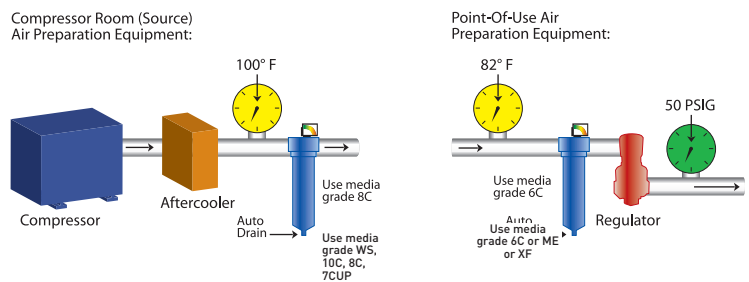

Any compressor with after-cooler, 2-stage coalescing. Air intended for use with lubricated control valves, cylinders, parts blow-down, etc.

OTHER SPECS MET: MIL-STD-282 HEPA, USPHS 3A Accepted particles for milk

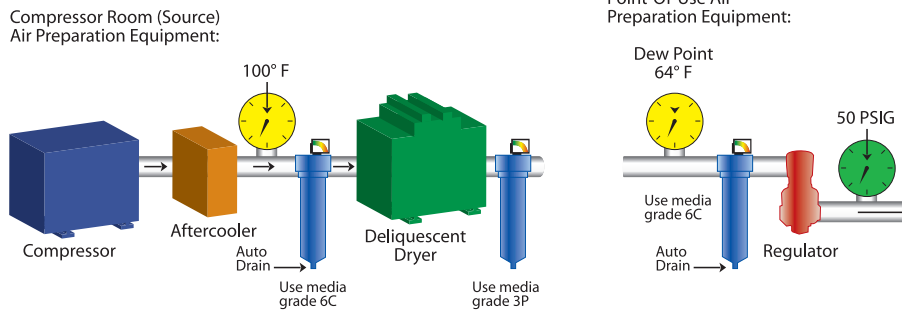

Any compressor with after-cooler, 2-stage coalescing and deliquescent dryer. Air intended for use with general pneumatic systems, body shop spray painting and components sensitive to high moisture content.

OTHER SPECS MET: Compressed Air & Gas Institute: CGA – G7.1 (Grade C)

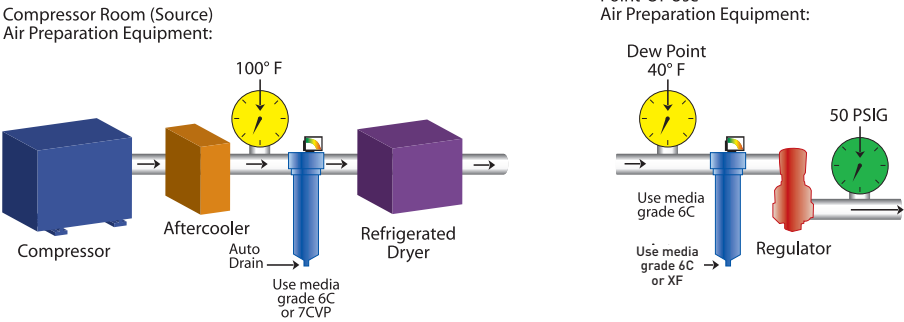

Any compressor with after-cooler, 2-stage refrigerated dryer. Air intended for use with air gauging, air conveyors, spray-painting, food processing, instrumentation, blow molding, cosmetics, film processing, bottling, pharmaceuticals, dairy, breweries, medical, robotics and close tolerance valves.

SPECS MET: CGA – G7.1 (Grades D & E), ISAS7.3 Fed. Std. 209 (Class 100)

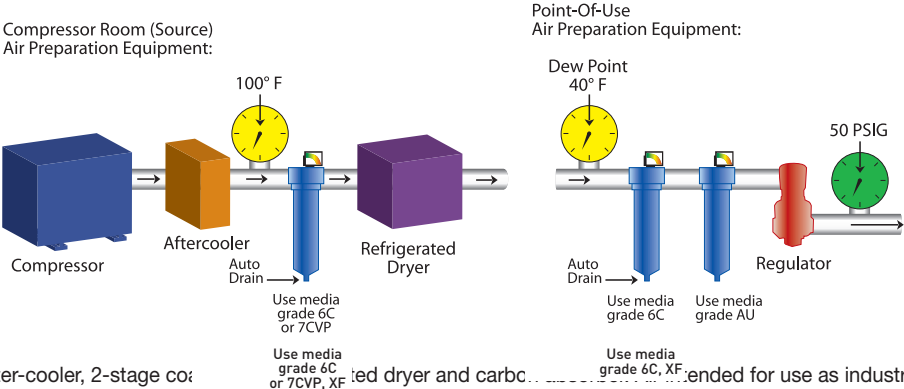

Any compressor with after-cooler, 2-stage compressed air system with a carbon canister and refrigerated dryer and carbon canister. Air intended for use as industrial breathing air and decompression chambers.

CAUTION: Always use high temperature synthetic lubricants and monitor (alarm for carbon monoxide concentrations). This system will not eliminate toxic gases!

OTHER SPECS MET: OSHA 29CFR 1910.134

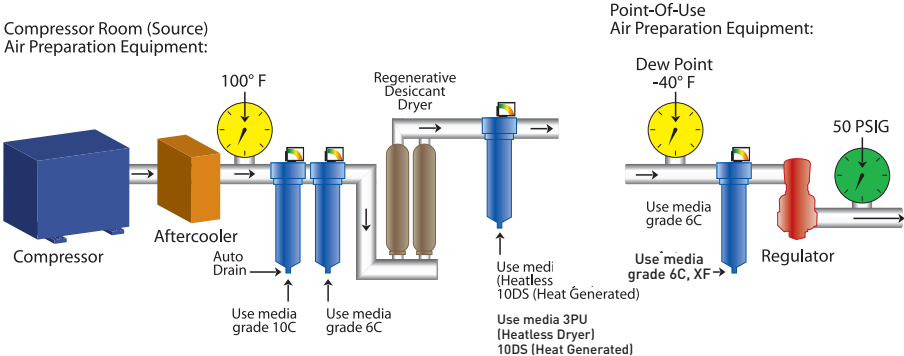

Any compressor with after-cooler, two-stage and double coalescing filter and a regenerative-type desiccant dryer. Air intended for use in applications involving rapid expansion of compressed air, critical instrumentation, high purity gases, computer chip drying, etc.

CAUTION: This air is too dry for respiratory use.

SPECS MET: CGA – G7.1 (Grade F)





HX-Series

High Efficiency Compressed Air Filters



ENGINEERING YOUR SUCCESS.

Why Filter Compressed Air?

Product rejects and increased maintenance expenses can occur due to poor air quality.

Submicronic contaminants in compressed air systems plug orifices of sensitive pneumatic instrumentation, wear out seals, erode system components, reduce the absorptive capacity of desiccant air/ gas dehydrators, foul heat transfer surfaces, reduce air tool efficiency, and damage finished products. The results include product rejects, lost production time and increased maintenance expense. For example, trace amounts of submicronic oil can cause serious fish eye blemishing in automotive

finishing operations. Water left in air lines can freeze during exposure to cold temperatures, blocking flow or rupturing pipes. Compressor lubricant not captured in a coalescing filter will eventually collect in pneumatic components, causing premature component failure, requiring repair or replacement. Environmental concerns will be raised if oily, compressed air is continually discharge into the atmosphere through a pneumatic muffler.

Finite's HX-Series Offers:

- Coalescing, bulk liquid removal, particulate, and adsorption filter elements
- Optional differential pressure gauge, an auto drain, or manual drain accessories
- Temperature to 212°F
- Pressures to 290 PSIG
- Connection sizes from 1/4" to 3" NPT
- Flows from 15 to 1300 SCFM



HX-Series by the numbers...

- 18 filter housing sizes
- 90 filter element types and sizes
- 10 connection sizes
- 9 filtration media choices: From bulk water separators to 99.995% efficient coalescers
- 2 unique nanofiber coalescing media technologies available, our time-tested UNI-CAST formulation as well as a deep bed pleated nanofiber choice
- 1,000,000s of borosilicate glass nanofibers utilized in each coalescing element made

Why Use Finite Filters?

Numerous Element Types

Our special UNI-CAST formed elements and our deep bed pleated elements provide lower pressure drop and less frequent changeouts, saving you time and money.

HX Meets Your Needs

The HX-Series offers 630 different filter/element variations to meet your application requirement

OEM Capabilities

When you need a special filter for a unique application, Parker Finite filter experts are ready to work with you. We can tailor a configuration to meet your special need from the wide variety of filter media available.

In addition, with LEAN manufacturing, we can produce specials in reasonable quantities, in a reasonable amount of time, at a reasonable price. Not only will this enhance the performance of your product, but it will benefit you with aftermarket sales of replacement elements.

Clean, energy efficient compressed air



The key is finding the optimum balance of compressed air quality required, and minimizing the cost and energy needed to achieve that quality.

ISO 8573-1:2010 is now the industry standard for specifying compressed air cleanliness. In this standard, three very common contaminants are focused on, and the various classes describe how clean and dry the compressed air must be in order to achieve that classification. Solid particle content by size range, water content by pressure dew point, and oil (including oil vapor) content in mg/m³ is described for each of the classes from Class 0, 1, 2, 3,...,9, and X. Class 0 is described as being as specified by the equipment user and is more stringent than Class 1. Even Class 1, because of its -94 °F (-70 °C) pressure dew point, is rarely required in general industrial settings. Most critical compressed air applications will probably fall into Class 2 described in the table below.

ISO 12500 establishes a uniform test procedure to be used by all filter companies in the compressed air industry. Using this test, air filters can be tested to equate their performance to ISO 8573-1:2010. This procedure specifies exactly how the filters should be tested at either of two inlet challenge levels: 10 mg/m³ or 40 mg/m³. Since high-efficiency filters are often plumbed in series or staged filtration, the pre-filters or pre-coalescers are often rated at the 40 mg/m³ level, and final or polishing coalescing filters are most often rated at the 10 mg/m³ level, since they are typically the beneficiary of pre-filtration.

Particulate contamination in a compressed air system can be drawn into the compressor through its intake, or be generated through the compression process or by other system components themselves. Water enters the system through the compressor's intake as humidity in the air. Once compressed the air is saturated meaning that depending on the environment of the system, the water is present either in liquid or vapor state. Oil and hydrocarbon vapors can be drawn into the compressor intake as well, but the largest contributor is carryover of compressor lubricant. See the chart below for typical carryover levels by compressor type.

Using a high performance filter to measure oil aerosol removal, these effects can be observed:

Customary remaining oil content of compressors		
30 ppm	Piston and mobile screw compressors	
12 ppm	Stationary screw compressors	
< 6 ppm	Rotary vane compressors	

Reference conditions 14.5 psi (a) (1 bar (a)), 68 °F (20 °C), 0% relative humidity.

ISO Standardization

International Standard ISO8573-1 has become the industry standard method for specifying compressed air cleanliness.

ISO8573-1: 2010 CLASS	Solid Particulate			Mass Concentration mg/m ³	Water		Oil Total Oil (aerosol liquid and vapor) mg/m ³
	Maximum number of particles per m ³				Vapor Pressure Dewpoint	Liquid g/m ³	
	0.1 - 0.5 micron	0.5 - 1 micron	1 - 5 micron				
0	As specified by the equipment user or supplier and more stringent than Class 1						
1	≤ 20,000	≤ 400	≤ 10	-	≤ -94°F (-70°C)	-	0.01
2	≤ 400,000	≤ 6,000	≤ 100	-	≤ -40°F (-40°C)	-	0.1
3	-	≤ 90,000	≤ 1,000	-	≤ -4°F (-20°C)	-	1
4	-	-	≤ 10,000	-	≤ 37.4°F (3°C)	-	5
5	-	-	≤ 100,000	-	≤ 44.6°F (7°C)	-	-
6	-	-	-	≤ 5	≤ 50°F (10°C)	-	-
7	-	-	-	5 - 10	-	≤ 0.5	-
8	-	-	-	-	-	0.5 - 5	-
9	-	-	-	-	-	5 - 10	-
X	-	-	-	> 10	-	> 10	> 5

HX-Series Filtration Technology

Our new HX-Series product line possesses many important design and construction features that combine to provide leading compressed air filtration performance. Improved flow characteristics result in lower pressure differential, which is related to the ongoing operating cost of employing high-efficiency nanofiber coalescing filters. They can be used in applications ranging from general shop air all the way up to those which call for extremely critical performance requirements, such as instrument air, breathing air, food and beverage or automotive assembly plant paint systems. The materials used in each filter assembly were chosen not only for compatibility with compressed air system environments, but also to provide a robust and trouble-free system component that can be relied on without worry. Additionally, these filters offer the optional accessory of modular connectors up through the one-inch connection size, enhancing their appeal for OEM usage.

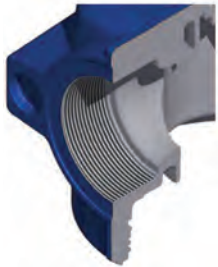

Inlet/Outlet Design

Each HX-Series assembly has an inlet and outlet design which provides a full-flow stream of air into and out of the housing. Connection sizes and flow rates correlate to capacities and connection sizes of various compressor types and sizes, reducing the need for bushings and adaptors.



Improved Flow Path

Patented aerospace inspired vanes in the neck of the replaceable filter element ensure unrestricted, turbulent-free laminar flow into the element's core with minimal pressure drop. This design provides no sharp edges or 90 degree elbow turns like traditional coalescing filters.

Flow Distribution

Flow through the core of the element is optimized by use of several features. A patented flow distributor, shown above left ensures that the flow entering the element's core is spread evenly about the inside of the element. At the element's base, a cone-shaped disperser prevents turbulence in the lower region (wet zone) of the element and redirects the air toward the filter media's surface.

Corrosion Protection

All HX-Series filter assemblies are constructed of cast aluminum. Each filter head and bowl is treated with an alocrome process that inhibits corrosion. They are also painted externally with an epoxy based powder paint which provides an extremely durable finish.



Conical Air Disperser

Air flow dispersion at the base of the element helps eliminate turbulence. See photo at left.

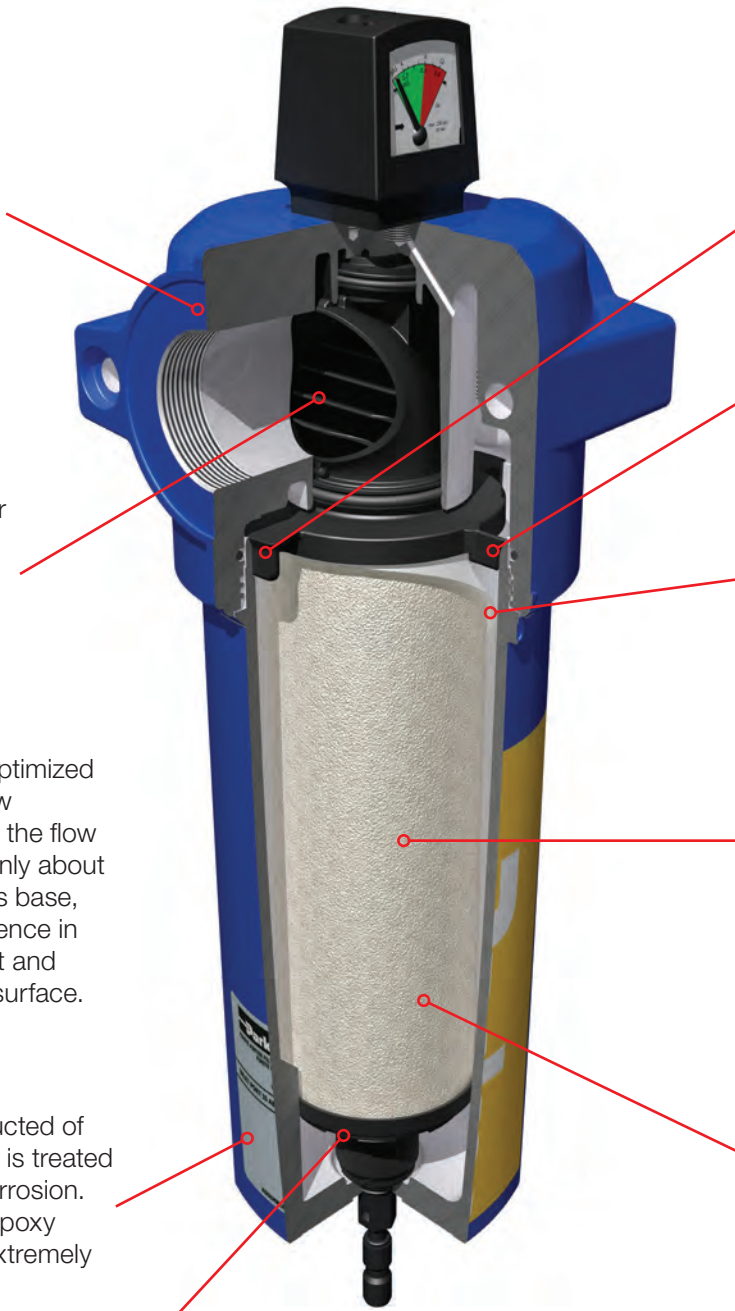



Inlet Port Indicators and Differential Sensing Port Plugs

Vertical hash marks are utilized on the top and bottom of the inlet connection port. This feature eliminates any confusion as to which port is the inlet. Although a differential pressure gauge is standard on all larger HX-Series housings, they are also available with threaded and plugged differential sensing ports which can be utilized to connect to remote or standardized monitoring equipment at your facility, or on your mobile equipment.



Patented Locating Tabs and External Flow Stabilizers

Each element possesses two locating tabs of differing size. This allows only one positive fit position into the filter bowl during maintenance, ensuring proper installation and eliminating any chance of mistake. Two external flow stabilizers also located on the element's top end cap are featured to provide an even flow of compressed air exhausting from the element into the housing's exit port.



Surge Shield

A shield is designed into the element on the exterior surface of the element, directly below from the outlet port. This shield is a safety barrier that eliminates any possibility of carryover during system upsets, when slugs of water might otherwise challenge the draining capability of coarser grade filter elements, especially water separators.



Deep Bed Pleated Nanofiber Filter Media

Parker's premium performance 7CP and XF media choices provide excellent filtration efficiency with industry leading low pressure differentials. Lower pressure drop equates to significant energy savings over time and the pleated element's larger surface area (up to 4.5 times) increases element life, providing even greater savings. 7CP (99.5%) is an excellent pre-coalescer choice while XF provides 99.95% efficiency for final-stage coalescing applications.



UNI-CAST Nanofiber Filter Media

Parker's unique UNI-CAST manufacturing process continues to provide time-tested and proven performance as only the industry's original cast media manufacturer can do. Seamless cast construction, with 95% void volumes and its graduated pore structure is available in four distinct grades with efficiencies ranging from 95% to 99.995% and micron ratings from 0.01 micron to 1.0 micron. This range enables them to be used in nearly any application as pre-coalescers as well as final, or polishing coalescers.

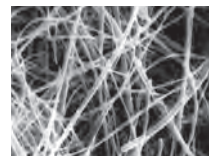

Typical Applications

Common applications for HX-Series filter elements

Compressed air, sometimes referred to as industry’s fourth utility, has a number of favorable aspects to its use. It is safe, light-weight, dependable, and because it is generated on site, the user has a great deal of control over the compressed air pressure available and its quality. Applications for compressed air are numerous and range from very simple to highly critical. High efficiency compressed air filters like Parker Finite’s HX-Series give the user a large array of filtration possibilities so that the user can pick the most effective for their particular applications. The list of applications below is not intended as a comprehensive listing, but as an overview of the many types of uses there are for the HX-Series product line.

HX-Series Applications			
Aeration	Dairy air	Oil vapor adsorption	Robotics
Air agitators	Dental hand pieces	Packaging	Sandblasting
Air bearings	Dental suction	Parts blow-offs	Snow-making
Air dryer pre-filters	Desiccant dryer after-filter	PET bottle blowing	Soot blowing
Air gauging	Dry bulk solid conveying	Plasma welding / cutting	Spray painting
Air hoists	Dust collection	Pneumatic automation	Sprinkler system
Air motors	Fermentation	Pneumatic conveying	charging
Air sparging	Filling / capping beverages	Pneumatic instruments	Tablet coating
Atomizing air	Injection molding	Pneumatic tools	Tire filling
Bag cleaning	Instrument air	Positioning / locating	Vacuum cups / grasps
Bottle filling	Liquid padding	Powder fluidizing	
Breathing air	Nitrogen separation	Pressure testing	
Cooling	Odor removal	Process air	

Compressed Air Standards and Applications

The five schematics shown below and on the following page show the major compressed air system components, where filters can be positioned, and the resulting compressed air quality specifications met (ISO 8573-1: 2010).

ISO Class 2 3	ISO Class 1 2
<p>Compressor Room (Source) Air Preparation Equipment:</p> <p>Compressor Aftercooler Auto Drain Use media grade 8C Regulator</p> <p>Point-Of-Use Air Preparation Equipment:</p> <p>50 PSIG</p>	<p>Compressor Room (Source) Air Preparation Equipment:</p> <p>Compressor Aftercooler Auto Drain Use media WS, 10C, 8C, 7CP Auto Drain Use media grade 6C, XF Regulator</p> <p>Point-Of-Use Air Preparation Equipment:</p> <p>100° F 82° F 50 PSIG</p>
<p>Any compressor with after-cooler. Air intended for use with lubricated air tools, air motors, cylinders, shot blasting, non-frictional valves.</p> <p>OTHER SPECS MET: CGA – G7.1 (Grades A & Ba1)</p>	<p>Any compressor with after-cooler and 2-stage coalescing. Air intended for use with lubricated control valves, cylinders, parts blow-down, etc.</p> <p>OTHER SPECS MET: Mil. Std. 282 H.E.P.A., U.S.P.H.S. 3A</p> <p>Accepted particles for milk</p>

ISO Class 1 4 2

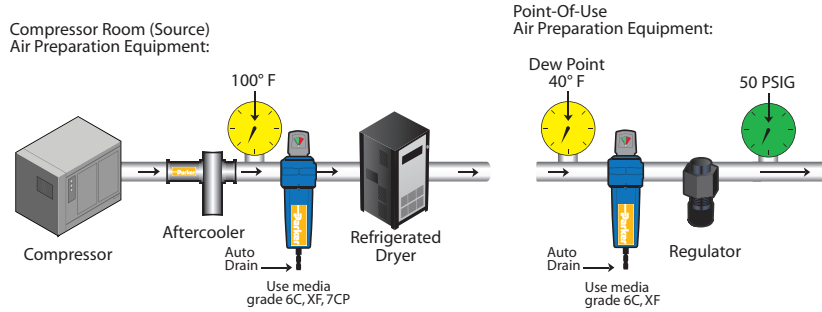

Any compressor with after-cooler, 2-stage coalescing and refrigerated dryer. Air intended for use with air gauging, air conveyors, spray-painting, food processing, instrumentation, blow molding, cosmetics, film processing, bottling, pharmaceuticals, dairy, breweries, medical, robotics and close tolerance valves.

SPECS MET: CGA – G7.1 (Grades D & E), ISAS7.3 Fed. Std. 209 (Class 100)

ISO Class 1 4 1

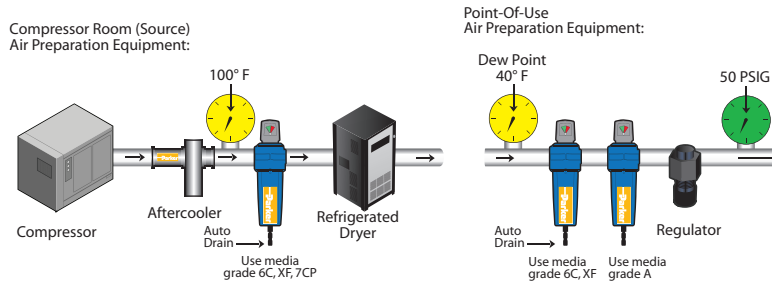

Any compressor with after-cooler, 2-stage coalescing, refrigerated dryer and carbon absorber. Air intended for use as industrial breathing air and decompression chambers. CAUTION: Always use high temperature synthetic lubricants and monitor (alarm for carbon monoxide concentrations). This system will not eliminate toxic gases!

OTHER SPECS MET: O.S.H.A. 29CFR 1910.134

ISO Class 1 2 1

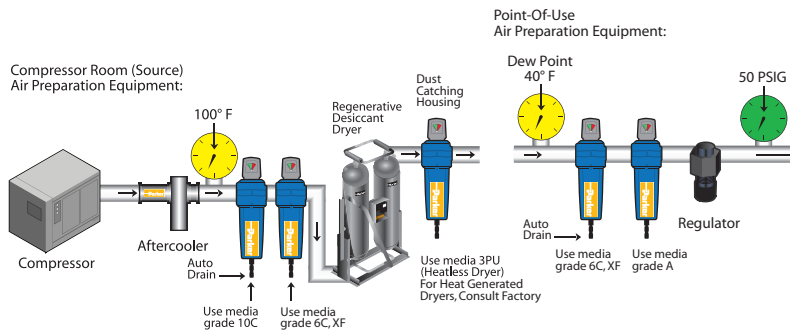

Any compressor with after-cooler, two-stage and double coalescing regenerative-type desiccant dryer and a carbon adsorber. Air intended for use in applications involving rapid expansion of compressed air, critical instrumentation, high purity gases, automotive paint systems, etc. CAUTION: This air is too dry for respiratory use.

Step 1. Determine your application, media grade and media type.

Choose media type from the descriptions below, from the basic application circuits on the previous page, or consult a Parker Finite application engineer. Decide the media grade from the bottom of the following page. If your application requires a coalescing element, use the information listed below. For other media types, please see the following page.

Coalescing Elements (removal of liquids and particulate)

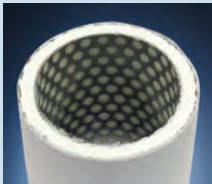

Media Type C

Available in grades 4, 6, 8, or 10
Air flow: Inside to outside

This coalescing element is made with our special UNI-CAST construction. Composed of an epoxy saturated borosilicate glass micro/ nanofiber media, this media is used in applications requiring the removal of liquid and particulate contamination. The outer synthetic fabric layer allows for swift removal of coalesced liquids.



Media Type 7CP or XF

Air flow: Inside to outside

Parker Finite's 7CP media type consists of two filter layers between metal retainers. The outer layer removes aerosols while the inner layer traps solid particles, protecting and extending the life of the outer layer. 7CP elements are used in bulk liquid coalescing applications or when relatively high efficiency and low pressure drop are required.

Parker Finite's XF media type are constructed similarly to the 7CP, but offer even higher filtration efficiency for more critical compressed air quality demands.

Choose a filter grade for media type C

Grade 4

Parker Finite's media grade 4 is typically chosen when an extremely high coalescing efficiency is required. Its 99.995% rating is the best available and is ideal for use as a final filter in applications with elevated operating pressures up to 290 PSIG. Grade 4's higher operating pressure drop can be reduced by oversizing. Consult factory.

Grade 6 (Standard)

Grade 6 filters are used when "total removal of liquid aerosols and suspended fines" is required. Because of its overall performance characteristics, this grade is most often recommended in a variety of industrial applications. Grade 6 is an excellent choice as a pre-filter for regenerative desiccant air dryers, as it prevents oil or varnish from coating the desiccant.

Grade 8

Grade 8 filters combine high efficiency (98.5%) with high flow rate and long element life. A separate pre-filter is not required for "normal to light" particulate loading. A grade 8 element is often chosen as protection for refrigerated air dryers. This element allows the dryer to maintain efficiency by preventing the coating of copper coils with the build-up of oil or varnish.

Grade 10

Grade 10 filters are used as pre-filters for grades 6 or 8 to remove gross amounts of liquid aerosols or tenacious aerosols. Grade 10 is often referred to as a coarse coalescer, or precoalescer. It is typically followed by a grade 6C final filter.

Water Separator Element
(removal of bulk liquids)

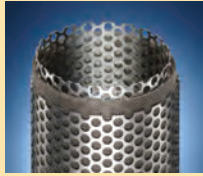

Media Type WS

Air Flow: Inside to outside

This rolled stainless steel mesh element has ID and OD metal retainers with rolled stainless steel mesh in between. It is an extremely robust design. With a nominal rating of 100 micron, this media is used for the reduction and elimination of excess liquids in gas streams. It also would be a good choice as a pre-filter for coalescing grades 6 and 10 when extreme volumes of liquid contaminants are present.

Particulate Removal Element
(removal of solids)

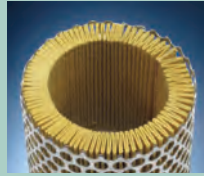

Media Type 3P

Air Flow: Inside to outside

Parker Finite's 3P pleated cellulose element removes solid contaminants, with a 3 micron absolute rating. Because this element is designed to flow from its inside to the outside, it has a strong outer retainer that gives this element added strength. 3P particulate "Interceptor" elements are used where very high dirt loading is expected but a relatively fine pore structure is required. It is also used as a pre-filter to a coalescing filter in systems where a lot of solid contamination exists.

Adsorption Element
(removal of odors)

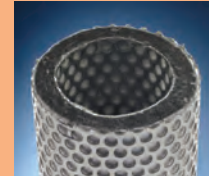

Media Type A

Air Flow: Inside to outside

This hydrocarbon vapor removal element consists of an ultra-fine grained, highly concentrated, activated carbon sheet media. Because these elements are designed to flow from the inside to their outside, they have a strong outer retainer giving this element added strength. This media type is used to remove hydrocarbon vapor and is often used to remove the smell or taste of compressor lube oil from breathing air. Maximum hydrocarbon inlet concentration .5 to 2 PPM.

Parker Finite Media Specifications

Media Grade	Coalescing Efficiency 0.3 to 0.6 Micron Particles	Micron Rating	Aerosol Content per ISO 12500-1	Maximum Oil Carryover (mg/m ³)	ISO Class*	Operating ΔP	Recommended Pre-filter
4C	99.995%	0.01	10	0.0005	1,_,2	5.4 - 6.7	10C or 7CP
6C	99.97%	0.01	10	0.003	1,_,2	3.0 - 4.0	10C or 7CP
XF	99.95%	0.3	10	0.05	1,_,2	1.5 - 2.0	7CP
7CP	99.5%	0.5	40	0.2	2,_,3	0.7 - 1.2	WS or 3P
8C	98.5%	0.5	40	0.6	2,_,3	1.0 - 1.4	WS or 3P
10C	95%	1.0	40	2	2,_,4	0.7 - 1.0	WS or 3P
WS	99+%	100	NA	NA	NA	0.7 - 1.2	NA
3P	N/A	3.0	NA	NA	3,_,_	0.7 - 1.2	NA
A	99+%	3.0	NA	NA	2,_,3	3.0 - 4.0	6C or XF

Note 1: Tested per ISO 12500-1 at specified inlet content.

Note 2: "*" Indicates suitability in accordance with ISO 8573-1:2010.

Note 3: Grades 4C, 6C, and XF could be used to achieve Class 1,_,1 if followed by a Grade A oil vapor adsorber.

Note 4: Bulk liquid removal efficiency is given for WS media.

Note 5: Oil vapor removal efficiency is given for A media.

Step 2. Determine your housing

Find your desired flow rate under the appropriate media grade column. For pressures other than 100 PSIG or temperatures other than 70°F, please see Alternate Housing Selection Chart, Step 2a.

Housing Selection Chart

Rated Flows: SCFM @ 100 PSIG; These flow rates can be exceeded by 10% and will still meet filtration efficiencies. For other pressures, please see Step 2a.

				Rated Flows (SCFM) at 100 PSIG Operating Pressure, 70°F Operating Temperature								
Housing Assembly	Media Grade	Accessory (see step 3)	Conn (NPT)	Final Stage Coalescers			Pre-Coalescers			Water Separation	Particulate	Vapors
				4C	6C	XF	7CP	8C	10C	WS	3P	A
HXN1A-	---	<input type="checkbox"/>	1/4"	15	15	20	20	15	15	15	15	15
HXN15B-	---	<input type="checkbox"/>	3/8"	35	35	40	40	35	35	35	35	35
HXN2B-	---	<input type="checkbox"/>	1/2"	35	35	40	40	35	35	35	35	35
HXN2BH-	---	<input type="checkbox"/>	1/2"	50	50	65	65	50	50	50	50	50
HXN3BH-	---	<input type="checkbox"/>	3/4"	50	50	65	65	50	50	50	50	50
HXN3C-	---	<input type="checkbox"/>	3/4"	100	100	125	125	100	100	100	100	100
HXN4C-	---	<input type="checkbox"/>	1"	100	100	125	125	100	100	100	100	100
HXN4D-	---	<input type="checkbox"/>	1"	180	180	230	230	180	180	180	180	180
HXN5D-	---	<input type="checkbox"/>	1-1/4"	180	180	230	230	180	180	180	180	180
HXN6D-	---	<input type="checkbox"/>	1-1/2"	180	180	230	230	180	180	180	180	180
HXN5E-	---	<input type="checkbox"/>	1-1/4"	320	320	340	340	320	320	320	320	320
HXN6E-	---	<input type="checkbox"/>	1-1/2"	320	320	340	340	320	320	320	320	320
HXN8E-	---	<input type="checkbox"/>	2"	320	320	340	340	320	320	320	320	320
HXN8F-	---	<input type="checkbox"/>	2"	430	430	465	465	430	430	430	430	430
HXN8G-	---	<input type="checkbox"/>	2"	540	540	700	700	540	540	540	540	540
HXN10H-	---	<input type="checkbox"/>	2-1/2"	650	650	900	900	650	650	650	650	650
HXN12H-	---	<input type="checkbox"/>	3"	650	650	900	900	650	650	650	650	650
HXN12J-	---	<input type="checkbox"/>	3"	900	900	1300	1300	900	900	900	900	900

Step 2a. Alternate Housing Selection Chart

Use this step for applications that do not have standard conditions (100 PSIG and 70°F).

Converting Actual Application Conditions to Standardized Conditions

Because the required size of a filter is affected not only by flow, but also by operating pressure and operating temperature, it is necessary to convert those actual conditions to standardized conditions (100 PSIG and 70°F). The calculated adjusted flow rate can then be used to choose the appropriate filter in the chart on the previous page. When using the chart, choose the closest flow rate from the appropriate media grade column.

NOTE: HX-Series filters are designed for use with compressed air and inert gases such as nitrogen. It cannot be used with flammable or poisonous gases.

Gas	Specific Gravity
Air	1.00
Argon	1.37
Carbon Dioxide	1.52
Carbon Monoxide	0.96
Neon	0.69
Nitrogen	0.96

Note: Take the square root of your specific gravity. If this is for a compressed air application, skip this step because the specific gravity of air equals one. Please see chart to the left for specific gravities.

Refer to this chart if you do not know the specific gravity of the gas you are filtering.

Equation for Adjusted Flow Rate

Flow Rate:	Pressure:	Temperature:	Specific Gravity:	Adjusted Flow Rate:
Actual System Flow Rate (SCFM)	$\times \frac{(100 \text{ PSIG} + 14.7 \text{ PSIG})}{(\text{System Pressure (PSIG)} + 14.7 \text{ PSIG})}$	$\times \frac{(70^\circ\text{F} + 460^\circ\text{F})}{(\text{System Temp. } ^\circ\text{F} + 460^\circ\text{F})}$	$\times \sqrt{\frac{1.0 \text{ (specific gravity of gas)}}{\text{specific gravity of gas}}}$	$= \frac{\text{SCFM}}{(\text{@ } 100 \text{ PSIG, and } 70^\circ\text{F})}$

Example

Your compressed air application requires a Media Grade 6 Coalescer Filter. The actual flow rate is 136 SCFM, an actual pressure of 150 PSIG, and an actual temperature of 100°F.

$$136 \text{ SCFM} \times \frac{(150 \text{ PSIG} + 14.7 \text{ PSIG})}{(100 \text{ PSIG} + 14.7 \text{ PSIG})} \times \frac{70^\circ\text{F} + 460^\circ\text{F}}{(100^\circ\text{F} + 460^\circ\text{F})} \times 1 = 100 \text{ SCFM}$$

Return to the Housing Selection Chart on the previous page. Using the given information and the result from the above equation, you will look for the “Grade 6C” column heading. In this column you will find that the correct housing assembly for a 100 SCFM flow rate would be the **HXN3C or HXN4C** model, depending on your NPT connection.

Step 3. Accessories

Choose your accessories. Please consult Parker Finite when choosing pre-installed accessories for gases other than air.

Pre-installed Accessories

Accessory Designator	Accessory Type	Maximum Pressure	Maximum Temperature	Standard / Optional
N	Manual Drain	290 psi g	212°F	Optional on all model sizes
A	Auto Drain	250 psi g	175°F	Standard on all model sizes
G	DP Gauge + Manual Drain	230 psi g	175°F	Optional on models HXN15B-HXN4C
Y	Auto Drain and DP Gauge	230 psi g	175°F	Standard on models HXN4D-HXN12J

Replacement Accessories



	Differential Pressure Gauge 2198HX	Manual Drain 2205HX	Auto Drain Valve 2206HX
Fits Filter Size	HXN15B - HXN12J	HXN1A - HXN12J	HXN1A - HXN12J
Description	Mounts on ports on head; bilateral display	1/2" NPT	Includes 5/16" tube union

Note: Auto drains require a minimum operating pressure of 10 PSIG to seal.

Other Compatible Drain Accessories



	TV-50 Timed Drain Valve	ZLD-013 Zero Loss Drain	VS-50 Visual Sump Drain (not shown: standard bowl guard)	MS-50 Metal Sump Drain (External)
Temperature	210° F (99° C)	140° F (60° C)	125° F (52° C)	175° F (79° C)
Pressure	300 PSIG (20 Bar)	232 PSIG (16 Bar)	150 PSIG (10 Bar)	250 PSIG (17 Bar)
Port Size	1/2" NPT	1/2" NPT	1/2" NPT	1/2" NPT

Note: The accessories above are compatible with this product line, however, they are sold separately. Other timed drain valves can be found in the Air Line Filtration Accessories section.

Step 4. How to Order

HX Series Filter Assemblies

HX Series Name	N Port Type	3 Port (Connection) Size	C Bowl	6 Element Grade	C Element Type	Y Accessory Designator for pre-installed accessories	
HX	N - NPT	1 - 1/4"	A	4	C	N - No Accessories, Manual Drain (optional on all model sizes). A - Auto Drain (optional on all model sizes). G - Differential Pressure Gauge (gauge not available on model HXN1A) and manual drain. Y - Auto Drain and Differential Pressure Gauge (optional on models HXN4D - HXN12J).	
		15 - 3/8"	B	6			
		2 - 1/2"	B, BH	8			
		3 - 3/4"	BH, C	10			
		4 - 1"	C, D	7			CP
		5 - 1/4"	D, E	X			F
		6 - 1/2"	D, E	W			S
		8 - 2"	E, F, G	3			P
		0 - 2 1/2"	H	A			
		12 - 3"	H, J				

Examples: HXN1A-6CN, HXN2BH-WSA, HXN12J-XFY, HXN8G-6CG

HX Series Replacement Elements

The kit includes the replacement element with o-rings, the head-to-bowl o-ring, and lubricant.

Element Type	Series	Bowl Size	Kit
6C	HX	C	K
4C	HX	A	K = Kit
6C		B	
8C		BH	
10C		C	
7CP		D	
XF		E	
WS		F	
3P		G	
A		H	
		J	



Examples: 6CHXAK, WSHXBHK, XFHXJK, 6CHXGK

Replacement Element Part Numbers

Housing Assembly	Conn (NPT)	4C	6C	XF	7CP	8C	10C	WS	3P	A
HXN1A-	1/4"	4CHXAK	6CHXAK	XFHXAK	7CPHXAK	8CHXAK	10CHXAK	WSHXAK	3PHXAK	AHXAK
HXN15B-	3/8"	4CHXBK	6CHXBK	XFHXBK	7CPHXBK	8CHXBK	10CHXBK	WSHXBK	3PHXBK	AHXBK
HXN2B-	1/2"									
HXN2BH-	1/2"	4CHXBHK	6CHXBHK	XFHXBHK	7CPHXBHK	8CHXBHK	10CHXBHK	WSHXBHK	3PHXBHK	AHXBHK
HXN3BH-	3/4"									
HXN3C-	3/4"	4CHXCK	6CHXCK	XFHXCK	7CPHXCK	8CHXCK	10CHXCK	WSHXCK	3PHXCK	AHXCK
HXN4C-	1"									
HXN4D-	1"	4CHXDK	6CHXDK	XFHXDK	7CPHXDK	8CHXDK	10CHXDK	WSHXDK	3PHXDK	AHXDK
HXN5D-	1-1/4"									
HXN6D-	1-1/2"	4CHXEK	6CHXEK	XFHXEK	7CPHXEK	8CHXEK	10CHXEK	WSHXEK	3PHXEK	AHXEK
HXN5E-	1-1/4"									
HXN6E-	1-1/2"	4CHXFK	6CHXFK	XFHXFK	7CPHXFK	8CHXFK	10CHXFK	WSHXFK	3PHXFK	AHXFK
HXN8E-	2"									
HXN8F-	2"	4CHXGK	6CHXGK	XFHXGK	7CPHXGK	8CHXGK	10CHXGK	WSHXGK	3PHXGK	AHXGK
HXN8G-	2"									
HXN10H-	2-1/2"	4CHXHK	6CHXHK	XFHXHK	7CPHXHK	8CHXHK	10CHXHK	WSHXHK	3PHXHK	AHXHK
HXN12H-	3"									
HXN12J-	3"	4CHXJK	6CHXJK	XFHXJK	7CPHXJK	8CHXJK	10CHXJK	WSHXJK	3PHXJK	AHXJK

Examples on How to Order:

Example 1:

HXN1A-6CN

What am I ordering?

An HX-Series with a 1/4" NPT connection, A-size bowl, a standard grade 6 coalescing element with no accessories, manual drain only.

Example 2:

6CHXAK

What am I ordering?

An HX-Series replacement element kit, a grade 6 coalescing element, for an A-size bowl. This kit includes the replacement element with o-ring, head-to-bowl o-ring and lubricant.

Example 3:

HXN12J-XFY

What am I ordering?

An HX-Series with a 3" NPT connection with a J-size bowl, an XF coalescing element with a Y accessory option which includes an auto drain and differential pressure gauge.

Example 4:

XFHXJK

What am I ordering?

An HX-Series replacement element kit, with an XF coalescing element for a J-size bowl. The kit includes the replacement element with o-rings, the head-to-bowl o-ring and lubricant.

Drawings, Dimensions, and Specifications

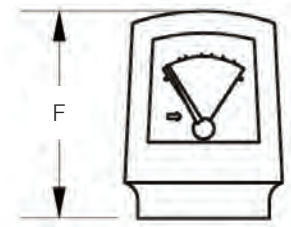
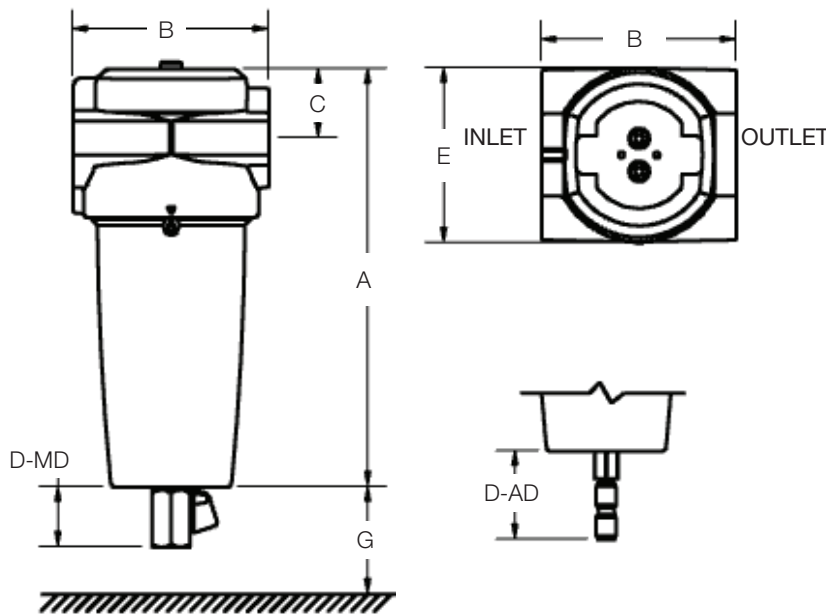

Additional Accessories Available

Specifications

(Pressure/Temp vary by accessory. See Step 3.)

Max. Pressure:	230 psig - 290 psig
Safety Factor:	Burst to max. operating pressure 4:1
Max. Temp:	212°F
Seals:	Element: Nitrile Head to bowl: Nitrile
Materials:	Head: Aluminum Bowl: Aluminum
Coatings:	Alocromed heads and bowls Dry powder epoxy paint

Weights and Dimensions

Model No.	Conn. (NPT)	A (in.)	B (in.)	C (in.)	D-MD (in.)	D-AD (in.)	E (in.)	F (in.)	G (in.)	Sump (oz.)	Wt. (lbs.)
HXN1A-	1/4"	7.0	2.6	0.9	1.6	2.4	2.6	N/A	1.2	2.7	1.4
HXN15B-	3/8"	9.4	3.5	1.5	1.6	2.4	3.4	2.7	1.9	7.4	3.1
HXN2B-	1/2"	9.4	3.5	1.5	1.6	2.4	3.4	2.7	1.9	7.4	3.1
HXN2BH-	1/2"	9.4	3.5	1.5	1.6	2.4	3.4	2.7	1.9	4.4	3.1
HXN3BH-	3/4"	9.4	3.5	1.5	1.6	2.4	3.4	2.7	1.9	4.4	3.1
HXN3C-	3/4"	10.9	5.1	1.8	1.6	2.3	4.6	2.7	2.6	8.6	6.3
HXN4C-	1"	10.9	5.1	1.8	1.6	2.3	4.6	2.7	2.6	8.6	6.3
HXN4D-	1"	14.5	5.1	1.8	1.6	2.3	4.6	2.7	2.6	7.4	7.2
HXN5D-	1-1/4"	14.5	5.1	1.8	1.6	2.3	4.6	2.7	2.6	7.4	7.2
HXN6D-	1-1/2"	14.5	5.1	1.8	1.6	2.3	4.6	2.7	2.6	7.4	7.2
HXN5E-	1-1/4"	17.3	6.5	2.2	1.6	2.4	6.2	2.7	3.9	12.8	9.5
HXN6E-	1-1/2"	17.3	6.5	2.2	1.6	2.4	6.2	2.7	3.9	12.8	9.5
HXN8E-	2"	17.3	6.5	2.2	1.6	2.4	6.2	2.7	3.9	12.8	9.5
HXN8F-	2"	20.9	6.5	2.2	1.6	2.4	6.2	2.7	3.9	12.3	15.9
HXN8G-	2"	27.7	6.5	2.2	1.6	2.4	6.2	2.7	3.9	11.1	19.9
HXN10H-	2-1/2"	25.7	7.6	2.8	1.7	2.4	7.2	2.7	4.7	22.0	26.9
HXN12H-	3"	25.7	7.6	2.8	1.7	2.4	7.2	2.7	4.7	22.0	26.9
HXN12J-	3"	33.2	7.6	2.8	1.7	2.4	7.2	2.7	4.7	22.0	31.0

Aftermarket Accessories and Spare Parts

Modular Connectors and Mounting Bracket Kits

(includes mounting brackets, threaded rods, hex flange locknuts, and gaskets if necessary)

Part Number	Filter Size	Includes
2207HX	HXN1A - 1 Housing	2 brackets, 2 threaded rods, 4 flanged lock nuts
2208HX	HXN1A - 2 Housings	2 brackets, 2 threaded rods, 4 flanged lock nuts, 1 gasket
2209HX	HXN1A - 3 Housings	2 brackets, 2 threaded rods, 4 flanged lock nuts, 2 gaskets
2210HX	HXN15B - HXN3BH - 1 Housing	2 brackets, 2 threaded rods, 4 flanged lock nuts
2211HX	HXN15B - HXN3BH - 2 Housings	2 brackets, 2 threaded rods, 4 flanged lock nuts, 1 gasket
2212HX	HXN15B - HXN3BH - 3 Housings	2 brackets, 2 threaded rods, 4 flanged lock nuts, 2 gaskets
2213HX	HXN3C -HXN6D - 1 Housing	2 brackets, 2 threaded rods, 4 flanged lock nuts
2214HX	HXN3C -HXN6D - 2 Housings	2 brackets, 2 threaded rods, 4 flanged lock nuts, 1 gasket
2215HX	HXN3C -HXN6D - 3 Housings	2 brackets, 2 threaded rods, 4 flanged lock nuts, 2 gaskets

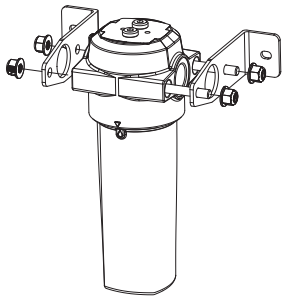

Example shown: 2210HX,
1 housing with mounting brackets

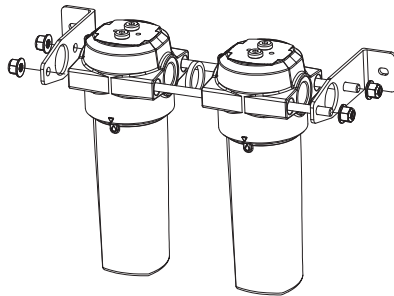

Example shown: 2211HX,
2 housings with modular connector
and mounting brackets

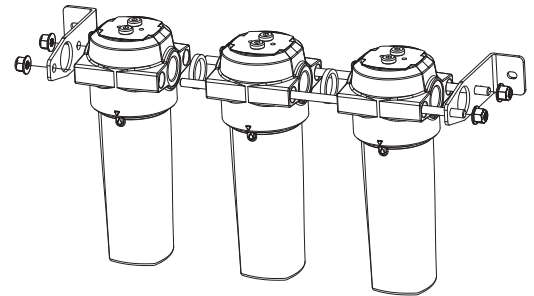

Example shown: 2212HX,
3 housings with modular connector
and mounting brackets

Seal Kits

(includes o-ring and lubricant)

Part Number	Includes
2200HX	Head-to-bowl o-ring kit for model HXN1A
2201HX	Head-to-bowl o-ring kit for models HXN15B - HXN3BH
2202HX	Head-to-bowl o-ring kit for models HXN3C - HXN6D
2203HX	Head-to-bowl o-ring kit for models HXN5E - HXN8G
2204HX	Head-to-bowl o-ring kit for models HXN10H - HXN12J

Other Spare Parts

Part Number	Includes
2199HX	DP Hardware Kit (includes 2 gaskets and 2 screws only)
2220HX	DP Plug Kit (includes 2 DP plugs, 2 gaskets)

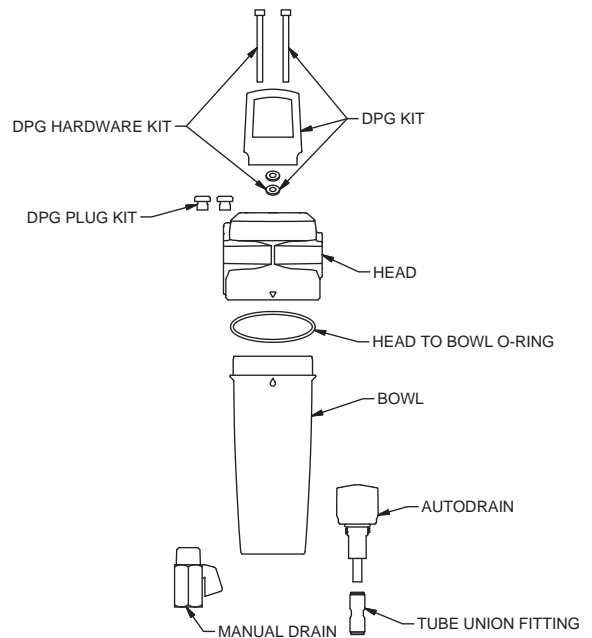



Superior Design and Construction

Our UNI-CAST nanofiber filters, formed with a unique vacuum process, combine surface (edge) filtration with enhanced depth filtration. UNI-CAST pore construction traps larger poreclogging particles on the surface while allowing access to the element's internal fiber matrix for coalescing and submicronic particulate removal. The result is lower pressure drop and less frequent change-outs saving you time and money. Our deep bed pleated nanofiber filters offer even lower pressure drop performance coupled with excellent capture efficiencies.

Outstanding Technical Assistance

We are committed to providing unmatched technical support to all our customers. Our degreed application engineers provide immediate response to technical questions and requests for specifications and quotes whenever possible. If they are busy serving other customers when you call, they make every effort to return your call within the hour.



Superior, Consistent Performance

Superior, consistent performance is as vital to your operation as it is to ours. Certified to ISO 9001:2008 and ISO 14001:2004 Environmental Management Standard, our quality management systems provide products that meet your filtration requirements and exceed your performance expectations. Combined with our superior filter design, Parker filters produce lower differential pressures and higher dirt-holding capacity. Offered in a variety of efficiencies, the media you select will fit your filtration needs.





H-Series

High Efficiency Coalescing Filters



ENGINEERING YOUR SUCCESS.

Why Filter Compressed Air?

Product rejects and increased maintenance expenses can occur due to poor air quality

Submicronic contaminants in compressed air systems plug orifices of sensitive pneumatic instrumentation, wear out seals, erode system components, reduce the absorptive capacity of desiccant air/ gas dehydrators, foul heat transfer surfaces, reduce air tool efficiency, and damage finished products.

The results include product rejects, lost production time and increased maintenance expense. For example, trace amounts of submicronic oil can cause serious fish eye blemishing in automotive finishing operations.

Water left in air lines can freeze during exposure to cold temperatures, blocking flow or rupturing pipes.

Compressor lubricant not captured in a coalescing filter will eventually collect in pneumatic components, causing premature component repair or replacement. Environmental concerns will be raised if oily, compressed air is continually discharged into the atmosphere through a pneumatic muffler.



Parker Finite filters are used everyday in food grade applications.

The H-Series Offers:

- Coalescing, particulate and adsorption filter elements
- Optional indicators, gauges and drains
- Temperatures to 450° F (232°C)
- Pressures to 500 PSIG (34 bar)
- Connection sizes from 1/4" to 3" NPT, BSPP & BSPT
- Flows from 10 to 1660 SCFM (17-2822 m3/hr)
- CRN approved in all Canadian Provinces

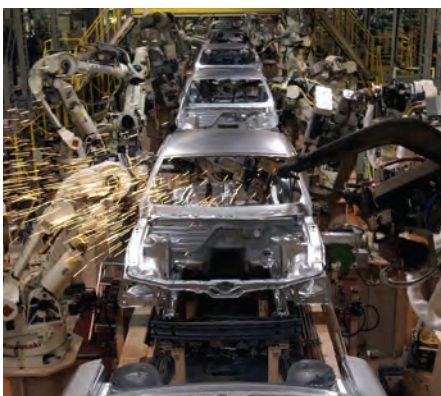

Manufacturing plants use compressed air in a variety of automated processes.

Why Use Parker Finite?

Element formation

Our special UNI-CAST formed elements provide lower pressure drop and less frequent change-outs, saving you time and money.

We meet your needs

Parker offers a variety of filter elements to meet your application requirements.

Technical support

We are committed to providing unmatched technical support to all of our customers.

Short lead times

Our LEAN manufacturing capability assures that you will have the right filter product at the right time. Popular products are shipped in three days.



Typical Applications

Common applications for H-Series filter elements

Coalescing (Oil Removal)	Interceptor (Particulate Removal)	Adsorber (Vapor Removal)
Air dryer pre-filter	Desiccant dryer after-filter	Odor removal
Paint spray booths	Pre-filter for coalescer	Breathing air
Breathing air	Systems with high concentrations of solid contaminant	Food packaging equipment
Tool protection	Particulate protection for non-lubricated systems	High purity laboratory gases
Air valve protection		Hydrocarbon vapor removal
Air cylinder protection		
Natural gas filtration		
Technical gas filtration		

4 Steps to Clean, Dry Compressed Air and Gas:

Step 1: Determine your application, media grade, media type and end seal material

Step 2: Choose your housing and replacement elements

Step 3: Choose your accessories

Step 4: How to Order

Note: See pages 14-15 for application and system schematics

Sources of Contamination

Compressed air and gas lines typically contain water, oil and particulate contamination

The contaminants of greatest concern in precision compressed air systems are water, oil and solids.

Water vapor is present in all compressed air and it becomes greatly concentrated by the compression process. While air dryer systems can be used effectively to remove water from compressed air, they will not remove the second major liquid contaminant - oil.

Most oil comes from compressor lubrication carry-over, but even the air produced by oil-free compressors has hydrocarbon contamination brought into the system through the intake.

The third contaminant is solid matter including dirt, rust and scale. Solid particulates, combined with aerosols of water and oil, can clog and shorten the life of air system components and can foul processes.

Step 1. Determine your application, media grade, media type and end seals.

Find your (or similar) application from the descriptions below, from the basic application circuits on the previous page, or consult one of our application engineers. Determine media grade, media type and end seal required. If your application requires a coalescing element, use the information listed below. For other media types, please see the following page.

Coalescing Elements (removal of liquids and particulate)



Media Type C or I
Available in grades 4, 6, 8, 10

Air flow: Inside to outside

This coalescing element is made with our special UNI-CAST construction. Composed of an epoxy saturated borosilicate glass micro-fiber media, this media is used in applications requiring the removal of liquid and particulate contamination. The outer synthetic fabric layer allows for swift removal of coalesced liquids.

Media type I is constructed similarly to the C media but also includes an inner retainer intended for additional strength where reverse flow is likely.

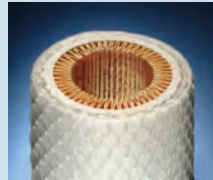

Media Type Q
Available in grades 4, 6, 8, 10

Air flow: Inside to outside

This coalescing element is composed of an epoxy saturated, borosilicate glass micro-fiber media, and is also made with our special UNI-CAST construction. This media type has a built-in pleated cellulose pre-filter as the inner layer. As with the C and I media types, the outer synthetic fabric layer aids in the swift and efficient removal of coalesced liquids.

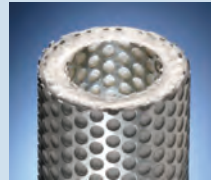

Media Type D
Available in grades 4, 6, 8, 10

Air flow: Inside to outside

Media type D elements are composed of a micro-glass coalescer, utilize a special high temperature UNI-CAST formulation, but are surrounded by inner and outer diameter metal retainers. These metal retainers, coupled with a glass drain layer, make this an extremely robust element designed to remove both solid and liquid contaminants at elevated temperatures.

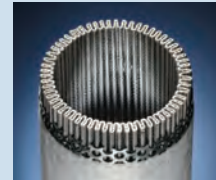

Media Type 7CVP, 7DVP, or ME (Available in 1¼" NPT port size housings and larger)

Air flow: Inside to outside

Parker Finite's 7CVP media type consists of two filter layers between metal retainers. The outer layer removes aerosols while the inner layer traps solid particles, protecting and extending the life of the outer layer. 7CVP elements are used in bulk liquid coalescing applications or when relatively high efficiency and low pressure drop are required. A special 7DVP media is constructed the same way, however it allows for higher temperature applications.

Parker's ME media type are mist eliminator elements that are constructed similarly to the 7CVP, but offer even higher filtration efficiency for more critical compressed air quality demands.

Choose a filter grade for media types C, I, Q, or D

Grade 4

Parker's media grade 4 is typically chosen when an extremely high coalescing efficiency is required. Its 99.995% rating is the best available and is ideal for use as a final filter in applications with elevated operating pressures (up to 500 PSIG), or when removing liquid contaminants from gases lighter than compressed air.

Grade 6 (Standard)

Grade 6 filters are used when "total removal of liquid aerosols and suspended fines" is required. Because of its overall performance characteristics, this grade is most often recommended in a variety of industrial applications. Grade 6 is an excellent choice as a pre-filter for regenerative desiccant air dryers, as it prevents oil or varnish from coating the desiccant.

Grade 8

Grade 8 filters combine high efficiency (98.5%) with high flow rate and long element life. A separate pre-filter is not required for "normal to light" particulate loading. A grade 8 element is often chosen as protection for refrigerated air dryers. This element allows the dryer to maintain efficiency by preventing the coating of copper coils with the build-up of oil or varnish.

Grade 10

Grade 10 filters are used as pre-filters for grades 6 or 8 to remove gross amounts of liquid aerosols or tenacious aerosols. Grade 10 is often referred to as a coarse coalescer, or pre-coalescer. A grade 10 in a media type D filter element is recommended as an after-filter for heat regenerated desiccant type air dryers as its one micron rating is ideal for collecting air dryer desiccant fines before they pass downstream.

Water Separator Element (removal of bulk liquids)



Media Type 100WS

Air Flow: Inside to outside

This rolled stainless steel mesh element has ID and OD metal retainers with rolled stainless steel mesh in between. It is an extremely robust design. With a nominal rating of 100 micron, this media is used for the reduction and elimination of excess liquids in gas streams. It also would be a good choice as a pre-filter for coalescing grades 6 and 10 when extreme volumes of liquid contaminants are present.

Particulate Removal Element (removal of solids)



Media Type 3P

Air Flow: Outside to inside

Parker's 3P pleated cellulose element removes solid contaminants, with a 3 micron absolute rating. Because this element is designed to flow from its outside to the inside, it has a strong inner retainer that gives this element added strength. 3P particulate "Interceptor" elements are used where very high dirt loading is expected but a relatively fine pore structure is required. It is also used as a pre-filter to a coalescing filter in systems where a lot of solid contamination exists.

Adsorption Element (removal of odors)



Media Type A

Air Flow: Outside to inside

This hydrocarbon vapor removal element consists of an ultra-fine grained, highly concentrated, activated carbon sheet media. Because these elements are designed to flow from the outside to their inside, they have a strong inner retainer giving this element added strength. This media type is used to remove hydrocarbon vapor and is often used to remove the smell or taste of compressor lube oil from breathing air. Maximum hydrocarbon inlet concentration .5 to 2 PPM.

Parker Finite Media Specifications

Media Grade	Coalescing Efficiency 0.3 to 0.6 Micron Particles	Maximum Oil Carryover ¹ PPM w/w	Micron Rating	Pressure Drop (PSID) @ Rated Flow ²	
				Media Dry	Media Wet ⁵
4	99.995%	0.003	0.01	1.25	3-4
6	99.97%	0.008	0.01	1.0	2-3
ME	99.95%	0.02	0.3	0.5	1.0
7	99.5%	0.09	0.5	0.25	0.5-0.7
8	98.5%	0.2	0.5	0.5	1-1.5
10	95%	0.85	1.0	0.5	0.5
100WS	99+% ³	N/A	100	< 0.25	< 0.25
3P	N/A	N/A	3.0	0.25	N/A
A	99+% ⁴	N/A	3.0	1.0	N/A

¹Tested per ISO 12500-1 at 40 ppm inlet.

²Add dry + wet for total pressure drop.

³Bulk liquid removal efficiency.

⁴Oil vapor removal efficiency is given for A media.

⁵Media wet with 10-20 wt. oil.

End Seals Available:

End Seals	Available on Media Type	Max temp of Element with End seal
No end seals — Element is self sealing. Standard on filters with 1/4" to 1" connection sizes.	C	175°F (79°C)
U: Molded Urethane, Standard on all filters with 1 1/4" to 3" connection sizes.	C	175°F (79°C)
	I	175°F (79°C)
	Q	175°F (79°C)
	3P	175°F (79°C)
	100WS	175°F (79°C)
S: Molded silicone rubber end seals used for high temperature elements up to 450°F (232°C).	A	175°F (79°C)
	C	175°F (79°C)
	Q	175°F (79°C)
	D	450°F (232°C)
V: Fluorocarbon gaskets bonded to metal end caps.	3P	350°F (177°C)
	C	350°F (177°C)
	D	450°F (232°C)
	ME	175°F (79°C)
	7CVP	175°F (79°C)
	7DVP	400°F (204°C)
	100WS	450°F (232°C)
3P	350°F (177°C)	
A	175°F (79°C)	

Note: V option is only available on 1/4" NPT and larger. Standard on all 7CVP, 7DVP, and ME media.

Step 2. Determine your housing

Find your desired flow rate under the appropriate media grade column. For pressures other than 100 PSIG or temperatures other than 70°F, please see Alternate Housing Selection Chart, Step 2a, on following page.

Note: The housing assembly part numbers below have a NPT connection. For BSPP, insert F in place of N. For BSPT, insert T in place of N.

Housing Selection Chart

Rated Flows: SCFM @ 100 PSIG (m³/hr @ 7 bar). For other pressures, please see Step 2a on following page.

Housing Assembly	Port Size	Grade 4 Coalescer	Grade 6 Coalescer (Standard)	Grade 7CVP Coalescer (or ME Media)	Grade 8 Coalescer	Grade 10 Coalescer	Grade 3PU Particulate Removal	Grade 100WS Water Separator	Grade A Adsorber
HN1S	1/4"	11 (19)	15 (26)	N/A	20 (34)	25 (43)	25 (43)	50 (85)	15 (26)
HN15S	3/8"	15 (26)	20 (34)	N/A	27 (46)	33 (56)	33 (56)	66 (112)	20 (34)
HN2S	1/2"	19 (32)	25 (43)	N/A	34 (58)	42 (71)	42 (71)	83 (141)	25 (43)
HN1L	1/4"	23 (39)	30 (51)	N/A	41 (68)	50 (85)	50 (85)	50 (85)	30 (51)
HN15L	3/8"	30 (51)	40 (68)	N/A	55 (94)	66 (112)	66 (112)	66 (112)	40 (68)
HN2L	1/2"	38 (65)	50 (85)	N/A	68 (116)	83 (141)	83 (141)	83 (141)	50 (85)
HN3S	3/4"	61 (104)	80 (136)	N/A	109 (185)	133 (226)	133 (226)	133 (226)	80 (136)
HN4S	1"	76 (129)	100 (170)	N/A	136 (231)	166 (282)	166 (282)	232 (394)	100 (170)
HN4L	1"	106 (180)	140 (238)	N/A	191 (325)	232 (394)	232 (394)	232 (394)	140 (238)
HN5S	1 1/4"	190 (323)	250 (425)	415 (706)	330 (461)	415 (706)	415 (706)	415 (706)	250 (425)
HN6S	1 1/2"	260 (442)	350 (595)	600 (1020)	465 (791)	600 (1020)	600 (1020)	600 (1020)	350 (595)
HN8E	2"	260 (442)	350 (595)	600 (1020)	465 (791)	600 (1020)	600 (1020)	600 (1020)	350 (595)
HN8S	2"	340 (578)	450 (765)	750 (1275)	600 (1020)	750 (1275)	750 (1275)	750 (1275)	450 (765)
HN8L	2"	470 (799)	625 (1063)	1035 (1760)	830 (1411)	1035 (1760)	1035 (1760)	1035 (1760)	625 (1063)
HN0L	2 1/2"	600 (1020)	800 (1360)	1330 (2261)	1060 (1802)	1330 (2261)	1330 (2261)	1330 (2261)	800 (1360)
HN12L	3"	750 (1275)	1000 (1700)	1660 (2822)	1330 (2261)	1660 (2822)	1660 (2822)	1660 (2822)	1000 (1700)

Replacement Element Part Numbers

*Insert selected media grade 4, 6, 8, 10.

Housing Assembly	Coalescer	Coalescer w/inner retainer	High Temperature	Coalescer w/built-in pre-filter	ME Mist Eliminator	7CVP Pleated Coalescer	3PU Particulate Removal	100WS Water Separator	AU Adsorber
HN1S	*C10-025	*IU10-025	*DS10-025	*QU10-025	N/A	N/A	3PU10-025	100WSU10-025	AU10-025
HN15S	*C10-025	*IU10-025	*DS10-025	*QU10-025	N/A	N/A	3PU10-025	100WSU10-025	AU10-025
HN2S	*C10-025	*IU10-025	*DS10-025	*QU10-025	N/A	N/A	3PU10-025	100WSU10-025	AU10-025
HN1L	*C10-050	*IU10-050	*DS10-050	*QU10-050	N/A	N/A	3PU10-050	100WSU10-025	AU10-050
HN15L	*C10-050	*IU10-050	*DS10-050	*QU10-050	N/A	N/A	3PU10-050	100WSU10-025	AU10-050
HN2L	*C10-050	*IU10-050	*DS10-050	*QU10-050	N/A	N/A	3PU10-050	100WSU10-025	AU10-050
HN3S	*C15-060	*IU15-060	*DS15-060	*QU15-060	N/A	N/A	3PU15-060	100WSU15-060	AU15-060
HN4S	*C15-060	*IU15-060	*DS15-060	*QU15-060	N/A	N/A	3PU15-060	100WSU15-060	AU15-060
HN4L	*C15-095	*IU15-095	*DS15-095	*QU15-095	N/A	N/A	3PU15-095	100WSU15-060	AU15-095
HN5S	*CU25-130	*CU25-130	*DS25-130	*QU25-130	ME25-130	7CVP25-130	3PU25-130	100WS25-130	AU25-130
HN6S	*CU25-130	*CU25-130	*DS25-130	*QU25-130	ME25-130	7CVP25-130	3PU25-130	100WS25-130	AU25-130
HN8E	*CU25-130	*CU25-130	*DS25-130	*QU25-130	ME25-130	7CVP25-130	3PU25-130	100WS25-130	AU25-130
HN8S	*CU25-187	*CU25-187	*DS25-187	*QU25-187	ME25-187	7CVP25-187	3PU25-187	100WS25-187	AU25-187
HN8L	*CU25-235	*CU25-235	*DS25-235	*QU25-235	ME25-235	7CVP25-235	3PU25-235	100WS25-235	AU25-235
HN0L	*CU35-280	*CU35-280	*DS35-280	*QU35-280	ME35-280	7CVP35-280	3PU35-280	100WS35-280	AU35-280
HN12L	*CU35-280	*CU35-280	*DS35-280	*QU35-280	ME35-280	7CVP35-280	3PU35-280	100WS35-280	AU35-280

Step 2a. Alternate Housing Selection Chart

Use this step for applications with technical gases or for applications that do not have standard conditions (100 PSIG and 70°F).

Gas	Specific Gravity
Air	1.00
Ammonia	0.58
Argon	1.37
Carbon Dioxide	1.52
Carbon Monoxide	0.96
Chlorine	2.48
Ethane	1.04
Ethylene	0.97
Helium	0.13
Hexane	2.73
Hydrogen	0.06
Methane	0.55
Natural Gas	0.66
Neon	0.69
Nitrogen	0.96
Oxygen	1.18
Pentane	2.47
Propane	1.56

Converting Actual Application Conditions to Standardized Conditions

Because the required size of a filter is affected not only by flow, but also by operating pressure and operating temperature, it is necessary to convert those actual conditions to standardized conditions (100 PSIG and 70°F). The calculated adjusted flow rate can then be used to choose the appropriate filter in the chart on the previous page. When using the chart, choose the closest flow rate from the appropriate media grade column.

Note: Take the square root of your specific gravity. If this is for a compressed air application, skip this step because the specific gravity of air equals one. Please see chart to the left for specific gravities.

Refer to this chart if you do not know the specific gravity of the gas you are filtering.

Equation for Adjusted Flow Rate

Flow Rate:	Pressure:	Temperature:	Specific Gravity:	Adjusted Flow Rate:
Actual System Flow Rate (SCFM)	$\times \frac{(\text{System Pressure (PSIG)} + 14.7 \text{ PSIG})}{(100 \text{ PSIG} + 14.7 \text{ PSIG})}$	$\times \frac{70^\circ\text{F} + 460^\circ\text{F (System Temp. } ^\circ\text{F} + 460^\circ\text{F)}}{70^\circ\text{F} + 460^\circ\text{F}}$	$\times \sqrt{\text{(See chart above)}}$	$= \frac{\text{SCFM}}{\text{(@ 100 PSIG, and 70°F)}}$

Example

Your compressed air application requires a Media Grade 6 Coalescer Filter. The actual flow rate is 136 SCFM, an actual pressure of 150 PSIG, and an actual temperature of 100°F.

$$136 \text{ SCFM} \times \frac{(100 \text{ PSIG} + 14.7 \text{ PSIG})}{(150 \text{ PSIG} + 14.7 \text{ PSIG})} \times \frac{(100^\circ\text{F} + 460^\circ\text{F})}{70^\circ\text{F} + 460^\circ\text{F}} \times 1 = 100 \text{ SCFM}$$

Return to the Housing Selection Chart on the previous page. Using the given information and the result from the above equation, you will look for the “Grade 6C” column heading. In this column you will find that the correct housing assembly for a 100 SCFM flow rate would be the **HN4S** model.

Step 3. Accessories

Choose your accessories. Please consult Parker Finite when choosing pre-installed accessories for gases other than air.

Pre-installed Accessories

Accessory Designator	Accessory Type	Maximum Pressure	Maximum Temperature
A	Auto Drain	250 PSIG (17 bar)	175°F (79°C)
D	DPI Indicator	250 PSIG (17 bar)	175°F (79°C)
G	DPG Gauge	500 PSIG (34 bar)	175°F (79°C)
J	High Temp	250 PSIG (17 bar)	450°F (232°C)
N	No Accessories	500 PSIG (34 bar)	175°F (79°C)
P	DP Ports (1/8" NPT gauge ports)	500 PSIG (34 bar)	175°F (79°C)
V	Fluorocarbon O-rings	500 PSIG (34 bar)	175°F (79°C)
W	Auto Drain and DPI Indicator	250 PSIG (17 bar)	175°F (79°C)
X	Auto Drain and DP Ports	250 PSIG (17 bar)	175°F (79°C)
Y	Auto Drain and DPG Gauge	250 PSIG (17 bar)	175°F (79°C)



	DPG-15 Differential Pressure Gauge		DPI Indicator	AD-12 Auto Drain Valve
Designator	Y	G	D, W	A, W, X, Y
Temperature	175° F (79° C)	175° F (79° C)	175° F (79° C)	175° F (79° C)
Pressure	250 PSIG (17 Bar)	500 PSIG (17 Bar)	250 PSIG (17 Bar)	250 PSIG (34 Bar)
Port Size	N/A	N/A	N/A	N/A

Note: Auto drains require a minimum operating pressure of 10 PSIG to seal.

Other Compatible Accessories



	TV-50 Timed Drain Valve	ZLD-013 Zero Loss Drain	VS-50 Visual Sump Drain (not shown: standard bowl guard)	MS-50 Metal Sump Drain (External)
Temperature	210° F (99° C)	140° F (60° C)	125° F (52° C)	175° F (79° C)
Pressure	300 PSIG (20 Bar)	232 PSIG (16 Bar)	150 PSIG (10 Bar)	250 PSIG (17 Bar)
Port Size	1/2" NPT	1/2" NPT	1/2" NPT	1/2" NPT

Note: The accessories above are compatible with this product line, however, they are sold separately. Other timed drain valves can be found in the Air Line Filtration Accessories section.

Mounting brackets available: BK-M (1/4" - 1/2" connections); BK-3 (3/4" - 1" connections).

Step 4. How to Order

Use the steps below to build your own part number.
For any permutation not mentioned below, please consult factory.

Step 2 or 2a		Step 1				Step 3	
H	N	12	L	6	C	U	G
Series Name	Port Type	Port (Connection) Size	Bowl	Element Grade	Element Type	End Seal	Accessory Designator for pre-installed accessories
H	F - BSPP N - NPT	1 - 1/4" 15 - 3/8" 2 - 1/2" 3 - 3/4" 4 - 1" 5 - 1 1/4" 6 - 1 1/2" 8 - 2" 0 - 2 1/2" 12 - 3"	S - Standard L - Long E - Economy (short bowl)*	4 6 8 10	C	Blank = No end seal, Standard on 1/4" to 1" connection sizes U = Urethane, Standard on 1 1/4" to 3" connection sizes S = Molded Silicone Rubber V = Fluorocarbon gasket with metal end caps, Available 1/4" to 3" connections only	A - Auto Drain D - DPI Indicator G - DPG Gauge J - High Temperature (up to 450°F) N - No Accessories P - 1/8" Differential (3/4" & up) Sensing Ports V - Fluorocarbon O-rings W - A + D X - A + P (3/4" & up) Y - A + G
	S - SAE* *SAE-32 2" connection only	8 - SAE-32	*Economy bowl is only available on 2" connection size. Note: Bowl length is determined by the flow rate required. Housing Selection Chart, for flow rates.	Note: Grades are available on element type C, Q, and D. For 7CVP, 7DVP, ME, 3P, 100WS and A, leave this blank.			Note: For maximum pressures and temperatures related to Accessories, please see chart on previous page.
					Q	U = Urethane, Standard all connection sizes S = Molded Silicone Rubber	
					D	S = Molded Silicone Rubber, Standard on all connection sizes V = Fluorocarbon gasket with metal end caps, Available in 1/4" to 3" connection sizes only	
					7CVP 7DVP ME	Blank = Fluorocarbon gasket with metal end caps, Standard on all 7CVP, 7DVP, and ME elements; elements available in 1/4" to 3" connections only	
					3P	U = Urethane, Standard all connection sizes S = Molded Silicone Rubber V = Fluorocarbon gasket with metal end caps, Available 1/4" to 3" connections only	
					100WS	U = Urethane, Standard on 1/4" to 1" connection sizes Blank = Fluorocarbon gasket with metal end caps, Standard on 100WS elements 1/4" to 3" connections only	
					A	U = Urethane, Standard on all connection sizes V = Molded Silicone Rubber	

Examples on How to Order:

Example 1:	Example 2:	Example 3:	Example 4:	Example 5:
HN12L-6CUY	HN15L-8CA	HN8S-7CVPG	HN8E-10DVJ	HN2S-AUN
What am I ordering? An H-Series, with a 3" NPT connection, long bowl, standard grade 6 coalescing element with urethane end seals, an auto drain and a standard DPG gauge.	What am I ordering? An H-Series, with a 3/8" NPT connection, long bowl, grade 8 coalescing element without end seals and an auto drain.	What am I ordering? An H-Series, with a 2" NPT connection, standard bowl, a 7CVP coalescing element, with the standard fluorocarbon end seals and standard DPG gauge.	What am I ordering? An H-Series, with a 2" NPT connection, economy short bowl, grade 10 high-temp coalescing element, with the standard fluorocarbon end seals and "J" as an accessory. This high temperature option converts all materials to be capable of handling temperatures of 450°F.	What am I ordering? An H-Series, with a 1/2" NPT connection, short bowl, adsorber element, with the standard urethane end seals and no accessories.

H-Series Drawings, Dimensions & Specifications

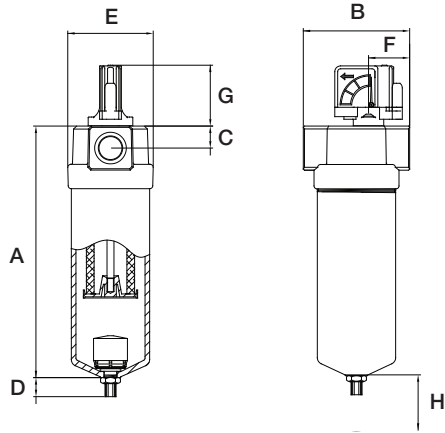

1/4" to 1" Port Size Housing Specifications

Max. Pressure:	500 psig (34 bar)
Safety Factor:	Maximum operating to burst 4:1
Max. Temp.:	175°F (79°C) with option to 450°F (232°C)
Seals:	Nitrile Standard/ Fluorocarbon optional
Materials:	Aluminum - 380 Die cast heads; 6061 Drawn bowls
Coatings:	Chromated heads and bowls; Powder painted exterior
Design:	In-line threaded bowl to head

Note: Manual Drain Port is 1/8" NPT when tee valve is removed from drain bushing.

Model	A	B	C	D	E	F	G	H*	Sump (ml)	Weight
H_1S	6.80 (172)	3.12 (79)	.63 (16)	.79 (20)	2.98 (76)	1.56 (39.5)	2.6 (66)	2.99 (76)	150	1.49 (.68)
H_15S	6.80 (172)	3.12 (79)	.63 (16)	.79 (20)	2.98 (76)	1.56 (39.5)	2.6 (66)	2.99 (76)	150	1.47 (.66)
H_2S	6.80 (172)	3.12 (79)	.63 (16)	.79 (20)	2.98 (76)	1.56 (39.5)	2.6 (66)	2.99 (76)	150	1.44 (.65)
H_1L	9.19 (233)	3.12 (79)	.63 (16)	.79 (20)	2.98 (76)	1.56 (39.5)	2.6 (66)	5.51 (140)	140	1.89 (.86)
H_15L	9.19 (233)	3.12 (79)	.63 (16)	.79 (20)	2.98 (76)	1.56 (39.5)	2.6 (66)	5.51 (140)	140	1.87 (.85)
H_2L	9.19 (233)	3.12 (79)	.63 (16)	.79 (20)	2.98 (76)	1.56 (39.5)	2.6 (66)	5.51 (140)	140	1.85 (.84)
H_3S	10.86 (276)	4.65 (118)	.96 (24)	.79 (20)	3.68 (93.5)	1.73 (44)	2.6 (66)	6.5 (165)	270	3.56 (1.61)
H_4S	10.86 (276)	4.65 (118)	.96 (24)	.79 (20)	3.68 (93.5)	1.73 (44)	2.6 (66)	6.5 (165)	270	3.29 (1.49)
H_4L	14.36 (365)	4.65 (118)	.96 (24)	.79 (20)	3.68 (93.5)	1.73 (44)	2.6 (66)	10.00 (254)	270	4.11 (1.86)

Special Note: Dimensions are in inches (millimeters); weight is in pounds (kilograms). *Clearance required to remove bowl.

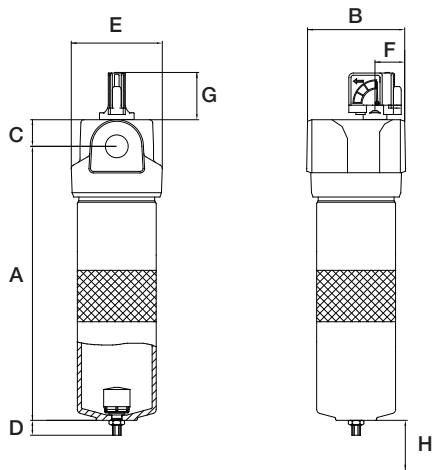

1 1/4" to 3" Port Size Housing Specifications

Max. Pressure:	500 psig (34 bar)
Safety Factor:	Maximum operating to burst 4:1
Max. Temp.:	175°F (79°C) with option to 450°F (232°C)
Seals:	Nitrile Standard/ Fluorocarbon optional
Materials:	Aluminum - 356 Sand cast heads; 6061 Drawn bowls
Coatings:	Chromated heads and bowls; Powder painted exterior
Design:	In-line threaded bowl to head

Note: Manual Drain Port is 1/8" NPT when tee valve is removed from drain bushing.

Model	A	B	C	D	E	F	G	H*	Sump (ml)	Weight
H_5S	18.23 (463)	6.0 (152)	1.65 (42)	.83 (21)	5.67 (144)	1.85 (47)	2.6 (66)	13.50 (343)	440	12.11 (5.49)
H_6S	18.23 (463)	6.0 (152)	1.65 (42)	.83 (21)	5.67 (144)	1.85 (47)	2.6 (66)	13.50 (343)	440	11.97 (5.43)
H_8E	18.23 (463)	6.0 (152)	1.65 (42)	.83 (21)	5.67 (144)	1.85 (47)	2.6 (66)	13.50 (343)	440	11.97 (5.43)
H_8S	24.23 (617)	6.0 (152)	1.65 (42)	.83 (21)	5.67 (144)	1.85 (47)	2.6 (66)	19.25 (489)	530	14.00 (6.35)
H_8L	29.23 (742)	6.0 (152)	1.65 (42)	.83 (21)	5.67 (144)	1.85 (47)	2.6 (66)	24.02 (610)	620	15.99 (7.25)
H_0L	35.70 (907)	8.0 (203)	2.4 (61)	.83 (21)	7.24 (184)	2.36 (60)	2.6 (66)	28.50 (724)	880	35.00 (15.87)
H_12L	35.70 (907)	8.0 (203)	2.4 (61)	.83 (21)	7.24 (184)	2.36 (60)	2.6 (66)	28.50 (724)	880	34.14 (15.48)

Special Note: Dimensions are in inches (millimeters); weight is in pounds (kilograms). *Clearance required to remove bowl.



ASME Code Filter Vessels

Compressed Air & Gas Filtration



ENGINEERING YOUR SUCCESS.

Large Capacity ASME Vessels

Parker Finite's filter vessels eliminate oil, water, and particulate contamination from large flows of compressed air and gas.



Parker Finite's large capacity ASME filter vessels have been designed specifically for our coalescing elements and incorporate large sump capacities and generous exit cavities for maximum performance with low differential pressures.

All units are "U" stamped and conform to ASME Section VIII standard code for pressure vessels. With flow capacities to 37,000 SCFM and optional materials of construction, most compressor source filtration requirements can be met.



Standard Specifications

- **Porting to:** 16" Flange
- **Flows to:** 9,960 SCFM (16,920 m3/hr)
- **Design:** ASME Code/CRN (Canadian Registration)
- **Max. Temp:** 450°F
- **Max. Pressure:** 185 PSIG (unless custom designed)
- **Filter Media:** Coalescing, Particulate, Vapor Adsorption, and Bulk Liquid Removal
- **Configuration:** Floor-Standing or Line-Mounted
- **Drain and Vent Ports:** ½" NPT
- Design allows for easy element changeout

Typical Applications

Coalescing (Oil Removal)	Interceptor (Particulate Removal)	Adsorber (Vapor Removal)
Compressed air system protection	Natural gas inlet systems	Odor removal
Dryer protection - Mist eliminator	Desiccant dryer after-filter	Food packaging
Paint spray booths	Pre-filter for coalescer	Powder paint systems
Microelectronics quality air pre-filtration	Systems with high particulate concentration	Blow molding
Landfill gas	Particulate protection for non-lubricated systems	Breathing air
Natural gas treatment		

Custom ASME Vessels

Call our technical department at 1-800-343-4048 to ask about our custom ASME vessels.

Custom options include:

- Stainless steel vessels (304 & 316 SS options)
- High pressure
- Corrosion allowance
- Non-standard port orientation
- Sight glass ports
- Custom name plates
- Liquid level control connections

Compressed Air Standards and Applications

ISO 8573-1 is an international standard that has become the universally accepted method for specifying and testing the purity of compressed air. ISO 8573-1 specifies a purity “class” based on contaminants in compressed air. There are three classes that describe 1) particulate contamination concentration, 2) liquid or vaporous water contamination concentration, and 3) the contamination concentration caused by oil in the liquid, aerosol, and vapor states. The ISO purity class is always stated using three numbers in a definite order: the solid particulate class, followed by the water contamination class, and finally the oil contamination class. Use the table below to see how the purity classes for each contaminant type are defined.

International ISO Standards							
ISO8573-1: 2010 CLASS	Solid Particulate			Mass Concentration mg/m ³	Water		Oil
	Maximum number of particles per m ³				Vapor Pressure Dewpoint	Liquid g/m ³	Total Oil (aerosol liquid and vapor) mg/m ³
	0.1 - 0.5 micron	0.5 - 1 micron	1 - 5 micron				
0	As specified by the equipment user or supplier and more stringent than Class 1						
1	≤ 20,000	≤ 400	≤ 10	-	≤ -94°F (-70°C)	-	0.01
2	≤ 400,000	≤ 6,000	≤ 100	-	≤ -40°F (-40°C)	-	0.1
3	-	≤ 90,000	≤ 1,000	-	≤ -4°F (-20°C)	-	1
4	-	-	≤ 10,000	-	≤ 37.4°F (3°C)	-	5
5	-	-	≤ 100,000	-	≤ 44.6°F (7°C)	-	-
6	-	-	-	≤ 5	≤ 50°F (10°C)	-	-
7	-	-	-	5 - 10	-	≤ 0.5	-
8	-	-	-	-	-	0.5 – 5	-
9	-	-	-	-	-	5 – 10	-
X	-	-	-	> 10	-	> 10	> 5

*At 14.7 psi (1 bar) absolute pressure, +70°F (+20°C) and a relative humidity of 60%. It should be noted that at pressures above atmospheric, the contaminant concentration is higher.

Note: The quality of the air delivered by non-lubricated compressors is influenced by the quality of the intake air and the compressor design.

Typical Applications

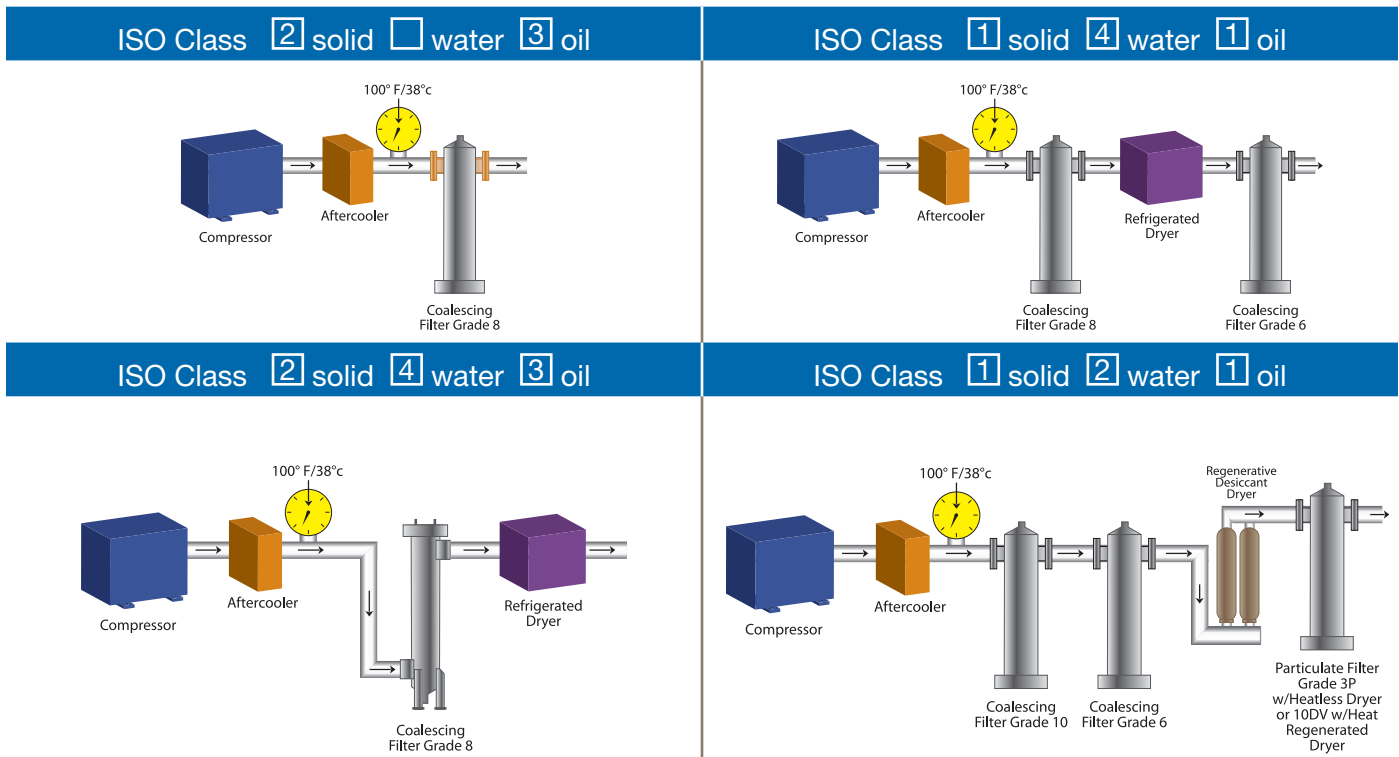

Note: Contribution of hydrocarbon vapors has not been taken into account in determining the oil class category in the above illustrations.

Determine your application, media grade, media type, and end seals.

Find your (or similar) application from the descriptions below, from the basic application circuits on the previous page, or consult a Parker application engineer. Determine media grade, media type, and end seal required. If your application requires a coalescing element, use the information listed below. For other media types, please see the following page.

Coalescing Elements (removal of liquids and particulate)



Media Type C or Q

Available in grades 6, 8, 10

Air flow: Inside to outside

This coalescing element is composed of an epoxy saturated, borosilicate glass micro-fiber tube. Type Q has a pleated cellulose inner layer as a built-in pre-filter. This element is metal retained for added strength, and includes a synthetic fabric layer to aid in draining liquids away from the coalescing layer.

Media type Q is shown here. Media type C has the same coalescing outer layer, without the inner pleated layer.

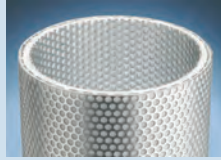

Media Type D

Available in grades 6, 8, 10

Air flow: Inside to outside

The type D element is composed of a binderless micro-glass coalescer layer surrounded by two metal retainers. These metal retainers, coupled with a glass drain layer and an outer perforated metal handling layer, make this a robust element designed to handle high temperatures.

This element is typically used as a high temperature coalescer, or the particulate after-filter for a heated regenerative desiccant dryer.



Media Type ME

Air flow: Inside to outside

Finite's Mist Eliminator (ME) media consists of two filtration layers pleated together. The outer layer consists of a dense matrix of glass fibers. This coalescing layer provides highly efficient aerosol removal and very low pressure drop. The inner layer effectively traps dirt particles, protecting and extending the life of the outer layer. This element is metal retained for added strength, and includes a synthetic fabric layer to aid in draining liquids away from the coalescing layer.

The Finite ME element maintains its high efficiency rating even at low flow rates, allowing the user to specify Finite housings that are oversized for the application, greatly extending the life of the element. Due to the stainless steel components used in the ME element, it is ideally suited for long life service or corrosive environments.

Type ME elements are great pre-filters for all types of air dryers. This element maintains dryer efficiency by removing oil before it damages costly desiccant or membranes. It also protects refrigerated dryers by preventing coating of coils with oil or varnish.

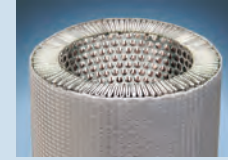

Media Type 7CVP / 7DVP

Air flow: Inside to outside

Finite's 7CVP media consists of two layers. The outer layer consists of a dense matrix of glass fibers. This coalescing layer provides highly efficient aerosol removal and very low pressure drop. The inner layer effectively traps dirt particles, protecting and extending the life of the outer layer. This element is metal retained for added strength, and includes a synthetic fabric layer to aid in draining liquids away from the coalescing layer.

This media is used in bulk coalescing applications and when relatively high efficiency and low pressure drop are required.

Type 7CVP elements are great pre-filters for refrigerated air dryers, where low differential pressure is a requirement. This element maintains dryer efficiency by preventing the coating of heat exchanger coils with oil and varnish.

For a high temperature version of this element, specify media type 7DVP.

Choose a filter grade for media types C, Q, or D

Grade 6 (Standard)

Grade 6 filters are used when "total removal of liquid aerosols and suspended fines" is required. Because of its overall performance characteristics, this grade is most often recommended.

A grade 6 element is great pre-filter protection for desiccant air dryers. This element prevents oil or varnish from coating the desiccant, while maintaining the dryer efficiency.

Grade 8

Grade 8 filters combine high efficiency with high flow rate and long element life. A separate pre-filter is not required for "normal to light" particulate loading.

A grade 8 element is great pre-filter protection for refrigerated air dryers. This element maintains dryer efficiency by preventing coating of coils with oil or varnish.

Grade 10

Grade 10 filters are used as pre-filters for grades 6 or 8 to remove gross amounts of liquid aerosols or tenacious aerosols which are difficult to drain. This grade is often referred to as a coarse coalescer.

A grade 10 element coupled with media type D is a recommended after-filter for heat regenerated type dryers.

Water Separator Element
(removal of bulk liquids)

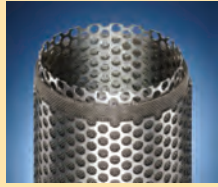

Media Type 100WS

Air Flow: Inside to outside

This all stainless steel mesh element has two metal retainers with rolled mesh steel in between. It is an extremely robust design.

This media is used for the reduction and elimination of excess liquids in gas streams. Excellent prefiltration for coalescing grades 6 and 10 when extreme quantities of liquid contaminants are present.

Particulate Removal Element
(removal of particulate)

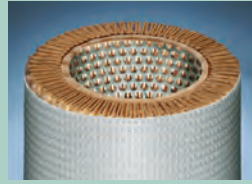

Media Type 3P

Air Flow: Outside to inside

This particulate element is constructed of pleated cellulose with a 3 micron rating. It is metal retained for added strength and includes an outer handling layer.

3P particulate interceptor elements are used where high dirt holding capacity and relatively fine pore structure are required.

Adsorption Element
(removal of odors)



Media Type A

Air Flow: Outside to inside

This hydrocarbon vapor removal element consists of an ultrafine grained, highly concentrated, activated carbon sheet media. It is metal retained for added strength and includes an outer synthetic fabric layer. Maximum hydrocarbon inlet concentration .5 to 2 PPM.

Parker Finite Media Specifications

Media Grade	Coalescing Efficiency 0.3 to 0.6 Micron Particles	Maximum Oil Carryover ¹ PPM w/w	Micron Rating	Pressure Drop (PSID) @ Rated Flow ²	
				Media Dry	Media Wet with 10-20 wt. oil
6	99.97%	0.008	0.01	1.5	4.0
ME	99.95%	0.02	0.3	0.5	1.0
7	99.5%	0.09	0.5	0.25	0.5
8	98.5%	0.2	0.5	1.0	3.5
10	95%	0.85	1.0	0.75	2.5
100WS	N/A	N/A	100	< 0.25	< 0.50
3P	N/A	N/A	3.0	0.25	N/A
A	99+% ³	N/A	N/A	1.0	N/A

¹Tested per ISO 12500-1.

²Add dry + wet for total pressure drop.



³Oil vapor removal efficiency is given for A media.

End Seals Available:

End Seals	Available on Media Type	Max temp of Element with End seal
U: Molded Urethane, Standard	C	225°F (107°C)
	Q	225°F (107°C)
	3P	225°F (107°C)
S: Molded silicone rubber end seals used for high temperature elements up to 450°F (232°C)	C	350°F (177°C)
	Q	350°F (177°C)
	D	450°F (232°C)
V: Fluorocarbon gaskets bonded to metal end caps	3P	350°F (177°C)
	C	350°F (177°C)
	Q	350°F (177°C)
	D	450°F (232°C)
	ME	225°F (107°C)
	7CVP	225°F (107°C)
	7DVP	400°F (204°C)
	100WS	450°F (232°C)
	3P	350°F (177°C)
	A	225°F (107°C)

Housing Selection Chart

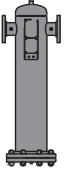
Line-Mount Vessels

Housing Assembly Number	Replacement Element Number	Port Size (in.)	Port Type	Number of Elements	Rated Flows: SCFM@ 100 PSIG (m ³ hr@ 7 bar)		
					Grade 6/A	Grade 8	Grade ME / 7CVP / 10 100WS / 3P
 HT3-801	51-280	3	NPT	1	1500 (2540)	1800 (3050)	2490 (4230)
FT3-801	51-280	3	FLANGE	1	1500 (2540)	1800 (3050)	2490 (4230)
FT4-1201	85-250	4	FLANGE	1	2000 (3390)	2400 (4070)	3320 (5640)
FT6-1201	85-360	6	FLANGE	1	3000 (5090)	3600 (6110)	4980 (8460)
 FT6-1603	51-280	6	FLANGE	3	4500 (7640)	5400 (9170)	7470 (12690)

Floor-Standing Vessels

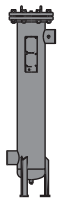
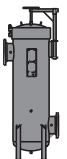
 HF3-801	51-280	3	NPT	1	1500 (2540)	1800 (3050)	2490 (4230)
FF3-801	51-280	3	FLANGE	1	1500 (2540)	1800 (3050)	2490 (4230)
FF4-1201	85-250	4	FLANGE	1	2000 (3390)	2400 (4070)	3320 (5640)
FF6-1201	85-360	6	FLANGE	1	3000 (5090)	3600 (6110)	4980 (8460)
 FF6-1603	51-280	6	FLANGE	3	4500 (7640)	5400 (9170)	7470 (12690)
FF8-1804	51-280	8	FLANGE	4	6000 (10190)	7200 (12230)	9960 (16920)

Note: Consult factory for larger sizes

How to Order

Complete Assembly*

Housing Assembly Number	Media Grade	Media Type	End Seals
Complete Part Number Examples: FF3-801-6QU FF6-1603-7CVP	6 8 10	C Q D ME 7CVP 7DVP 100WS 3P A	U Urethane can be used for media types: C, Q, and 3P. S Silicone rubber can be used for media types C, Q, D, and 3P. V Fluorocarbon can be used on C, Q, D, 3P. Standard on ME, 7CVP, 7DVP, 100WS, and A.
*Complete assembly includes vessel and elements. Elements are shipped separately from vessel.	Note: Only add media grade for C, Q, and D		

See pages 40-41 for more information on media grades, types, and end seals.

Replacement elements

1. Choose the media grade, type, and end seals that you need.
2. See the Housing Selection Chart above to find the appropriate Replacement Element Number.
3. Put 1 & 2 together.

For example:

6 **Q** **U** **51-280** or **7CVP** **85-250**

ASME Drawings, Dimensions & Specifications

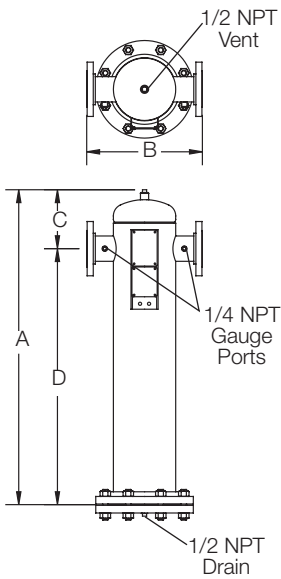

Refer to this drawing for:
HT3-801(NPT)
FT3-801
FT4-1201
FT6-1201

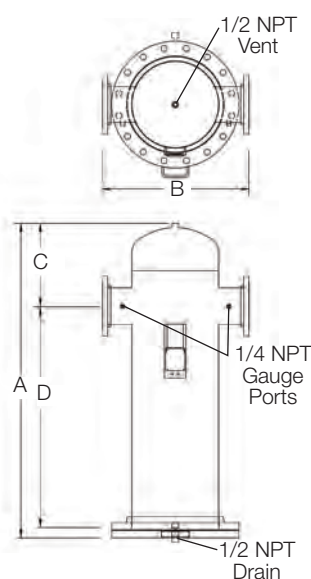

Refer to this drawing for:
FT6-1603

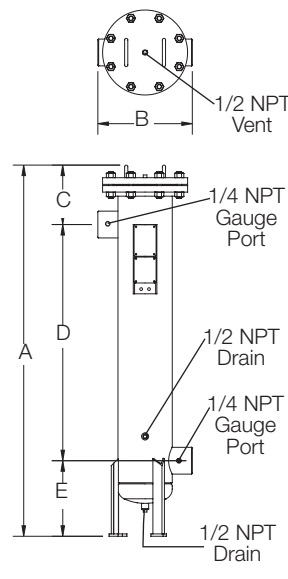

Refer to this drawing for:
HF3-801(NPT)
FF3-801
FF4-1201
FF6-1201

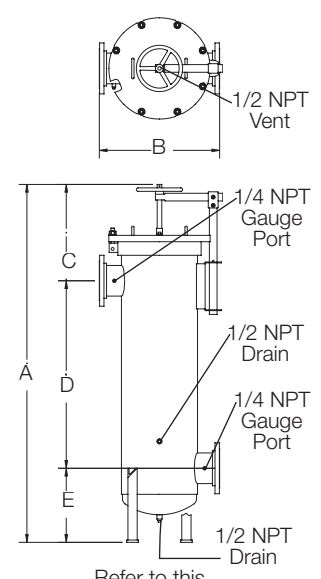

Refer to this drawing for:
FF6-1603
FF8-1804

Dimension ¹	A	B	C	D	E	Element Removal Clearance	Sump Capacity ²	Weight ³
HT3-801	43.1 (109.5)	15.0 (38.1)	7.7 (19.5)	35.4 (89.9)		28 (71.1)	0.81 (3)	190 (86)
FT3-801	43.1 (109.5)	16.0 (40.6)	7.7 (19.5)	35.4 (89.9)		28 (71.1)	0.81 (3)	190 (86)
FT4-1201	42.7 (108.5)	20.0 (50.8)	9.7 (24.6)	33.0 (83.8)		25 (63.5)	2.0 (7)	380 (173)
FT6-1201	56.4 (143.3)	20.0 (50.8)	11.4 (29.0)	45.0 (114.3)		36 (91.4)	2.0 (7)	380 (173)
FT6-1603	58.25 (147.9)	27.1 (66.0)	15.4 (39.0)	41.5 (105.4)		28 (71.1)	2.0 (7)	340 (155)
HF3-801	58.9 (149.6)	15.0 (38.1)	9.4 (23.8)	37.5 (95.2)	12.0 (30.4)	28 (71.1)	1.1 (4)	190 (86)
FF3-801	58.9 (149.6)	16.0 (40.6)	9.4 (23.8)	37.5 (95.2)	12.0 (30.4)	28 (71.1)	1.2 (4)	200 (91)
FF4-1201	63.3 (160.7)	20.0 (50.8)	12.3 (31.2)	35.0 (88.9)	16.0 (40.6)	25 (63.5)	4.2 (16)	370 (168)
FF6-1201	75.3 (191.2)	20.0 (50.8)	12.3 (31.2)	47.0 (119.3)	16.0 (40.6)	36 (91.4)	3.6 (14)	410 (186)
FF6-1603	77.3 (196.3)	26.0 (66.0)	20.8 (52.8)	40.5 (102.8)	16.0 (40.6)	28 (71.1)	5.0(19)	340 (155)
FF8-1804	87.3 (221.7)	30.0 (76.2)	25.8 (65.5)	42.5 (108.0)	19.0 (48.3)	28 (71.1)	8.7 (33)	550 (250)

¹Dimensions are in inches (centimeters). ²Sump Capacity is in gallons (liters). ³Weight is in pounds (kilograms).

Materials of Construction

Body:	Carbon Steel
Paint:	Epoxy Enamel (Gray)
Internals:	Epoxy powder painted carbon steel
Seals:	Inorganic flange gasket (single element vessels)
	Fluorocarbon o-ring (multi element vessels)
Internal Coating:	Epoxy enamel

Specifications

Max Pressure:	185 psig (12.5 bar)
Max Temperature:	450°F (232°C)

Meets A.S.M.E. Code, Section VIII, Division 1

Note: Consult factory for special requirements.

Accessories

Gauges

Differential pressure gauges indicate pressure loss through the filter. As the filter element becomes loaded with contamination, differential pressure rises. Changing out the clogged filter element is usually more economical than continued operation at elevated pressures (6-8 PSID).

KBDPG-15 Differential Pressure Gauge Kit

- Kit includes gauge, 1/8" and 1/4" NPT brass fittings, flexible nylon tubing, and mounting bracket.



Temp: 200°F (93°C)
Pressure: 250 PSIG (17 bar)

KBDPI-25 Differential Pressure Gauge Kit

- Kit includes gauge, 1/8" and 1/4" NPT brass fittings, flexible nylon tubing, and mounting bracket.



Temp: 200°F (93°C)
Pressure: 250 PSIG (17 bar)

Drains

Parker offers several choices of automatic drains, ranging from simple float actuated drains, programmable solenoid types, and smart zero-air loss drains, which conserve energy by only draining when liquid is present.

ADT-50 Float Actuated Drain Trap

- 1/2" NPT Inlet Connection
- 1/4" NPT Outlet Connection



Temp: 450°F (232°C)
Pressure: Max=289 PSIG (20 bar);
Min. = 15 PSIG (1 bar)

ZLD-023 Zero Air Loss Condensate Drain

- 1/2" NPT Connection
- Electrical connection = 115 vAC
- Other Models Available



Temp: 35° - 140°F (2 - 60°C)
Pressure: 3 - 232 PSIG (0.2 - 16 bar)

TV-50 Timed Solenoid Valve Drain Trap

- 1/2" NPT Connection
- Electrical connection = 110 vAC
- Other Models Available



Temp: 210°F (99°C)
Pressure: 300 PSIG (20 bar)

ADS-50 Float Actuated Stainless Steel Drain Trap

- 304 stainless steel construction
- 1/2" NPT Inlet and Outlet Connections



Temp: 450°F (232°C)
Pressure: 400 PSIG (28 bar)

Note: Accessories are sold separately from the ASME vessels.



BA-Series Dual Stage Compressed Air Filters

Point-of-Use Breathing Air Filters

Breathing Air Purifiers

Dual-Stage Compressed Air Filters - BA-Series

BA-Series filters are designed to be used as point-of-use breathing air filters. This combination unit contains both a fine grade coalescing filter element and an activated carbon vapor removal element. BA-Series filters may also be used in applications requiring compressed air to be free of odor or taste bearing hydrocarbons. Food and beverage applications would be typical where compressed air comes in contact with the product. The BA-Series can also be used as a pre-filter for critical needs such as zero air generators, membrane filters and many others!

Replacement elements are supplied in convenient repair kits which include one coalescing element, two activated carbon adsorber elements, and replacement seals. Two adsorber elements are supplied because the stage one coalescer will routinely outlive the extremely sensitive second stage adsorber element.

For severe applications with excessive solid and liquid contaminants, the BA-Series should be preceded by Parker Finite H-Series pre-coalescer or interceptor filters.

Parker Finite also supplies pressure regulators which can be used downstream of the BA-Series to lower system operating pressures to desired levels for breathing air applications. Please refer to the "Air Preparation Units" section of this catalog.



Parker Finite BA-Series Purifiers are available in 1/4" - 1" NPT connection sizes.

Product Features:

- Connection sizes: 1/4" - 1" NPT
- Flows: Up to 75 SCFM
- Maximum pressure: 500 PSIG
- Maximum temperature: 175° F
- Drain port: 1/8" NPT with standard manual drain (float drain available)

Typical Applications:

- Industrial breathing air
- Aircraft cabin air
- Zero air generator pre-filter
- Instrument air
- Food processing / Packaging
- Membrane pre-filtration
- Instrument air dryer pre-filter

How it Works

Compressed air enters Port 1 of the housing and is directed down a hollow chamber into the first-stage coalescing element (bottom). Oil, water and solid contaminant is removed with a 99.97% or higher efficiency as the air flows from the inside of the element to the outside. The coalesced liquid drains off the element into the bowl where it is removed either manually, or by an automatic float drain. The oil-free air then is redirected upwards to the inside of the adsorber element (top) by means of a non-bypassing separation device. The second stage's activated carbon element collects hydrocarbon vapors as the air flows from the inside to the outside of the element. The purified air then exits through Port 2 of the housing.

Note: This product does not remove toxic gases from the air stream. A carbon monoxide monitor is recommended.

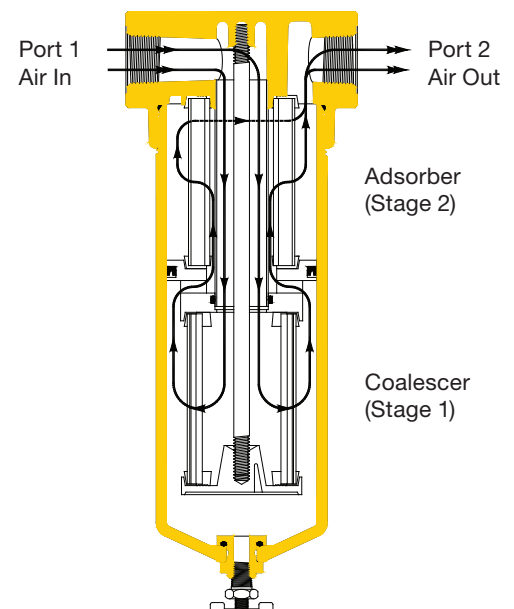

Choose Your Media Type

All BA filters have an activated carbon element (Stage 2). Depending on the application, you may either choose to use a micro-glass coalescer media type (C) or a micro-glass coalescer with a built-in pre-filter (Q) (Stage 1.)

Stage 1 – Coalescing

Coalescing Elements (removal of liquids and particulate)

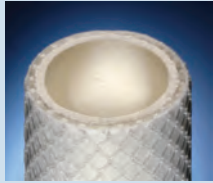

Media Type C

Available in grades 4, 6

This coalescing element is made with our special UNI-CAST construction. Composed of an epoxy saturated borosilicate glass micro-fiber media, this media is used in applications requiring the removal of liquid and particulate contamination. The outer synthetic fabric layer allows for swift removal of coalesced liquids.

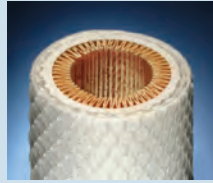

Media Type Q

Available in grades 4, 6

This coalescing element is composed of an epoxy saturated, borosilicate glass micro-fiber media, and is also made with our special UNI-CAST construction. This media type has a built-in pleated cellulose pre-filter as the inner layer. As with the C media type, the outer synthetic fabric layer aids in the swift and efficient removal of coalesced liquids.

Stage 2 – Adsorption

Adsorption Element (removal of odors)



Media Type A

This hydrocarbon vapor removal element consists of an ultra-fine grained, highly concentrated, activated carbon sheet media. This media type is used to remove hydrocarbon vapor and is often used to remove the smell or taste of compressor lube oil from breathing air.

Grade 4

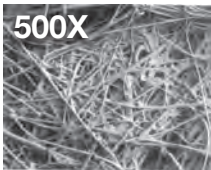

Grade 6

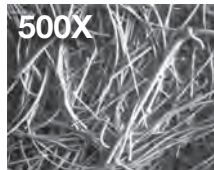

Stage 1 coalescers come in grade 6 (standard) or grade 4. Choose grade based on coalescing efficiencies in the chart on the following page.

Grade A

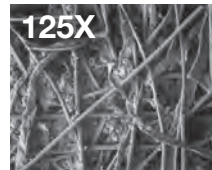

Stage 2 adsorbers polish the air stream of final trace amounts of hydrocarbon vapors with an efficiency of 99%+.

Specifications and Flow Rates

Coalescing Media Specifications

Media Grade	Coalescing Efficiency .3 to .6 Micron Aerosols	Maximum Oil Carryover ¹ PPM w/w	Micron Rating
4	99.995%	.003	.01
6	99.97%	.008	.01

¹Tested per ISO 12500-1.

Flow Ratings

Part Number	BAN1L		BAN15L		BAN2L		BAN3S		BAN4S		BAN3L		BAN4L	
Grade	4	6	4	6	4	6	4	6	4	6	4	6	4	6
Max. Rated Flow (SCFM) at 100 PSIG	10	14	12	16	14	18	25	30	35	45	40	60	50	75
Δp (dry)	2.0		2.0		2.0		1.5		2.0		1.5		2.0	
Δp (wet)	4.0		4.0		4.0		3.5		4.0		3.5		4.0	

Note: The differential pressure (Δp) includes the effects of the housing and both elements.

Expected Lifespan of BA-Series Filter Elements

Expected life of the filter elements is entirely dependent on the quality of the incoming compressed air, but can be several thousand hours. However, the elements should be changed whenever odors and/ or taste become present regardless of hours in operation.

Application

Use any compressor with after-cooler and refrigerated dryer. Air intended for use as industrial breathing air and in decompression chambers.

CAUTION: Always use high temperature synthetic lubricants and monitor (alarm) for carbon monoxide concentrations exceeding established maximum recommended levels. This system will not eliminate toxic gases!

Other Specs Met:

OSHA 29CFR 1910.134

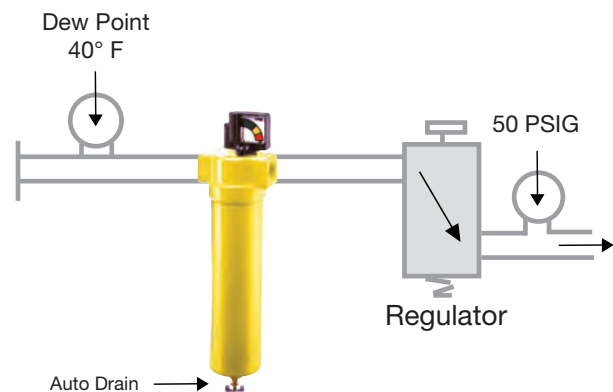

How to Order

Complete Dual-Stage Assembly Part Code Example:

BA	N	3	L 	6	C	U	Y
Series Name	Port Type	Port (Connection) Size	Bowl	Element Grade	Element Type	End Seal	Accessory Designator for pre-installed accessories
BA	N - NPT	1 - 1/4" 15 - 3/8" 2 - 1/2" 3 - 3/4" 4 - 1"	S - Standard L - Long (S available on 3/4" and 1" port size only) Note: Bowl length is determined by the flow rate required. See Flow Ratings Chart on the previous page.	4 6	C Q Note: Designate first stage; grade and media type, second stage; media type will always be "A" media, and is not designated in the part number.	U - Urethane (Standard all connection sizes)	A - Auto Drain D - DPI Indicator (1/4" - 1/2" only) G - DPG Gauge N - No Accessories W - A + D (1/4" - 1/2" only) Y - A + G

BA-Series Replacement Element Part Code Example:

K	BA	3	L	6	C	U
Repair Kit	Series Name	Port (Connection) Size	Bowl	Element Grade	Element Type	End Seal
K	BA	1 - 1/4" 15 - 3/8" 2 - 1/2" 3 - 3/4" 4 - 1"	S - Standard L - Long (S available on 3/4" and 1" port size only)	4 6	C Q	U - Urethane (Standard all connection sizes)

Example: KBA3L6CU

Note: Each repair kit contains (1) coalescing element, (2) activated carbon adsorber elements and replacement seals.

Note: Mounting brackets available: BK-M 1/4 - 1/2" connections
BK-3 3/4 - 1" connections

Pre-installed Accessories

Accessory Designator	Accessory Type	Maximum Pressure	Maximum Temperature
A	Auto Drain	250 PSIG (17 bar)	175°F (79°C)
D	DPI Indicator	250 PSIG (17 bar)	175°F (79°C)
G	DPG Gauge	500 PSIG (34 bar)	175°F (79°C)
N	No Accessories	500 PSIG (34 bar)	175°F (79°C)
W	Auto Drain and DPI Indicator	250 PSIG (17 bar)	175°F (79°C)
Y	Auto Drain and DPG Gauge	250 PSIG (17 bar)	175°F (79°C)

SN3L & SN4L Stainless Steel Compressed Air Filters

For the most demanding environments

Protect your equipment from contamination

Finite's stainless steel compressed air filters protect sensitive equipment and instruments from the dirt, water, and oil usually found in compressed air and other gases. These filters will remove contaminants at a very high efficiency - up to 99.995% for submicronic particles and droplets. Coalesced liquid drips off the filter cartridge to the drain as additional contamination enters the filter, allowing the filter to remove liquids without the loss of efficiency or flow capacity. These filters are constructed of 304 stainless steel and are designed to withstand the harshest environments.



Product Features:

- All 304 stainless steel construction
- Remove up to 99.995% of oil, water and solids from compressed air and other gases
- Continuously trap and drain liquids
- Remove trace amounts oil vapor with adsorbent cartridges

Applications:

- Refineries
- Chemical plants
- Steel and metal fabrication plants
- General industrial

Specifications:

Stainless Steel Housings	SN3L	SN4L
Port Size	3/4" NPT	1" NPT
Max Pressure	250 PSIG	250 PSIG
Height	4" W x 12" L	4" W x 12" L
Weight	14 lbs.	13 lbs.

SN3 & SN4L Materials	
Head	304 Stainless Steel
Bowl	304 Stainless Steel
Internals	Stainless Steel
Seals	Fluorocarbon
Drain Port	1/8" NPSM (auto drain option available)

Flow Rates:

Element Grade	SN3L/SN4L SCFM @ 100 PSIG
4	80
6	105
8	140
10	170
3PU	170
AU	105
100WSU	170

Part Numbers and Descriptions:

Part Numbers	Description	Port Size	Max. Temp
SN3L-*CUN	Coalescer	3/4" NPT	175°F
SN3L-*CUA	Coalescer with Auto Drain	3/4" NPT	120°F
SN3L-*HN	High Temp Coalescer	3/4" NPT	350°F
SN3L-*DSN	High Temp Coalescer (Metal Retained Element)	3/4" NPT	450°F
SN3L-3PUN	Particulate	3/4" NPT	175°F
SN3L-3PUA	Particulate with Auto Drain	3/4" NPT	120°F
SN3L-*GN	High Temp Particulate	3/4" NPT	350°F
SN3L-AUN	Carbon Adsorber	3/4" NPT	175°F
SN3L-100WSUN	Water Separator	3/4" NPT	175°F
SN3L-100WSUA	Water Separator with Auto Drain	3/4" NPT	120°F
SN4L-*CUN	Coalescer	1" NPT	175°F
SN4L-*CUA	Coalescer with Auto Drain	1" NPT	120°F
SN4L-*HN	High Temp Coalescer	1" NPT	350°F
SN4L-*DSN	High Temp Coalescer (Metal Retained Element)	1" NPT	450°F
SN4L-3PUN	Particulate	1" NPT	175°F
SN4L-3PUA	Particulate with Auto Drain	1" NPT	120°F
SN4L-*GN	High Temp Particulate	1" NPT	350°F
SN4L-AUN	Carbon Adsorber	1" NPT	175°F
SN4L-100WSUN	Water Separator	1" NPT	175°F
SN4L-100WSUA	Water Separator with Auto Drain	1" NPT	120°F

*Insert media grade 4, 6, 8 or 10. See Media Specifications chart.

Accessories:

Part Numbers	Description	Port Size	Max. Temp
2191	Mounting Bracket	All	-
FSA602MDSS	42800	Manual Drain	120°F

Media Specifications:

Media Grade	Coalescing Efficiency .3 to .6 Micron Particles	Max. Oil Carryover ¹ PPM w/w	Micron Rating	Pressure Drop (PSID) @ Rated Flow ²	
				Media Dry	Media Wet ⁵
4	99.995%	0.003	0.01	1.25	3-4
6	99.97%	0.008	0.01	1.0	2-3
8	98.5%	0.2	0.5	0.5	1-1.5
10	95%	0.85	1.0	0.5	0.5
3PU	n/a	n/a	3.0	0.25	n/a
AU	99+% ³	n/a	3.0	1.0	n/a
100WSU	99+% ⁴	n/a	100	<0.25	<0.25

¹Tested per ISO-12500-1 at 40 ppm inlet.

²Add dry + wet for total pressure drop.

³Oil vapor removal efficiency is given for A media.

⁴Bulk liquid removal efficiency.

⁵Media wet with 10–20 wt. oil.

Replacement Element Part Numbers:

Part Numbers	Description
*CU17-058 x 1	Coalescer
*H17-058 x 1	High Temp Coalescer
*DS17-058 x 1	High Temp Coalescer (Metal Retained Element)
3PU17-058 x 1	Particulate
*G17-058 x 1	High Temp Particulate
AU17-058 x 1	Carbon Adsorber
100WSU17-058 x 1	Water Separator

*Insert media grade 4, 6, 8 or 10.

See Media Specifications chart.

Compressed Air & Gas Water Separators

Remove bulk liquids from your application

Protect your equipment from contamination

Finite's new water separators have been designed for the efficient removal of bulk liquid contamination from compressed air. Today, many products are offered for the removal of bulk liquid from compressed air, however, these are often selected only based on their initial purchase cost, with little or no regard for the separation efficiency they provide or the cost of operation throughout their life. Finite's water separators have been designed from the ground up with the key design focus concentrated in critical areas such as air flow management, separation efficiency at all flow conditions, minimal pressure losses and independently validated performance.



Product Features:

- Tested in accordance with ISO 8573.9
- High liquid removal efficiencies at all flow conditions
- Low pressure losses for low operational costs
- Multiple port sizes for each flow rate provides increased flexibility during installation
- Low maintenance, light weight, aluminum housing

Applications:

- Bulk liquid removal at any point in a compressed air system
- Protection of refrigeration and adsorption dryer pre-filtration
- Liquid removal from compressor inter-coolers/after-coolers
- Liquid separation within refrigeration dryers

Product Selection and Technical Data

All connection sizes are NPT threaded. Auto drain is standard on all models.

Specifications

Part Number	Port Size (inches) NPT	SCFM at 100 PSIG	Max. Operating Pressure	Max. Operating Temp	Min. Operating Temp
WNA0025A	1/4"	25	230 PSIG	175°F	35°F
WNB0025A	3/8"	25	230 PSIG	175°F	35°F
WNC0025A	1/2"	25	230 PSIG	175°F	35°F
WNB0100A	3/8"	100	230 PSIG	175°F	35°F
WNC0100A	1/2"	100	230 PSIG	175°F	35°F
WND0100A	3/4"	100	230 PSIG	175°F	35°F
WNE0100A	1"	100	230 PSIG	175°F	35°F
WND0250A	3/4"	250	230 PSIG	175°F	35°F
WNE0250A	1"	250	230 PSIG	175°F	35°F
WNF0250A	1 1/4"	250	230 PSIG	175°F	35°F
WNG0250A	1 1/2"	250	230 PSIG	175°F	35°F
WNF0750A	1 1/4"	750	230 PSIG	175°F	35°F
WNG0750A	1 1/2"	750	230 PSIG	175°F	35°F
WNH0750A	2"	750	230 PSIG	175°F	35°F
WNI1700A	2 1/2"	1700	230 PSIG	175°F	35°F
WNJ1700A	3"	1700	230 PSIG	175°F	35°F

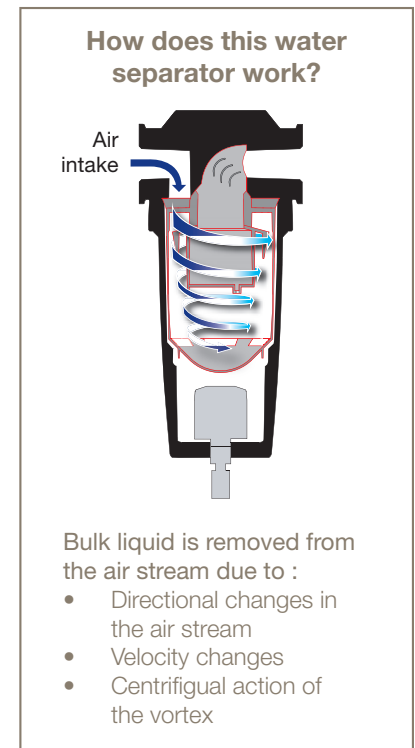

Dimensions and Weights

Part Number	Port Size (inches) NPT	Dimensions (inches)			Weight (lbs)
		A	B	C	
WNA0025A	1/4"	3	7.2	6	1.3
WNB0025A	3/8"	3	7.2	6	1.3
WNC0025A	1/2"	3	7.2	6	1.3
WNB0100A	3/8"	3.8	9.3	7.9	2.4
WNC0100A	1/2"	3.8	9.3	7.9	2.4
WND0100A	3/4"	3.8	9.3	7.9	2.4
WNE0100A	1"	3.8	9.3	7.9	2.4
WND0250A	3/4"	5.1	10.8	9.2	4.8
WNE0250A	1"	5.1	10.8	9.2	4.8
WNF0250A	1 1/4"	5.1	10.8	9.2	4.8
WNG0250A	1 1/2"	5.1	10.8	9.2	4.8
WNF0750A	1 1/4"	6.7	17	15	11.2
WNG0750A	1 1/2"	6.7	17	15	11.2
WNH0750A	2"	6.7	17	15	11.2
WNI1700A	2 1/2"	8.1	19.9	17.5	22
WNJ1700A	3"	8.1	19.9	17.5	22

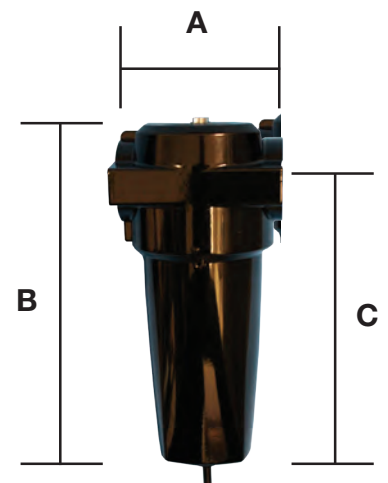





High Pressure and Alternative Fuel Filtration



ENGINEERING YOUR SUCCESS.

High Pressure Filtration

High pressure compressors are used in a variety of applications. Many owners, operators and designers of high pressure compressed air or gas systems rely on Finite for high-quality air treatment filters. End users of high pressure compressed air, such as scuba divers and fire rescue workers, depend on this high quality breathable air.

Throughout the stages of compression many contaminants can enter into the system. Excessive amounts of liquid aerosols and solid particulate contamination are common in high pressure systems. In addition, higher temperature levels are possible and may cause liquid oils to varnish. This contamination can lead to poor component performance and wear that may lead to unscheduled maintenance. Even submicronic contaminants in compressed air or gas systems can foul multistage compressors, increase maintenance costs or eventually make it into your final product.

Finite offers a variety of high pressure compressed air and gas filters. With our wide range of elements, we have a solution for every stage of compression, as well as at the point of use. Whether you are storing high pressure air or gas or using a continuous flow, you can count on Finite to protect your equipment from contamination. Finite is the solution to ending high pressure contamination fouling.



Alternative Vehicles Need High Pressure Filtration

Compressed Natural Gas, or CNG, is a leading alternative to traditional fuel for the automotive industry. CNG is used in passenger vehicles, pickup trucks, in transit and on school buses. It can be less expensive than gasoline, and is more environmentally friendly – it reduces the amount of carbon monoxide, carbon dioxide and hydrocarbon vehicle Exhaust emissions.

Natural gas is gathered from a pipeline and travels to a connecting

compressor station. The gas is elevated to pressures ranging from 2000 PSIG up to 5000 PSIG and the resultant CNG is stored in large tanks. The CNG then makes its way to a gas dispenser where it is ready for use in natural gas vehicles.

Contaminants can enter into the gas at any stage of this processing. Filters are critical at each stage to ensure clean gas as a final product. Contamination that collects during handling, water that condenses

in tanks and compressors that leak oil into the fuel stream are all problems that could shorten the life of expensive equipment, create unnecessary downtime and increase maintenance costs.

From pipeline to engine, Finite filters provide the critical filtration required for most alternative fuel systems. See page 59 for more detailed information on this application.

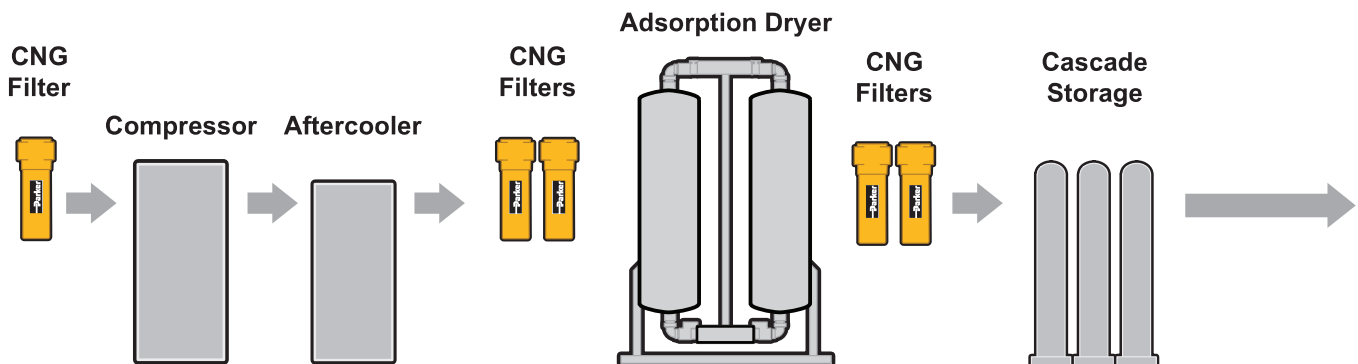

How to select your Finite Filter:

The following steps will help you to choose the correct filter for your application. If there are other factors involved or if you have special requirements, call one of Finite's application engineers.

Step 1: Determine your application

Evaluate the requirements of your application. The sketches on the following pages depict popular examples of breathing air, PET bottle blowing and alternative fuel applications.

Step 2: Choose your filtration media type

What type of filtration is needed? Coalescing filter media removes solid and liquid contaminants from gas streams. Particulate filter media removes solids from gas streams. Adsorber media removes hydrocarbon vapors from gas streams. See the following pages for more detailed information.

Step 3: Choose your filtration grade and efficiency

Are you searching for a specific micron rating... or efficiency rating? If so, page 79 provides a complete breakdown of Finite's filter media grades and their performance specifications.

Step 4: Consider your operating conditions

What are the operating conditions of your application? Key criteria to consider: flow, pressure, temperature, materials of construction (stainless steel, nylon, aluminum, etc.). samples throughout this section provide detailed descriptions of the various products available.

Step 5: Use flow charts to determine filter size

Flow charts are provided for each high pressure filter series. Flows are listed at various operating pressures. Filters are available with flows up to 6500 SCFM and pressure ratings up to 6000 PSIG.

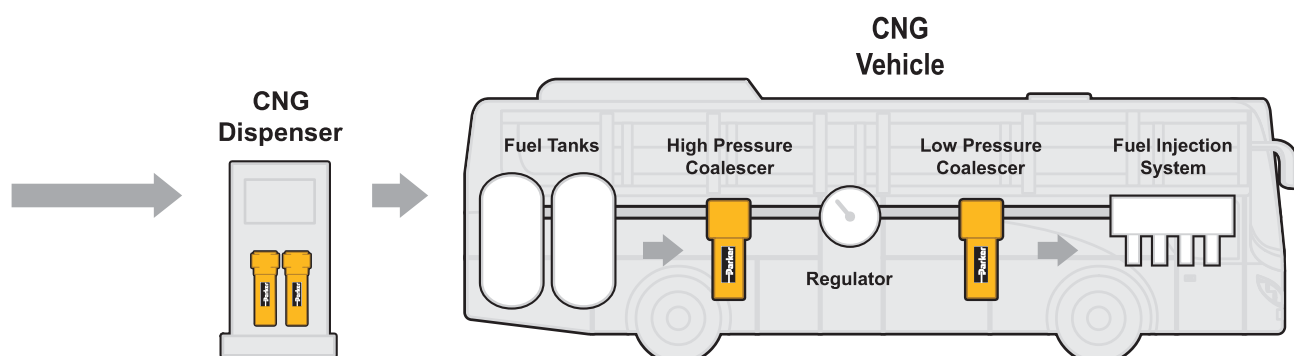

Applications

High Pressure Breathing Air

The filtration of compressed air is critical to ensure that it meets stringent air quality requirements for use in breathing air applications as set forth by North American agencies such as the Occupational Health and Safety Administration (OSHA) and Canadian Standards Association (CSA). Breathing air is used for scuba tanks, fire rescue equipment, and emergency

respiratory gear. Any contaminants in the air stream may cause equipment damage and malfunction, requiring costly repairs and replacements, and ultimately creating a hazardous situation for any users of high pressure breathing air apparatus. The use of filters will protect the consumer's health and keep equipment safe and fully operational. At the source, a

coalescing filter will remove any oil or other liquid contaminants that may be carried downstream. At the point of use, conventional compressed air must be free of impurities such as moisture, oil vapors and any harmful tastes and/or odors before it can safely be used as breathing air.

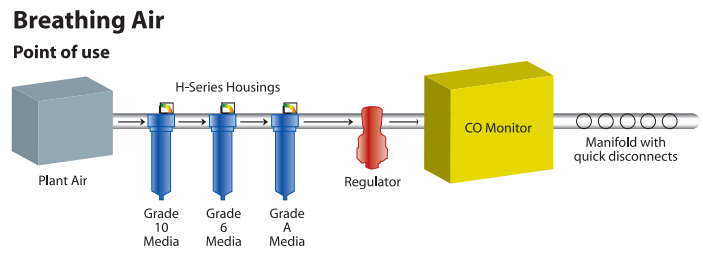
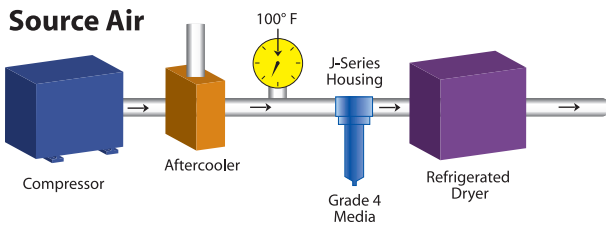

For more information on H-Series filters, please see Bulletin 1300-993C.



PET Blow Molding

PET, or polyethylene terephthalate, is a recyclable material used to make bottles by blow molding. Food and beverage containers are just a few of the many products that can be manufactured from this thermoplastic. In order to ensure that these products remain contaminant free throughout a process, they must be manufactured with clean, dry air. The proper combination of filters will prevent compressor oils, pipe scale and other damaging impurities from building up on equipment.

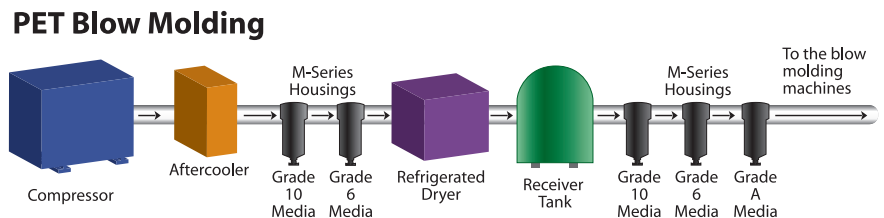

At the CNG Fueling Station

Installing a lower pressure particulate filter (H-Series Housing 3PU Media) before the compressor station will remove pipe scale to prevent compressor damage. Before the gas is transported from storage to the dispenser, prefiltration of the gas with two-stage coalescing will eliminate solids, oil and water generated during underground transit. For extra protection, a high efficiency coalescer should be placed at the gas dispenser to protect sensitive dispenser metering equipment and prevent oil from making its way into the vehicle.

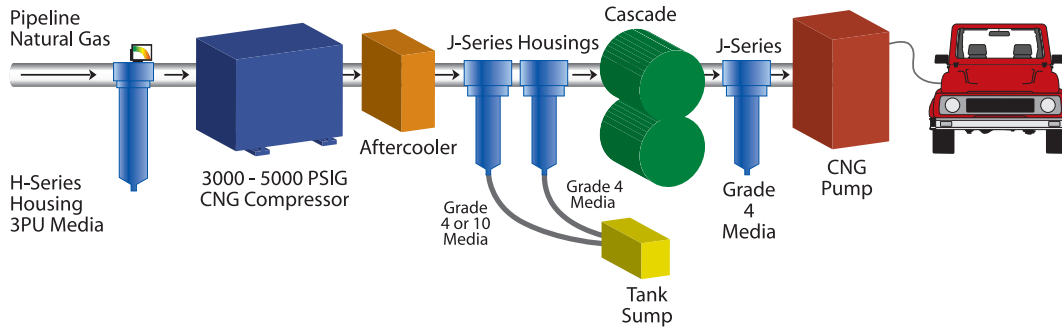

For more information on H-Series filters, please see Bulletin 1300-993C/USA.



Onboard CNG Vehicles

Filtration is the key to guarding against damaging contaminants that could ruin a fuel system. Installing a coalescer upstream of the high pressure regulator extends the system's life and reduces maintenance costs. A low pressure filter can also be used downstream of the regulator to protect other fuel injection system components.

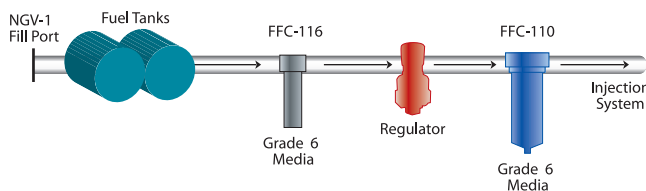





Other applications include:

- General high pressure compressed air
- High pressure testing
- Offshore applications
- High pressure gas storage
- Corrosive gases
- Specialty gases
- Air-blast circuit breakers
- Leak testing of hydraulic equipment
- Shipboard air distribution systems

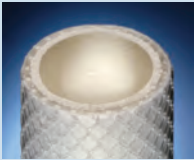
Media Types, Grades, and Efficiencies

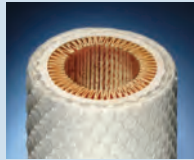
Coalescing elements are specially designed for the removal of liquid contaminants from gaseous flows. These media types flow from the inside of the element to the outside. Coalesced liquid (water and oil) collects in the bowl where it is drained, while clean air or gas exits the housing through the outlet port. Particulate contaminants are captured and held in the media.

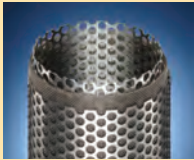
Coalescing Elements (removal of liquids and particulate)				Water Separator Element (removal of bulk liquids)
				
Media Type C	Media Type H	Media Type Q	Media Type 7CVP	Media Type 100WS
Coalescing element composed of an epoxy saturated, borosilicate glass microfiber tube in intimate interlocking contact with a rigid retainer. Surrounded by a coarse fiber drain layer, retained by a synthetic fabric safety layer. Some models are available with molded elastomeric end seals (CU), or with metal end caps and fluorocarbon gaskets.	Coalescing element similar to type "C," however no rigid retainer is used. Typically used in applications with low or constant flow rates.	Coalescing element with the same configuration as "C" tube, but with "3P" type pleated cellulose prefilter built-in. Includes molded elastomeric end seals (QU). Some models offer the option of metal end caps and fluorocarbon gaskets.	Coalescing element made of pleated glass media. Metal retained for added strength. Includes metal end caps and fluorocarbon gaskets for proper sealing. Only available in Grade 7.	This all stainless steel element has two metal retainers with rolled mesh screen in between. This cleanable element combines liquid droplets and aerosols, separating the liquids from the gas stream in systems with high liquid loads.
For use with:	For use with:	For use with:	For use with:	For use with:
<ul style="list-style-type: none"> • FFC-110 (800 PSIG) • FFC-110L (800 PSIG) • SN8S (500 PSIG) • M-Series (800 PSIG) • A5R/A1R (1000 PSIG) • SM-Series (1200 PSIG) • FFC-112 (3600 PSIG) • FFC-112 SAE (3600 PSIG) • FFC-113 (3600 PSIG) • J-Series (5000 PSIG) • S5R/S1R (5000 PSIG) • FFC-116 (5000 PSIG) • SJ-Series (6000 PSIG) 	<ul style="list-style-type: none"> • A5R/A1R (1000 PSIG) • SM-Series (1200 PSIG) • S5R/S1R (5000 PSIG) 	<ul style="list-style-type: none"> • M-Series (800 PSIG) • SM-Series (1200 PSIG) 	<ul style="list-style-type: none"> • SN8S (500 PSIG) • M-Series (800 PSIG) 	<ul style="list-style-type: none"> • SN8S (500 PSIG) • M-Series (800 PSIG) • J-Series (5000 PSIG) • SJ-Series (6000 PSIG)

Media Grades:

Grade 4

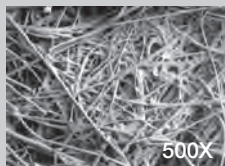

Grade 4 filter elements are very high efficiency coalescers; for elevated pressures or lighter weight gases. Recommended when system pressure exceeds 500 PSIG.

Grade 6

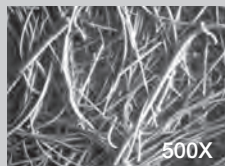

Grade 6 filter elements are used when "total removal of liquid aerosols and suspended fines" is required. Because of its overall performance characteristics, this grade is most often recommended below 500 PSIG.

Grade 7CVP

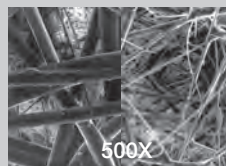

Grade 7CVP filter elements are made with two layers. The inner layer (left) effectively traps dirt particles, protecting and extending the life of the outer layer. The coalescing outer layer (right) consists of a dense matrix of glass fibers, providing highly efficient aerosol removal.

Grade 8

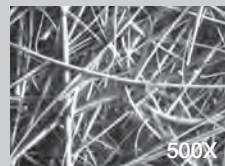

Grade 8 filter elements provide high efficiency filtration in combination with high flow rate and long element life.



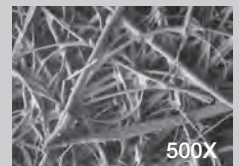



Grade 10



Grade 10 filters are used as prefilters for grade 6 to remove gross amounts of aerosols or tenacious aerosols which are difficult to drain. This grade is often used as a 'coarse' coalescer.

Particulate filters such as G, F, T and 3P flow from the outside of the element to the inside. Particles collect in the element, while the clean air exits through the outlet port.

Adsorption elements are used to remove vapors (hydrocarbon or water) that are not removed by the coalescing filter. Hydrocarbon vapors collect in the element, while clean air exits the housing through the outlet port. In this element, the air or gas flows from the outside of the element to the inside.

Particulate Removal Element (removal of solids)				Adsorption Element (removal of odors)	Liquid Propane Element (removal of particulates)
					
Media Type 3P	Media Type G	Media Type F	Media Type T	Media Type A	Media Type LPG
<p>Pleated cellulose particulate removal element. Includes molded elastomeric end seals (3PU). Some models offer the option of metal end caps and fluorocarbon gaskets.</p> <p>For use with:</p> <ul style="list-style-type: none"> • SN8S (500 PSIG) • M-Series (800 PSIG) • SM-Series (1200 PSIG) • J-Series (5000 PSIG) • SJ-Series (6000 PSIG) 	<p>Particulate removal element constructed of the same fiber matrix as type "C", but with no rigid retainer or drain layer.</p> <p>For use with:</p> <ul style="list-style-type: none"> • A5R/A1R (1000 PSIG) • SM-Series (1200 PSIG) • S5R/S1R (5000 PSIG) • S1IL (5000 PSIG) 	<p>Particulate removal element like "G" tube, except fluorocarbon saturant replaces epoxy.</p> <p>For use with:</p> <ul style="list-style-type: none"> • A5R/A1R (1000 PSIG) • SM-Series (1200 PSIG) • S5R/S1R (5000 PSIG) • S1IL (5000 PSIG) 	<p>Particulate removal element like "G" tube, except high temperature fluorocarbon saturant replaces epoxy.</p> <p>For use with:</p> <ul style="list-style-type: none"> • A5R/A1R (1000 PSIG) • SM-Series (1200 PSIG) • S5R/S1R (5000 PSIG) • S1IL (5000 PSIG) 	<p>Hydrocarbon vapor removal element. Ultrafine grained, highly concentrated, activated carbon sheet media. Includes molded elastomeric end seals (AU). Some models offer the option of metal end caps and fluorocarbon gaskets. Maximum hydrocarbon inlet concentration .5 to 2 PPM.</p> <p>For use with:</p> <ul style="list-style-type: none"> • SN8S (500 PSIG) • M-Series (800 PSIG) • SM-Series (1200 PSIG) • J-Series (5000 PSIG) • SJ-Series (6000 PSIG) 	<p>High efficiency pleated element that is offered in either a 1-micron or 5-micron rating. The pleated element construction guarantees a long filter life and the pleated media is backed on both sides by a rugged epoxy coated steel screen for high strength during peak flow rate conditions.</p>

Parker Finite Media Specifications

Finite media grades determine the filtration efficiency. Capture efficiencies are available up to 99.995%.

Micron ratings range from 0.01 to 3 micron. The columns on the right note both the wet and dry pressure drops.

Grade 3P

Grade A

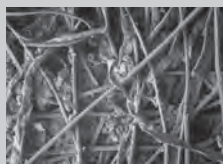
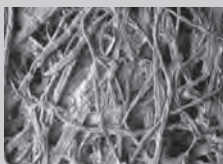

Three micron pleated cellulose filters are used for particulate interception where very high dirt holding capacity and a relatively fine pore structure are required.

A (Adsorption) filters are used to remove hydrocarbon vapor, most typically in preparation for breathing air. (Must be preceded by grade 6C coalescer.)

Media Grade	Coalescing Efficiency 0.3 to 0.6 Micron Particles	Maximum Oil Carryover ¹ PPM w/w	Micron Rating	Pressure Drop (PSID) @ Rated Flow ²	
				Media Dry	Media Wet ⁵
4	99.995%	0.003	0.01	1.25	3-4
6	99.97%	0.008	0.01	1.0	2-3
ME	99.95%	0.02	0.3	0.5	1.0
7	99.5%	0.09	0.5	0.25	0.5-0.7
8	98.5%	0.2	0.5	0.5	1-1.5
10	95%	0.85	1.0	0.5	0.5
100WS	99+ ³	N/A	100	< 0.25	< 0.25
3P	N/A	N/A	3.0	0.25	N/A
A	99+ ⁴	N/A	3.0	1.0	N/A

¹Tested per ISO 12500-1 at 40 ppm inlet.

²Add dry + wet for total pressure drop.

³Bulk liquid removal efficiency.

⁴Oil vapor removal efficiency is given for A media.

⁵Media wet with 10-20 wt. oil

H-Series Filters

1-1/4" to 3" Port Size

500 PSIG Pressure Filters

- Pressures to 500 PSIG
- Coalescing, particulate and adsorption elements available
- Connections from 1/4" to 3"
- Flows from 190 to 1600 SCFM (@ 100 psig)
- Temperatures to 450° F
- Manual drains only should be used with flammable gases
- Media types available: C or Q (grades 4, 6 and 10), 7CVP, 3P & 100WS (See below)
- 1/4" thru 1" port sizes should not be used for Natural Gas applications (see "M" Series for these applications)



See the "H-Series" filters in the "Compressed Air and Gas Filtration" section of this catalog for further information.

SN8S High Flow Filter (Stainless Steel)

500 PSIG Pressure Filters

Parker Finite’s 500 PSIG SN8S filter is the best solution for most critical or corrosive compressed air/ gas applications. Its 2" NPT stainless steel housing is a perfect fit for food processing, bottling plants and pharmaceutical manufacturing, where stainless steel system components are required. Bulk liquid from gas separation, oil coalescing, particulate removal and vapor adsorber filter elements are available. The housing has a plugged 1/4" NPT drain connection. The optional ADS-50 (see “Accessories” section of this catalog) stainless steel auto drain can be easily connected with standard pipe fittings. Bottling plants use stainless steel system components for their critical processes. In applications where stainless steel is required, use the SN8S to remove contaminants from your compressed air or gas system.



Specifications:

Model Number	Port Size (NPT)	Max. Pressure	Max. Temp. for each Element Type	Materials of Construction			Seals	Sump Capacity	Weight	Dimensions	
				Body	Internals	Bowl				Length	Width
SN8S	2"	500 PSIG (34 bar)	175°F(CU, 3PU, AU), 175°F(7CVP), 175°F (100WS), 175°F (DS)	316 Stainless Steel	316 Stainless Steel	316 Stainless Steel	Fluoro-carbon	14.6 oz (431.8 ml)	32.0 lbs (14.5 kg)	27.7" (703.6 mm)	6.3" (160.0 mm)

Flow Rates (SCFM):

Model	Media Grade	100 PSIG	250 PSIG	500 PSIG
SN8S	4CU/4DS	340	785	1526
	6CU/6DS	450	1038	2019
	8CU/8DS	600	1385	2692
	10CU/10DS	750	1731	3366
	3PU	750	1731	3366
	AU	450	1038	2019
	7CVP	750	1731	3366
	100WS	750	1731	3366

How to Order:

SN8S X 1
Standard
SN8S X 1

How to Order Replacement Elements:

Element and housing sold separately. Elements available (one per Box):

- *CU24-187 X 1
- *DS24-187 X 1
- 3PU24-187 X 1
- AU24-187 X 1
- 7CVP24-187 X 1
- 100WS24-187 X 1

*Insert grade: 4, 6, 8, 10

Example: 6CU24-187 X 1

M-Series Filters

800 PSIG Pressure Filters

Parker Finite's M-Series provides the needed filtration for a wide variety of compressed air/ gas applications. Varied porting and connection styles, along with a robust design make this an extremely versatile filter. It is a perfect fit for interstage filtration applications for multistage, high pressure gas compressors. The aluminum heads and drawn aluminum bowls are compatible with special gases such as argon, hydrogen, compressed natural gas, and helium. This housing design minimizes the problem of porosity often present with housings made by die casting.

PET bottle blowing plants rely on the filtration protection of the M-Series to meet stringent standards for contact with food and beverage containers.



Specifications:

Model Number	Port Size NPT	Max. Pressure	Max. Temp.	Materials of Construction			Seals	Sump Capacity	Weight	Dimensions	
				Head	Internals	Bowl				Length	Width
MN1S	1/4"	800 PSIG (55 bar)	175°F (79°C)	Machined Aluminum	Stainless Steel/ Plastic	Aluminum	Buna-N	5.1 oz (150 ml)	1.83 lbs (0.83 kg)	7.89" (200 mm)	3.06" (78 mm)
MN1L	1/4"	800 PSIG (55 bar)	175°F (79°C)	Machined Aluminum	Stainless Steel/ Plastic	Aluminum	Buna-N	4.7 oz (140 ml)	2.19 lbs (0.99 kg)	10.28" (261 mm)	3.06" (78 mm)
MN15S	3/8"	800 PSIG (55 bar)	175°F (79°C)	Machined Aluminum	Stainless Steel/ Plastic	Aluminum	Buna-N	5.1 oz (150 ml)	1.82 lbs (0.82 kg)	7.89" (200 mm)	3.06" (78 mm)
MN15L	3/8"	800 PSIG (55 bar)	175°F (79°C)	Machined Aluminum	Stainless Steel/ Plastic	Aluminum	Buna-N	4.7 oz (140 ml)	2.17 lbs (0.98 kg)	10.28" (261 mm)	3.06" (78 mm)
MN2S	1/2"	800 PSIG (55 bar)	175°F (79°C)	Machined Aluminum	Stainless Steel/ Plastic	Aluminum	Buna-N	5.1 oz (150 ml)	1.80 lbs (0.82 kg)	7.89" (200 mm)	3.06" (78 mm)
MN2L	1/2"	800 PSIG (55 bar)	175°F (79°C)	Machined Aluminum	Stainless Steel/ Plastic	Aluminum	Buna-N	4.7 oz (140 ml)	2.15 lbs (0.98 kg)	10.28" (261 mm)	3.06" (78 mm)
MN3S	3/4"	800 PSIG (55 bar)	175°F (79°C)	Machined Aluminum	Stainless Steel/ Plastic	Aluminum	Buna-N	9.1 oz (270 ml)	5.01 lbs (2.27 kg)	10.83" (275 mm)	4.55" (116 mm)
MN4S	1"	800 PSIG (55 bar)	175°F (79°C)	Machined Aluminum	Stainless Steel/ Plastic	Aluminum	Buna-N	9.1 oz (270 ml)	4.90 lbs (2.22 kg)	10.83" (275 mm)	4.55" (116 mm)
MN4L	1"	800 PSIG (55 bar)	175°F (79°C)	Machined Aluminum	Stainless Steel/ Plastic	Aluminum	Buna-N	9.1 oz (270 ml)	5.54 lbs (2.51 kg)	14.36" (365 mm)	4.55" (116 mm)
MN8S	2"	800 PSIG (55 bar)	175°F (79°C)	Sand Cast Aluminum	Aluminum	Aluminum	Buna-N	14.9 oz (440 ml)	10.37 lbs (4.71 kg)	18.60" (472 mm)	5.91" (150 mm)

How to Order:

M	N	2	S	-				6	Q	U	G
Series Name	Port Type	Port Size	Bowl	Media Grade	Media Type	End Seal	Accessories				
M	N (NPT)	1 (1/4") 15 (3/8") 2 (1/2") 3 (3/4") 4 (1") 8 (2")	S (Standard) L (Long) Note: L is not available for 3/4" and 2" port size housings	4	C (Coalescer)	1/4" - 1" port size: Leave blank for no end seal or U (Urethane)	N (No Accessories) G (Gauge)  Option (G) is a great way to monitor pressure drop and determine when to replace the filter element.				
				6 8 10				Q (Coalescer with built-in pre-filter)	U (Urethane) Standard on all sizes		
				Leave blank	100WS	1/4" - 1" port size: U (Urethane) For 2" leave blank (standard fluorocarbon end seals)					
				Leave blank	7CVP (only available on 2" port)	Leave blank (standard fluorocarbon end seals)					
				Leave blank	3P (Pleated Cellulose) Particulate element	1/4" - 1" port size: U (Urethane) 2" port size: V (Fluorocarbon)					
				Leave blank	A (Adsorber)	1/4" - 1" port size: U (Urethane) 2" port size: V (Fluorocarbon)					
	S (SAE)*										
	*SAE -32 2" connection only	8 (SAE -32)									

Examples: MN2S-6QUG, MN3S-3PUN, MN8S-6CVG, MN8S-7CVPG

Mounting brackets available: MB-2 (1/4" - 1/2" port size) and BK-3 (3/4" - 1" port size)

How to Order Replacement Elements:

Housings are sold with one element. Build your own replacement element with the chart below:

Housing (_ Port Type)	Media Grade and Type	Element Size
M_1S M_15S M_2S	*C,*CU,*QU, 3PU, AU, 100WSU	10-025
M_1L M_15L M_2L	*C,*CU,*QU, 3PU, AU, 100WSU	10-050 (for 100WSU use 10-025)
M_3S M_4S	*C,*CU,*QU, 3PU, AU, 100WSU	15-060
M_4L	*C,*CU,*QU, 3PU, AU, 100WSU	15-095 (for 100WSU use 15-060)
M_8S	*CV,*QU, 3PV, AV, 100WS, 7CVP	25-130

- Determine the housing you have by choosing from the "Housing" column on the chart.
- Determine the element type and grade you need.
*Insert grades 4,6,8, or 10 for C, CU, CV, or QU.
- Determine the corresponding element size by choosing from the "Element Size" column on the chart.
- Combine "Element Grade and Type" designation with "Element Size" to get element part number.

Examples: 3PU10-025, 6CU10-025

Element Box quantity depends on media type selected.



Note: "_" insert port type from "How to Order" section above.

M-Series Flow Rates (SCFM):

Filter Housing	Media Grade	100 PSIG	250 PSIG	500 PSIG	800 PSIG
M_1S	4C/4Q	11	25	49	78
	6C/6Q	15	35	67	107
	7CVP	NA	NA	NA	NA
	8C/8Q	20	46	90	142
	10C/10Q	25	58	112	178
	3P	25	58	112	178
	100WS	50	115	224	355
	A	15	35	67	107
M_1L	4C/4Q	23	53	103	163
	6C/6Q	30	69	135	213
	7CVP	NA	NA	NA	NA
	8C/8Q	41	95	184	291
	10C/10Q	50	115	224	355
	3P	50	115	224	355
	100WS	50	115	224	355
	A	30	69	135	213
M_15S	4C/4Q	15	35	67	107
	6C/6Q	20	46	90	142
	7CVP	NA	NA	NA	NA
	8C/8Q	27	62	121	192
	10C/10Q	33	76	148	235
	3P	33	76	148	235
	100WS	66	152	296	469
	A	20	46	90	142
M_15L	4C/4Q	30	69	135	213
	6C/6Q	40	92	179	285
	7CVP	NA	NA	NA	NA
	8C/8Q	55	127	247	391
	10C/10Q	66	152	296	469
	3P	66	152	296	469
	100WS	66	152	296	469
	A	40	92	179	285
M_2S	4C/4Q	19	44	85	135
	6C/6Q	25	57	112	178
	7CVP	NA	NA	NA	NA
	8C/8Q	34	78	153	242
	10C/10Q	42	97	189	299
	3P	42	97	189	299
	100WS	83	192	372	590
	A	25	58	112	178

Filter Housing	Media Grade	100 PSIG	250 PSIG	500 PSIG	800 PSIG
M_2L	4C/4Q	38	88	171	270
	6C/6Q	50	115	224	355
	7CVP	NA	NA	NA	NA
	8C/8Q	68	157	305	483
	10C/10Q	83	192	372	590
	3P	83	192	372	590
	100WS	83	192	372	590
	A	50	115	224	355
M_3S	4C/4Q	61	141	274	434
	6C/6Q	80	185	359	569
	7CVP	NA	NA	NA	NA
	8C/8Q	109	252	489	775
	10C/10Q	133	307	597	946
	3P	133	307	597	946
	100WS	133	307	597	946
	A	80	184	359	569
M_4S	4C/4Q	76	175	341	541
	6C/6Q	100	231	449	711
	7CVP	NA	NA	NA	NA
	8C/8Q	136	314	610	967
	10C/10Q	166	383	745	1181
	3P	166	383	745	1181
	100WS	232	535	1041	1650
	A	100	231	449	711
M_4L	4C/4Q	106	245	476	754
	6C/6Q	140	323	628	995
	7CVP	NA	NA	NA	NA
	8C/8Q	191	441	857	1358
	10C/10Q	232	535	1041	1650
	3P	232	535	1041	1650
	100WS	232	535	1041	1650
	A	140	323	628	995
M_8S	4C/4Q	260	600	1167	1849
	6C/6Q	350	808	1571	2489
	7CVP	600	1385	2692	4267
	8C/8Q	465	1073	2087	3307
	10C/10Q	600	1385	2692	4267
	3P	600	1385	2692	4267
	100WS	600	1385	2692	4267
	A	350	808	1571	2489

Note: “_” insert port type from the “How to Order” section on the previous page 65 for more information.

FFC-110 Series Filters

800 PSIG Pressure Filters

Parker Finite’s FFC-110 Series is often used onboard CNG (compressed natural gas) powered vehicles to prevent contaminants in the fuel tank from getting into the engine, protecting critical engine components, like fuel injectors. Its small size and lightweight allow for versatile installation and easy servicing. Each housing is black powder painted for long-term corrosion protection. These coalescers are ideal for operating environments up to 800 PSIG. Coalescing efficiencies of 95% (grade 10) or 99.97% (grade 6) can be chosen to match the filter to the application. Both the FFC-110 and FFC-110L have an 1/8" NPT drain port with a brass petcock manual drain.



Specifications:

Model Number	Port Size NPT	Max. Pressure	Max. Temp.	Materials of Construction			Seals	Sump Capacity	Weight	Dimensions	
				Head	Internals	Bowl				Length	Width
FFC-110	1/4"	800 PSIG (55 bar)	221°F (105°C)	Chromated Aluminum	Stainless Steel & Plastic	Chromated Aluminum	Fluorocarbon	5.1 oz (150 ml)	1.5 lbs (0.68 kg)	7.8" (198.1 mm)	3.1" (78.7 mm)
FFC-110L	1/2"	800 PSIG (55 bar)	221°F (105°C)	Chromated Aluminum	Stainless Steel & Plastic	Chromated Aluminum	Fluorocarbon	4.7 oz (140 ml)	1.8 lbs (0.82 kg)	10.2" (259.1 mm)	3.1" (78.7 mm)

Flow Rates (SCFM):

Model	Media Grade	100 PSIG	250 PSIG	500 PSIG	800 PSIG
FFC-110	6	15	35	67	107
	10	25	58	112	178
FFC-110L	6	50	115	224	355
	10	83	192	372	590

How to Order:

FFC-110	L	6
Series Name	Bowl	Media Grade
FFC-110	Omit for standard L (Long)	6 10

Example: FFC-110-6 or FFC-110L-6

Mounting Bracket Kit: 2222FFC

Kit includes bracket and 2 cap screws.

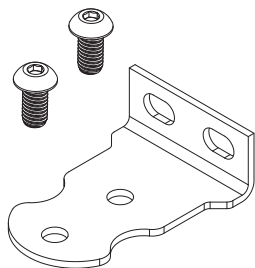

Replacement Element Kits:

Filter Housing Model	Media Grade 6	Media Grade 10
FFC-110	CLS110-6K	CLS110-10K
FFC-110L	CLS110-6LK	CLS110-10LK

Replacement Element Kits include element, head-to-bowl o-ring, and lubricant.

Certification:

ECE-R110

A5R & A1R Series Filters

1000 PSIG Pressure Filters

This 1000 PSIG filter is constructed of lightweight aluminum and offers your choice of high efficiency particulate and coalescing filter elements. This product can be used for CNG or specialty gas applications. The A5R and A1R include a drain port with a plug. The connection size of the drain port matches the inlet and outlet connection size, making it ideal for bypass gas sampling of specialty gases.



*Specify part number A5R for 1/8" NPT connections or A1R for 1/4" NPT connections.

Specifications:

Model Number	Port Size NPT	Max. Pressure	Max. Temp.	Materials of Construction			Seals	Sump Capacity	Weight	Dimensions	
				Head	Internals	Bowl				Length	Width
A5R, A1R	1/8", 1/4"	1000 PSIG (68 bar)	225°F All Media Types	Aluminum	316 Stainless Steel	Aluminum	Fluorocarbon	0.25 oz (7.4 ml)	0.75 lbs (0.34 kg)	4.0" (101.6 mm)	1.75" (44.5 mm)

Flow Rates (SCFM):

Model	Media Grade	100 PSIG	250 PSIG	500 PSIG	750 PSIG	1000 PSIG
A5R/A1R	4	6.4	15	29	43	57
	6	8.4	19	38	56	75
	8	9.2	21	41	61	81
	10	10	23	45	67	88

How to Order:

A	1	R	—	6	C	04-23
Series Name	Port Size NPT			Media Grade	Media Type	Element Size
A	5 (1/8") 1 (1/4")	R		4 6 8 10	G T F H C	04-023

Example: A1R-6C04-023

Mounting bracket available: MBS-1

How to Order Replacement Elements:

Elements available: _ insert grade: 4, 6, 8, 10
 _G04-023 X 10
 _T04-023 X 10
 _F04-023 X 10
 _H04-023 X 10
 _C04-023 X 10

For more information on element selection, please see pages 60-61. Elements are sold in Box quantities of 10.

SM-Series Filters

1200 PSIG Pressure Filters

Finite's stainless steel SM-Series housings are perfect for higher-pressure applications in corrosive working environments. Coalescing, particulate and adsorption filters are available. A threaded collar enables the user to easily remove the bowl for servicing, without having to remove the drain fitting and connections. The SM-Series has an SAE-4 drain port with plug.

Critical gas processing applications at elevated pressures rely on the SM-Series to provide clean, contaminant-free gas in corrosive environments.



Specifications:

Model Number	Port Size (NPT)	Max. Pressure	Max. Temp. for each Element Type	Materials of Construction			Seals	Sump Capacity	Weight	Dimensions	
				Head	Internals	Bowl				Length	Width
SMN1S, SMN2S	1/4", 1/2"	1200 PSIG (83 bar)	450°F (T) 350°F (H, G) 275°F (F) 175°F (C, CU, QU, 3PU, AU)	316 Stainless Steel	316 Stainless Steel	316 Stainless Steel	Fluoro-carbon	1.8 oz (53.23 ml)	3.6 lbs (1.6 kg) .75 lbs/.34 kg	5.2" (132 mm)	3.0" (76 mm)
SMN1M, SMN2M	1/4", 1/2"	1200 PSIG (83 bar)	450°F (T) 350°F (H, G) 275°F (F) 175°F (C, CU, QU, 3PU, AU)	316 Stainless Steel	316 Stainless Steel	316 Stainless Steel	Fluoro-carbon	1.8 oz (53.23 ml)	4.7 lbs (2.1 kg)	7.7" (196 mm)	3.0" (76 mm)
SMN1L, SMN2L	1/4", 1/2"	1200 PSIG (83 bar)	450°F (T) 350°F (H, G) 275°F (F) 175°F (C, CU, QU, 3PU, AU)	316 Stainless Steel	316 Stainless Steel	316 Stainless Steel	Fluoro-carbon	1.8 oz (53.23 ml)	5.7 lbs (2.6 kg)	9.7" (246 mm)	3.0" (76 mm)

SM-Series Flow Rates (SCFM):

Filter Housing Model	Media Grade	100 PSIG	250 PSIG	500 PSIG	750 PSIG	1000 PSIG	1200 PSIG	Filter Housing Model	Media Grade	100 PSIG	250 PSIG	500 PSIG	750 PSIG	1000 PSIG	1200 PSIG
SMN1S	4	10	23	45	67	88	106	SMN2S	4	16	37	72	107	142	169
	6	13	30	58	87	115	138		6	22	51	99	147	195	233
	8	17	39	76	113	150	181		8	29	67	130	193	257	307
	10	22	51	99	147	195	233		10	37	85	166	247	327	392
	3PU	22	51	99	147	195	243		3PU	37	85	166	247	327	392
	AU	13	30	58	87	115	138		AU	22	51	99	147	195	233
SMN1M	4	20	46	90	133	177	212	SMN2M	4	32	74	144	213	283	339
	6	26	60	117	173	230	275		6	43	99	193	287	380	456
	8	34	78	153	227	301	360		8	58	134	260	387	513	615
	10	44	102	197	293	389	466		10	74	171	332	493	655	784
	3PU	44	102	197	293	389	466		3PU	74	171	332	493	655	784
	AU	26	60	117	173	230	275		AU	43	99	193	287	380	456
SMN1L	4	28	65	126	187	248	296	SMN2L	4	45	104	202	300	398	477
	6	36	83	162	240	318	382		6	60	138	269	400	531	635
	8	47	108	211	313	416	498		8	81	187	363	540	717	858
	10	62	143	278	413	548	657		10	104	240	467	693	920	1102
	3PU	62	143	278	413	548	657		3PU	104	240	467	693	920	1102
	AU	36	83	162	240	318	382		AU	60	138	269	400	531	635

How to Order:

SM	N	1	M	—	6	C		N
Series Name	Port Type	Port Size	Bowl		Element Grade	Element Type	End Seal	Accessories
SM	N (NPT)	1 (1/4") 2 (1/2")	S (Short) M (Medium) L (Long)		4 6 8 10 Leave blank	C (Coalescer) Q (Coalescer with built-in prefilter) G T F H 3P (Pleated Cellulose) Particulate Element	Leave blank for no end seal (Available on type G,T,F,H,C) U (Urethane end seals, available on types C,Q,3P,A)	N (No Accessories)
					Leave Blank	A (Adsorber)		

Examples: SMN2S-8GN, SMN1L-6CUN, SMN2M-3PUN, SMN1M-AUN

Mounting bracket available: MBS-2

How to Order Replacement Elements:

Housing	Element Grade and Type	Element Size
SMN1S, SMN2S	*C, *CU, *QU, *H, *F, *G, *T, 3PU, AU	10-025
SMN1M, SMN2M	*C, *CU, *QU, *H, *F, *G, *T, 3PU, AU	10-050
SMN1L, SMN2L	*C, *CU, *QU, *H, *F, *G, *T, 3PU, AU	10-070

1. Determine the housing you have.
2. Determine the element type and grade you need. *Insert grades 4,6,8 or 10. See pages 60-61 for more detail on grade selection.
3. Determine the corresponding element size.
4. Combine “Element grade and Type” designation with “Element Size” to get part number. For Example: 6QU10-050. Box quantity depends on media type selected.

FFC-112 Series Filters

3600 PSIG Pressure Filters

Compressed Natural Gas (CNG) powered vehicles such as airport shuttles, delivery vehicles, medium and light duty trucks and buses, taxis, and passenger vehicles have come to rely on the Parker Finite FFC-112 Filter Series to protect critical engine components from contamination present in CNG fuel.

The submicronic solid and lubricant aerosols that may be carried over during CNG compression process as well as contaminants that can be generated by the storage and distribution of the natural gas, must be removed to protect the fuel injectors and pressure reducing valves onboard CNG vehicles. The FFC-112 Filter Series offers two Coalescing efficiencies of 95% (Grade 10) or 99.97% (Grade 6) to meet your filtration requirements. Both ¼" NPT and SAE-6 port connections are available in the FFC-112 Filter Series and the housing is rated for 3600 psig (248 barg). It is small in size, yet the robust lightweight aluminum design allows for versatile installation and easy servicing. The housing is anodized for long life and corrosion resistance in the harshest of operating environments.

There are two variations of the FFC-112 Filter Series available. The FFC-112L includes a longer bowl with no drain plug, while the Extended bowl (FFC-112E) includes a longer bowl along with the same stainless steel SAE-6 ported drain plug as the standard FFC-112. These versions with the longer bowls have up to 5 times the sump capacity of the standard FFC-112 filter housing for those applications where liquid contamination is a problem.

Features and Benefits:

- Protects critical engine components such as fuel injectors and regulators
- Three different variations
- Standard length with drain plug (FFC-112)
- E-Extended bowl with drain plug (FFC-112E)
- L-Long bowl with no drain plug (FFC-112L)
- Robust anodized aluminum construction can withstand harsh operating environments
- Two different coalescing efficiencies available, 95% (Grade 10) and 99.97% (Grade 6)
- Large sump capacity
- Small, lightweight size
- ¼" NPT and SAE port sizes
- Mounting bracket kit available
- ECE-R110 Certified Standard (FFC-112) and Long Bowl (FFC-112L)



Specifications:

Model Number	Port Size	Max. Pressure	Max. Temp.	Materials of Construction			Seals	Sump Capacity	Weight	Dimensions	
				Head	Internals	Bowl				Length	Width
FFC-112	1/4" NPTF	3600 PSIG (248 barg)	221°F (105°C)	Anodized Aluminum	Nylon Micro-glass	Anodized Aluminum	Fluorocarbon	0.5 oz (15 cc)	1.1 lbs (0.5 kg)	4.73" (120.1 mm)	2.28" (57.8 mm)
FFC-112-SAE	SAE-6	3600 PSIG (248 barg)	221°F (105°C)					0.5 oz (15 cc)	1.1 lbs (0.5 kg)	4.73" (120.1 mm)	2.28" (57.8 mm)
FFC-112E	1/4" NPTF	3600 PSIG (248 barg)	221°F (105°C)					2.5 oz (75 cc)	1.9 lbs (0.9 kg)	8.48" (215.4 mm)	2.28" (57.8 mm)
FFC-112E-SAE	SAE-6	3600 PSIG (248 barg)	221°F (105°C)					2.5 oz (75 cc)	1.9 lbs (0.9 kg)	8.48" (215.4 mm)	2.28" (57.8 mm)
FFC-112L	1/4" NPTF	3600 PSIG (248 barg)	221°F (105°C)					2.5 oz (75 cc)	1.9 lbs (0.9 kg)	8.48" (215.4 mm)	2.28" (57.8 mm)
FFC-112L-SAE	SAE-6	3600 PSIG (248 barg)	221°F (105°C)					2.5 oz (75 cc)	1.9 lbs (0.9 kg)	8.48" (215.4 mm)	2.28" (57.8 mm)

Flow Rates (SCFM):

SCFM in Natural Gas												
Filter Housing Model	Media Grade	Coalescing Efficiency	100 PSIG	250 PSIG	500 PSIG	750 PSIG	1000 PSIG	1500 PSIG	2000 PSIG	2500 PSIG	3000 PSIG	3600 PSIG
All FFC-112 Models	6	99.97%	12	28	55	81	108	161	214	267	321	384
	10	95%	18	42	82	122	162	242	321	401	481	576

How to Order:

FFC-112	—	L	—	SAE	—	6	Examples: FFC-112L-SAE-6, FFC-112-6, FFC-112L-6
Series Name		Bowl		Port		Media Grade	
FFC-112		Omit for Standard L (Long) E (Extended)		Omit for 1/4" NPT SAE = SAE-6		6 10	

Replacement Element Kits:

Filter Housing Model	Media Grade 6	Media Grade 10
All FFC-112 Models	CLS112-6K	CLS112-10K

Replacement Element kits include element, head-to-bowl o-ring, and lubricant.

Mounting Bracket Kit: MB-2S

Kit includes bracket and 2 cap screws.

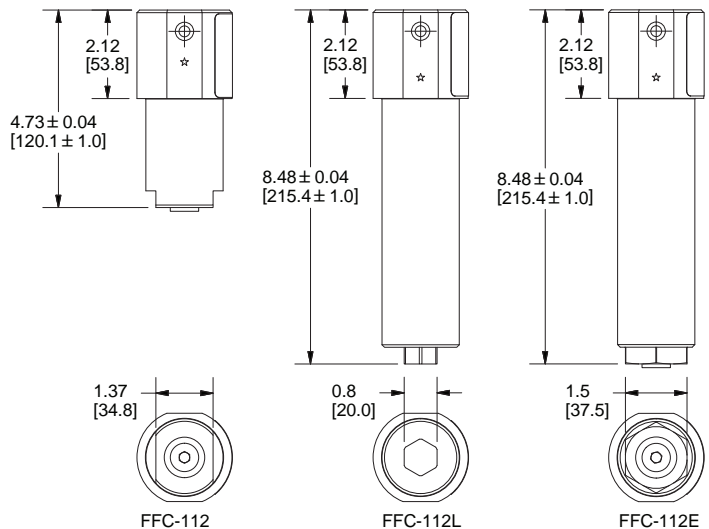
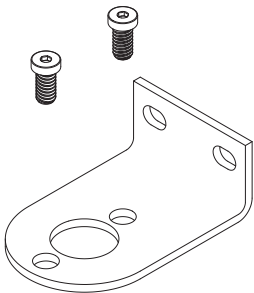

Certification:

ECE-R110 for FFC-112 and FFC-112L

FFC-113 Series Filters

3600 PSIG Pressure Filters

The FFC-113 is a popular filter choice onboard alternative fuel vehicles. Tiny solid and liquid contaminants can foul critical engine components, diminishing engine performance. These contaminants are typically generated during the compression, storage, and dispensing of alternative fuel gases like CNG. The FFC-113 removes sub-micronic contaminants with removal efficiencies from 95% (grade 10) to 99.97% (grade 6) ensuring long service intervals for components like fuel injectors and regulators. Its robust 303 stainless steel construction and 3600 PSIG design pressure and relatively light weight combine to provide a unit that will withstand the harsh operating environments found on heavy duty vehicles like buses and trucks. It is supplied with 1/2" NPT or SAE connections and is designed for flows exceeding 1550 SCFM at 3600 PSIG. Each housing is also fitted with a stainless steel SAE-6 ported drain plug.



Specifications:

Model Number	Port Size	Max. Pressure	Max. Temp.	Materials of Construction			Seals	Sump Capacity	Weight	Dimensions	
				Head	Internals	Bowl				Length	Width
FFC-113	1/2" NPT	3600 PSIG (248 bar)	221°F (105°C)	303 Stainless Steel	303 Stainless Steel	303 Stainless Steel	Fluoro- carbon	5.0 oz (147.9 ml)	5.5 lbs (2.5 kg)	8.06" (204.7 mm)	2.97" (75.44 mm)
FFC-113-SAE	SAE-8										

Flow Rates in Natural Gas (SCFM):

Filter Housing Model	Media Grade	Coalescing Efficiency	100 PSIG	250 PSIG	500 PSIG	750 PSIG	1000 PSIG	1500 PSIG	2000 PSIG	2500 PSIG	3000 PSIG	3600 PSIG
All FFC-213 Models	6	99.97%	37	84	164	244	324	483	643	802	962	1153
	10	95%	51	141	274	407	539	805	1071	1337	1603	1922

How to Order:

FFC-113	—	SAE	—	10
Series Name		Port		Media Grade
FFC-113		Omit for 1/2"NPT SAE = SAE-8		6 10

Examples: FFC-113-6, FFC-113-SAE-10

Replacement Element Kits:

Filter Housing Model	Media Grade 6	Media Grade 10
All FFC-113 Models	DLS113-6K	DLS113-10K

Replacement Element kits include element, head-to-bowl o-ring, and lubricant.

Mounting Bracket Kit: 2222FFC

Kit includes bracket and 2 cap screws.

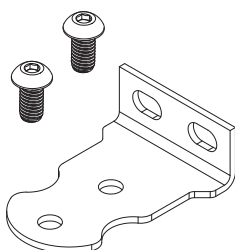

Certification:

ECE-R110

FFC-213 Series Filters

3600 PSIG Pressure Filters

Heavy duty vehicles, such as buses and long haul trucks, can now rely on the new lightweight aluminum FFC-213 filters. They protect critical engine components from contaminants present in alternative fuel gas systems.

The new FFC-213 is another popular filter choice for onboard alternative fuel vehicles. Tiny solid and liquid contaminants can foul critical engine components, diminishing engine performance. These contaminants are typically generated during the compression, storage, and dispensing of alternative fuel gases like CNG. The FFC-213 removes sub-micronic contaminants with removal efficiencies from 95% (grade 10) to 99.97% (Grade 6) ensuring long service intervals for components like fuel injectors and regulators. Its lightweight aluminum construction and 3600 PSIG design pressure combine to provide a filter option that will withstand the harsh operating environments found on heavy duty vehicles like trucks and buses. It is supplied with either 1/2" NPT or SAE connections and is designed for flows exceeding 1550 SCFM at 3600 PSIG. Each housing is also fitted with a stainless steel SAE-6 drain plug.



Features and Benefits:

- Anodized aluminum construction can withstand harsh operating environments
- Two different coalescing efficiencies available, 95% (Grade 10) and 99.97% (Grade 6)
- Large sump capacity
- Lightweight
- 1/2" NPT and SAE port sizes
- Mounting bracket kit available
- Protects critical engine components such as fuel injectors and regulators

Specifications:

Model Number	Port Size	Max. Pressure	Max. Temp.	Materials of Construction			Seals	Sump Capacity	Weight	Dimensions	
				Head	Internals	Bowl				Length	Width
FFC-213	1/2" NPT	3600 PSIG (248 bar)	221°F (105°C)	Aluminum	Stainless Steel	Aluminum	Fluoro-carbon	5.0 oz (148 ml)	3.5 lbs (1.6 kg)	8.43" (214 mm)	3.25" (82.55 mm)
FFC-213-SAE	SAE-8										

Flow Rates in Natural Gas (SCFM):

Filter Housing Model	Media Grade	Coalescing Efficiency	100 PSIG	250 PSIG	500 PSIG	750 PSIG	1000 PSIG	1500 PSIG	2000 PSIG	2500 PSIG	3000 PSIG	3600 PSIG
All FFC-213 Models	6	99.97%	37	84	164	244	324	483	643	802	962	1153
	10	95%	51	141	274	407	539	805	1071	1337	1603	1922

How to Order:

FFC-213	—	SAE	—	10
Series Name		Port		Media Grade
FFC-213		Omit for 1/2" NPT SAE = SAE-8		6 10

Examples: FFC-213-6, FFC-213-SAE-10

Replacement Element Kits:

Filter Housing Model	Media Grade 6	Media Grade 10
All FFC-213 Models	DLS113-6K	DLS113-10K

Replacement Element kits include element, head-to-bowl o-ring, and lubricant.

Mounting Bracket Kit: 2222FFC

Kit includes bracket and 2 cap screws.

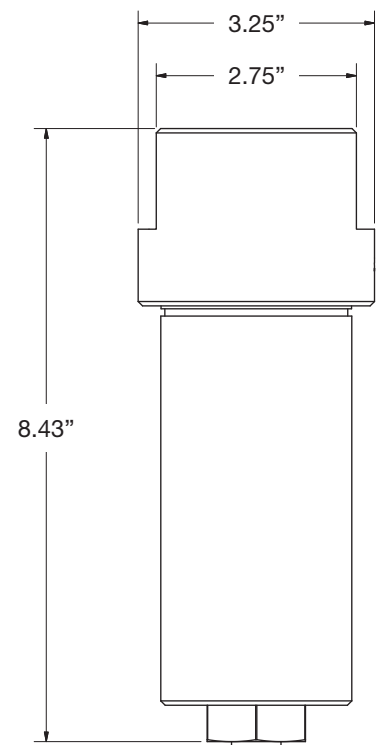
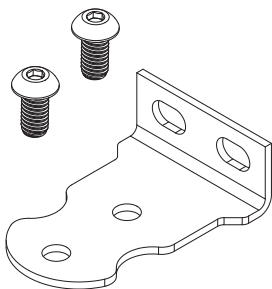

J-Series Filters

5000 PSIG Pressure Filters

Why do high pressure systems need filtration?

High pressure compressors are used in a variety of applications. Many owners, operators and designers of high pressure compressed air or gas systems rely on Parker's Finite Filter Operation for high efficiency filters. End users of high pressure compressed air, such as scuba divers and fire rescue workers, depend on high quality breathable air.

Throughout the stages of compression many contaminants can enter into the system. Excessive amounts of liquid aerosols, primarily lubricant oil carryover and solid particulate contamination are common in high pressure systems. In addition, higher temperature levels are possible and may cause liquid oils to varnish. This contamination can lead to poor component performance and wear that may lead to unscheduled maintenance. Even submicronic contaminants in compressed air or gas systems can foul multistage compressors, increasing maintenance costs and impacting product quality.

Parker's Finite Filter Operation offers a variety of high pressure compressed air and gas filters. With our wide range of elements, we have a solution for every stage of compression, as well as at the point of use. Whether you are storing high pressure air or gas or using a continuous flow, count on Parker to protect your equipment from contamination. Parker Finite is the solution to ending high pressure contamination fouling.

Parker's Finite Filter Operation's J-Series Filters are designed to filter contaminants such as rust, pipe scale, compressor lubricant oil, and water from compressed gases. These filters are often used in high pressure compressed natural gas (CNG) systems, not only as inter-stage filters in the multi-stage compression of the gas, but also in the storage and delivery of the gas for CNG powered vehicles.



Compressed Natural Gas Dispensing

Parker's varied media choices remove up to 99.995% of both solid and liquid aerosols, and contaminants as small as 0.01 microns in size. An activated carbon media is also available which removes oil vapor. This stage of filtration is often used as the final filter before the storage of high pressure breathing air used by scuba divers, firefighters, and others who utilize portable breathing devices.

The filter housings and the replaceable elements used in this product line have an extremely robust construction, specially designed for use in system pressures up to 5,000 psig. Five housing sizes and two thread styles (NPT or SAE) are available with connections ranging from 1/4" to 2"; temperatures up to 350°F, and flows up to 26,000 SCFM at 5,000 PSIG.

High Pressure Breathing Air



J-Series filters are used in a number of applications, ranging from breathing air for scuba divers, to high-pressure hydraulic circuit testing, to a variety of uses in the alternative fuel industry.



Urban CNG-Powered Vehicles

J-Series High Pressure Filters

- CNG, alternative fuel and breathing air filters
- Pressures to 5000 PSIG
- Coalescing, particulate and adsorption filter elements available
- Spheroidal Graphite Cast Iron

Filter Element Features

Parker Finite offers six filter media grades ensuring that we have the correct media choice for nearly any application requirement.

Available are coalescing grades with 95% to 99.995% efficiency and pleated or UNI-CAST coalescing media designs. Additionally, a bulk liquid separator, a particulate removal and oil vapor removal choices are standard offerings.

Each element uses a retention clip design that ensures the element is seated and sealed properly. This built-in, fail-safe feature will virtually eliminate any possibility of contaminant by-pass and is unique amongst high pressure filters.

Each element is composed of internal and external plated carbon steel retainers which provide the element with a 75+ PSID burst rating. Each element also features a bore seal interface with the housing, an anti-vibration shoulder, and an integrated standoff which minimizes the likelihood of any movement of the element, even during severe system pulsations.

Element standoff lengths were designed for each housing size to allow an optimal volume of liquid contaminant to be collected in the filter's quiet zone, further minimizing any chance of contaminant carryover.

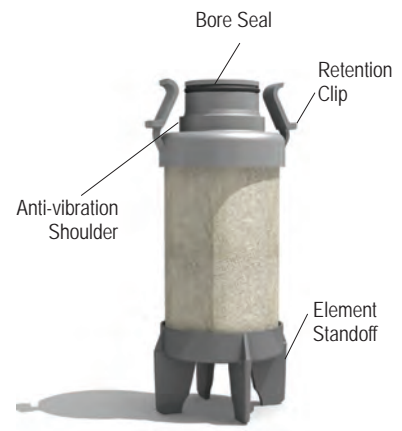





Filter Housing Features

- Robust, spheroidal graphite-cast iron offers higher mechanical strength, improved ductility, and increased shock resistance, assuring the user that this filter is built for the task at hand.
- Head to bowl bore seal ensures greater seal integrity.
- Threaded mounting holes on top of filter head allow each size to be easily panel mounted when line mounting is not an option.
- Engraved flow direction arrow in filter's head notifies the user of proper flow direction. One direction flow for all media choices reduces the possibility of a housing being installed improperly.
- The spheroidal graphite cast iron head and steel bowl are nickel plated for corrosion resistance. The completed assembly is finished with a UV stable epoxy powder paint that will allow the filter to stand-up to harsh outdoor conditions.
- An imprinted aluminum part number tag ensures that each unit's identifying information will be visible in the years ahead.
- SAE-6 steel drain plug with positive o-ring seal installed. This port also allows the easy installation of Finite's JDK5000H or JDK5000V high pressure drain kits which allow the safe removal of liquid contamination at system pressures.
- Bowls are designed to be easily tightened or loosened with a standard socket wrench.
- Bowls feature a slotted positional locator which enables the element to be positively retained, therefore having a low bowl removal clearance.

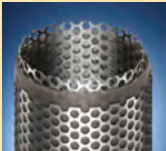

Element Types and Media Grade Options

Coalescers: Removes: Oil, water, liquids	Water Separators: Removes: Bulk liquids	Adsorber: Removes: Oil vapor (odor)	Particulate: Removes: Solid contaminants
<p>Coalescing elements are specially designed for the removal of liquid contaminants from gaseous flows. These media types flow from the inside of the element to the outside. Coalesced liquid collects in the bowl where it is drained, while clean air or gas exits the housing through the outlet port. Particulate contaminants are captured and held in the media.</p> <div style="display: flex; justify-content: space-around;"> <div style="text-align: center;">  <p>Type C</p> <p>The Finite UNI-CAST coalescing elements are made of epoxy saturated borosilicate glass microfiber and includes a polyester drain layer. (1)(2)</p> </div> <div style="text-align: center;">  <p>Type 7CP</p> <p>This pleated coalescer is made of fluorocarbon saturated borosilicate glass microfiber and includes a polyester drain layer. (1)(2)</p> </div> </div>	<p>In this element, the gas or liquid flows from the inside of the element to the outside.</p> <div style="text-align: center;">  <p>Type WS</p> <p>The Finite water separator element is composed of wrapped stainless steel mesh. (1)(2)</p> </div>	<p>Adsorption elements are used to remove vapors (hydrocarbon) that are not removed by the coalescing filter. Hydrocarbon vapors collect in the element, while clean air exits the housing through the outlet port. In this element, the air or gas flows from the inside of the element to the outside.</p> <div style="text-align: center;">  <p>Type A</p> <p>Our Type A media is wrapped activated carbon. This element has a galvanized carbon steel inner retainer and a stainless steel perforated metal outer retaining layer. (2)</p> </div>	<p>Particulate filters in the J-Series flow from the inside of the element to the outside. Particles collect in the element, while the clean air exits through the outlet port.</p> <div style="text-align: center;">  <p>Type 3P</p> <p>This 3 micron absolute rated pleated element is made of cellulose. (1)(2)</p> </div>

Notes:

- 1 Each element is retained internally and externally with galvanized carbon steel perforated metal. Not shown in some photos above.
- 2 Top and bottom end caps are made of glass filled nylon to ensure durability.

Media Grades and Specifications:

Finite media grades determine the filtration m. Capture efficiencies are available up to 99.995%. Micron ratings range from 0.01 to 3 micron. The columns on the right note both the wet and dry pressure drops.

Grade Designation	Media Type	Removes...	Coalescing Efficiency	Max. Oil Carryover ppm ¹	Micron Rating (µm)	Pressure Drop Media Dry (PSID)	Additional Pressure Drop Media Wet ² (PSID)
4C	Coalescing	Liquid from Gas	99.995%	0.003	0.01	1.25	3-4
7CP	Coalescing	Liquid from Gas	99.5%	0.09	0.5	0.25	0.5-0.7
10C	Coalescing	Liquid from Gas	95%	0.85	1.0	0.5	0.5
WS	Bulk Separator	Bulk Liquid from Gas	99+ ³	N.A.	100	<0.25	<0.25
3P	Particulate	Solids from Gas	N.A.	N.A.	3.0	0.25	N.A.
A	Adsorber	Vapor from Gas	99+ ⁴	N.A.	3.0	1.0	N.A.

¹Tested per ISO 12500-1 at 40 ppm inlet.

²Add dry + wet columns for total pressure drop.

³Bulk liquid removal efficiency..

⁴Oil vapor removal efficiency is given for A media.

High Pressure (HP) Filter Applications:

Application:	Media Grade and Type:
Test Air for HP Hydraulics	10C / 7CP
Inter-stage HP Compressor	WS / 10C
CNG Compressor Outlet	10C → 4C
CNG Storage Cascades	10C → 4C
CNG Dispensers	10C → 4C
Breathing Air / SCUBA	10C → 4C → A
High Pressure "Ultra Pure Air"	10C → 4C → 4C → A
Bulk Liquid contamination	WS → 7CP → 4C
Bulk Solid Contamination	3P → 7CP → 4C
HP Air / Gas Dryer Protection	10C / 7CP → 4C → Dryer → 7CP / 3P
Food Applications / Odor Removal	10C / 7CP → 4C → A



Flow Rates (SCFM):

Choose Filter Size to find the corresponding flow rates.

Model	Port	Filter Type	100 PSIG	1000 PSIG	1500 PSIG	2000 PSIG	2500 PSIG	3000 PSIG	3500 PSIG	4000 PSIG	4500 PSIG	5000 PSIG
J_1A	1/4" or SAE-4	4C, A	15	135	200	265	330	395	460	525	590	655
		7CP, 10C, 3P, WS	30	265	395	525	660	790	920	1050	1180	1310
J_2A	1/2" or SAE-8	4C, A	25	220	330	440	550	655	765	875	985	1095
		7CP, 10C, 3P, WS	50	440	660	880	1095	1315	1530	1750	1970	2185
J_2B	1/2" or SAE-8	4C, A	35	310	460	615	765	920	1070	1225	1380	1530
		7CP, 10C, 3P, WS	80	710	1055	1405	1755	2105	2450	2800	3150	3500
J_3B	3/4" or SAE-12	4C, A	60	530	790	1055	1315	1575	1840	2100	2360	2525
		7CP, 10C, 3P, WS	130	1150	1715	2285	2850	3415	3985	4550	5115	5685
J_4C	1" or SAE-16	4C, A	90	795	1190	1580	1975	2365	2760	3150	3540	3935
		7CP, 10C, 3P, WS	200	1770	2640	3515	4385	5255	6130	7000	7870	8745
J_6D	1-1/2" or SAE-24	4C, A	180	1590	2375	3160	3945	4730	5515	6300	7085	7870
		7CP, 10C, 3P, WS	400	3540	5280	7025	8770	10515	12255	14000	15745	17490
J_8E	2" or SAE-32	4C, A	275	2435	3630	4830	6030	7230	8425	9625	10825	12025
		7CP, 10C, 3P, WS	600	5310	7925	10540	13155	15770	18385	21000	23615	26230

Note: These rates are based on compressed air flow. For CNG, these flows can be multiplied by a factor of 1.2.

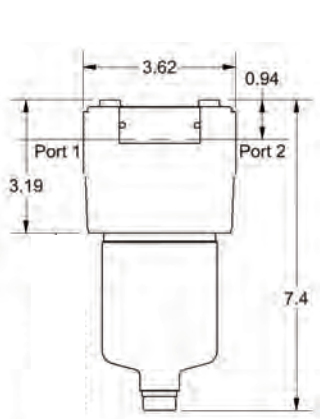

J_A Series

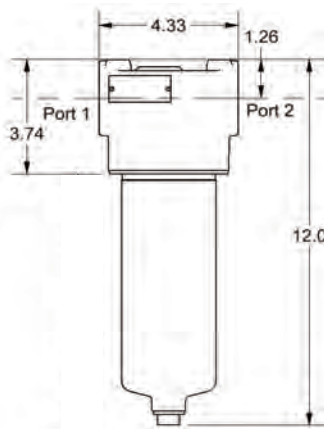

J_B Series

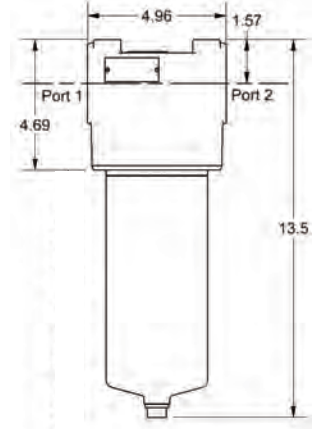

J_C Series

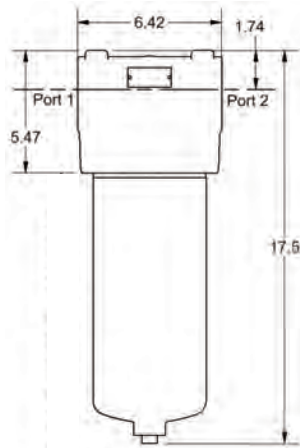

J_D Series

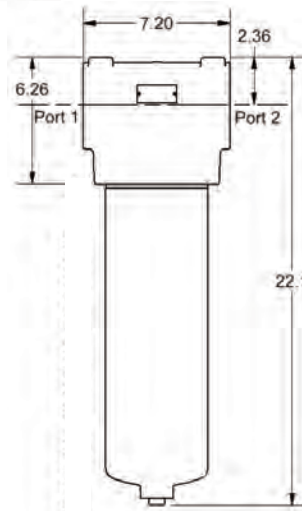

J_E Series

Specifications:

Model	J_1A	J_2A	J_2B	J_3B	J_4C	J_6D	J_8E
Port Size (N=NPT)	1/4" NPT	1/2" NPT	1/2" NPT	3/4" NPT	1" NPT	1-1/2" NPT	2" NPT
Port Size (S=SAE)	SAE-4	SAE-8	SAE-8	SAE-12	SAE-16	SAE-24	SAE-32
Max. Pressure	5000 PSIG	5000 PSIG	5000 PSIG	5000 PSIG	5000 PSIG	5000 PSIG	5000 PSIG
Max. Temperature ¹	350°F	350°F	350°F	350°F	350°F	350°F	350°F
Head	SG Iron*	SG Iron*	SG Iron*	SG Iron*	SG Iron*	SG Iron*	SG Iron*
Bowl	Steel	Steel	Steel	Steel	Steel	Steel	Steel
Seals	Fluorocarbon	Fluorocarbon	Fluorocarbon	Fluorocarbon	Fluorocarbon	Fluorocarbon	Fluorocarbon
Backing Ring	Nitrile	Nitrile	Nitrile	Nitrile	Nitrile	Nitrile	Nitrile
Sump Volume	50 mL	50 mL	180 mL	180 mL	230 mL	500 mL	500 mL
Weight	9.0 lbs	9.0 lbs	13.0 lbs	13.0 lbs	21.0 lbs	45.0 lbs	67.0 lbs
Port to Port	3.62"	3.62"	4.33"	4.33"	4.96"	6.42"	7.2"
Height	7.4"	7.4"	12.0"	12.0"	13.5"	17.5"	22.1"
Clearance	2.0"	2.0"	2.25"	2.25"	2.25"	3.0"	3.0"
Drain Port	SAE-6	SAE-6	SAE-6	SAE-6	SAE-6	SAE-6	SAE-6
Socket / Bowl Removal	1-1/16" HEX	1-1/16" HEX	1-1/16" HEX	1-1/16" HEX	1-1/16" HEX	1-1/2" HEX	1-1/2" HEX
Head / Bowl Torque	15-20 ft-lbs	15-20 ft-lbs	25-30 ft-lbs	25-30 ft-lbs	25-30 ft-lbs	60-70 ft-lbs	60-70 ft-lbs

Note: SG Iron is an abbreviation for Spheroidal Graphite Cast Iron.

High Pressure Drains and Gauge:

Model Number	Description
JDK5000H	Horizontal Drain Kit 5000 psig
JDK5000V	Vertical Drain Kit 5000 psig
BDPI-25	Differential Pressure Gauge and Bracket



How to Order:

Use the steps below to build your own part number. For any permutation not mentioned below, please consult factory at 1-800-343-4048.

J	N	2	A	—	4C	N
Series Name	Port	Port Size	Housing Size		Media Grade	Accessories
J	N – NPT	1 (1/4")	A	—	4C	N = None Available
		2 (1/2")	A		10C	
		2 (1/2")	B		7CP	
		3 (3/4")	B		WS	
		4 (1")	C		3P	
		6 (1-1/2")	D		A	
		8 (2")	E			
		S – SAE	1 (SAE-4)		A	
			2 (SAE-8)		A	
	2 (SAE-8)		B			
	3 (SAE-12)		B			
	4 (SAE-16)		C			
	8 (SAE-32)		E			



Examples: JN2A-4CN, JS6D-WSN, JN3B-3PN

Replacement Element Part Numbers:

4C	J	A	K
Media Grade	Series Name	Housing Size	Port
4C	J	A	K
10C		B	
7CP		C	
WS		D	
3P		E	
A			

Examples: 4CJAK, WSJDK, 3PJBK

Note: Replacement element supplied with replacement head/ bowl seals and lubricant.

S5R & S1R Filters

5000 PSIG Pressure Filters

Measuring only four inches in height, these filters are ideal for bypass gas sampling applications. The drain port (plugged) connection size matches the inlet/outlet connection size. The corrosion resistant materials used for this model lend themselves to extreme operating environments.

*specify part number S5R for 1/8" NPT connections or S1R for 1/4" NPT connections.



Specifications:

Model Number	Port Size NPT	Max. Pressure	Max.Temp.	Materials of Construction			Seals	Sump Capacity	Weight	Dimensions	
				Head	Internals	Bowl				Length	Width
S5R, S1R	1/8", 1/4"	5000 PSIG (345 bar)	400°F (T) 350°F (G, C) 275°F (F)	316 Stainless Steel	316 Stainless Steel	316 Stainless Steel	Fluorocarbon	0.25 oz (7.4 ml)	1.16 lbs (0.53 kg)	4.0" (101.6 mm)	1.75" (50.8 mm)

Flow Rates (SCFM):

Model	Media Grade	100 PSIG	1000 PSIG	1500 PSIG	2000 PSIG	2500 PSIG	3000 PSIG	3500 PSIG	4000 PSIG	4500 PSIG	5000 PSIG
S5R, S1R	4	6.4	56	85	112	140	168	196	224	252	280
	6	8.4	74	111	148	184	221	257	294	331	368
	8	9.2	82	121	162	202	242	282	322	362	402
	10	10	90	132	176	219	263	306	350	394	438

How to Order:

S	1	R	—	6	C	04-023
Series Name	Port Size NPT			Media Grade	Media Type	Element Size
S	5 (1/8") 1 (1/4")	R		4 6 8 10	G T F H C	04-023

Example: S1R-6T04-023

Mounting bracket available: MBS-1

How to Order Replacement Elements:

Elements available:

- _G04-023 X 10
- _T04-023 X 10
- _F04-023 X 10
- _H04-023 X 10
- _C04-023 X 10

_ insert grade: 4, 6, 8, 10

For more information on element selection, please see 60-61. Elements are sold in Box quantities of 10.

S1IL Filter

5000 PSIG Pressure Filter

Finite's S1IL particulate filter is typically applied in bottled gas applications or for sample preparation on gas analyzing equipment. It does not have a drain port and should only be used when little or no liquid contamination is expected. Though small in size, the S1IL is perfect for applications with elevated pressures or corrosive atmospheres and offers the availability of a high temperature element. Three high efficiency particulate elements are available for temperatures rated up to 400°F.



Specifications:

Model	Port Size NPT	Max. Pressure	Max. Temp. for Each Element Type	Materials of Construction			Seals	Sump Capacity	Weight	Dimensions	
				Head	Internals	Bowl				Length	Width
S1IL	1/4"	5000 PSIG (345 bar)	400°F (T) 350°F (G) 275°F (F)	316 Stainless Steel	316 Stainless Steel	316 Stainless Steel	Fluorocarbon	N/A	0.75 lbs (0.34 kg)	3.10" (78.74 mm)	1.25" (31.75 mm)

Flow Rates (SCFM):

Model	Media Grade	100 PSIG	1000 PSIG	1500 PSIG	2000 PSIG	2500 PSIG	3000 PSIG	3500 PSIG	4000 PSIG	4500 PSIG	5000 PSIG
S1IL	4	3.6	32	48	63	79	95	110	126	142	158
	6	4.7	42	62	83	103	124	144	165	185	206
	8	5.2	46	69	91	114	137	159	182	205	228
	10	5.7	51	75	100	125	150	175	200	224	249

How to Order:

S1IL Series Name	6 Media Grade	C Media Type	04-013 Element Size
S1IL	4 6 8 10	T G F	04-013

Example: S1IL-8G04-013

How to Order Replacement Elements:

Elements available: _ insert grade: 4, 6, 8, 10
 _T04-013 X 10
 _G04-013 X 10
 _F04-013 X 10

For more information on element selection, please see pages 60-61. Elements are sold in Box quantities of 10.

FFC-116 Series Filter

5000 PSIG Pressure Filter

This stainless steel filter is commonly used to filter oil, water, and particulate from lower flow CNG systems and onboard CNG vehicles. CNG powered commuter vehicles, rely on FFC-116 filters to protect against harmful contaminants that can foul fuel injector systems. Both solid and liquid contaminants can enter the system from various sources. Its small size allows for installation versatility and ease of servicing. The 316 stainless steel construction resists corrosion. Its 5000 PSIG design enables it to be used on the high pressure side of a CNG system, protecting both the regulator and the fuel injectors. The sump capacity is 0.25 oz (7.4 cc) for fluid contaminants, which can be drained through a plugged 1/4" NPT drain port.



Specifications:

Model	Port Size NPT	Max. Pressure	Max. Temp.	Materials of Construction			Seals	Sump Capacity	Weight	Dimensions	
				Head	Internals	Bowl				Length	Width
FFC-116	1/4"	5000 PSIG (345 bar)	350°F (177°C)	316 Stainless Steel	316 Stainless Steel	316 Stainless Steel	Fluorocarbon	0.25 oz (7.4 ml)	1.16 lbs (0.53 kg)	4.0" (101.6 mm)	1.75" (44.5 mm)

Flow Rates (SCFM):

Model	Media Grade	100 PSIG	1000 PSIG	1500 PSIG	2000 PSIG	2500 PSIG	3000 PSIG	3500 PSIG	4000 PSIG	4500 PSIG	5000 PSIG
FFC-116	6	8.4	74	111	148	184	221	257	294	331	368
	10	10	90	132	176	219	263	306	350	394	438

How to Order:

FFC-116	—	6
Series Name		Media Grade
FFC-116		6 10

Example: FFC-116-6

Replacement Elements:

Model	Media Grade 6	Media Grade 10
All FFC-116 models	CLS116-6 x 10	CLS116-10 x 10

Mounting Bracket Kit: MBS-1

Kit includes bracket and 2 cap screws.

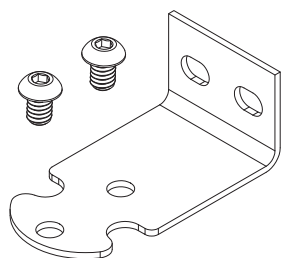

SJ-Series Filters

6000 PSIG Pressure Filter

This robust, stainless steel filter is rated for working pressures up to 6000 PSIG, which makes this the filter of choice for extremely demanding applications. The SJ-series comes in a variety of port sizes and types, reducing the need for extra piping or the use of adapters in your application. The 1/4" drain port allows the user to drain all oil from the assembly prior to servicing, eliminating possible cross contamination and leaving a cleaner environment. Use this filter for your offshore applications, water fogging, caustic washdowns (food processing) or on high pressure test stands. A wide variety of filter element media grades and styles means that your application needs will be efficiently met.



Specifications:

Model	Port Size (NPT or SAE)	Max. Pressure	Max. Temp. for each Element Type	Materials of Construction			Seals	Sump Capacity	Weight	Dimensions	
				Head	Internals	Bowl				Length	Width
SJN*S, SJS*S	1/2" thru 1"	6000 PSIG (414 bar)	175°F (Grade A) 350°F (All other grades)	316L Stainless Steel	316L Stainless Steel	316L Stainless Steel	Fluorocarbon	2.1 oz (61 ml)	14 lbs (6.4 kg)	8.26" (210 mm)	4.00" (102 mm)
SJN*L, SJS*L	1/2" thru 1"	6000 PSIG (414 bar)	175°F (Grade A) 350°F (All other grades)	316L Stainless Steel	316L Stainless Steel	316L Stainless Steel	Fluorocarbon	7.8 oz (230 ml)	18 lbs (8.2 kg)	11.97" (304 mm)	4.00" (102 mm)
SJN*H, SJS*H	1/2" thru 1"	6000 PSIG (414 bar)	175°F (Grade A) 350°F (All other grades)	316L Stainless Steel	316L Stainless Steel	316L Stainless Steel	Fluorocarbon	2.1 oz (61 ml)	17 lbs (7.7 kg)	11.97" (304 mm)	4.00" (102 mm)

*insert port size: 2 =1/2", 3=3/4" and 4=1"

How to Order:

SJ	N	2	S	—			4C	WC	N
Series Name	Port Type	Port Size	Bowl	Media Grade	Element Construction	Accessories			
SJ	N (NPT)	2 (1/2") 3 (3/4") 4 (1")	S (Standard) L (Long bowl, short element, extra sump) H (High Flow: Long bowl, long element)	4C 10C 3P A	WC (metal retainers, bonded on end caps with positive o-ring seal.)	N (No Accessories)			

Examples: SJN2S-4CWCN, SJS3L-3PWCN

How to Order Replacement Elements:

Housings are sold with one element. Build your own replacement element with the chart below.

Housing	Element Grade and Type	Element Size
SJN*S, SJS*S, SJN*L, SJS*L	4CWC, 10CWC, 3PWC, AWC, 100WS	11-036
SJN*H, SJS*H	4CWC, 10CWC, 3PWC, AWC, 100WS	11-072

Note: Replacement element supplied with o-ring and lubricant.

1. Determine the housing you have by choosing from the "Housing" column on the chart. *Insert port size. See How to Order above for more info on port sizes.
2. Determine the "Element Grade and Type" you need. See pages 60-61 for more detail on grade selection.
3. Determine the corresponding element size by choosing from the "Element Size" column on the chart.
4. Combine "Element Grade and Type", "Element Size" and then add Box quantity to the end. Box quantities are all X 4, except 100WS which is X 1. Example: 4CWC11-036 X 4 or 100WS11-072 X 1.

Flow Rates (SCFM):

Filter Housing Model	Media Grade	100 PSIG	250 PSIG	500 PSIG	750 PSIG	1000 PSIG	1500 PSIG	2000 PSIG	2500 PSIG	3000 PSIG	3500 PSIG	4500 PSIG	5000 PSIG	5500 PSIG	6000 PSIG
SJN_S	4C	25	58	112	167	221	330	439	548	657	766	984	1093	1202	1311
	10C	55	127	247	367	487	726	966	1206	1446	1685	2165	2405	2644	2884
	3P	55	127	247	367	487	726	966	1206	1446	1685	2165	2405	2644	2884
	A	33	76	148	220	292	436	580	723	867	1011	1299	1443	1587	1731
	100	55	127	247	367	487	726	966	1206	1446	1685	2165	2405	2644	2884
SJS_S	4C	25	58	112	167	221	330	439	548	657	766	984	1093	1202	1311
	10C	55	127	247	367	487	726	966	1206	1446	1685	2165	2405	2644	2884
	3P	55	127	247	367	487	726	966	1206	1446	1685	2165	2405	2644	2884
	A	33	76	148	220	292	436	580	723	867	1011	1299	1443	1587	1731
	100	55	127	247	367	487	726	966	1206	1446	1685	2165	2405	2644	2884
SJN_L	4C	25	58	112	167	221	330	439	548	657	766	984	1093	1202	1311
	10C	55	127	247	367	487	726	966	1206	1446	1685	2165	2405	2644	2884
	3P	55	127	247	367	487	726	966	1206	1446	1685	2165	2405	2644	2884
	A	33	76	148	220	292	436	580	723	867	1011	1299	1443	1587	1731
	100	55	127	247	367	487	726	966	1206	1446	1685	2165	2405	2644	2884
SJS_L	4C	25	58	112	167	221	330	439	548	657	766	984	1093	1202	1311
	10C	55	127	247	367	487	726	966	1206	1446	1685	2165	2405	2644	2884
	3P	55	127	247	367	487	726	966	1206	1446	1685	2165	2405	2644	2884
	A	33	76	148	220	292	436	580	723	867	1011	1299	1443	1587	1731
	100	55	127	247	367	487	726	966	1206	1446	1685	2165	2405	2644	2884
SJN_H	4C	62	143	278	413	548	819	1089	1359	1630	1900	2440	2711	2981	3252
	10C	136	314	610	907	1203	1796	2389	2982	3575	4167	5353	5946	6539	7133
	3P	136	314	610	907	1203	1796	2389	2982	3575	4167	5353	5946	6539	7133
	A	82	189	368	547	725	1083	1440	1798	2155	2513	3228	3585	3943	4301
	100	136	314	610	907	1203	1796	2389	2982	3575	4167	5353	5946	6539	7133
SJS_H	4C	62	143	278	413	548	819	1089	1359	1630	1900	2440	2711	2981	3252
	10C	136	314	610	907	1203	1796	2389	2982	3575	4167	5353	5946	6539	7133
	3P	136	314	610	907	1203	1796	2389	2982	3575	4167	5353	5946	6539	7133
	A	82	189	368	547	725	1083	1440	1798	2155	2513	3228	3585	3943	4301
	100	136	314	610	907	1203	1796	2389	2982	3575	4167	5353	5946	6539	7133

Note: _insert port type. See How to Order on page 86 for more information.

High Pressure Drains and Gauge:

Model Number	Description
JDK5000H	Horizontal Drain Kit 5000 psig
JDK5000V	Vertical Drain Kit 5000 psig
BDPI-25	Differential Pressure Gauge and Bracket



LPGR-200 Replaceable Liquid Propane Filters

800 PSIG Pressure Filters

The new LPGR-200 Series Replaceable Filter Element Housing can be used on-board propane-powered vehicles including: shuttle buses, delivery trucks, and vans as well as lift trucks and turf maintenance vehicles.

This new filter series offers a replaceable filter element. This means that the housing itself no longer needs to be discarded. Simply, remove the bowl, replace the element and O-ring, and secure the head and bowl back together.

This unique housing is designed to prevent contaminants that have settled in liquid propane tanks and fuel lines from reaching critical engine components. The LPGR-200 contains a high efficient pleated element that is offered in either a 1-micron or 5-micron rating. The pleated element construction guarantees a long filter life and the pleated media is backed on both sides by a rugged epoxy coated steel screen for high strength during peak flow rate conditions. The black anodized lightweight aluminum housing is designed for long term corrosion protection. The SAE-8 port connections allow for leak-free, quick, and easy installation.



Features and Benefits:

- On-board liquid propane filter
- 1 micron & 5 micron rated elements available
- 800 psig/ 55 barg maximum operating pressure
- 250°F/ 121°C maximum operating temperature
- Compact lightweight aluminum housing
- Black anodized for long term corrosion resistance
- Replaceable element
- SAE-8 port connections
- Pleated element construction — ensures longer filter life

Specifications:

Model	Port Size	Max. Pressure	Max. Temp.	Materials of Construction			Weight	Dimensions	
				Head	Bowl	Seals		Length	Width
LPGR-200-01	SAE-8	800 PSIG (55 barg)	250°F (121°C)	Anodized Aluminum	Fluorocarbon	1.5 lbs (0.7 kg)	4.80" (122.0 mm)	3.06" (77.8 mm)	
LPGR-200-05									

Flow Rates (GPM):

Filter Housing Model Number	Coalescing Efficiency	Flow Rate
LPGR-200-01	1 micron	1.0 GPM / 0.6 PSID / 1.5 GPM / 1.0 PSID
LPGR-200-05	5 micron	4.0 GPM / 3.6 PSID / 10 GPM / 8.9 PSID

How to Order:

LPGR-200	—	05
Series Name		Element Micron
LPGR-200		01 (1 micron)
		05 (5 micron)

Examples: LPGR-200-01, LPGR-200-05

Replacement Element Kit Available:

Filter Housing Model Number	Element 1.0 Micron	Element 5.0 Micron
LPGR-200-01	LPG200-01K	—
LPGR-200-05	—	LPG200-05K

Includes: Element, head-to-bowl O-ring, and lubricant.



Mounting Bracket Kit:

Includes: Bracket and 2 screws

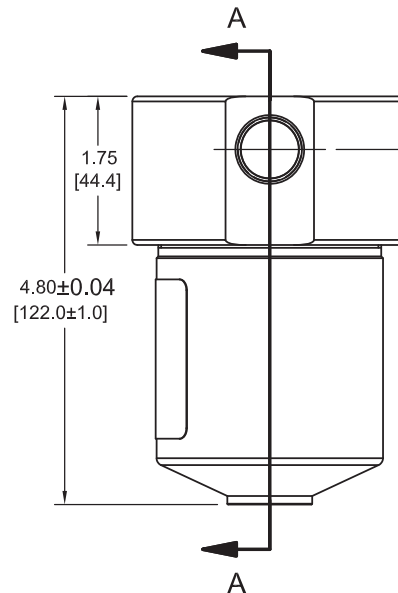
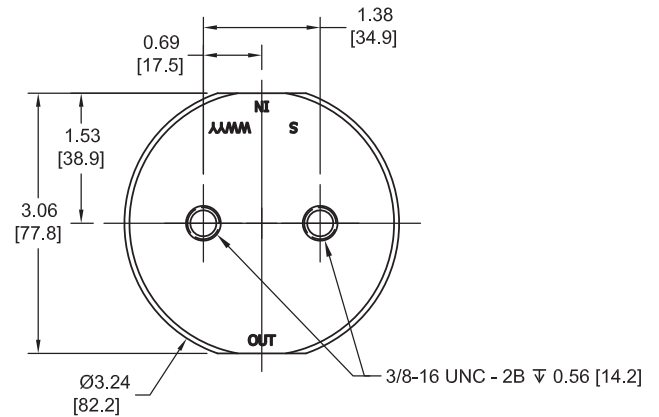
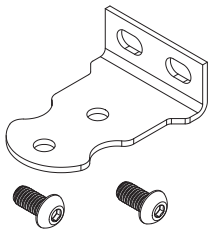

LPGD-200 Disposable Liquid Propane Filters

500 PSIG Pressure Filters

Parker Finite’s LPGD-200 Series is used onboard propane powered vehicles to prevent contaminants in the fuel tank from getting into the engine, protecting critical engine components like fuel injectors. The filter is rated for 500 psig. The LPGD-200 filter series removes submicronic contaminants rated to either 5 micron or 1 micron depending on the protection requirements. Its small size allows for versatile installation and easy servicing. Each housing is black powder painted for long-term corrosion protection. It is supplied with 1/2” SAE flare connections on both the inlet and outlet fittings making for easy installation.



Specifications:

Model Number	Port Size (NPT)	Max. Pressure	Max. Temp.	Materials of Construction		Seals	Sump Capacity	Weight	Dimensions	
				Body	Element				Length	Width
LPGD-200	1/2" SAE Flare	500 PSIG (34 bar)	250°F (79°C)	Painted Carbon Steel, Copper	Micro-glass pleated coalescer	Fluorocarbon	5.1 oz (150 ml)	1.4 lbs (0.64 kg)	6.53" (165.9 mm)	2.62" (66.5 mm)

How to Order:

LPGD-200	—	05
Series Name		Element Micron
LPGD-200		01 (1 micron)
		05 (5 micron)

Examples: LPGD-200-01, LPGD-200-05

Flow Rates (SCFM):

Filter Housing Model Number	Micron Rating	Rated Flow
LPGD-200-01	1	1.0 GPM / 0.6 PSID 1.5 GPM / 1.0 PSID
LPGD-200-05	5	4 GPM / 3.6 PSID 10 GPM / 8.9 PSID

LPGD-300 Series

Low Pressure, Disposable Dry Gas Filters

36 PSIG Pressure Filters

Parker Finite low pressure, disposable dry gas filters are designed to remove solid contaminants from your CNG or LPG fuel systems. These filters are located after the regulator, and are extremely important as they protect the injector seals from debris which can cause damage or destroy the engines. The filters are very compact in size, made from lightweight aluminum, available in both 5 micron and 1 micron ratings, and can be easily replaced when needed.

There are three different filter options available, one containing a pleated cellulose paper element, one with a pleated polyester filter paper, and another containing both the pleated polyester and pleated cellulose filter paper medias. These filter housings are intended to be used in the rickshaws, motorized bicycles, lawn mowers, forklifts, and any small low horsepower engine applications.



Features and Benefits:

- All aluminum construction
- Three different media combinations available
- Pleated cellulose & pleated polyester media types
- Compact in size
- Lightweight
- 1 micron & 5 micron rated elements
- Quick change-outs
- Used when space is limited
- Located after the regulator and before the fuel rail to filter in the gaseous state

Applications:

- Rickshaws
- Motorcycles
- Small engines, less than 2.0 liters
- Forklifts
- Lawn mowers
- Boat motors

Specifications:

Model Number	Filter Size	Tang Size	Max. Pressure	Max. Temp.	Materials of Construction		Weight	Dimensions	
					Body	Element		Length	Width
LPGD-3	3 = long	2 = 12 mm*	36 psig (250 kpa)	221°F (105°C)	Aluminum	C = Pleated cellulose filter paper	2.12 oz (60 g)	4.74 in (120.5 mm)	1.76 in (44.8 mm)
						P = Pleated polyester filter paper			
						CP = Pleated cellulose filter paper and pleated polyester filter paper			

*Note: 2 = 12 mm standard, consult factory for sizes 1 = 11mm, 4 = 14 mm & 6 = 16 mm.

Flow Rates (SCFM):

Media Type	Micron Rating	Rated Flow
C = Pleated cellulose	5 micron	25 L/s (53 cfm)
P = Pleated polyester	1 micron	5.3 L/s (11 cfm)
CP = Pleated cellulose and pleated polyester	1 micron	5.3 L/s (11 cfm)

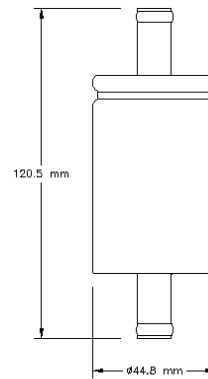

LPGD-332-C
LPGD-332-P

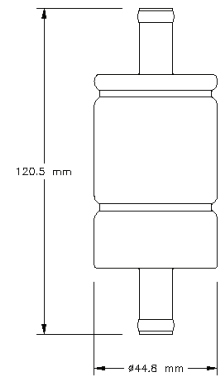

LPGD-332-CP

How to Order:

LPGD-3	3	2	—	CP
Series Name	Filter Size	Tang Size		Media Type
LPGD-3	3 = long	2 = 12mm*		C = Pleated cellulose filter
				P = Pleated polyester filter
				CP = Pleated cellulose filter paper and pleated polyester filter

*Note: 2 = 12 mm standard, consult factory for sizes 1 = 11mm, 4 = 14 mm & 6 = 16 mm.

Examples:

LPGD-332-CP (long body, 12 mm tangs, with a cellulose & poly element)

LPGD-332-P (double stage body, 12 mm tangs, with a poly filter element)

Certifications:

LPGD-332-C/P	LPG: E20 67R 010703 Class 2	LPGD-332-CP	LPG: E20 67R 010799 Class 2
	CNG: E20 110R 000025 Class 2		CNG: E20 110R 000042 Class 2

Spin-On Compressed Natural Gas Filter

PFF7695

100 PSIG Pressure Filter

Customer Value Proposition:

The Spin-on Compressed Natural Gas Filter removes oil, condensation, particulate, and other contaminants from low pressure natural gas fuel systems.

How the Product Works:

The gas filter coalesces oil mist generated from the fueling compressor into large droplets that can be drained using the valve at the bottom of the housing.



Cross References with:

Baldwin	Fleetguard
P/N: 7695	P/N: NG5900

Product Features:

- Twist drain
- Powder coated housing
- High efficiency media
- Easy application spin on design

Specifications:

Part Number - PFF7695	
Thread	1 1/2 - 16
O.D.	3 25/32 in (96.0 mm)
Length	7 11/32 in (186.5 mm)
Media	Microglass
Flow Direction	Inside Out
Operating Pressure	100 PSIG
Particulate Efficiency	99.99% @ 5 micron
Coalescing Efficiency	96.5%
Weight	1.0 lb

*Gasket Included

Product Applications:

The Spin-on Compressed Natural Gas Filter fits Cummins B series natural gas engines in the following applications (please see table below).

Manufacturer	Make	Model	Description
Autocar	Trucks	WXR42	WXR42 w/ISL NG Eng.
Capacity	Trucks	TJ9000	TJ9000 w/Cummins ISL-G Eng.
Cummins	Engines	ISL-G	ISL-G Natural Gas (8.9 L)
Cummins	Engines	ISX-G	ISX-G (15.0 L)
Eldorado	Buses	Transit	Transit w/CNG Eng. (2000)
Freightliner	Truck & Buses	Business Class M2 NG	Business Class M2 NG w/Cummins ISL-G Eng.
Kenworth	Trucks	T440	T440 w/Cummins ISL-G Eng.
Kenworth	Trucks	T800	T800 w/Cummins ISL-G Eng.
Kenworth	Trucks	T800	T800 w/Westport HD GX (15.0 L) Eng.
Kenworth	Trucks	W900	W900 w/Cummins ISL-G Eng.
Mack	Trucks	MRU613	MRU613 w/Cummins ISL-G Eng.
Mack	Trucks	Terrapro	Terrapro w/Cummins ISL-G Eng.
NABI	Buses	40LF Transit	40LF Transit w/LNG Eng. (1998-2001)
Peterbilt	Trucks	365	365 w/Cummins ISL-G Eng.
Peterbilt	Trucks	367	367 w/Westport HD GX (15.0 L) Eng.
Peterbilt	Trucks	384	384 w/Cummins ISL-G Eng.
Peterbilt	Trucks	386	386 w/Cummins ISX-G Eng.
Peterbilt	Trucks	386	386 w/Westport HD GX (15.0 L) Eng.
Westport HD	Engines	GX	GX

Compact Nylon Filter With Clear Bowl

Application:

KN1S and KN5S filters are an economical way to provide high-efficiency filtration for protection of emission analyzers, air-logic systems and low-flow point-of-use pneumatic components. Includes manual, tee-valve drain (1/8" NPT port).



How to Order:

KN	1	S	—	6	C	06-016
Material	Port Size			Media Grade	Media Type	Element Size
	5 = 1/8" NPT 1 = 1/4" NPT			4 6 8 10 blank for 75P	G T F H C 75P	06-016

For Example: KN1S-6C06-016 for complete assembly, including element.

KN1S X 1 for an empty housing.

Mounting Bracket: MBS-2

Nylon Filter With Clear Bowl

Application:

The P1N offers economical high efficiency filtration for point-of-use, instrument systems or OEM circuit protection. The P1N is also used when sump and element visibility are required. Includes manual twist drain.



How to Order:

P	1	N	—	10	G	10-025
	Port Size			Media Grade	Media Type	Element Size
	1 = 1/4" NPT			4 6 8 10 blank for 3PU and AU	G QU T 3PU F AU H C CU	10-025

For Example: P1N-4QU10-025 for complete assembly, including element.

P1N X 1 for an empty housing.

Mounting Bracket: MB-2

Specifications:

Model Number	Port Size NPT	Max. Pressure	Max. Temperature	Materials of Construction			Seals	Shipping Weight
				Head	Internals	Bowl		
KN5S, KN1S	1/8" 1/4"	150 PSIG/ 10 bar	125°F (All media types)	Glass Filled Nylon	Acetal Plastic, Steel	Clear Polyurethane	Buna N	.3 lbs./ .14 kgs.
P1N	1/4"	100 PSIG/ 7 bar	125°F (All media types)	Acetal Plastic	Acetal Plastic, Stainless Steel	Clear Polyurethane	Buna N	.49 lbs./ .22 kgs.

Aluminum Filters With Clear Bowl

Application:

The QN series is an excellent point-of-use filter when element visibility is required. Coalescing, particulate and adsorption elements available. Includes plastic manual twist drain.

How to Order:



QN	15	N	—	6	C	N
	Port Size			Media Grade	Media Type	Accessories
	1 = 1/4" NPT 15 = 3/8" NPT 2 = 1/2" NPT			blank for 3PU, AU, 100WS 4 6 8 10	G QU T 3PU F AU H C CU	N = None D = Differential Pressure Indicator G = Differential Pressure Gauge

For Example: QN15N-10QUN for complete assembly, including element. QN15NN X 1 for an empty housing.
Mounting bracket: P/N BK-M

Note: Although the element size is not included in the part number construction for this filter, the size, 10-025, is needed to order replacement elements. For Example, 6C10-025 X 8.

Low Flow, Dual-Stage In Line Filters

Application:

The ILN, IKN in-lines are used for low flow circuit protection on sensing instruments, analyzers, air-logic, and other control devices. High-efficiency coalescing and particulate elements are available. Drain types available include manual push, constant bleed or no drain. **The design:** This twist-lock plastic housing is designed for 50 PSIG Maximum operating pressure. The two-stage filter design allows for high efficiency element replacement and the reuse of the 74 micron prefilter (74P05-011 X 10).



How to Order:

I	L	N	D	—	6	G	05-011
	Port Size		Type of Drain		Media Grade	Media Type	Element Size
	L = 1/8" NPT K = 1/8" NPT with brass inserts		blank for no drain; closed D = Open; constant bleed drain V = Valved; manual drain		4 6 8 10	G T F H	05-011

For Example: IKND-4G05-011 for complete assembly, including element. IKND X 1 for an empty housing.

Specifications:

Model Number	Port Size NPT	Max. Pressure	Max. Temp.	Materials of Construction			Seals	Shipping Weight
				Head	Internals	Bowl		
QN1N, QN15N, QN2N	1/4" 3/8" 1/2"	125 PSIG/ 9 bar	125°F (All media types)	Aluminum	Acetal Plastic, Stainless Steel	Clear Polyurethane	Buna N	.86 lbs./ .39 kgs.
ILN/IKN	1/8"	50 PSIG/ 3 bar	125°F (All media types)	ILN: Nylon IKN: Clear polyurethane	Neoprene	ILN: Nylon IKN: Clear polyurethane	Silicone Rubber	.1 lbs./ .05 kgs.
ILND/IKND	1/8"	50 PSIG/ 3 bar	125°F (All media types)	ILN: Nylon IKN: Clear polyurethane	Neoprene	ILN: Nylon IKN: Clear polyurethane	Silicone Rubber	.1 lbs./ .05 kgs.
ILNV/IKNV	1/8"	50 PSIG/ 3 bar	125°F (All media types)	ILN: Nylon IKN: Clear polyurethane	Neoprene	ILN: Nylon IKN: Clear polyurethane	Silicone Rubber	.1 lbs./ .05 kgs.

High Efficiency Disposable In-Line Filters

These high-efficiency, disposable in-line filters are great for analyzer and sensor protection, gas sampling, micro-system operation and robot and animation air preparation. This clear, nylon housing allows visible inspect of collected particulate. The full length internal tube support gives higher strength, even with system upsets.



Type ID In-line filters

The Type ID enclosure in conjunction with a 'G', 'T', 'F' or '44P' series element is designed to provide the most reliable, long lived, instrument air source, sensor protection, sample cleansing and purification available today. The center core provides stable backup support, reduces internal (tare) volume, centers the tube in the housing and distributes the contaminant load along the tube's entire length. Elements in the housing are sealed by a positive serrated arrangement with built-in redundancy, ultrasonically welded.

Type MD In-line filters

The Type MD housing in conjunction with a 'G', 'T', 'F' or '5P' element is designed to provide a high reliability instrument air source or sensor protection where some levels of condensed moisture or oil are present. A stand-pipe is molded into the lower housing to allow for a dry exit chamber as liquids collect at the tube base. Up to 3cc of liquid can be stored in this manner. The same tube size is employed as in the Type ID. Typical applications involve high condensate conditions such as vacuum or higher temperature systems.

Type SD In-line filters

For critical point-of-use, vapor free instrument or medical systems the Type SD provides Maximum activated surface exposure to the process gas while pre-filtering with grade 10 pads and preventing media migration with exit safety filters.

Adsorbing Media Available

- Type A: Activated carbon for general use oil vapor removal.
- Type J: Silica gel moisture trap dries gas, turns pink when expended.
- Type M: 13X molecular sieve for selective polishing and 'last trace' light hydrocarbon vapor removal.
- Type O: Activated dye turns red when exposed to oil in system.

Specifications:

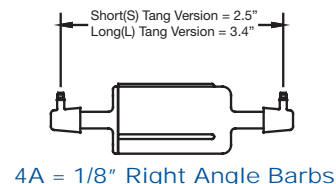
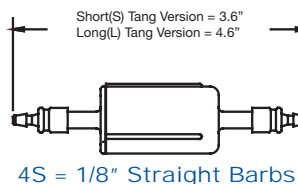
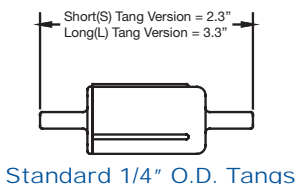

Specifications:

Model Number	Max. Pressure	Max. Temp.
ID/ SD/ MD	100 PSIG/ 7 bar	125°F (All media types)

How to Order:

1D	N	6	G	4S
Type	Tang Length	Media Grade	Media Type	End Connections
ID MD SD	N = Long S = Short	Leave blank for SD,5P,44P 4 6 8 10	Available for ID only 44P = 44 micron SS mesh Available for MD only 5P = 5 micron SS mesh Available for ID/MD G = Epoxy T = PTFE F = Fluorocarbon Available for SD only A = Activated Carbon J = Silica Gel M = Molecular Sieve O = Oil Activated Dye	blank = Standard Tangs (1/4" outer diameter) 4S = 1/8" Straight Barbs 4A = 1/8" Right Angle Barbs

For Example: IDN-6G for complete assembly, including element.

Flow Data (SCFM) and Replacement Elements

Note: Flow rates shown are for largest port size in each housing series.

Filter Housing Model	Media Grade	20 PSIG	40 PSIG	60 PSIG	80 PSIG	100 PSIG	150 PSIG	250 PSIG	500 PSIG	1500 PSIG	5000 PSIG	Replacement Elements Available *Insert grade. Quantity of elements per Box follows the 'X'		
S1R	4	2	3	4	5	6	9	15	29	85	280	*C04-023 X 10 *F04-023 X 10 *H04-023 X 10 *T04-023 X 10 *G04-023 X 10 100WS-023 X 1		
	6	3	4	6	7	8	12	19	38	111	367			
	10	3	5	7	8	10	14	23	45	132	437			
A1R	4	2	3	4	5	6	9	15	29	-	-		*G04-013 X 10 *T04-013 X 10 *F04-013 X 10	
	6	3	4	6	7	8	12	19	38	-	-			
	10	3	5	7	8	10	14	23	45	-	-			
S1IL	4	1	2	2	3	4	5	8	16	48	157			*H10-025 X 8 *F10-025 X 10 *G10-025 X 10 *T10-025 X 10 *CU09-025 X 10 *AU09-025 X 10 100WS04-023X 1
	6	1	2	3	4	5	7	11	21	62	205			
	10	2	3	4	5	6	8	13	26	75	249			
S2PS	4	5	8	10	13	16	-	-	-	-	-	*H10-070 X 4 *F10-070 X 10 *G10-070 X 10 *T10-070 X 10 *CU09-070 X 10 *AU09-070 X 10 100WS09-070 X 1		
	6	7	11	14	18	22	-	-	-	-	-			
	10	11	18	24	31	37	-	-	-	-	-			
S2SS	4	5	8	10	13	16	23	37	-	-	-		*H10-070 X 4 *F10-070 X 10 *G10-070 X 10 *T10-070 X 10 *CU09-070 X 10 *AU09-070 X 10 100WS09-070 X 1	
	6	7	11	14	18	22	32	51	-	-	-			
	10	11	18	24	31	37	53	85	-	-	-			
S2PL	4	14	22	29	37	45	-	-	-	-	-			*CU24-187 X 1 AU24-187 X 1 7CVP24-187 X 1 100WS24-187 X 1 3PU24-187 X 1
	6	18	29	39	50	60	-	-	-	-	-			
	10	32	50	68	86	104	-	-	-	-	-			
S2SL	4	14	22	29	37	45	65	104	-	-	-	*HM06-013 X 10 AM06-013 X 10		
	6	18	29	39	50	60	86	138	-	-	-			
	10	32	50	68	86	104	149	240	-	-	-			
SN8S	4	103	162	221	281	340	488	785	1526	-	-		*HM06-013 X 10 AM06-013 X 10	
	6	136	215	293	372	450	646	1038	2019	-	-			
	10	227	358	488	619	750	1077	1731	3366	-	-			
Q1S	4	2	3	4	5	6	8	-	-	-	-			*HM06-013 X 10 AM06-013 X 10
	6	2	4	5	6	8	11	-	-	-	-			
	10	4	6	9	11	13	19	-	-	-	-			
H1S	4	2	3	4	5	6	8	13	-	-	-	*HM06-013 X 10 AM06-013 X 10		
	6	2	4	5	6	8	11	18	-	-	-			
	10	4	6	9	11	13	19	30	-	-	-			

Flow Data (SCFM) and Replacement Elements

Note: Flow rates shown are for largest port size in each housing series.

Filter Housing Model	Media Grade	20 PSIG	40 PSIG	60 PSIG	80 PSIG	100 PSIG	150 PSIG	250 PSIG	500 PSIG	1500 PSIG	5000 PSIG	Replacement Elements Available *Insert grade. Quantity of elements per Box follows the 'X'
KN1S	4	2	4	5	7	8	11	-	-	-	-	*C06-016 X 10
	6	3	5	7	8	10	14	-	-	-	-	*F06-016 X 10
	10	5	8	11	14	17	24	-	-	-	-	*H06-016 X 10 *T06-016 X 10 *G06-016 X 10 75P06-016 X 10
P1N, QN1N	4	3	5	7	9	11	-	-	-	-	-	*C10-025 X 8
	6	5	7	10	12	15	-	-	-	-	-	*QU10-025 X 8
	10	6	10	13	17	20	-	-	-	-	-	*CU10-025 X 8 *G10-025 X 10 *H10-025 X 8 *T10-025 X 8 *F10-025 X 10 3PU10-025 X 8 AU10-025 X 8
QN15N, QN1N QN2N	4	6	10	14	17	21	-	-	-	-	-	*C10-025 X 8
	6	9	13	18	23	28	-	-	-	-	-	*QU10-025 X 8
	10	16	26	35	45	54	-	-	-	-	-	*CU10-025 X 8 *G10-025 X 10 *H10-025 X 8 *T10-025 X 8 *F10-025 X 10 3PU10-025 X 8 AU10-025 X 8
ILNV, IKNV ILND, IKND ILN, IKN	4	1.3	2.0	-	-	-	-	-	-	-	-	*H05-011 X 10
	6	1.7	2.7	-	-	-	-	-	-	-	-	*T05-011 X 10
	10	2.8	4.5	-	-	-	-	-	-	-	-	*G05-011 X 10 74P05-011 X 10 *F05-011 X 10
ID, MD	4	0.8	1.3	1.8	2.2	2.7	-	-	-	-	-	Note: These filters are disposable and sold in Box quantities of 10. No replacement elements available.
	6	1.1	1.7	2.3	2.9	3.5	-	-	-	-	-	
	10	1.6	2.5	3.5	4.4	5.3	-	-	-	-	-	
SD	A	0.5	0.9	1.2	1.5	1.8	-	-	-	-	-	Note: These filters are disposable and sold in Box quantities of 10. No replacement elements available.
	J	0.5	0.9	1.2	1.5	1.8	-	-	-	-	-	
	M	0.5	0.9	1.2	1.5	1.8	-	-	-	-	-	
	O	1.4	2.2	3.1	3.9	4.7	-	-	-	-	-	



Exhaust Coalescing Silencers and Mufflers

Bulletin 1300 - 330/USA Rev A



ENGINEERING YOUR SUCCESS.

Exhaust Coalescing Silencers

Improve Overall Plant Environment:

Exhaust oil mist and noise pollution have a direct impact on worker productivity and their environment.

Oil aerosol mist from lubricators and compressors is pervasive and enters the industrial plant environment through

the exhaust ports of valves, cylinders and air motors. This rapidly expanding exhaust also produces sudden and excessive noise.

The Finite Exhaust Coalescing Silencer (ECS) is 99.97% efficient at removing

the oil aerosols. The ECS also acts as a silencer to lower the dBA levels to below O.S.H.A. requirements.

The result is a cleaner, quieter, environment which equates to greater work productivity and safety.

How It Works:

Compressor oils and lubricating oils are exhausted from valves, cylinders and air motors into the ECS. Oil aerosols are coalesced into larger droplets and gravity pulls them into the attached drain sump. The sump can then be drained manually or by using a 1/4" ID plastic tube drain. The air flowing into the ECS is also muffled or silenced as it enters the inside of the ECS and passes through the filter media into the atmosphere.



Features and Benefits:

- 99.97% oil removal efficiencies
- 25 dBA Noise attenuation
- 1/2" and 1" NPT
- Disposable Units
- Continuous or plugged drain option
- Metal retained UNI-CAST construction
- Fast exhaust time
- BSP (G) Thread option

Parker Finite Technology:

ECS units are constructed from the same materials that go into our oil removal coalescing filter elements. Finite's UNICAST seamless design insures media uniformity and strength. This proven technology provides high coalescing efficiency with low pressure drop.

The filter media is supported by cylindrical perforated steel retainers both inside and out. These retainers, galvanized for excellent corrosion resistance, give Finite's ECS units high rupture strength in either flow direction. ECS units can also be used as high efficiency inlet or bypass filters for vacuum pumps, or breather elements to protect the air above critical process liquids.

Eliminates unwanted oil mist and reduces exhaust noise from pneumatic valves, cylinders and air motors

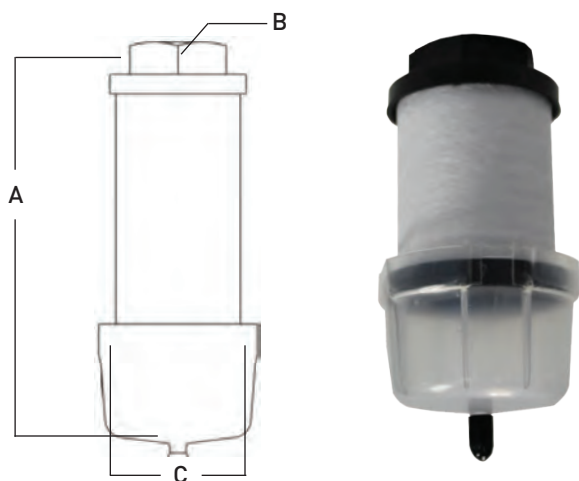
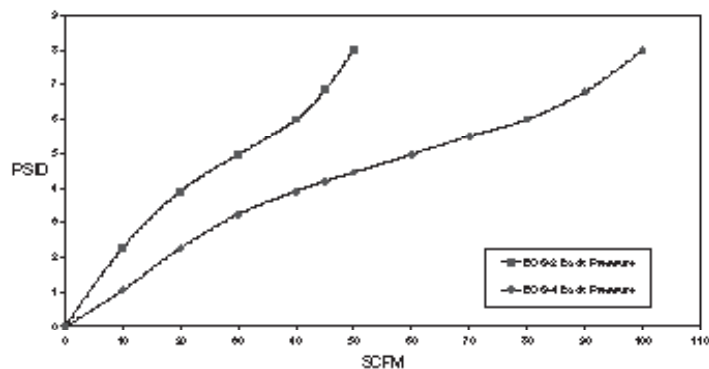
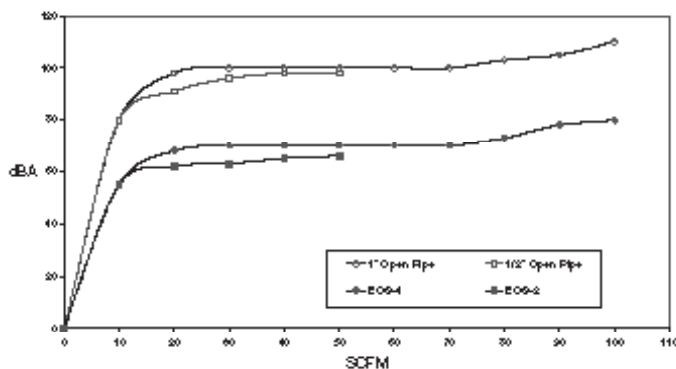

- ### Typical Applications:
- Valve Exhaust
 - Cylinder Exhaust
 - Air Motor Exhaust
 - Noise Reduction
 - Oil Mist Elimination
 - Safer Work Environment
 - Tank Vents
 - Vacuum Exhaust

Performance Specifications:

Maximum operating temperature: 125°F/52°C
 Maximum line pressure: 100 PSIG/7bar

Dimensions:

Model Number	A	B	C
ECS-2	5.3" (135mm)	1/2" NPT	2.57" (65mm)
ECS-4	7.3" (185mm)	1" NPT	2.57" (65mm)
ECSB-2	5.3" (135mm)	1/2" BSP	2.57" (65mm)
ECSB-4	7.3" (185mm)	1" BSP	2.57" (65mm)

How to Order

Use the following model numbers to place an order:

- For NPT Porting:**
 ECS-2 x 1 (1/2" NPT)
 ECS-4 x 1 (1" NPT)
 ECS-2 x 6 (1/2" NPT - Carton of 6)
 ECS-4 x 6 (1" NPT - Carton of 6)

- For BSP Porting:**
 ECSB-2 x 1 (1/2" BSP - Parallel (G))
 ECSB-4 x 1 (1" BSP - Parallel (G))
 ECSB-2 x 6 (1/2" BSP - Parallel (G) - Carton of 6)
 ECSB-4 x 6 (1" BSP - Parallel (G) - Carton of 6)

Parker Finite Vacuum Pump Exhaust Filters

What is a Vacuum Pump and what is it used for?

High Quality, Low Maintenance

Vacuum pumps are used in a variety of applications from manufacturing processes to medical devices. In general, a vacuum pump provides high quality, reliable performance and is a low maintenance piece of equipment.

How it Works

Vacuum pumps convert mechanical energy into pneumatic energy by evacuating the air contained within a system. They use the same pumping mechanism as air compressors except that the unit is installed so that the air is drawn from a closed volume and exhausted to the atmosphere.

In a compressed air system the compressor inlet is usually at atmospheric pressure, whereas in a vacuum system, the outlet is at atmospheric pressure.

Lubricated vs. Non-lubricated

Pumps are generally offered in an oil-less or oil-lubricated version. Oil-lubricated vacuum pumps have many advantages if they are properly maintained. They can usually provide 20% higher vacuum because the lubricant acts as a sealant. The life of an oil-lubricated vacuum pump is usually extended by 50% due to cooler operation and better protection against corrosion from condensed water vapor.

All Pumps Require Filtration Protection

A vacuum pump, whether it is oil-less or not, requires exhaust filtration protection. One requirement of vacuum pump maintenance is making sure that the operator provides and maintains a filter for the vacuum exhaust. Regardless of the type of vacuum pump you have, using a Finite exhaust filter will ensure a cleaner work environment.

Why filter Vacuum Pump exhaust?

Put 99.9% clean air into YOUR work environment

A vacuum pump will exhaust smoke and visible oil mist into the air. Installing a Finite exhaust filter from Parker Hannifin will eliminate 99.9% of the oil mist and smoke from vacuum pump exhaust. This will prevent oil accumulation in the ambient air, which could otherwise cause health hazards for employees and potential violations from OSHA and the EPA.

Eliminate oil in duct work

When oily air is emitted from a vacuum pump, the contaminants are circulated throughout the building through the duct work. This can create dirty intake air for other equipment such as air compressors, packaging machines, etc.

Recover expensive lubricating oils

Oil prices have risen dramatically in the past few years. Your Finite vacuum pump exhaust filter can recover expensive lubricating oils and return filtered oil back to the pump. This reduces overall maintenance costs.

Features and Benefits:

- Eliminate 99.9% oil mist and smoke from vacuum pump exhaust
- Easily adapts to most vacuum pumps
- Flows to 200 CFM



Compressed Air & Gas Desiccant Dryers

For Point of Use and OEM Applications

FDD-Series Hollow Fiber Membrane Technology

- 1/4" to 1" NPT Ports
- Capacities to 60 SCFM
- Pressure Dewpoints Down to -40° F

Finite® Filter's unique in-line air/gas dryer system is engineered for easy desiccant changeouts, longer life and lower pressure drop.

The FDD Series is designed to remove water vapor and aerosols at point-of-use for intermittent flows up to 60 SCFM. Finite dryers do not require steady flow for constant dewpoint suppression.

A color changing moisture indicator with visual sight gauge indicates the need for desiccant replacement.

STANDARD FEATURES

- Zinc Head/Steel Bowl with Integral Sightglass
- Sintered Bronze Elements (prevent desiccant carry over)
- Collar Designed for Easy Changeouts
- Maximum Operating Temperature: 180° F
- Maximum Working Pressure: 300 PSI
- Optimum Working Temperature: Below 100° F



The new FDD Series offers clean dry air for intermittent usage.

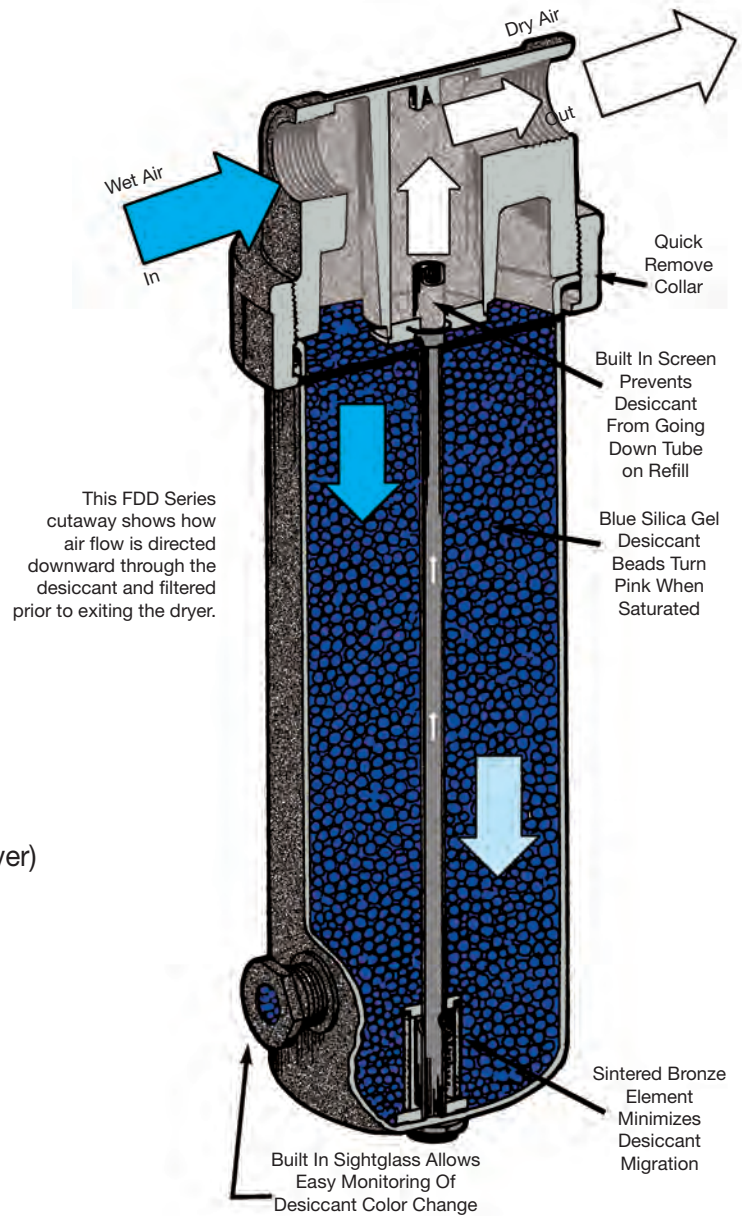

APPLICATIONS

- Intermittent Air Use
- Clean, Dry Air for Pneumatic Applications
- Instrument Protection
- Air Tools Protection Against Gumming and Oxidation
- Auto Body Paint Systems - Helps Prevent Fish Eye Defects
- Valve Actuation - Instrument Air

DESICCANT TYPES

SILICA GEL — Finite Filter’s 100 percent indicating silica gel provides Maximum moisture adsorption and dewpoints down to -40° F.

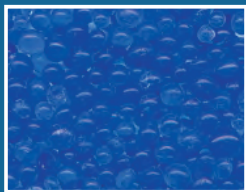

Silica Gel a popular choice for the FDD series.

Outstanding features of Silica Gel include:

- High adsorption capacity - average surface area for each bead is over 200 ft²
- Low abrasion, due to high mechanical strength for long service life
- Ideal packing in bowl due to bead shape
- Uniform color change
- Excellent regeneration characteristics

As the silica beads adsorb moisture, they change from blue to pink, indicating the need for replacement or regeneration. The desiccant can be regenerated by heating in a drying oven to a temperature higher than 212° F but not over 350° F. Desiccant may also be regenerated in microwave ovens.

MOLECULAR SIEVE — Molecular sieves are crystalline, metallic aluminum silicates. The type 4A offers exceptional water vapor adsorption characteristics. Dewpoints are attainable to -40° F.

RECOMMENDED INSTALLATION

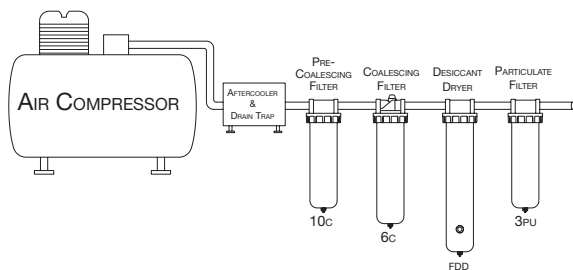

- Always place a moisture separator and/or pre-coalescing filter upstream to remove bulk liquids
- Always place a coalescing filter upstream to remove oil. Desiccant coated with oil will not adsorb moisture
- A 3 micron (or better) particulate filter is recommended downstream to remove desiccant dust in critical applications

WHY FINITE DESICCANT DRYERS?

Finite® desiccant dryers are the simplest and most reliable method of ensuring your sensitive pneumatic equipment is not exposed to damaging moisture. When air is compressed, the temperature of air is increased as is its capacity to hold moisture. As the hot moist air travels downstream through the pipelines, it cools, allowing the moisture to condense. Aftercoolers, filters, drain traps and drip legs are effective for removing condensate. For removing residual water vapor and aerosols, use the Finite desiccant dryer.



FDD15
 • 1/4" - 3/4" NPT
 • Flows to 15 SCFM
 • Low Flow Intermittent Use



FDD30
 • 3/8" - 1" NPT
 • Flows to 30 SCFM
 • Medium Flow for Intermittent Use or Longer Time Between Desiccant Changeouts



FDD60
 • 1/2" - 1" NPT
 • Flows to 60 SCFM
 • For Intermittent Use or Longer Time Between Desiccant Changeouts

How Do THEY WORK?

As the wet compressed air flows through the inlet port and down through the bed of desiccant, the desiccant beads adsorb the water vapor and aerosols. The silica gel beads are so effective in adsorption, the air humidity can be reduced to a -40° F pressure dew point. Unless your compressed air is exposed to a temperature below the dewpoint, there will be no further condensation forming in your air lines.

After the moisture has been removed, the dry air passes through a sintered bronze element, up the center tube, and exits through the outlet port. As long as the desiccant is replaced regularly, your equipment will receive ultra dry, moisture-free air.



This sight gauge shows the color of the silica gel. When the gel turns from blue to pink, it is time to change the desiccant.

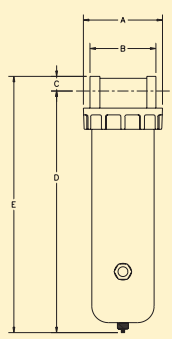

DIMENSIONS

	A*	B*	C	D	E	Weight
FDD15	4 15/16	4 1/16	13/16	12 11/16	13 1/2	8 lbs.
FDD30	4 15/16	4 1/16	13/16	22 7/16	23 1/4	13 lbs.
FDD60	4 15/16	4 1/16	13/16	29 7/16	30 1/4	20 lbs.

*Dimensions A & B do not include reducer bushings.
 Note: Weight is for housing only. Bowl removal requires a minimum of 2".

ORDERING INFORMATION

MODEL No. HOUSING ONLY**	PIPE SIZE (NPT)	FLOW CAPACITY	BOWL CAPACITY DESICCANT (LBS)
FDD15-02*	1/4"	15 SCFM	2 1/2
FDD15-03*	3/8"	15 SCFM	2 1/2
FDD15-04*	1/2"	15 SCFM	2 1/2
FDD15-06	3/4"	15 SCFM	2 1/2
FDD30-03*	3/8"	30 SCFM	5
FDD30-04*	1/2"	30 SCFM	5
FDD30-06*	3/4"	30 SCFM	5
FDD30-08	1"	30 SCFM	5
FDD60-04*	1/2"	60 SCFM	10
FDD60-06*	3/4"	60 SCFM	10
FDD60-08	1"	60 SCFM	10

*These dryers supplied with reducer bushings.
 **Desiccant sold separately.

PERFORMANCE

The flow capacities in the table are nominal ratings provided for reference. These capacities are recommended for minimal pressure drop and average desiccant life. A supply of low flow/low humidity air will provide longer desiccant life, whereas high flow/high humidity air will require more frequent desiccant changes.

Installed in an application with intermittent flow, Finite desiccant dryers will typically dry air for weeks before the silica gel desiccant requires replacement or regeneration.

DID YOU KNOW?

When a grade 6 microglass coalescer is installed ahead of an FDD Dryer, 99.97% of all contaminants are removed and desiccant life is greatly enhanced.

DESICCANT TYPE	5 LB CAN	MASTER PACK 4x5 LB CAN
Silica Gel (all indicating)	FSGM100-1	FSGM100-4
Molecular Sieve (non-indicating)	FMS100-1	FMS100-4

For detailed performance curves, please contact Finite® Filter.

SPARE PARTS

MODEL NUMBER	REPAIR KIT	ELEMENTS
FDD15	FRKDD15-02-06	504Z77-90
FDD30	FRKDD30-03-08	504Z77-90
FDD60	FRKDD60-03-08	EK602B-BR

Note: A repair kit consists of a filter element, filter retainer, o-ring, stud, bottom nut, PVC tube and a strainer.

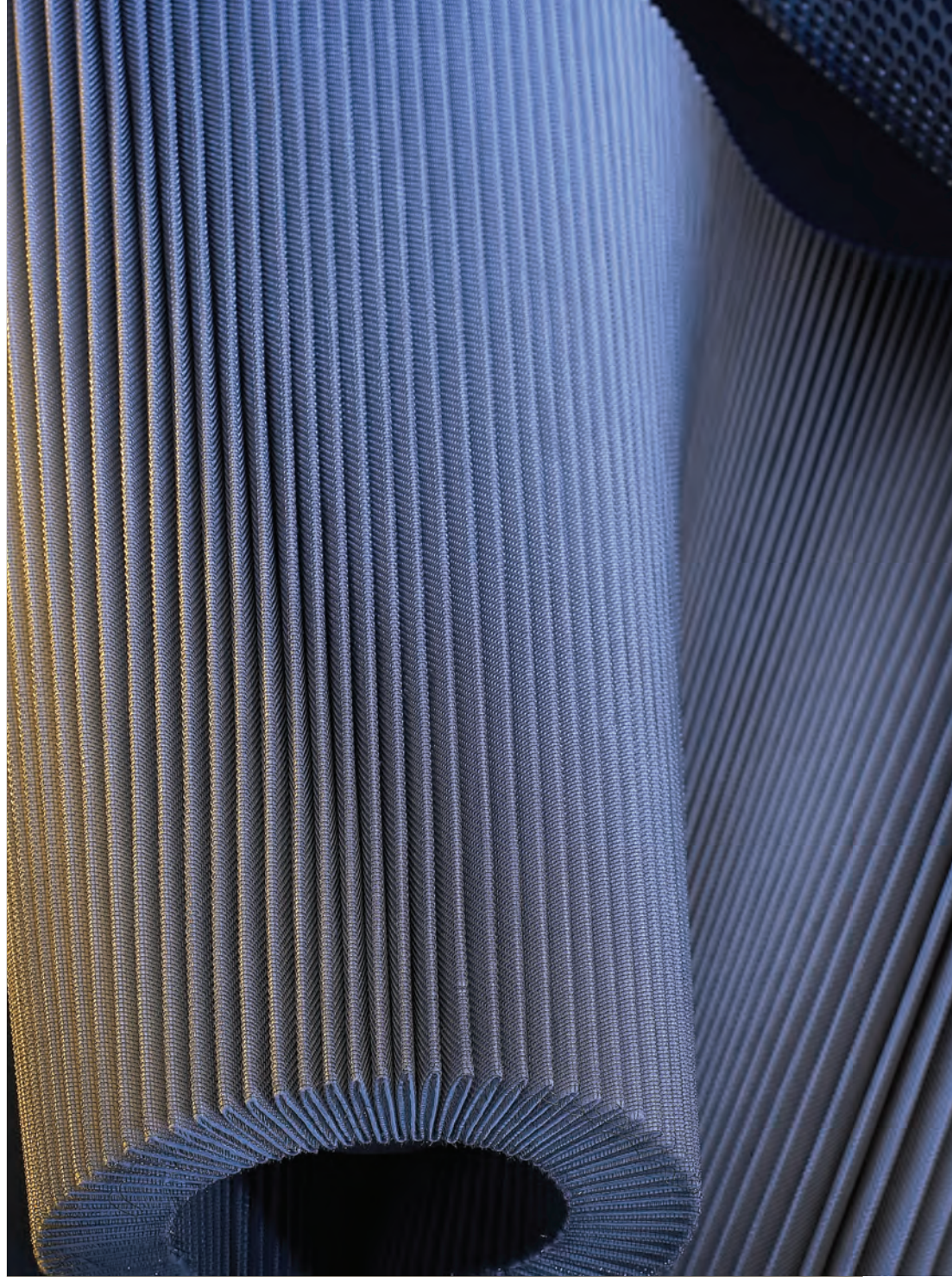

Par-Fit™ Conversion Elements

Bulletin 1300 - 500-2/USA



ENGINEERING YOUR SUCCESS.

The Parker Advantage

All of the benefits inherent in a Parker filter element without the need to replace your existing filter housing.

Advantages

High filtration efficiency, low operating costs, long life, high quality, and the convenience of purchasing your products from a single supplier are the Parker advantages.

The Solution

Each Parker coalescing filter element offers our unique UNI-CAST design created from a carefully controlled vacuum process. This design was developed and patented by Parker to optimize filter performance — resulting in a filter element with lower differential pressure and higher dirt loading capacity. This means lower operating costs and longer life.

Having complete control over the manufacturing process allows for greater control over product quality. Parker Finite's filtration elements offer reliable and consistent filtration performance. Our efficiency standards are among the highest in the industry — consistently meeting or exceeding the filtration performance and flow rate capacity of the original element. We verify these standards in our quality control laboratory in order to ensure the industry leading filtration quality.

Parker is a pioneer in coalescing filtration technology. We are dedicated to the science of this filtration technique. By purchasing a Parker product you will have access to decades of coalescing experience and research. With the breadth of our product line, including complete filter housings, most of your needs will be met with a single source, high quality, reliable supplier.

Call your Parker distributor today for your filtration needs. Or, your questions can be answered by calling 888-587-9733. Ask for Applications Engineering. Parker's benefits are available to you, now!

Table of Contents:

Arrow	124
Binks®	124
Busch	124
Cuno® (AMF Cuno)	125
Filterite	125
Filtersoft®	125
Flair	129
Hankison®	131
Headline	132
Henderson	133
Ingersoll Rand	133
Johnson Controls	133
Pall / Pneumatic Products Corp.	133
Pioneer	135
Pneumatech / Atlas Copco	135
Pure Air	136
Steris®	136
Sullair®	136
Ultra Air	136
Ultrafilter / Donaldson®	137
Van Air®	138
Zeks®	139
Zurn® / General Air Dryer	139

General Notes:

1. To make a proper conversion, locate the original manufacturer's element number, determine the element type (coalescer, particulate or adsorber), then identify the Parker equivalent from the proper manufacturer's list.
2. The grades and types of Parker elements recommended are based on the actual performance specifications of the housings to be converted.
3. Number after "X" in "Parker Element Part Number" indicates number of elements sold per box. Elements are sold in box quantity only.
4. Conversion kits consist of a group of parts, such as center rods and end caps, that adapt other manufacturer's housings to accept a Parker conversion element.
5. Conversion kits are required for initial conversion only.

Alphabetical Listing by Competitor

Competitor Part Number	Parker Finite Part Number	Kit Required
------------------------	---------------------------	--------------

Arrow

Oil Removal

EKF401	10RU07-018 x 8	—
EKF402	10RU10-021 x 8	—
EKF405	10RA20-040 x 4	—
EKF407	10RA20-071 x 2	—
EKF408	10RA20-080 x 2	—
EKF410	10RU25-101 x 2	—
EKF418	10RU25-181 x 1	—
EKF428	10RU25-281 x 1	—
EKF4N2	10RU25-281 x 1	—
EKF4 x 2	10RU25-281 x 1	—
EKF4 x 3	10RU25-281 x 1	—
EKF4 x 4	10RU25-281 x 1	—
EKF4 x 5	10RU25-281 x 1	—
EKF4 x 6	10RU25-281 x 1	—
EKF4 x 8	10RU25-281 x 1	—

Coalescer

EKF501	6CU07-018 x 8	—
EKF502	6CU10-022 x 8	—
EKF505	6IA20-040 x 4	—
EKF507	6IA20-071 x 2	—
EKF508	6IA20-080 x 2	—
EKF510	6IU25-101 x 2	—
EKF518	6IU25-181 x 1	—
EKF528	6IU25-281 x 1	—
EKF529	6CA29-280 x 1	—
EKF5N2	6IU25-281 x 1	—
EKF5 x 2	6IU25-281 x 1	—
EKF5 x 3	6IU25-281 x 1	—
EKF5 x 4	6IU25-281 x 1	—
EKF5 x 5	6IU25-281 x 1	—
EKF5 x 6	6IU25-281 x 1	—
EKF5 x 8	6IU25-281 x 1	—

Fine Coalescer Grade A

EKF501A	4CU07-018 x 8	—
EKF502A	4CU10-022 x 8	—
EKF505A	4IA20-040 x 4	—
EKF507A	4IA20-071 x 2	—
EKF508A	4IA20-080 x 2	—
EKF510A	4IU25-101 x 2	—

Competitor Part Number	Parker Finite Part Number	Kit Required
------------------------	---------------------------	--------------

EKF518A	4IU25-181 x 1	—
EKF528A	4IU25-281 x 1	—
EKF529A	4CA29-280 x 1	—
EKF5N2A	4IU25-281 x 1	—
EKF5 x 2A	4IU25-281 x 1	—
EKF5 x 3A	4IU25-281 x 1	—
EKF5 x 4A	4IU25-281 x 1	—
EKF5 x 5A	4IU25-281 x 1	—
EKF5 x 6A	4IU25-281 x 1	—
EKF5 x 8A	4IU25-281 x 1	—

Vapor Adsorber

EKF601	AU07-018 x 8	—
EKF602	AU10-022 x 8	—
EKF605	AA20-040 x 4	—
EKF607	AA20-071 x 2	—
EKF608	AA20-080 x 2	—
EKF610	AU25-101 x 2	—
EKF618	AU25-181 x 1	—
EKF628	AU25-281 x 1	—
EKF629	AA29-280 x 1	—
EKF6N2	AU25-281 x 1	—
EKF6 x 2	AU25-281 x 1	—
EKF6 x 3	AU25-281 x 1	—
EKF6 x 4	AU25-281 x 1	—
EKF6 x 5	AU25-281 x 1	—
EKF6 x 6	AU25-281 x 1	—
EKF6 x 8	AU25-281 x 1	—

Note: Parker provides replacement elements only. If end caps and center rods are not reusable, consult factory.

Binks®

86-972	6HU20-070 x 2	—
86-982	6HU10-050 x 4	—

Busch

532-221	8CF20-051 x 2	—
532-302 (532.509.01)	8CF20-099 x 2	—
532-303 (532.082.01)	8CF20-147 x 1	—
532-304 (532.507.01)	8CF20-197 x 1	—

Competitor Part Number	Parker Finite Part Number	Kit Required
------------------------	---------------------------	--------------

Cuno® (AMF Cuno)

Reverse Flow Coalescer

9-3/4" (78 Series)	6CP15-098 x 2	—
10" (80 Series)	6CP15-100 x 2	—
3-3/4" (30 Series)	6CP15-038 x 4	—

3µm Nominal Particulate

G78A3 (9-3/4")	3PP15-098 x 2	—
G78B2 (9-3/4")	3PP15-098 x 2	—
G80A3 (10")	3PP15-100 x 2	—
G80B2 (10")	3PP15-100 x 2	—
U78A3 (9-3/4")	3PP15-098 x 2	—
U78B2 (9-3/4")	3PP15-098 x 2	—
U80A3 (10")	3PP15-100 x 2	—
U80B2 (10")	3PP15-100 x 2	—

Activated Carbon

9-3/4" (78 Series)	AP15-098 x 2	—
10" (80 Series)	AP15-100 x 2	—

Filterite

Coalescer (Reverse Duo-Fine)

10" Element	6CP15-100 x 2	—
20" Element	6CP15-198 x 2	—

Particulate 3u (Duo-Fine After-Filter)

10" Element	3PP15-100 x 2	—
20" Element	3PP15-198 x 2	—

Adsorber (Micro-Carbon - A)

10" Element	AP15-100 x 2	—
20" Element	AP15-198 x 2	—

Filtersoft®

F05013VE-T	10G04-013 x 10	—
F05013VE-W	10H04-013 x 10	—
F05013WE-T	8T04-013 x 10	—
F05013WE-W	8H04-013 x 10	—
F05013XE-T	6G04-013 x 10	—
F05013XE-W	6H04-013 x 10	—
F05023VE-T	10G04-023 x 10	—
F05023VE-W	10H04-023 x 10	—
F05023VH-TB	10T04-023 x 10	—
F05023WE-T	8T04-023 x 10	—

Competitor Part Number	Parker Finite Part Number	Kit Required
------------------------	---------------------------	--------------

F05023WE-W	8H04-023 x 10	—
F05023XE-T	6G04-023 x 10	—
F05023XE-W	6H04-023 x 10	—
F05023XH-TB	6T04-023 x 10	—
F07013QE-CU	14JU07-013 x 10	—
F10020QE-CU	14JU10-020 x 10	—
F10020VE-W	10H10-020 x 8	—
F10020XE-W	6H10-020 x 8	—
F10025VE-T	10G10-025 x 10	—
F10025VE-W	10H10-025 x 8	—
F10025VH-TB	10T10-025 x 10	—
F10025WE-T	8T10-025 x 10	—
F10025WE-W	8H10-025 x 8	—
F10025XE-T	6G10-025 x 10	—
F10025XE-W	6H10-025 x 8	—
F10025XH-TB	6T10-025 x 10	—
F10050VE-W	10H10-050 x 4	—
F10050WE-W	8H10-050 x 4	—
F10050XE-W	6H10-050 x 4	—
F10070VE-T	10G10-070 x 10	—
F10070VE-W	10H10-070 x 4	—
F10070VH-TB	10T10-070 x 10	—
F10070WE-T	8T10-070 x 10	—
F10070WE-W	8H10-070 x 4	—
F10070XE-T	6G10-070 x 10	—
F10070XE-W	6H10-070 x 4	—
F10070XH-TB	6T10-070 x 10	—
F15043QE-CU	14JU15-043 x 10	—
F15060AU	AB15-060 x 4	—
F15060AU	AU15-060 x 4	—
F15060VE-T	10G15-060 x 10	—
F15060VE-W	10H15-060 x 4	—
F15060WE-W	8H15-060 x 4	—
F15060XE-T	6G15-060 x 10	—
F15060XE-W	6H15-060 x 4	—
F20035VE-W	10H20-035 x 4	—
F20035WE-W	8H20-035 x 4	—
F20035XE-W	6H20-035 x 4	—
F20090AU	AB15-084 x 2	—
F20090VE-T	10G20-090 x 10	—
F20090VE-W	10H20-090 x 2	—
F20090WE-W	8H20-090 x 2	—
F20090XE-T	6G20-090 x 10	—
F20090XE-W	6H20-090 x 2	—
F20187AU	AP15-180 x 2	—
F20187VE-T	10G20-187 x 10	—

Competitor Part Number	Parker Finite Part Number	Kit Required	Competitor Part Number	Parker Finite Part Number	Kit Required
F20187VE-W	10H20-187 x 1	—	FA2050XE-CB	8CZ20-200 x 1	—
F20187WE-W	8H20-187 x 1	—	FA2050YE-CB	6CZ20-200 x 1	—
F20187XE-T	6G20-187 x 10	—	FA3050AP-AB	AZ27-200 x 1	—
F20187XE-W	6H20-187 x 1	—	FA3050K-CB	3PZ27-200 x 1	—
F20198AU	AP15-198 x 2	—	FA3050WE-CB	10CZ27-200 x 1	—
F26075QE-CU	14JU26-075 x 4	—	FA3050XE-CB	8CZ27-200 x 1	—
F26120QE-CU	14JU26-120 x 4	—	FA3050YE-CB	6CZ27-200 x 1	—
F26240QE-CU	14JU26-240 x 4	—	FA3075AP-AB	AZ27-298 x 1	—
FA1030AP-AB	AZ07-020 x 1	—	FA3075K-CB	3PZ27-298 x 1	—
FA1030K-CB	3PZ07-020 x 1	—	FA3075WE-CB	10CZ27-298 x 1	—
FA1030WE-CB	10CZ07-020 x 1	—	FA3075XE-CB	8CZ27-298 x 1	—
FA1030XE-CB	8CZ07-020 x 1	—	FA3075YE-CB	6CZ27-298 x 1	—
FA1030YE-CB	6CZ07-020 x 1	—	FA5075AP-AB	AZ50-298 x 1	—
FA1050AP-AB	AZ12-023 x 1	—	FA5075K-CB	3PZ50-298 x 1	—
FA1050K-CB	3PZ12-023 x 1	—	FA5075WE-CB	10CZ50-298 x 1	—
FA1050WE-CB	10CZ12-023 x 1	—	FA5075XE-CB	8CZ50-298 x 1	—
FA1050XE-CB	8CZ12-023 x 1	—	FA5075YE-CB	6CZ50-298 x 1	—
FA1050YE-CB	6CZ12-023 x 1	—	FB302VE-CB	8CF20-099 x 2	—
FA1070AP-AB	AZ12-029 x 1	—	FB303VE-CB	8CF20-147 x 1	—
FA1070K-CB	3PZ12-029 x 1	—	FB304VE-CB	8CF20-197 x 1	—
FA1070WE-CB	10CZ12-029 x 1	—	FE006AAYE-CB	6CF08-026 x 1	—
FA1070XE-CB	8CZ12-029 x 1	—	FE006AOVE-CBM	10CF08-026 x 1	—
FA1070YE-CB	6CZ12-029 x 1	—	FE013AAYE-CB	6IF10-032 x 1	—
FA1140AP-AB	AZ12-056 x 1	—	FE013AOVE-CBM	10IF10-032 x 1	—
FA1140K-CB	3PZ12-056 x 1	—	FE025AAYE-CB	6IF10-046 x 1	—
FA1140WE-CB	10CZ12-056 x 1	—	FE025AOVE-CBM	10IF10-046 x 1	—
FA1140XE-CB	8CZ12-056 x 1	—	FE040AAYE-CB	6IF20-063 x 1	—
FA1140YE-CB	6CZ12-056 x 1	—	FE040AOVE-CBM	10IF20-063 x 1	—
FA2010AP-AB	AZ20-046 x 1	—	FE085AAYE-CB	6IF20-102 x 1	—
FA2010K-CB	3PZ20-046 x 1	—	FE085AOVE-CBM	10IF20-102 x 1	—
FA2010WE-CB	10CZ20-046 x 1	—	FE195AAYE-CB	6IF25-134 x 1	—
FA2010XE-CB	8CZ20-046 x 1	—	FE195AC-AB	AF25-134 x 1	—
FA2010YE-CB	6CZ20-046 x 1	—	FE195AOVE-CBM	10IF25-134 x 1	—
FA2020AP-AB	AZ20-086 x 1	—	FE295AAYE-CB	6IF25-254 x 1	—
FA2020K-CB	3PZ20-086 x 1	—	FE295AC-AB	AF25-254 x 1	—
FA2020WE-CB	10CZ20-086 x 1	—	FE295AOVE-CBM	10IF25-254 x 1	—
FA2020XE-CB	8CZ20-086 x 1	—	FE400AAYE-CB	6CF35-165 x 1	—
FA2020YE-CB	6CZ20-086 x 1	—	FE400AC-AB	AF35-165 x 1	—
FA2030AP-AB	AZ20-126 x 1	—	FE400AOVE-CBM	10CF35-165 x 1	—
FA2030K-CB	3PZ20-126 x 1	—	FE500AAYE-CB	6CF43-252 x 1	—
FA2030WE-CB	10CZ20-126 x 1	—	FE500AC-AB	AF43-252 x 1	—
FA2030XE-CB	8CZ20-126 x 1	—	FE500AOVE-CBM	10CF43-252 x 1	—
FA2030YE-CB	6CZ20-126 x 1	—	FH71311YE-CB	6CH25-260 x 1	—
FA2050AP-AB	AZ20-200 x 1	—	FH7139YE-CB	6CH25-260 x 1	—
FA2050K-CB	3PZ20-200 x 1	—	FH71511-AB	AH25-260 x 1	—
FA2050WE-CB	10CZ20-200 x 1	—	FH7159-AB	AH25-260 x 1	—

Competitor Part Number	Parker Finite Part Number	Kit Required	Competitor Part Number	Parker Finite Part Number	Kit Required
FH7319VE-CB	10CH25-260 x 1	—	FS1367YE-CB	6CJ25-240 x 1	—
FI1306XE-C	6C85-250 x 1	—	FS1368YE-CB	6CJ25-240 x 1	—
FI1355XE-C	6C85-250 x 1	—	FS1370-AB	AJ25-240 x 1	—
FI1645XE-C	6C85-360 x 1	—	FS1372-AB	AJ25-120 x 2	—
FI1777XE-C	6C85-360 x 1	—	FS1373-AB	AJ25-120 x 2	—
FP14051J-PB	3PP14-051 x 4	—	FS1375-AB	AJ25-240 x 1	—
FP14051XE-CB	6QP14-051 x 4	—	FS1377-AB	AJ25-240 x 1	—
FP19098J-PU	3PP19-098 x 2	—	FS1378-AB	AJ25-240 x 1	—
FP19098VH-RS	10DP19-098 x 2	—	FS1379-AB	AJ25-240 x 1	—
FP19098VH-RSI	10DPS19-098 x 2	—	FS1407YE-CB	6CJ25-120 x 2	—
FP19098XE-CU	6QP19-098 x 2	—	FS1408YE-CB	6CJ25-240 x 1	—
FP19098XE-DB	6QP19-098 x 2	—	FS1412-AB	AJ25-120 x 2	—
FP19098XK-CB	6QP19-098 x 2	—	FS1413-AB	AJ25-240 x 1	—
FP19198J-PU	3PP19-198 x 2	—	FS1413YE-CB	6CJ25-240 x 1	—
FP19198VH-RS	10DP19-198 x 2	—	FS1418-AB	AJ25-240 x 1	—
FP19198VH-RSI	10DPS19-198 x 2	—	FS5025-AB	AJ25-240 x 1	—
FP19198XE-CU	6QP19-198 x 2	—	FS5027-AB	AJ25-240 x 1	—
FP19198XE-DB	6QP19-198 x 2	—	FUF0205WE-CB	10HJN08-024 x 1	—
FP19298XE-CU	6QP19-298 x 1	—	FUF0305WE-CB	10HJN08-030 x 1	—
FP19298XE-DB	6QP19-298 x 1	—	FUF0310WE-CB	10CJN10-030 x 1	—
FP26132J-PU	3PP26-132 x 2	—	FUF0410WE-CB	10CJN10-040 x 1	—
FP26132VH-RS	10DP26-132 x 2	—	FUF0420WE-CB	10CJN13-040 x 1	—
FP26132XK-CBI	6QP28-132 x 2	—	FUF0520WE-CB	10CJN13-050 x 1	—
FP26132XK-CU	6QP28-132 x 2	—	FUF0525WE-CB	10IJN15-050 x 1	—
FP26132XK-CUI	6QPS28-132 x 2	—	FUF0725WE-CB	10IJN15-070 x 1	—
FP26265J-PU	3PP26-265 x 1	—	FUF0730WE-CB	10IJN25-070 x 1	—
FP26265VH-RS	10DP26-265 x 1	—	FUF1030WE-CB	10IJN25-100 x 1	—
FP26265XK-CU	6QP28-265 x 1	—	FUF103WE-CB	10IJ25-100 x 1	—
FP30142J-PB	3PP30-143 x 1	—	FUF1530WE-CB	10IGN25-150 x 1	—
FP30142J-PBI	3PP30-143 x 1	—	FUF153WE-CB	10IG25-150 x 1	—
FP30142VH-RV	10DP30-143 x 1	—	FUF2030WE-CB	10IGN25-200 x 1	—
FP30142VH-RVI	10DPS30-143 x 1	—	FUF203WE-CB	10IG25-200 x 1	—
FP30142XE-CB	6QP30-143 x 1	—	FUF3030WE-CB	10IGN25-300 x 1	—
FP30142XE-CBI	6QPS30-143 x 1	—	FUF303WE-CB	10IG25-300 x 1	—
FP30295J-PB	3PP30-295 x 1	—	FUF3050WE-CB	10QGN43-300 x 1	—
FP30295J-PBI	3PP30-295 x 1	—	FUF305WE-CB	10QG43-300 x 1	—
FP30295VH-RV	10DP30-295 x 1	—	FUF315WE-CB	10CJ13-030 x 1	—
FP30295VH-RVI	10DPS30-295 x 1	—	FUF31WE-CB	10CJ10-030 x 1	—
FP30295XE-CB	6QP30-295 x 1	—	FUF415WE-CB	10CJ13-044 x 1	—
FP30295XE-CBI	6QPS30-295 x 1	—	FUF425WE-CB	10IJ15-040 x 1	—
FS1357YE-CB	6CJ25-120 x 2	—	FUF525WE-CB	10IJN15-050 x 1	—
FS1358YE-CB	6CJ25-120 x 2	—	FUF53WE-CB	10IJ25-050 x 1	—
FS1359YE-CB	6CJ25-240 x 1	—	FUK0205-AB	AJN08-024 x 1	—
FS1360YE-CB	6CJ25-240 x 1	—	FUK0305-AB	AJN08-030 x 1	—
FS1361YE-CB	6CJ25-240 x 1	—	FUK0310-AB	AJN10-030 x 1	—
FS1362YE-CB	6CJ25-240 x 1	—	FUK0410-AB	AJN10-040 x 1	—

Competitor Part Number	Parker Finite Part Number	Kit Required	Competitor Part Number	Parker Finite Part Number	Kit Required
FUK0420-AB	AJN13-040 x 1	—	FUM53XE-CB	6IJ25-050 x 1	—
FUK0520-AB	AJN13-050 x 1	—	FUS0205YE-CB	4HJN08-024 x 1	—
FUK0525-AB	AJN15-050 x 1	—	FUS0305YE-CB	4HJN08-030 x 1	—
FUK0725-AB	AJN15-070 x 1	—	FUS0310YE-CB	4CJN10-030 x 1	—
FUK0730-AB	AJN25-070 x 1	—	FUS0410YE-CB	4CJN10-040 x 1	—
FUK103-AB	AJ25-100 x 1	—	FUS0420YE-CB	4CJN13-040 x 1	—
FUK1030-AB	AJN25-100 x 1	—	FUS0520YE-CB	4CJN13-050 x 1	—
FUK153-AB	AG25-150 x 1	—	FUS0525YE-CB	4IJN15-050 x 1	—
FUK1530-AB	AGN25-150 x 1	—	FUS0725YE-CB	4IJN15-070 x 1	—
FUK203-AB	AG25-200 x 1	—	FUS0730YE-CB	4IJN25-070 x 1	—
FUK2030-AB	AGN25-200 x 1	—	FUS1030YE-CB	4IJN25-100 x 1	—
FUK303-AB	AG25-300 x 1	—	FUS103YE-CB	4IJ25-100 x 1	—
FUK3030-AB	AGN25-300 x 1	—	FUS1530YE-CB	4IGN25-150 x 1	—
FUK305-AB	AG43-300 x 1	—	FUS153YE-CB	4IG25-150 x 1	—
FUK3050-AB	AGN43-300 x 1	—	FUS2030YE-CB	4IGN25-200 x 1	—
FUK31-AB	AJ10-030 x 1	—	FUS203YE-CB	4IG25-200 x 1	—
FUK315-AB	AJ13-030 x 1	—	FUS3030YE-CB	4IGN25-300 x 1	—
FUK415-AB	AJ13-044 x 1	—	FUS303YE-CB	4IG25-300 x 1	—
FUK425-AB	AJ15-040 x 1	—	FUS3050YE-CB	4QGN43-300 x 1	—
FUK525-AB	AJN15-050 x 1	—	FUS305YE-CB	4QG43-300 x 1	—
FUK53-AB	AJ25-050 x 1	—	FUS315YE-CB	4CJ13-030 x 1	—
FUM0205XE-CB	6HJN08-024 x 1	—	FUS31YE-CB	4CJ10-030 x 1	—
FUM0305XE-CB	6HJN08-030 x 1	—	FUS415YE-CB	4CJ13-044 x 1	—
FUM0310XE-CB	6CJN10-030 x 1	—	FUS425YE-CB	4IJ15-040 x 1	—
FUM0410XE-CB	6CJN10-040 x 1	—	FUS525YE-CB	4IJN15-050 x 1	—
FUM0420XE-CB	6CJN13-040 x 1	—	FUS53YE-CB	4IJ25-050 x 1	—
FUM0520XE-CB	6CJN13-050 x 1	—	FV1500VE-CB	10ICC25-240 x 1	—
FUM0525XE-CB	6IJN15-050 x 1	—	FV1500VE-SBM	10DC25-240 x 1	—
FUM0725XE-CB	6IJN15-070 x 1	—	FV1500VH-SBM	10DC25-240 x 1	—
FUM0730XE-CB	6IJN25-070 x 1	—	FV1500XE-CB	8ICC25-240 x 1	—
FUM1030XE-CB	6IJN25-100 x 1	—	FV1500XE-SBM	8DC25-240 x 1	—
FUM103XE-CB	6IJ25-100 x 1	—	FV1500ZE-CB	6ICC25-240 x 1	—
FUM1530XE-CB	6IGN25-150 x 1	—	FV1500ZE-SBM	6DC25-240 x 1	—
FUM153XE-CB	6IG25-150 x 1	—	FV15XE-CB2	6CC15-150 x 2	—
FUM2030XE-CB	6IGN25-200 x 1	—	FV15ZE-CB2	4CC15-150 x 2	—
FUM203XE-CB	6IG25-200 x 1	—	FV1625VE-CB	10ICC25-300 x 1	—
FUM3030XE-CB	6IGN25-300 x 1	—	FV1625VE-SBM	10DC25-300 x 1	—
FUM303XE-CB	6IG25-300 x 1	—	FV1625VH-SBM	10DC25-300 x 1	—
FUM3050XE-CB	6QGN43-300 x 1	—	FV1625XE-CB	8ICC25-300 x 1	—
FUM3050XE-CB	6QGN43-300 x 1	—	FV1625XE-SBM	8DC25-300 x 1	—
FUM305XE-CB	6QG43-300 x 1	—	FV1625ZE-CB	6ICC25-300 x 1	—
FUM315XE-CB	6CJ13-030 x 1	—	FV1625ZE-SBM	6DC25-300 x 1	—
FUM31XE-CB	6CJ10-030 x 1	—	FV22XE-CB	6ICC25-220 x 1	—
FUM415XE-CB	6CJ13-044 x 1	—	FV22ZE-CB	4ICC25-220 x 1	—
FUM425XE-CB	6IJ15-040 x 1	—	FV860XE-CB	6CC15-060 x 2	—
FUM525XE-CB	6IJN15-050 x 1	—	FV860ZE-CB	4CC15-060 x 2	—

Competitor Part Number	Parker Finite Part Number	Kit Required
FV8XE-CB	6CC15-080 x 2	—
FV8ZE-CB	4CC15-080 x 2	—
FVKE15H-RSA	10DC15-150 x 2	—
FVKE15J-PB	3PC15-150 x 2	—
FVKE22H-RSA	10DC25-220 x 1	—
FVKE22J-PB	3PCC25-220 x 1	—
FVKE6J-PB	3PC15-080 x 2	—
FVKEJ-PB	3PC15-060 x 2	—
FW532-AS	AK15-052 x 4	—
FW534-AB	AK25-238 x 1	—
FW535-AB	AL25-063 x 2	—
FW538-AB	AK35-074 x 2	—
FW540-AB	AL10-024 x 4	—
FW548YE-CB	6HL10-021 x 4	—
FW549YE-CB	6CL10-024 x 4	—
FW550YE-CB	6CU10-052 x 4	—
FW551YE-CS	6CK15-052 x 4	—
FW552YE-CB	6CL25-063 x 2	—
FW553YE-CB	6CK35-074 x 2	—
FW554YE-CB	6CK25-119 x 2	—
FW555YE-CB	6CK25-238 x 1	—
FW556WE-CB	8CK25-119 x 2	—
FW557WE-CB	8CK25-238 x 1	—
FW558-AB	AK25-080 x 2	—
FW559YE-CB	6CK25-080 x 2	—
FW560YE-CBA	6CK35-074 x 2	—
FW561YE-CBA	6CK35-106 x 1	—
FW562YE-CBA	6CK35-172 x 1	—
FW563-ABA	AK35-074 x 2	—
FW564-ABA	AK35-106 x 1	—
FW565-ABA	AK35-172 x 1	—
FW874WE-CBA	8CK35-074 x 2	—
FW875WE-CBA	8CK35-106 x 1	—
FW876WE-CBA	8CK35-172 x 1	—
FW988WE-CB	8HL10-021 x 4	—
FW989WE-CB	8CL10-024 x 4	—
FW992WE-CS	8CK15-052 x 4	—

Filtersoft® (Elements that require kits)

FH7132YE-CB	6CM10-025 x 8	KX-21
FH7133YE-CB	6CM10-050 x 4	KX-22
FH7134YE-CB	6CM15-060 x 4	KX-23
FH7135YE-CB	6CM15-095 x 2	KX-24
FH7136YE-CB	6CM15-185 x 2	KX-25
FH7137YE-CB	6CU25-187 x 1	KX-2

Competitor Part Number	Parker Finite Part Number	Kit Required
FH7138YE-CB	6CU25-187 x 1	KX-2
FH7152-AB	AM10-025 x 8	KX-21
FH7153-AB	AM10-050 x 4	KX-22
FH7154-AB	AM15-060 x 4	KX-23
FH7155-AB	AM15-095 x 2	KX-24
FH7156-AB	AM15-185 x 2	KX-25
FH7157-AB	AU25-187 x 1	KX-2
FH7158-AB	AU25-187 x 1	KX-2
FH7313VE-CB	10CM10-025 x 8	KX-21
FH7314VE-CB	10CM10-050 x 4	KX-22
FH7315VE-CB	10CM15-060 x 4	KX-23
FH7316VE-CB	10CM15-095 x 2	KX-24
FH7317VE-CB	10CM15-185 x 2	KX-25
FH7318VE-CB	10CU25-187 x 1	KX-2

Note: Kits are required for initial conversion only.

Flair

DH006AA	6CF08-026 x 1	—
DH006AC	AF08-026 x 1	—
DH006AO	10CF08-026 x 1	—
DH013AA	6IF10-032 x 1	—
DH013AC	AF10-032 x 1	—
DH013AO	10IF10-032 x 1	—
DH025AA	6IF10-046 x 1	—
DH025AC	AF10-046 x 1	—
DH025AO	10IF10-046 x 1	—
DH040AA	6IF20-063 x 1	—
DH040AC	AF20-063 x 1	—
DH040AO	10IF20-063 x 1	—
DH085AA	6IF20-102 x 1	—
DH085AC	AF20-102 x 1	—
DH085AO	10IF20-102 x 1	—
DH195AA	6IF25-134 x 1	—
DH195AC	AF25-134 x 1	—
DH195AO	10IF25-134 x 1	—
DH295AA	6IF25-254 x 1	—
DH295AC	AF25-254 x 1	—
DH295AO	10IF25-254 x 1	—
DH400AA	6CF35-165 x 1	—
DH400AC	AF35-165 x 1	—
DH400AO	10CF35-165 x 1	—
DH500AA	6CF43-252 x 1	—
DH500AC	AF43-252 x 1	—
DH500AO	10CF43-252 x 1	—
HK71311C	6CH25-260 x 1	—

Competitor Part Number	Parker Finite Part Number	Kit Required	Competitor Part Number	Parker Finite Part Number	Kit Required
HK7319P	10CH25-260 x 1	—	UFPE0410	3PJN10-040 x 1	—
UFAK0205	AJN08-024 x 1	—	UFPE0420	3PJN13-040 x 1	—
UFAK0305	AJN08-030 x 1	—	UFPE0520	3PJN13-050 x 1	—
UFAK0310	AJN10-030 x 1	—	UFPE0525	3PJN15-050 x 1	—
UFAK0410	AJN10-040 x 1	—	UFPE0725	3PJN15-070 x 1	—
UFAK0420	AJN13-040 x 1	—	UFPE0730	3PJN25-070 x 1	—
UFAK0520	AJN13-050 x 1	—	UFPE1030	3PJN25-100 x 1	—
UFAK0525	AJN15-050 x 1	—	UFPE1530	3PGN25-150 x 1	—
UFAK0725	AJN15-070 x 1	—	UFPE2030	3PGN25-200 x 1	—
UFAK0730	AJN25-070 x 1	—	UFPE3030	3PGN25-300 x 1	—
UFAK1030	AJN25-100 x 1	—	UFPE3050	3PGN43-300 x 1	—
UFAK1530	AGN25-150 x 1	—	UFSMF0205	4HJN08-024 x 1	—
UFAK2030	AGN25-200 x1	—	UFSMF0305	4HJN08-030 x 1	—
UFAK3030	AGN25-300 x 1	—	UFSMF0310	4CJN10-030 x1	—
UFAK3050	AGN43-300 x 1	—	UFSMF0410	4CJN10-040 x 1	—
UFFF0205	10HJN08-024 x 1	—	UFSMF0420	4CJN13-040 x 1	—
UFFF0305	10HJN08-030 x 1	—	UFSMF0520	4CJN13-050 x 1	—
UFFF0310	10CJN10-030 x 1	—	UFSMF0525	4IJN15-050 x 1	—
UFFF0410	10CJN10-040 x 1	—	UFSMF0725	4IJN15-070 x 1	—
UFFF0420	10CJN13-040 x 1	—	UFSMF0730	4IJN25-070 x 1	—
UFFF0520	10CJN13-050 x 1	—	UFSMF1030	4IJN25-100 x 1	—
UFFF0525	10IJN15-050 x 1	—	UFSMF1530	4IGN25-150 x 1	—
UFFF0725	10IJN15-070 x 1	—	UFSMF2030	4IGN25-200 x 1	—
UFFF0730	10IJN25-070 x 1	—	UFSMF3030	4IGN25-300 x 1	—
UFFF1030	10IJN25-100 x 1	—	UFSMF3050	4QGN43-300 x 1	—
UFFF1530	10IGN25-150 x 1	—	VCE15	6CC15-150 x 2	—
UFFF2030	10IGN25-200 x 1	—	VCE22	6ICC25-220 x 1	—
UFFF3030	10IGN25-300 x 1	—	VCE8100	6CC15-080 x 2	—
UFFF3050	10QGN43-300 x 1	—	VCE860	6CC15-060 x 2	—
UFMF0205	6HJN08-024 x 1	—	VCXE15	4CC15-150 x 2	—
UFMF0305	6HJN08-030 x 1	—	VCXE22	4ICC25-220 x 1	—
UFMF0310	6CJN10-030 x 1	—	VCXE8100	4CC15-080 x 2	—
UFMF0410	6CJN10-040 x 1	—	VCXE860	4CC15-060 x 2	—
UFMF0420	6CJN13-040 x 1	—	VE111250B	8ICC25-240 x 1	—
UFMF0520	6CJN13-050 x 1	—	VE11125RB	8DC25-240 x 1	—
UFMF0525	6IJN15-050 x 1	—	VE111265B	8ICC25-300 x 1	—
UFMF0725	6IJN15-070 x 1	—	VE111265RB	8DC25-300 x 1	—
UFMF0730	6IJN25-070 x 1	—	VKE15	3PC15-150 x 2	—
UFMF1030	6IJN25-100 x 1	—	VKE15HT	10DC15-150 x 2	—
UFMF1530	6IGN25-150 x 1	—	VKE22	3PCC25-220 x 1	—
UFMF2030	6IGN25-200 x 1	—	VKE22HT	10DC25-220 x 1	—
UFMF3030	6IGN25-300 x 1	—	VKE6100	3PC15-080 x 2	—
UFMF3050	6QGN43-300 x 1	—	VKE660	3PC15-060 x 2	—
UFPE0205	12GJN08-024 x 1	—	Z1050A	AZ12-023 x 1	—
UFPE0305	12GJN08-030 x 1	—	Z1050V	3PZ12-023 x 1	—
UFPE0310	3PJN10-030 x 1	—	Z1050X	6CZ12-023 x 1	—

Competitor Part Number	Parker Finite Part Number	Kit Required
Z1050Y	8CZ12-023 x 1	—
Z1050Z	10CZ12-023 x 1	—
Z1070A	AZ12-029 x 1	—
Z1070V	3PZ12-029 x 1	—
Z1070X	6CZ12-029 x 1	—
Z1070Y	8CZ12-029 x 1	—
Z1070Z	10CZ12-029 x 1	—
Z1140A	AZ12-056 x 1	—
Z1140V	3PZ12-056 x 1	—
Z1140X	6CZ12-056 x 1	—
Z1140Y	8CZ12-056 x 1	—
Z1140Z	10CZ12-056 x 1	—
Z2010A	AZ20-046 x 1	—
Z2010V	3PZ20-046 x 1	—
Z2010X	6CZ20-046 x 1	—
Z2010Y	8CZ20-046 x 1	—
Z2010Z	10CZ20-046 x 1	—
Z2010Z	10CZ20-046 x 1	—
Z2020A	AZ20-086 x 1	—
Z2020A	AZ20-086 x 1	—
Z2020V	3PZ20-086 x 1	—
Z2020V	3PZ20-086 x 1	—
Z2020X	6CZ20-086 x 1	—
Z2020Y	8CZ20-086 x 1	—
Z2020Z	10CZ20-086 x 1	—
Z2030A	AZ20-126 x 1	—
Z2030V	3PZ20-126 x 1	—
Z2030X	6CZ20-126 x 1	—
Z2030Y	8CZ20-126 x 1	—
Z2030Z	10CZ20-126 x 1	—
Z2050A	AZ20-200 x 1	—
Z2050V	3PZ20-200 x 1	—
Z2050X	6CZ20-200 x 1	—
Z2050Y	8CZ20-200 x 1	—
Z2050Z	10CZ20-200 x 1	—
Z3050A	AZ27-200 x 1	—
Z3050V	3PZ27-200 x 1	—
Z3050X	6CZ27-200 x 1	—
Z3050Y	8CZ27-200 x 1	—
Z3050Z	10CZ27-200 x 1	—
Z3075A	AZ27-298 x 1	—
Z3075V	3PZ27-298 x 1	—
Z3075X	6CZ27-298 x 1	—
Z3075Y	8CZ27-298 x 1	—
Z3075Z	10CZ27-298 x 1	—

Competitor Part Number	Parker Finite Part Number	Kit Required
Z5075A	AZ50-298 x 1	—
Z5075V	3PZ50-298 x 1	—
Z5075X	6CZ50-298 x 1	—
Z5075Y	8CZ50-298 x 1	—
Z5075Z	10CZ50-298 x 1	—

Flair (elements that require kits)

HK71312C	6CU25-187 x 1	KX-2
HK7132C	6CM10-025 x 8	KX-21
HK7133C	6CM10-050 x 4	KX-22
HK7134C	6CM15-060 x 4	KX-23
HK7135C	6CM15-095 x 2	KX-24
HK7136C	6CM15-185 x 2	KX-25
HK7137C	6CU25-187 x 1	KX-2
HK7313P	10CM10-025 x 8	KX-21
HK7314P	10CM10-050 x 4	KX-22
HK7315P	10CM15-060 x 4	KX-23
HK7316P	10CM15-095 x 2	KX-24
HK7317P	10CM15-185 x 2	KX-25
HK7318P	10CU25-187 x 1	KX-2

Note: Kits are required for initial conversion only.

Hankison®

Oil Removal

0731-3	10CM10-025 x 8	KX-21
0731-4	10CM10-050 x 4	KX-22
0731-5	10CM15-060 x 4	KX-23
0731-6	10CM15-095 x 2	KX-24
0731-7	10CH19-177 x 1	—
0731-8	10CU25-187 x 1	KX-2
0731-9	10CH25-260 x 1	—

Note: Kits are required for initial conversion only.

Aerolescer

0713-11	6CH25-260 x 1	—
0713-12	6CU25-187 x 1	KX-2
0713-2	6CM10-025 x 8	KX-21
0713-3	6CM10-050 x 4	KX-22
0713-4	6CM15-060 x 4	KX-23
0713-5	6CM15-095 x 2	KX-24
0713-6	6CM15-185 x 2	KX-25
0713-7	6CU25-187 x 1	KX-2
0713-8	6CU25-187 x 1	KX-2
0713-9	6CH25-260 x 1	—

Note: Kits are required for initial conversion only.

Competitor Part Number	Parker Finite Part Number	Kit Required
Hypersorb		
0715-11	AH25-260 x 1	—
0715-2	AM10-025 x 8	KX-21
0715-3	AM10-050 x 4	KX-22
0715-4	AM15-060 x 4	KX-23
0715-5	AM15-095 x 2	KX-24
0715-6	AM15-185 x 2	KX-25
0715-7	AU25-187 x 1	KX-2
0715-8	AU25-187 x 1	KX-2
0715-9	AH25-260 x 1	—

Note: Kits are required for initial conversion only.

Accumax

0740-4	10DH25-260 x 1	—
--------	----------------	---

HF Series Filters

E1-12	AH10-020 X 1	—
E1-16	AH10-036 X 1	—
E1-20	AH10-060 X 1	—
E1-24	AHC16-066 X 1	—
E1-28	AHC16-108 X 1	—
E1-32	AHC19-131 X 1	—
E1-36	AHC19-176 X 1	—
E1-40	AHC25-204 X 1	—
E1-44	AHC25-265 X 1	—
E1-48	AHC25-323 X 1	—
E1-PV	AH25-260 x 1	—
E3-12	4CH10-020 X 1	—
E3-16	4CH10-036 X 1	—
E3-20	4CH10-060 X 1	—
E3-24	4CH16-066 X 1	—
E3-28	4CH16-108 X 1	—
E3-32	4CH19-131 X 1	—
E3-36	4CH19-176 X 1	—
E3-40	4CH25-204 X 1	—
E3-44	4CH25-265 X 1	—
E3-48	4CH25-323 X 1	—
E3-PV	4CH25-260 X 1	—
E5-12	6CH10-020 X 1	—
E5-16	6CH10-036 X 1	—
E5-20	6CH10-060 X 1	—
E5-24	6CH16-066 X 1	—
E5-28	6CH16-108 X 1	—
E5-32	6CH19-131 X 1	—
E5-36	6CH19-176 X 1	—
E5-40	6CH25-204 X 1	—

Competitor Part Number	Parker Finite Part Number	Kit Required
E5-44	6CH25-265 X 1	—
E5-48	6CH25-323 X 1	—
E5-PV	6CH25-260 x 1	—
E7-12	10CH10-020 X 1	—
E7-16	10CH10-036 X 1	—
E7-20	10CH10-060 X 1	—
E7-24	10CH16-066 X 1	—
E7-28	10CH16-108 X 1	—
E7-32	10CH19-131 X 1	—
E7-36	10CH19-176 X 1	—
E7-36-13	10CH19-177 X 1	—
E7-40	10CH25-204 X 1	—
E7-44	10CH25-265 X 1	—
E7-48	10CH25-323 X 1	—
E7-PV	10CH25-260 x 1	—
E9-12	100WS10-020 X 1	—
E9-16	100WS10-036 X 1	—
E9-20	100WS10-060 X 1	—
E9-24	100WS16-066 X 1	—
E9-28	100WS16-108 X 1	—
E9-32	100WS19-131 X 1	—
E9-36	100WS19-176 X 1	—
E9-40	100WS25-204 X 1	—
E9-44	100WS25-265 X 1	—
E9-48	100WS25-323 X 1	—
E9-PV	100WS25-260 X 1	—

Headline

12-32-50C	6H04-013 x 10	—
12-32-50K	6T04-013 x 10	—
12-32-70C	10H04-013 x 10	—
12-32-70K	10T04-013 x 10	—
12-57-50C	6H04-023 x 10	—
12-57-50K	6T04-023 x 10	—
12-57-70C	10H04-023 x 10	—
12-57-70K	10T04-023 x 10	—
25-127-50C	6H10-050 x 4	—
25-127-70C	10H10-050 x 4	—
25-178-50C	6H10-070 x 4	—
25-178-50K	6T10-070 x 10	—
25-178-70C	10H10-070 x 4	—
25-178-70K	10T10-070 x 10	—
25-64-50C	6H10-025 x 8	—
25-64-50K	6T10-025 x 10	—
25-64-70C	10H10-025 x 8	—

Competitor Part Number	Parker Finite Part Number	Kit Required
25-64-70K	10T10-025 x 10	—
38-152-50C	6H15-060 x 4	—
38-152-50K	6T15-060 x 10	—
38-152-70C	10H15-060 x 4	—
38-152-70K	10T15-060 x 10	—
51-230-50C	6H20-090 x 2	—
51-230-50K	6T20-090 x 10	—
51-230-70C	10H20-090 x 2	—
51-230-70K	10T20-090 x 10	—
51-476-50C	6H20-187 x 1	—
51-476-50K	6T20-187 x 10	—
51-476-70C	10H20-187 x 1	—
51-476-70K	10T20-187 x 10	—
51-89-50C	6H20-035 x 4	—
51-89-70C	10H20-035 x 4	—

Henderson

Coalescer (Dryer Pre-filter)

8D20	6CN10-028 x 8	KX-10
8D28	6CN10-038 x 4	KX-11
16D33	6CU19-050 x 2	KX-12
16D50	6CU19-070 x 2	KX-13
16D100	6CU19-130 x 2	KX-14
16D150	6CU19-187 x 1	KX-16
0812-1	6CE63-118 x 1	—

Particulate (Dryer After-Filter 3 Micron)

SB4	3PN10-038 x 4	KX-11
SB12	3PU19-050 x 2	KX-12
245-3	3PE15-050 x 4	—
0812-1	3PE63-118 x 1	—

Particulate (High Temp 450°F Dryer After-Filter 0.9 Micron)

F350 (450 degrees)	10DS19-187 x 1	KX-16H
F350 (350 degrees)	3PS19-187 x 1	KX-16H

*Note: Kits are required for initial conversion only.

Ingersoll Rand

40011355(NL-3)	6C85-250 x 1	—
40011306(NL-4)	6C85-250 x 1	—
40011645(NL-5)	6C85-360 x 1	—
40011777(NL-6)	6C85-360 x 1	—

Note: Physical size of conversion element is significantly smaller than the original element due to type of media used.

Competitor Part Number	Parker Finite Part Number	Kit Required
------------------------	---------------------------	--------------

Johnson Controls

A4000-627	4CL10-024 x 4	—
A4000-604	4CL10-024 x 4	—
A4000-628	4CL10-053 x 4	—
A4000-605	4CL10-053 x 4	—
A4000-629	6CL25-063 x 2	—
A4000-606	6CL25-063 x 2	—

Pall / Pneumatic Products Corp.

Reverse Ultipore

(Coalescing Pre-Filter for Dryer)

GPC-125PF	6QP19-075 x 2	—
GPC-400PF	6QP25-127 x 1	—
MCC-1001SU	6QP19-098 x 2	—
MCC-1002SU	6QP19-198 x 2	—
MCC-1201SU	6QP28-132 x 2	—
MCC-1202SU	6QP28-265 x 1	—
MCC-4463SU	6QP14-051 x 4	—
MCS-1001SU	6QP19-098 x 2	—
MCS-4463SU	6QP14-051 x 4	—
MDC-1001SU	6QP19-098 x 2	—
MDC-1201SU	6QP28-132 x 2	—
MDC-1202SU	6QP28-265 x 1	—
MDC-4463SU	6QP14-051 x 4	—
MDS-1001SU	6QP19-098 x 2	—
MDS-1201SU	6QPS28-132 x 2	—
MDS-4463SU	6QP14-051 x 4	—
OL-5C	6QP14-051 x 4	—
OL-9C	6QP19-098 x 2	—
PCC-1001SU	6QP19-098 x 2	—
PCC-1002SU	6QP19-198 x 2	—
PCC-1003SU	6QP19-298 x 1	—
PCC-1200SU	6QP30-295 x 1	—
PCC-1201SU	6QP28-132 x 2	—
PCC-1202SU	6QP28-265 x 1	—
PCC-350SU	6QP30-143 x 1	—
PCC-4463SU	6QP14-051 x 4	—
PCC-600SU	6QP30-140 x 1	—
PCC-700SU	6QP30-295 x 1	—
PCS-1001SU	6QP19-098 x 2	—
PCS-1002SU	6QP19-198 x 2	—
PCS-350SU	6QPS30-143 x 1	—
PCS-4463SU	6QP14-051 x 4	—
PCS-700SU	6QPS30-295 x 1	—
POC-035SU	6QP14-051 x 4	—

Competitor Part Number	Parker Finite Part Number	Kit Required
POC-060SU	6QP14-051 x 4	—
POC-1001SU	6QP19-098 x 2	—
POC-1201SU	6QP28-132 x 2	—
POC-1200SU	6QP30-295 x 1	—
POC-600SU	6QP30-140 x 1	—
POS-600SU	6QPS30-140 x 1	—
POS-700SU	6QPS30-295 x 1	—
POS-1001SU	6QPS19-098 x 2	—
POS-1201SU	6QPS28-132 x 2	—
PPC-1200SU	6QP30-295 x 1	—
PPC-1201SU	6QP28-132 x 2	—
PPC-1202SU	6QP28-265 x 1	—
PPC-350SU	6QP30-143 x 1	—
PPC-700SU	6QP30-295 x 1	—
PPY-1001SU	6QP19-098 x 2	—
PPY-1002SU	6QP19-198 x 2	—
PPY-1003SU	6QP19-298 x 1	—

Low Temp (225° F) 3 Micron Particulate After-Filter

GPC-175AF	3PP19-075 x 2	—
MCS-4463AF	3PP14-051 x 4	—
MCS-4463EC	3PP14-051 x 4	—
MDC-1001AF	3PP19-098 x 2	—
MDC-1002AF	3PP19-198 x 2	—
MDC-1201AF	3PP26-132 x 2	—
MDC-1202EC	3PP26-265 x 1	—
MDC-4463AF	3PP14-051 x 4	—
PCC-060AF	3PP14-051 x 4	—
PCC-350AF	3PP30-143 x 1	—
PCC-600AF	3PP30-140 x 1	—
PCC-700AF	3PP30-295 x 1	—
PCC-1001AF	3PP19-098 x 2	—
PCC-1002AF	3PP19-198 x 2	—
PCC-1003AF	3PP19-298 x 1	—
PCC-1200AF	3PP30-295 x 1	—
PCC-1201AF	3PP26-132 x 2	—
PCC-1202EC	3PP26-265 x 1	—
PCC-4463AF	3PP14-051 x 4	—
PCS-060AF	3PP14-051 x 4	—
PCS-350AF	3PPS30-143 x 1	—
PCS-700AF	3PPS30-295 x 1	—
PCS-1001AF	3PP19-098 x 2	—
PCS-1002AF	3PP19-198 x 2	—
PCS-1200AF	3PPS30-295 x 1	—
PCS-4463AF	3PP14-051 x 4	—

Competitor Part Number	Parker Finite Part Number	Kit Required
High Temp (425° F) 0.9 Micron Particulate		
MCC-1001HT	10DP19-098 x 2	—
MCC-1002HT	10DP19-198 x 2	—
MCC-1201HT	10DP26-132 x 2	—
MCC-1202HT	10DP26-265 x 1	—
MCS-1001HT	10DPS19-098 x 2	—
MCS-1002HT	10DPS19-198 x 2	—
MDC-1001HT	10DP19-098 x 2	—
MDC-1002HT	10DP19-198 x 2	—
MDC-1201HT	10DP26-132 x 2	—
MDC-1202HT	10DP26-265 x 1	—
MDS-1001HT	10DPS19-098 x 2	—
MDS-1002HT	10DPS19-198 x 2	—
PCC-1001HT	10DP19-098 x 2	—
PCC-1002HT	10DP19-198 x 2	—
PCC-1003HT	10DP19-298 x 1	—
PCC-1200HT	10DP30-295 x 1	—
PCC-1201HT	10DP26-132 x 2	—
PCC-1202HT	10DP26-265 x 1	—
PCC-350HT	10DP30-143 x 1	—
PCC-600HT	10DP30-140 x 1	—
PCC-700HT	10DP30-295 x 1	—
PCS-1001HT	10DPS19-098 x 2	—
PCS-1002HT	10DPS19-198 x 2	—
PCS-1200HT	10DPS30-295 x 1	—
PCS-350HT	10DPS30-143 x 1	—
PCS-700HT	10DPS30-295 x 1	—

Petrosorb Ultipore Carbon Adsorber

MCS-1001CE	AP19-098 x 2	—
MDC-1001CE	AP19-098 x 2	—
MDC-1001CV	AP19-098 x 2	—
MDC-1001SAU	AP19-098 x 2	—
MDC-1002SAU	AP19-198 x 2	—
MDC-1201SAU	AP26-132 x 2	—
MDC-1202SAU	AP26-265 x 1	—
MDC-4463SAU	AP14-051 x 4	—

Natural Gas Coalescing Filter

CC05LGH13B	6IP15-052 x 4	—
CC1LG7A	6CPC20-098 x 1	—

Competitor Part Number	Parker Finite Part Number	Kit Required
CC3LG7A	7CPP20-290 x 1	—
CC3LG02H13	7CRP20-290 x 1	—
CS604LGH13	7CPP42-400 X 1	—

Pioneer

Particulate Filter Elements

EPS30	3PU10-035 X 1	—
EPS40	3PU10-035 X 1	—
EPS100	3PU10-060 X 1	—
EPS100BA	10CU10-060 X 1	—
EPS250D	3PU15-105 X 1	—
EPS425D	3PU20-133 X 1	—
EPS550D	3PU20-195 X 1	—
EPS750D	3PU25-198 X 1	—
EPS1000D	3PU25-245 X 1	—
EPS1300D	3PU25-285 X 1	—
EPS1700D	3PU32-290 X 1	—
EPS2000D	3PU32-350 X 1	—
EPS2600D	3PU52-290 X 1	—
EPS3500D	3PU78-260 X 1	—
EPS5200D	3PU78-370 X 1	—

Coalescing Filter Elements

ECS25	6CU10-035 X 1	—
ECS35	6CU10-035 X 1	—
ECS60	6CU10-060 X 1	—
ECS90/115	6CU15-070 X 1	—
ECS155	6CU15-105 X 1	—
ECS250D	6IU20-133 X 1	—
ECS350D	6IU20-195 X 1	—
ECS450D	6CU25-198 X 1	—
ECS600D	6CU25-245 X 1	—
ECS800D	6CU25-285 X 1	—
ECS1050D	6CU32-290 X 1	—
ECS1250D	6CU32-350 X 1	—
ECS1650D	6QU52-290 X 1	—
ECS2100D	6QU78-260 X 1	—
ECS3100D	6QU78-370 X 1	—

Micro-lescer Filter Elements

EMS20	4CU10-035 X 1	—
EMS25	4CU10-035 X 1	—

Competitor Part Number	Parker Finite Part Number	Kit Required
EMS50	4CU10-060 X 1	—
EMS75/100	4CU15-070 X 1	—
EMS125D	4CU15-105 X 1	—
EMS185D	4IU20-133 X 1	—
EMS260D	4IU20-195 X 1	—
EMS350D	4CU25-198 X 1	—
EMS450D	4CU25-245 X 1	—
EMS600D	4CU25-285 X 1	—
EMS800D	4CU32-290 X 1	—
EMS1000D	4CU32-350 X 1	—
EMS1250D	4QU52-290 X 1	—
EMS1600D	4QU78-260 X 1	—
EMS2500D	4QU78-370 X 1	—

Pneumatech / Atlas Copco

Coalescing Elements

C-025-10	6C10-025 X 8	—
C-050-10	6C10-050 X 4	—
C-060-15	6CU15-060 X 4	—
C-095-15	6CU15-095 X 2	—
C-130-25	6CU25-130 X 1	—
C-187-25	6CU25-187 X 1	—
C-235-25	6CU25-235 X 1	—
C-280-35	6CU35-280 X 1	—
C-280-51	6QU51-280 X 1	—
C-250-85	6QU85-250 X 1	—
C-360-85	6QU85-360 X 1	—
C3-280-51	6QU51-280 X 1 (3 req'd)	—
Q-025-10	6QU10-025 X 8	—
Q-050-10	6QU10-050 X 4	—
Q-060-15	6QU15-060 X 4	—
Q-095-15	6QU15-095 X 2	—
Q-130-25	6QU25-130 X 1	—
Q-187-25	6QU25-187 X 1	—
Q-235-25	6QU25-235 X 1	—
Q-280-35	6QU35-280 X 1	—

Particulate Elements

P-025-10	3PU10-025 X 8	—
P-050-10	3PU10-050 X 4	—
P-060-15	3PU15-060 X 4	—
P-095-15	3PU15-095 X 2	—
P-130-25	3PU25-130 X 1	—
P-187-25	3PU25-187 X 1	—
P-235-25	3PU25-235 X 1	—

Competitor Part Number	Parker Finite Part Number	Kit Required
P-280-35	3PU35-280 X 1	—
P-280-51	3PU51-280 X 1	—
P-250-85	3PU85-250 X 1	—
P-360-85	3PU85-360 X 1	—
P3-280-51	3PU51-280 X 1 (3 req'd)	—

Adsorber Elements

A-025-10	AU10-025 X 8	—
A-050-10	AU10-050 X 4	—
A-060-15	AU15-060 X 4	—
A-095-15	AU15-095 X 2	—
A-130-25	AU25-130 X 1	—
A-187-25	AU25-187 X 1	—
A-235-25	AU25-235 X 1	—
A-280-35	AU35-280 X 1	—
A-280-51	AV51-280 X 1	—
A-250-85	AV85-250 X 1	—
A-360-85	AV85-360 X 1	—
A3-280-51	AV51-280 X 1 (3 req'd)	—

Pure Air**Puretech**

1350	8DU51-100 x 1	KV-22
1351	8DU51-128 x 1	KV-22
1353	8CU145-200 x 1	—

Purelescer

1357	6CJ25-120 x 2	—
1358	6CJ25-120 x 2 (3 req'd)	—
1359	6CJ25-240 x 1 (3 req'd)	—
1360	6CJ25-240 x 1 (4 req'd)	—
1361	6CJ25-240 x 1 (5 req'd)	—
1362	6CJ25-240 x 1 (6 req'd)	—
1367	6CJ25-240 x 1 (7 req'd)	—
1368	6CJ25-240 x 1 (8 req'd)	—
1406	6CN25-080 x 2	—
1407	6CJ25-120 x 2	—
1408	6CJ25-240 x 1	—
1408	6CJ25-240 x 1 (10 req'd)	—

Pureadsorber

1370	AJ25-240 x 1 (3 req'd)	—
1370	AJ25-240 x 1 (5 req'd)	—

Competitor Part Number	Parker Finite Part Number	Kit Required
1372	AJ25-120 x 2	—
1373	AJ25-120 x 2 (3 req'd)	—
1375	AJ25-240 x 1 (4 req'd)	—
1377	AJ25-240 x 1 (6 req'd)	—
1378	AJ25-240 x 1 (7 req'd)	—
1379	AJ25-240 x 1 (8 req'd)	—
1411	AN25-080 x 2	—
1412	AJ25-120 x 2	—
1413	AJ25-240 x 1	—
1418	AJ25-240 x 1 (10 req'd)	—

Note: Closure end cap O-rings are included for all elements.

Note: Kits are required for initial conversion only.

Steris®

129360-802	6G10-025 x 10	—
------------	---------------	---

Sullair®

250024-423	10CF08-026 x 1	—
250024-424	10IF10-032 x 1	—
250024-425	10IF10-046 x 1	—
250024-426	10IF20-063 x 1	—
250024-427	10IF20-102 x 1	—
250024-428	10IF25-134 x 1	—
250024-429	10IF25-254 x 1	—
250030-644	10CF35-165 x 1	—
250024-430	10CF35-251 x 1	—
250024-431	6CF08-026 x 1	—
250024-432	6IF10-032 x 1	—
250024-433	6IF10-046 x 1	—
250024-434	6IF20-063 x 1	—
250024-435	6IF20-102 x 1	—
250024-436	6IF25-134 x 1	—
250024-437	6IF25-254 x 1	—
250024-438	6CF35-251 x 1	—

Ultra Air

EC100P	6CM15-060 x 4	—
--------	---------------	---

Competitor Part Number	Parker Finite Part Number	Kit Required
------------------------	---------------------------	--------------

Ultrafilter / Donaldson®

80 Series

Prefilters

V-PE 3/1	3PJ10-030 x 1	—
V-PE 3/1,5	3PJ13-030 x 1	—
V-PE 4/1,5	3PJ13-044 x 1	—
V-PE 4/2,5	3PJ15-040 x 1	—
V-PE 5/2,5	3PJN15-050 x 1	—
V-PE 5/3	3PJ25-050 x 1	—
V-PE 10/3	3PJ25-100 x 1	—
V-PE 15/3	3PG25-150 x 1	—
V-PE 20/3	3PG25-200 x 1	—
V-PE 30/3	3PG25-300 x 1	—
V-PE 30/5	3PG43-300 x 1	—

Fine Filters

FF 3/1	10CJ10-030 x 1	—
FF 3/1,5	10CJ13-030 x 1	—
FF 4/1,5	10CJ13-044 x 1	—
FF 4/2,5	10IJ15-040 x 1	—
FF 5/2,5	10IJN15-050 x 1	—
FF 5/3	10IJ25-050 x 1	—
FF 10/3	10IJ25-100 x 1	—
FF 15/3	10IG25-150 x 1	—
FF 20/3	10IG25-200 x 1	—
FF 30/3	10IG25-300 x 1	—
FF 30/5	10QG43-300 x 1	—

Micro Filters

MF 3/1	6CJ10-030 x 1	—
MF 3/1,5	6CJ13-030 x 1	—
MF 4/1,5	6CJ13-044 x 1	—
MF 4/2,5	6IJ15-040 x 1	—
MF 5/2,5	6IJN15-050 x 1	—
MF 5/3	6IJ25-050 x 1	—
MF 10/3	6IJ25-100 x 1	—
MF 15/3	6IG25-150 x 1	—
MF 20/3	6IG25-200 x 1	—
MF 30/3	6IG25-300 x 1	—
MF 30/5	6QG43-300 x 1	—

Sub Micro Filters

SMF 3/1	4CJ10-030 x 1	—
SMF 3/1,5	4CJ13-030 x 1	—
SMF 4/1,5	4CJ13-044 x 1	—

Competitor Part Number	Parker Finite Part Number	Kit Required
------------------------	---------------------------	--------------

SMF 4/2,5	4IJ15-040 x 1	—
SMF 5/2,5	4IJN15-050 x 1	—
SMF 5/3	4IJ25-050 x 1	—
SMF 10/3	4IJ25-100 x 1	—
SMF 15/3	4IG25-150 x 1	—
SMF 20/3	4IG25-200 x 1	—
SMF 30/3	4IG25-300 x 1	—
SMF 30/5	4QG43-300 x 1	—

Active Carbon Filters

AK 3/1	AJ10-030 x 1	—
AK 3/1,5	AJ13-030 x 1	—
AK 4/1,5	AJ13-044 x 1	—
AK 4/2,5	AJ15-040 x 1	—
AK 5/2,5	AJN15-050 x 1	—
AK 5/3	AJ25-050 x 1	—
AK 10/3	AJ25-100 x 1	—
AK 15/3	AG25-150 x 1	—
AK 20/3	AG25-200 x 1	—
AK 30/3	AG25-300 x 1	—
AK 30/5	AG43-300 x 1	—

90 Series

Prefilters

PE 02/05	12GJN08-024 x 1	—
PE 03/05	12GJN08-030 x 1	—
PE 03/10	3PJN10-030 x 1	—
PE 04/10	3PJN10-040 x 1	—
PE 04/20	3PJN13-040 x 1	—
PE 05/20	3PJN13-050 x 1	—
PE 05/25	3PJN15-050 x 1	—
PE 07/25	3PJN15-070 x 1	—
PE 07/30	3PJN25-070 x 1	—
PE 10/30	3PJN25-100 x 1	—
PE 15/30	3PGN25-150 x 1	—
PE 20/30	3PGN25-200 x 1	—
PE 30/30	3PGN25-300 x 1	—
PE 30/50	3PGN43-300 x 1	—

Fine Filters

FF 02/05	10HJN08-024 x 1	—
FF 03/05	10HJN08-030 x 1	—
FF 03/10	10CJN10-030 x 1	—
FF 04/10	10CJN10-040 x 1	—
FF 04/20	10CJN13-040 x 1	—
FF 05/20	10CJN13-050 x 1	—

Competitor Part Number	Parker Finite Part Number	Kit Required
FF 05/25	10IJN15-050 x 1	—
FF 07/25	10IJN15-070 x 1	—
FF 07/30	10IJN25-070 x 1	—
FF 10/30	10IJN25-100 x 1	—
FF 15/30	10IGN25-150 x 1	—
FF 20/30	10IGN25-200 x 1	—
FF 30/30	10IGN25-300 x 1	—
FF 30/50	10QGN43-300 x 1	—

Micro Filters

MF 02/05	6HJN08-024 x 1	—
MF 03/05	6HJN08-030 x 1	—
MF 03/10	6CJN10-030 x 1	—
MF 04/10	6CJN10-040 x 1	—
MF 04/20	6CJN13-040 x 1	—
MF 05/20	6CJN13-050 x 1	—
MF 05/25	6IJN15-050 x 1	—
MF 07/25	6IJN15-070 x 1	—
MF 07/30	6IJN25-070 x 1	—
MF 10/30	6IJN25-100 x 1	—
MF 15/30	6IGN25-150 x 1	—
MF 20/30	6IGN25-200 x 1	—
MF 30/30	6IGN25-300 x 1	—
MF 30/50	6QGN43-300 x 1	—

Sub Micro Filters

SMF 02/05	4HJN08-024 x 1	—
SMF 03/05	4HJN08-030 x 1	—
SMF 03/10	4CJN10-030 x 1	—
SMF 04/10	4CJN10-040 x 1	—
SMF 04/20	4CJN13-040 x 1	—
SMF 05/20	4CJN13-050 x 1	—
SMF 05/25	4IJN15-050 x 1	—
SMF 07/25	4IJN15-070 x 1	—
SMF 07/30	4IJN25-070 x 1	—
SMF 10/30	4IJN25-100 x 1	—
SMF 15/30	4IGN25-150 x 1	—
SMF 20/30	4IGN25-200 x 1	—
SMF 30/30	4IGN25-300 x 1	—
SMF 30/50	4QGN43-300 x 1	—

Active Carbon Filters

AK 02/05	AJN08-024 x 1	—
AK 03/05	AJN08-030 x 1	—
AK 03/10	AJN10-030 x 1	—
AK 04/10	AJN10-040 x 1	—

Competitor Part Number	Parker Finite Part Number	Kit Required
AK 04/20	AJN13-040 x 1	—
AK 05/20	AJN13-050 x 1	—
AK 05/25	AJN15-050 x 1	—
AK 07/25	AJN15-070 x 1	—
AK 07/30	AJN25-070 x 1	—
AK 10/30	AJN25-100 x 1	—
AK 15/30	AGN25-150 x 1	—
AK 20/30	AGN25-200 x 1	—
AK 30/30	AGN25-300 x 1	—
AK 30/50	AGN43-300 x 1	—

Process Gas Elements

P-AK 07/30	AGN25-070 X 1	—
P-AK 10-30	AGN25-100 X 1	—
P-FF 07/30	10IJN25-070 X 1	—
P-FF 10/30	10IJN25-100 X 1	—
P-MF 07/30	6IGN25-070 X 1	—
P-MF 10/30	6IGN25-100 X 1	—
P-PE 07/30	3PGN25-070 X 1	—
P-PE 10/30	3PGN25-100 X 1	—
P-SMF 07/30	4IGN25-070 X 1	—
P-SMF 10/30	4IGN25-100 X 1	—

Van Air®

CE-8/60	6CC15-060 x 2	—
CE-8/100	6CC15-080 x 2	—
CE-15	6CC15-150 x 2	—
CE-22/500	6ICC25-220 x 1	—
CXE-8/60	4CC15-060 x 2	—
CXE-8/100	4CC15-080 x 2	—
CXE-15	4CC15-150 x 2	—
CXE-22/350	4ICC25-220 x 1	—
KE-6/60	3PC15-060 x 2	—
KE-6/100	3PC15-080 x 2	—
KE-15	3PC15-150 x 2	—
KE-22	3PCC25-220 x 1	—
KE-15HT	10DC15-150 x 2	—
KE-22HT	10DC25-220 x 1	—

E100 Series

E100-100-B	8CC25-059 x 1	—
E100-100-C	6CC25-059 x 1	—
E100-100-RA	3PC25-059 x 1	—
E100-100-RD	AC25-059 x 1	—

Competitor Part Number	Parker Finite Part Number	Kit Required
E101/102 Series		
E101/102-500-A	10ICC25-240 x 1	—
E101/102-500-B	8ICC25-240 x 1	—
E101/102-500-C	6ICC25-240 x 1	—
E101/102-500-RA	10DC25-240 x 1	—
E101/102-500-RB	8DC25-240 x 1	—
E101/102-500-RC	6DC25-240 x 1	—
E101/102-500-HT	10DC25-240 x 1	—
E101/102-625-A	10ICC25-300 x 1	—
E101/102-625-B	8ICC25-300 x 1	—
E101/102-625-C	6ICC25-300 x 1	—
E101/102-625-RA	10DC25-300 x 1	—
E101/102-625-RB	8DC25-300 x 1	—
E101/102-625-RC	6DC25-300 x 1	—
E101/102-625-RD	AC25-300 x 1	—
E101/102-625-HT	10DC25-300 x 1	—

E200 Series

E200-265-C	6CC25-117 X 1	—
E200-265-B	8CC25-117 X 1	—
E200-265-RD	AC25-117 X 1	—
E200-265-RA	3PC25-117 X 1	—
E200-265-RB	8DC25-117 X 1	—
E200-265-RC	6DC25-117 X 1	—

Zeks®

A18	AZ10-025	—
A50	AZ10-050	—
A80	AZ15-060	—
A100	AZ15-060	—
A140	AZ15-095	—
A200	AZ19-095	—
A300	AZ19-193	—
A400	AZ19-193	—
H130	10DZ15-060	—
H230	10DZ15-095	—
H300	10DZ19-095	—
H450	10DZ19-193	—
H600	10DZ19-193	—
L18	6CZ10-025	—
L50	6CZ10-050	—
L80	6CZ15-060	—
L100	6CZ15-060	—
L140	6CZ15-095	—
L200	6CZ19-095	—

Competitor Part Number	Parker Finite Part Number	Kit Required
L300	6CZ19-193	—
L400	6CZ19-193	—
P30	3PZ10-025	—
P75	3PZ10-050	—
P150	3PZ15-060	—
P275	3PZ15-095	—
P330	3PZ19-095	—
P500	3PZ19-193	—
P670	3PZ19-193	—
R25	10CZ10-025	—
R60	10CZ10-050	—
R80	10CZ10-050	—
R130	10CZ15-060	—
R230	10CZ15-095	—
R300	10CZ19-095	—
R450	10CZ19-193	—
R600	10CZ19-193	—

Zurn® / General Air Dryer**Particulate Filters**

74635-22	12R10-025 x 8	—
74635-24	12RM10-055 x 4	—
74635-26	12R15-060 x 4	—
74635-75	12R20-130 x 2	—
74635-32	12R20-187 x 1	—
74635-40	12RD20-187 x 1	—
74635-90	12RXC20-187 x 1	KV-25
74635-139	3PU51-380 x 1	—

Note: Kits are required for initial conversion only.

Coalescing Filters

74635-21	6N10-025 x 8	—
74635-23	6CM10-055 x 4	—
74635-25	6N15-060 x 4	—
74635-74	6N20-130 x 2	—
74635-31	6N20-187 x 1	—
74635-39	6ND20-187 x 1	—
74635-132	6QU37-381 x 1	—
74635-133	6QU51-380 x 1	—
74635-134	6QU80-380 x 1	—

Competitor Part Number	Parker Finite Part Number	Kit Required
Odorguard		
74635-77	AU10-025 x 8	—
74635-78	AU10-055 x 4	—
74635-80	AU15-060 x 4	—
74635-76	AU20-130 x 2	—
74635-79	AU20-187 x 1	—
74635-50	AD20-187 x 1	—
74635-145	AU51-380 x 1	—
74635-146	AU80-380 x 1	—

Alphanumeric Part Listing by Competitor Part Number

Competitor Part No.	Parker Finite Part No.	Competitor	Kit Req.	Competitor Part No.	Parker Finite Part No.	Competitor	Kit Req.
1350	8DU51-100 x 1	Pure Air	KV-22	0713-2	6CM10-025 x 8	Hankison®	KX-21
1351	8DU51-128 x 1	Pure Air	KV-22	0713-3	6CM10-050 x 4	Hankison®	KX-22
1353	8CU145-200 x 1	Pure Air	—	0713-4	6CM15-060 x 4	Hankison®	KX-23
1357	6CJ25-120 x 2	Pure Air	—	0713-5	6CM15-095 x 2	Hankison®	KX-24
1358	6CJ25-120 x 2 (3 req'd)	Pure Air	—	0713-6	6CM15-185 x 2	Hankison®	KX-25
1359	6CJ25-240 x 1 (3 req'd)	Pure Air	—	0713-7	6CU25-187 x 1	Hankison®	KX-2
1360	6CJ25-240 x 1 (4 req'd)	Pure Air	—	0713-8	6CU25-187 x 1	Hankison®	KX-2
1361	6CJ25-240 x 1 (5 req'd)	Pure Air	—	0713-9	6CH25-260 x 1	Hankison®	—
1362	6CJ25-240 x 1 (6 req'd)	Pure Air	—	0715-11	AH25-260 x 1	Hankison®	—
1367	6CJ25-240 x 1 (7 req'd)	Pure Air	—	0715-2	AM10-025 x 8	Hankison®	KX-21
1368	6CJ25-240 x 1 (8 req'd)	Pure Air	—	0715-3	AM10-050 x 4	Hankison®	KX-22
1370	AJ25-240 x 1 (3 req'd)	Pure Air	—	0715-4	AM15-060 x 4	Hankison®	KX-23
1370	AJ25-240 x 1 (5 req'd)	Pure Air	—	0715-5	AM15-095 x 2	Hankison®	KX-24
1372	AJ25-120 x 2	Pure Air	—	0715-6	AM15-185 x 2	Hankison®	KX-25
1373	AJ25-120 x 2 (3 req'd)	Pure Air	—	0715-7	AU25-187 x 1	Hankison®	KX-2
1375	AJ25-240 x 1 (4 req'd)	Pure Air	—	0715-8	AU25-187 x 1	Hankison®	KX-2
1377	AJ25-240 x 1 (6 req'd)	Pure Air	—	0715-9	AH25-260 x 1	Hankison®	—
1378	AJ25-240 x 1 (7 req'd)	Pure Air	—	0731-3	10CM10-025 x 8	Hankison®	KX-21
1379	AJ25-240 x 1 (8 req'd)	Pure Air	—	0731-4	10CM10-050 x 4	Hankison®	KX-22
1406	6CN25-080 x 2	Pure Air	—	0731-5	10CM15-060 x 4	Hankison®	KX-23
1407	6CJ25-120 x 2	Pure Air	—	0731-6	10CM15-095 x 2	Hankison®	KX-24
1408	6CJ25-240 x 1	Pure Air	—	0731-7	10CH19-177 x 1	Hankison®	—
1408	6CJ25-240 x 1 (10 req'd)	Pure Air	—	0731-8	10CU25-187 x 1	Hankison®	KX-2
1411	AN25-080 x 2	Pure Air	—	0731-9	10CH25-260 x 1	Hankison®	—
1412	AJ25-120 x 2	Pure Air	—	0740-4	10DH25-260 x 1	Hankison®	—
1413	AJ25-240 x 1	Pure Air	—	0812-1	6CE63-118 x 1	Henderson	—
1418	AJ25-240 x 1 (10 req'd)	Pure Air	—	0812-1	3PE63-118 x 1	Henderson	—
0713-11	6CH25-260 x 1	Hankison®	—	10" (80 Series)	6CP15-100 x 2	Cuno® (AMF Cuno)	—
0713-12	6CU25-187 x 1	Hankison®	KX-2	10" (80 Series)	AP15-100 x 2	Cuno® (AMF Cuno)	—
				10" Element	6CP15-100 x 2	Filterite	—
				10" Element	3PP15-100 x 2	Filterite	—

Competitor Part No.	Parker Finite Part No.	Competitor	Kit Req.
10" Element	AP15-100 x 2	Filterite	—
12-32-50C	6H04-013 x 10	Headline	—
12-32-50K	6T04-013 x 10	Headline	—
12-32-70C	10H04-013 x 10	Headline	—
12-32-70K	10T04-013 x 10	Headline	—
12-57-50C	6H04-023 x 10	Headline	—
12-57-50K	6T04-023 x 10	Headline	—
12-57-70C	10H04-023 x 10	Headline	—
12-57-70K	10T04-023 x 10	Headline	—
129360-802	6G10-025 x 10	Steris®	—
16D100	6CU19-130 x 2	Henderson	KX-14
16D150	6CU19-187 x 1	Henderson	KX-16
16D33	6CU19-050 x 2	Henderson	KX-12
16D50	6CU19-070 x 2	Henderson	KX-13
20" Element	6CP15-198 x 2	Filterite	—
20" Element	3PP15-198 x 2	Filterite	—
20" Element	AP15-198 x 2	Filterite	—
245-3	3PE15-050 x 4	Henderson	—
250024-423	10CF08-026 x 1	Sullair®	—
250024-424	10IF10-032 x 1	Sullair®	—
250024-425	10IF10-046 x 1	Sullair®	—
250024-426	10IF20-063 x 1	Sullair®	—
250024-427	10IF20-102 x 1	Sullair®	—
250024-428	10IF25-134 x 1	Sullair®	—
250024-429	10IF25-254 x 1	Sullair®	—
250024-430	10CF35-251 x 1	Sullair®	—
250024-431	6CF08-026 x 1	Sullair®	—
250024-432	6IF10-032 x 1	Sullair®	—
250024-433	6IF10-046 x 1	Sullair®	—
250024-434	6IF20-063 x 1	Sullair®	—
250024-435	6IF20-102 x 1	Sullair®	—
250024-436	6IF25-134 x 1	Sullair®	—
250024-437	6IF25-254 x 1	Sullair®	—
250024-438	6CF35-251 x 1	Sullair®	—
250030-644	10CF35-165 x 1	Sullair®	—
25-127-50C	6H10-050 x 4	Headline	—
25-127-70C	10H10-050 x 4	Headline	—
25-178-50C	6H10-070 x 4	Headline	—
25-178-50K	6T10-070 x 10	Headline	—
25-178-70C	10H10-070 x 4	Headline	—
25-178-70K	10T10-070 x 10	Headline	—
25-64-50C	6H10-025 x 8	Headline	—
25-64-50K	6T10-025 x 10	Headline	—

Competitor Part No.	Parker Finite Part No.	Competitor	Kit Req.
25-64-70C	10H10-025 x 8	Headline	—
25-64-70K	10T10-025 x 10	Headline	—
3-3/4" (30 Series)	6CP15-038 x 4	Cuno® (AMF Cuno)	—
38-152-50C	6H15-060 x 4	Headline	—
38-152-50K	6T15-060 x 10	Headline	—
38-152-70C	10H15-060 x 4	Headline	—
38-152-70K	10T15-060 x 10	Headline	—
40011306(NL-4)	6C85-250 x 1	Ingersoll Rand	—
40011355(NL-3)	6C85-250 x 1	Ingersoll Rand	—
40011645(NL-5)	6C85-360 x 1	Ingersoll Rand	—
40011777(NL-6)	6C85-360 x 1	Ingersoll Rand	—
51-230-50C	6H20-090 x 2	Headline	—
51-230-50K	6T20-090 x 10	Headline	—
51-230-70C	10H20-090 x 2	Headline	—
51-230-70K	10T20-090 x 10	Headline	—
51-476-50C	6H20-187 x 1	Headline	—
51-476-50K	6T20-187 x 10	Headline	—
51-476-70C	10H20-187 x 1	Headline	—
51-476-70K	10T20-187 x 10	Headline	—
51-89-50C	6H20-035 x 4	Headline	—
51-89-70C	10H20-035 x 4	Headline	—
532-221	8CF20-051 x 2	Busch	—
532-302 (532.509.01)	8CF20-099 x 2	Busch	—
532-303 (532.082.01)	8CF20-147 x 1	Busch	—
532-304 (532.507.01)	8CF20-197 x 1	Busch	—
665-88	6CN25-080 x 2	Norgen®	—
74635-132	6QU37-381 x 1	Zurn®/ General Air Dryer	—
74635-133	6QU51-380 x 1	Zurn®/ General Air Dryer	—
74635-134	6QU80-380 x 1	Zurn®/ General Air Dryer	—
74635-139	3PU51-380 x 1	Zurn®/ General Air Dryer	—
74635-145	AU51-380 x 1	Zurn®/ General Air Dryer	—
74635-146	AU80-380 x 1	Zurn®/ General Air Dryer	—
74635-21	6N10-025 x 8	Zurn®/ General Air Dryer	—
74635-22	12R10-025 x 8	Zurn®/ General Air Dryer	—
74635-23	6CM10-055 x 4	Zurn®/ General Air Dryer	—

Competitor Part No.	Parker Finite Part No.	Competitor	Kit Req.
74635-24	12RM10-055 x 4	Zurn®/ General Air Dryer	—
74635-25	6N15-060 x 4	Zurn®/ General Air Dryer	—
74635-26	12R15-060 x 4	Zurn®/ General Air Dryer	—
74635-31	6N20-187 x 1	Zurn®/ General Air Dryer	—
74635-32	12R20-187 x 1	Zurn®/ General Air Dryer	—
74635-39	6ND20-187 x 1	Zurn®/ General Air Dryer	—
74635-40	12RD20-187 x 1	Zurn®/ General Air Dryer	—
74635-50	AD20-187 x 1	Zurn®/ General Air Dryer	—
74635-74	6N20-130 x 2	Zurn®/ General Air Dryer	—
74635-75	12R20-130 x 2	Zurn®/ General Air Dryer	—
74635-76	AU20-130 x 2	Zurn®/ General Air Dryer	—
74635-77	AU10-025 x 8	Zurn®/ General Air Dryer	—
74635-78	AU10-055 x 4	Zurn®/ General Air Dryer	—
74635-79	AU20-187 x 1	Zurn®/ General Air Dryer	—
74635-80	AU15-060 x 4	Zurn®/ General Air Dryer	—
74635-90	12RXC20-187 x 1	Zurn®/ General Air Dryer	KV-25
86-972	6HU20-070 x 2	Binks®	—
86-982	6HU10-050 x 4	Binks®	—
8D20	6CN10-028 x 8	Henderson	KX-10
8D28	6CN10-038 x 4	Henderson	KX-11
9-3/4" (78 Series)	6CP15-098 x 2	Cuno® (AMF Cuno)	—
9-3/4" (78 Series)	AP15-098 x 2	Cuno® (AMF Cuno)	—
A-025-10	AU10-025 X 8	Pneumatech/ Atlas Copco	—
A-050-10	AU10-050 X 4	Pneumatech/ Atlas Copco	—
A-060-15	AU15-060 X 4	Pneumatech/ Atlas Copco	—
A-095-15	AU15-095 X 2	Pneumatech/ Atlas Copco	—
A100	AZ15-060	Zeks	—

Competitor Part No.	Parker Finite Part No.	Competitor	Kit Req.
A-130-25	AU25-130 X 1	Pneumatech/ Atlas Copco	—
A140	AZ15-095	Zeks®	—
A18	AZ10-025	Zeks®	—
A-187-25	AU25-187 X 1	Pneumatech/ Atlas Copco	—
A200	AZ19-095	Zeks®	—
A-235-25	AU25-235 X 1	Pneumatech/ Atlas Copco	—
A-250-85	AV85-250 X 1	Pneumatech/ Atlas Copco	—
A-280-35	AU35-280 X 1	Pneumatech/ Atlas Copco	—
A-280-51	AV51-280 X 1	Pneumatech/ Atlas Copco	—
A300	AZ19-193	Zeks®	—
A3-280-51	AV51-280 X 1 (3 req'd)	Pneumatech/ Atlas Copco	—
A-360-85	AV85-360 X 1	Pneumatech/ Atlas Copco	—
A400	AZ19-193	Zeks®	—
A4000-604	4CL10-024 x 4	Johnson Controls	—
A4000-605	4CL10-053 x 4	Johnson Controls	—
A4000-606	6CL25-063 x 2	Johnson Controls	—
A4000-627	4CL10-024 x 4	Johnson Controls	—
A4000-628	4CL10-053 x 4	Johnson Controls	—
A4000-629	6CL25-063 x 2	Johnson Controls	—
A50	AZ10-050	Zeks®	—
A80	AZ15-060	Zeks®	—
AK 02/05	AJN08-024 x 1	Ultrafilter/ Donaldson®	—
AK 03/05	AJN08-030 x 1	Ultrafilter/ Donaldson®	—
AK 03/10	AJN10-030 x 1	Ultrafilter/ Donaldson®	—
AK 04/10	AJN10-040 x 1	Ultrafilter/ Donaldson®	—
AK 04/20	AJN13-040 x 1	Ultrafilter/ Donaldson®	—
AK 05/20	AJN13-050 x 1	Ultrafilter/ Donaldson®	—
AK 05/25	AJN15-050 x 1	Ultrafilter/ Donaldson®	—
AK 07/25	AJN15-070 x 1	Ultrafilter/ Donaldson®	—

Competitor Part No.	Parker Finite Part No.	Competitor	Kit Req.
AK 07/30	AJN25-070 x 1	Ultrafilter/ Donaldson®	—
AK 10/3	AJ25-100 x 1	Ultrafilter/ Donaldson®	—
AK 10/30	AJN25-100 x 1	Ultrafilter/ Donaldson®	—
AK 15/3	AG25-150 x 1	Ultrafilter/ Donaldson®	—
AK 15/30	AGN25-150 x 1	Ultrafilter/ Donaldson®	—
AK 20/3	AG25-200 x 1	Ultrafilter/ Donaldson®	—
AK 20/30	AGN25-200 x 1	Ultrafilter/ Donaldson®	—
AK 3/1	AJ10-030 x 1	Ultrafilter/ Donaldson®	—
AK 3/1,5	AJ13-030 x 1	Ultrafilter/ Donaldson®	—
AK 30/3	AG25-300 x 1	Ultrafilter/ Donaldson®	—
AK 30/30	AGN25-300 x 1	Ultrafilter/ Donaldson®	—
AK 30/5	AG43-300 x 1	Ultrafilter/ Donaldson®	—
AK 30/50	AGN43-300 x 1	Ultrafilter/ Donaldson®	—
AK 4/1,5	AJ13-044 x 1	Ultrafilter/ Donaldson®	—
AK 4/2,5	AJ15-040 x 1	Ultrafilter/ Donaldson®	—
AK 5/2,5	AJN15-050 x 1	Ultrafilter/ Donaldson®	—
AK 5/3	AJ25-050 x 1	Ultrafilter/ Donaldson®	—
C-025-10	6C10-025 X 8	Pneumatech/ Atlas Copco	—
C-050-10	6C10-050 X 4	Pneumatech/ Atlas Copco	—
C-060-15	6CU15-060 X 4	Pneumatech/ Atlas Copco	—
C-095-15	6CU15-095 X 2	Pneumatech/ Atlas Copco	—
C-130-25	6CU25-130 X 1	Pneumatech/ Atlas Copco	—
C-187-25	6CU25-187 X 1	Pneumatech/ Atlas Copco	—
C-235-25	6CU25-235 X 1	Pneumatech/ Atlas Copco	—
C-250-85	6QU85-250 X 1	Pneumatech/ Atlas Copco	—
C-280-35	6CU35-280 X 1	Pneumatech/ Atlas Copco	—

Competitor Part No.	Parker Finite Part No.	Competitor	Kit Req.
C-280-51	6QU51-280 X 1	Pneumatech/ Atlas Copco	—
C3-280-51	6QU51-280 X 1 (3 req'd)	Pneumatech/ Atlas Copco	—
C-360-85	6QU85-360 X 1	Pneumatech/ Atlas Copco	—
CC05LGH13B	6IP15-052 x 4	Pall/ Pneumat- ic Products Corp.	—
CC1LG7A	6CPC20-098 x 1	Pall/ Pneumat- ic Products Corp.	—
CC3LG02H13	7CRP20-290 x 1	Pall/ Pneumat- ic Products Corp.	—
CC3LG7A	7CPP20-290 x 1	Pall/ Pneumat- ic Products Corp.	—
CE-15	6CC15-150 x 2	Van Air®	—
CE-22/500	6ICC25-220 x 1	Van Air®	—
CE-8/100	6CC15-080 x 2	Van Air®	—
CE-8/60	6CC15-060 x 2	Van Air®	—
CS604LGH13	7CPP42-400 X 1	Pall/ Pneumat- ic Products Corp.	—
CXE-15	4CC15-150 x 2	Van Air®	—
CXE-22/350	4ICC25-220 x 1	Van Air®	—
CXE-8/100	4CC15-080 x 2	Van Air®	—
CXE-8/60	4CC15-060 x 2	Van Air®	—
DH006AA	6CF08-026 x 1	Flair	—
DH006AC	AF08-026 x 1	Flair	—
DH006AO	10CF08-026 x 1	Flair	—
DH013AA	6IF10-032 x 1	Flair	—
DH013AC	AF10-032 x 1	Flair	—
DH013AO	10IF10-032 x 1	Flair	—
DH025AA	6IF10-046 x 1	Flair	—
DH025AC	AF10-046 x 1	Flair	—
DH025AO	10IF10-046 x 1	Flair	—
DH040AA	6IF20-063 x 1	Flair	—
DH040AC	AF20-063 x 1	Flair	—
DH040AO	10IF20-063 x 1	Flair	—
DH085AA	6IF20-102 x 1	Flair	—
DH085AC	AF20-102 x 1	Flair	—
DH085AO	10IF20-102 x 1	Flair	—
DH195AA	6IF25-134 x 1	Flair	—
DH195AC	AF25-134 x 1	Flair	—
DH195AO	10IF25-134 x 1	Flair	—
DH295AA	6IF25-254 x 1	Flair	—
DH295AC	AF25-254 x 1	Flair	—

Competitor Part No.	Parker Finite Part No.	Competitor	Kit Req.
DH295AO	10IF25-254 x 1	Flair	—
DH400AA	6CF35-165 x 1	Flair	—
DH400AC	AF35-165 x 1	Flair	—
DH400AO	10CF35-165 x 1	Flair	—
DH500AA	6CF43-252 x 1	Flair	—
DH500AC	AF43-252 x 1	Flair	—
DH500AO	10CF43-252 x 1	Flair	—
E100-100-B	8CC25-059 x 1	Van Air®	—
E100-100-C	6CC25-059 x 1	Van Air®	—
E100-100-RA	3PC25-059 x 1	Van Air®	—
E100-100-RD	AC25-059 x 1	Van Air®	—
E101/102-500-A	10ICC25-240 x 1	Van Air®	—
E101/102-500-B	8ICC25-240 x 1	Van Air®	—
E101/102-500-C	6ICC25-240 x 1	Van Air®	—
E101/102-500-HT	10DC25-240 x 1	Van Air®	—
E101/102-500-RA	10DC25-240 x 1	Van Air®	—
E101/102-500-RB	8DC25-240 x 1	Van Air®	—
E101/102-500-RC	6DC25-240 x 1	Van Air®	—
E101/102-625-A	10ICC25-300 x 1	Van Air®	—
E101/102-625-B	8ICC25-300 x 1	Van Air®	—
E101/102-625-C	6ICC25-300 x 1	Van Air®	—
E101/102-625-HT	10DC25-300 x 1	Van Air®	—
E101/102-625-RA	10DC25-300 x 1	Van Air®	—
E101/102-625-RB	8DC25-300 x 1	Van Air®	—
E101/102-625-RC	6DC25-300 x 1	Van Air®	—
E101/102-625-RD	AC25-300 x 1	Van Air®	—
E1-12	AH10-020 X 1	Hankison®	—
E1-16	AH10-036 X 1	Hankison®	—
E1-20	AH10-060 X 1	Hankison®	—
E1-24	AHC16-066 X 1	Hankison®	—
E1-28	AHC16-108 X 1	Hankison®	—
E1-32	AHC19-131 X 1	Hankison®	—
E1-36	AHC19-176 X 1	Hankison®	—
E1-40	AHC25-204 X 1	Hankison®	—
E1-44	AHC25-265 X 1	Hankison®	—
E1-48	AHC25-323 X 1	Hankison®	—
E1-PV	AH25-260 x 1	Hankison®	—

Competitor Part No.	Parker Finite Part No.	Competitor	Kit Req.
E200-265-B	8CC25-117 X 1	Van Air®	—
E200-265-C	6CC25-117 X 1	Van Air®	—
E200-265-RA	3PC25-117 X 1	Van Air®	—
E200-265-RB	8DC25-117 X 1	Van Air®	—
E200-265-RC	6DC25-117 X 1	Van Air®	—
E200-265-RD	AC25-117 X 1	Van Air®	—
E3-12	4CH10-020 X 1	Hankison®	—
E3-16	4CH10-036 X 1	Hankison®	—
E3-20	4CH10-060 X 1	Hankison®	—
E3-24	4CH16-066 X 1	Hankison®	—
E3-28	4CH16-108 X 1	Hankison®	—
E3-32	4CH19-131 X 1	Hankison®	—
E3-36	4CH19-176 X 1	Hankison®	—
E3-40	4CH25-204 X 1	Hankison®	—
E3-44	4CH25-265 X 1	Hankison®	—
E3-48	4CH25-323 X 1	Hankison®	—
E3-PV	4CH25-260 X 1	Hankison®	—
E5-12	6CH10-020 X 1	Hankison®	—
E5-16	6CH10-036 X 1	Hankison®	—
E5-20	6CH10-060 X 1	Hankison®	—
E5-24	6CH16-066 X 1	Hankison®	—
E5-28	6CH16-108 X 1	Hankison®	—
E5-32	6CH19-131 X 1	Hankison®	—
E5-36	6CH19-176 X 1	Hankison®	—
E5-40	6CH25-204 X 1	Hankison®	—
E5-44	6CH25-265 X 1	Hankison®	—
E5-48	6CH25-323 X 1	Hankison®	—
E5-PV	6CH25-260 x 1	Hankison®	—
E7-12	10CH10-020 X 1	Hankison®	—
E7-16	10CH10-036 X 1	Hankison®	—
E7-20	10CH10-060 X 1	Hankison®	—
E7-24	10CH16-066 X 1	Hankison®	—
E7-28	10CH16-108 X 1	Hankison®	—
E7-32	10CH19-131 X 1	Hankison®	—
E7-36	10CH19-176 X 1	Hankison®	—
E7-36-13	10CH19-177 X 1	Hankison®	—
E7-40	10CH25-204 X 1	Hankison®	—
E7-44	10CH25-265 X 1	Hankison®	—
E7-48	10CH25-323 X 1	Hankison®	—
E7-PV	10CH25-260 x 1	Hankison®	—
E9-12	100WS10-020 X 1	Hankison®	—
E9-16	100WS10-036 X 1	Hankison®	—
E9-20	100WS10-060 X 1	Hankison®	—

Competitor Part No.	Parker Finite Part No.	Competitor	Kit Req.
E9-24	100WS16-066 X 1	Hankison®	—
E9-28	100WS16-108 X 1	Hankison®	—
E9-32	100WS19-131 X 1	Hankison®	—
E9-36	100WS19-176 X 1	Hankison®	—
E9-40	100WS25-204 X 1	Hankison®	—
E9-44	100WS25-265 X 1	Hankison®	—
E9-48	100WS25-323 X 1	Hankison®	—
E9-PV	100WS25-260 X 1	Hankison®	—
EC100P	6CM15-060 x 4	Ultra Air	—
ECS1050D	6CU32-290 X 1	Pioneer	—
ECS1250D	6CU32-350 X 1	Pioneer	—
ECS155	6CU15-105 X 1	Pioneer	—
ECS1650D	6QU52-290 X 1	Pioneer	—
ECS2100D	6QU78-260 X 1	Pioneer	—
ECS25	6CU10-035 X 1	Pioneer	—
ECS250D	6IU20-133 X 1	Pioneer	—
ECS3100D	6QU78-370 X 1	Pioneer	—
ECS35	6CU10-035 X 1	Pioneer	—
ECS350D	6IU20-195 X 1	Pioneer	—
ECS450D	6CU25-198 X 1	Pioneer	—
ECS60	6CU10-060 X 1	Pioneer	—
ECS600D	6CU25-245 X 1	Pioneer	—
ECS800D	6CU25-285 X 1	Pioneer	—
ECS90/115	6CU15-070 X 1	Pioneer	—
EKF4 x 2	10RU25-281 x 1	Arrow	—
EKF4 x 3	10RU25-281 x 1	Arrow	—
EKF4 x 4	10RU25-281 x 1	Arrow	—
EKF4 x 5	10RU25-281 x 1	Arrow	—
EKF4 x 6	10RU25-281 x 1	Arrow	—
EKF4 x 8	10RU25-281 x 1	Arrow	—
EKF401	10RU07-018 x 8	Arrow	—
EKF402	10RU10-021 x 8	Arrow	—
EKF405	10RA20-040 x 4	Arrow	—
EKF407	10RA20-071 x 2	Arrow	—
EKF408	10RA20-080 x 2	Arrow	—
EKF410	10RU25-101 x 2	Arrow	—
EKF418	10RU25-181 x 1	Arrow	—
EKF428	10RU25-281 x 1	Arrow	—
EKF4N2	10RU25-281 x 1	Arrow	—
EKF5 x 2	6IU25-281 x 1	Arrow	—
EKF5 x 2A	4IU25-281 x 1	Arrow	—
EKF5 x 3	6IU25-281 x 1	Arrow	—

Competitor Part No.	Parker Finite Part No.	Competitor	Kit Req.
EKF5 x 3A	4IU25-281 x 1	Arrow	—
EKF5 x 4	6IU25-281 x 1	Arrow	—
EKF5 x 4A	4IU25-281 x 1	Arrow	—
EKF5 x 5	6IU25-281 x 1	Arrow	—
EKF5 x 5A	4IU25-281 x 1	Arrow	—
EKF5 x 6	6IU25-281 x 1	Arrow	—
EKF5 x 6A	4IU25-281 x 1	Arrow	—
EKF5 x 8	6IU25-281 x 1	Arrow	—
EKF5 x 8A	4IU25-281 x 1	Arrow	—
EKF501	6CU07-018 x 8	Arrow	—
EKF501A	4CU07-018 x 8	Arrow	—
EKF502	6CU10-022 x 8	Arrow	—
EKF502A	4CU10-022 x 8	Arrow	—
EKF505	6IA20-040 x 4	Arrow	—
EKF505A	4IA20-040 x 4	Arrow	—
EKF507	6IA20-071 x 2	Arrow	—
EKF507A	4IA20-071 x 2	Arrow	—
EKF508	6IA20-080 x 2	Arrow	—
EKF508A	4IA20-080 x 2	Arrow	—
EKF510	6IU25-101 x 2	Arrow	—
EKF510A	4IU25-101 x 2	Arrow	—
EKF518	6IU25-181 x 1	Arrow	—
EKF518A	4IU25-181 x 1	Arrow	—
EKF528	6IU25-281 x 1	Arrow	—
EKF528A	4IU25-281 x 1	Arrow	—
EKF529	6CA29-280 x 1	Arrow	—
EKF529A	4CA29-280 x 1	Arrow	—
EKF5N2	6IU25-281 x 1	Arrow	—
EKF5N2A	4IU25-281 x 1	Arrow	—
EKF6 x 2	AU25-281 x 1	Arrow	—
EKF6 x 3	AU25-281 x 1	Arrow	—
EKF6 x 4	AU25-281 x 1	Arrow	—
EKF6 x 5	AU25-281 x 1	Arrow	—
EKF6 x 6	AU25-281 x 1	Arrow	—
EKF6 x 8	AU25-281 x 1	Arrow	—
EKF601	AU07-018 x 8	Arrow	—
EKF602	AU10-022 x 8	Arrow	—
EKF605	AA20-040 x 4	Arrow	—
EKF607	AA20-071 x 2	Arrow	—
EKF608	AA20-080 x 2	Arrow	—
EKF610	AU25-101 x 2	Arrow	—
EKF618	AU25-181 x 1	Arrow	—
EKF628	AU25-281 x 1	Arrow	—
EKF629	AA29-280 x 1	Arrow	—
EKF6N2	AU25-281 x 1	Arrow	—
EMS1000D	4CU32-350 X 1	Pioneer	—

Competitor Part No.	Parker Finite Part No.	Competitor	Kit Req.	Competitor Part No.	Parker Finite Part No.	Competitor	Kit Req.
EMS1250D	4QU52-290 X 1	Pioneer	—	F10020XE-W	6H10-020 x 8	Filtersoft®	—
EMS125D	4CU15-105 X 1	Pioneer	—	F10025VE-T	10G10-025 x 10	Filtersoft®	—
EMS1600D	4QU78-260 X 1	Pioneer	—	F10025VE-W	10H10-025 x 8	Filtersoft®	—
EMS185D	4IU20-133 X 1	Pioneer	—	F10025VH-TB	10T10-025 x 10	Filtersoft®	—
EMS20	4CU10-035 X 1	Pioneer	—	F10025WE-T	8T10-025 x 10	Filtersoft®	—
EMS25	4CU10-035 X 1	Pioneer	—	F10025WE-W	8H10-025 x 8	Filtersoft®	—
EMS2500D	4QU78-370 X 1	Pioneer	—	F10025XE-T	6G10-025 x 10	Filtersoft®	—
EMS260D	4IU20-195 X 1	Pioneer	—	F10025XE-W	6H10-025 x 8	Filtersoft®	—
EMS350D	4CU25-198 X 1	Pioneer	—	F10025XH-TB	6T10-025 x 10	Filtersoft®	—
EMS450D	4CU25-245 X 1	Pioneer	—	F10050VE-W	10H10-050 x 4	Filtersoft®	—
EMS50	4CU10-060 X 1	Pioneer	—	F10050WE-W	8H10-050 x 4	Filtersoft®	—
EMS600D	4CU25-285 X 1	Pioneer	—	F10050XE-W	6H10-050 x 4	Filtersoft®	—
EMS75/100	4CU15-070 X 1	Pioneer	—	F10070VE-T	10G10-070 x 10	Filtersoft®	—
EMS800D	4CU32-290 X 1	Pioneer	—	F10070VE-W	10H10-070 x 4	Filtersoft®	—
EPS100	3PU10-060 X 1	Pioneer	—	F10070VH-TB	10T10-070 x 10	Filtersoft®	—
EPS1000D	3PU25-245 X 1	Pioneer	—	F10070WE-T	8T10-070 x 10	Filtersoft®	—
EPS100BA	10CU10-060 X 1	Pioneer	—	F10070WE-W	8H10-070 x 4	Filtersoft®	—
EPS1300D	3PU25-285 X 1	Pioneer	—	F10070XE-T	6G10-070 x 10	Filtersoft®	—
EPS1700D	3PU32-290 X 1	Pioneer	—	F10070XE-W	6H10-070 x 4	Filtersoft®	—
EPS2000D	3PU32-350 X 1	Pioneer	—	F10070XH-TB	6T10-070 x 10	Filtersoft®	—
EPS250D	3PU15-105 X 1	Pioneer	—	F15043QE-CU	14JU15-043 x 10	Filtersoft®	—
EPS2600D	3PU52-290 X 1	Pioneer	—	F15060AU	AB15-060 x 4	Filtersoft®	—
EPS30	3PU10-035 X 1	Pioneer	—	F15060AU	AU15-060 x 4	Filtersoft®	—
EPS3500D	3PU78-260 X 1	Pioneer	—	F15060VE-T	10G15-060 x 10	Filtersoft®	—
EPS40	3PU10-035 X 1	Pioneer	—	F15060VE-W	10H15-060 x 4	Filtersoft®	—
EPS425D	3PU20-133 X 1	Pioneer	—	F15060WE-W	8H15-060 x 4	Filtersoft®	—
EPS5200D	3PU78-370 X 1	Pioneer	—	F15060XE-T	6G15-060 x 10	Filtersoft®	—
EPS550D	3PU20-195 X 1	Pioneer	—	F15060XE-W	6H15-060 x 4	Filtersoft®	—
EPS750D	3PU25-198 X 1	Pioneer	—	F20035VE-W	10H20-035 x 4	Filtersoft®	—
F05013VE-T	10G04-013 x 10	Filtersoft®	—	F20035WE-W	8H20-035 x 4	Filtersoft®	—
F05013VE-W	10H04-013 x 10	Filtersoft®	—	F20035XE-W	6H20-035 x 4	Filtersoft®	—
F05013WE-T	8T04-013 x 10	Filtersoft®	—	F20090AU	AB15-084 x 2	Filtersoft®	—
F05013WE-W	8H04-013 x 10	Filtersoft®	—	F20090VE-T	10G20-090 x 10	Filtersoft®	—
F05013XE-T	6G04-013 x 10	Filtersoft®	—	F20090VE-W	10H20-090 x 2	Filtersoft®	—
F05013XE-W	6H04-013 x 10	Filtersoft®	—	F20090WE-W	8H20-090 x 2	Filtersoft®	—
F05023VE-T	10G04-023 x 10	Filtersoft®	—	F20090XE-T	6G20-090 x 10	Filtersoft®	—
F05023VE-W	10H04-023 x 10	Filtersoft®	—	F20090XE-W	6H20-090 x 2	Filtersoft®	—
F05023VH-TB	10T04-023 x 10	Filtersoft®	—	F20187AU	AP15-180 x 2	Filtersoft®	—
F05023WE-T	8T04-023 x 10	Filtersoft®	—	F20187VE-T	10G20-187 x 10	Filtersoft®	—
F05023WE-W	8H04-023 x 10	Filtersoft®	—	F20187VE-W	10H20-187 x 1	Filtersoft®	—
F05023XE-T	6G04-023 x 10	Filtersoft®	—	F20187WE-W	8H20-187 x 1	Filtersoft®	—
F05023XE-W	6H04-023 x 10	Filtersoft®	—	F20187XE-T	6G20-187 x 10	Filtersoft®	—
F05023XH-TB	6T04-023 x 10	Filtersoft®	—	F20187XE-W	6H20-187 x 1	Filtersoft®	—
F07013QE-CU	14JU07-013 x 10	Filtersoft®	—	F20198AU	AP15-198 x 2	Filtersoft®	—
F10020QE-CU	14JU10-020 x 10	Filtersoft®	—	F26075QE-CU	14JU26-075 x 4	Filtersoft®	—
F10020VE-W	10H10-020 x 8	Filtersoft®	—	F26120QE-CU	14JU26-120 x 4	Filtersoft®	—

Competitor Part No.	Parker Finite Part No.	Competitor	Kit Req.
F26240QE-CU	14JU26-240 x 4	Filtersoft®	—
F350 (350 de-grees)	3PS19-187 x 1	Henderson	KX-16H
F350 (450 de-grees)	10DS19-187 x 1	Henderson	KX-16H
FA1030AP-AB	AZ07-020 x 1	Filtersoft®	—
FA1030K-CB	3PZ07-020 x 1	Filtersoft®	—
FA1030WE-CB	10CZ07-020 x 1	Filtersoft®	—
FA1030XE-CB	8CZ07-020 x 1	Filtersoft®	—
FA1030YE-CB	6CZ07-020 x 1	Filtersoft®	—
FA1050AP-AB	AZ12-023 x 1	Filtersoft®	—
FA1050K-CB	3PZ12-023 x 1	Filtersoft®	—
FA1050WE-CB	10CZ12-023 x 1	Filtersoft®	—
FA1050XE-CB	8CZ12-023 x 1	Filtersoft®	—
FA1050YE-CB	6CZ12-023 x 1	Filtersoft®	—
FA1070AP-AB	AZ12-029 x 1	Filtersoft®	—
FA1070K-CB	3PZ12-029 x 1	Filtersoft®	—
FA1070WE-CB	10CZ12-029 x 1	Filtersoft®	—
FA1070XE-CB	8CZ12-029 x 1	Filtersoft®	—
FA1070YE-CB	6CZ12-029 x 1	Filtersoft®	—
FA1140AP-AB	AZ12-056 x 1	Filtersoft®	—
FA1140K-CB	3PZ12-056 x 1	Filtersoft®	—
FA1140WE-CB	10CZ12-056 x 1	Filtersoft®	—
FA1140XE-CB	8CZ12-056 x 1	Filtersoft®	—
FA1140YE-CB	6CZ12-056 x 1	Filtersoft®	—
FA2010AP-AB	AZ20-046 x 1	Filtersoft®	—
FA2010K-CB	3PZ20-046 x 1	Filtersoft®	—
FA2010WE-CB	10CZ20-046 x 1	Filtersoft®	—
FA2010XE-CB	8CZ20-046 x 1	Filtersoft®	—
FA2010YE-CB	6CZ20-046 x 1	Filtersoft®	—
FA2020AP-AB	AZ20-086 x 1	Filtersoft®	—
FA2020K-CB	3PZ20-086 x 1	Filtersoft®	—
FA2020WE-CB	10CZ20-086 x 1	Filtersoft®	—
FA2020XE-CB	8CZ20-086 x 1	Filtersoft®	—
FA2020YE-CB	6CZ20-086 x 1	Filtersoft®	—
FA2030AP-AB	AZ20-126 x 1	Filtersoft®	—
FA2030K-CB	3PZ20-126 x 1	Filtersoft®	—
FA2030WE-CB	10CZ20-126 x 1	Filtersoft®	—
FA2030XE-CB	8CZ20-126 x 1	Filtersoft®	—
FA2030YE-CB	6CZ20-126 x 1	Filtersoft®	—
FA2050AP-AB	AZ20-200 x 1	Filtersoft®	—
FA2050K-CB	3PZ20-200 x 1	Filtersoft®	—
FA2050WE-CB	10CZ20-200 x 1	Filtersoft®	—
FA2050XE-CB	8CZ20-200 x 1	Filtersoft®	—
FA2050YE-CB	6CZ20-200 x 1	Filtersoft®	—
FA3050AP-AB	AZ27-200 x 1	Filtersoft®	—

Competitor Part No.	Parker Finite Part No.	Competitor	Kit Req.
FA3050K-CB	3PZ27-200 x 1	Filtersoft®	—
FA3050WE-CB	10CZ27-200 x 1	Filtersoft®	—
FA3050XE-CB	8CZ27-200 x 1	Filtersoft®	—
FA3050YE-CB	6CZ27-200 x 1	Filtersoft®	—
FA3075AP-AB	AZ27-298 x 1	Filtersoft®	—
FA3075K-CB	3PZ27-298 x 1	Filtersoft®	—
FA3075WE-CB	10CZ27-298 x 1	Filtersoft®	—
FA3075XE-CB	8CZ27-298 x 1	Filtersoft®	—
FA3075YE-CB	6CZ27-298 x 1	Filtersoft®	—
FA5075AP-AB	AZ50-298 x 1	Filtersoft®	—
FA5075K-CB	3PZ50-298 x 1	Filtersoft®	—
FA5075WE-CB	10CZ50-298 x 1	Filtersoft®	—
FA5075XE-CB	8CZ50-298 x 1	Filtersoft®	—
FA5075YE-CB	6CZ50-298 x 1	Filtersoft®	—
FB302VE-CB	8CF20-099 x 2	Filtersoft®	—
FB303VE-CB	8CF20-147 x 1	Filtersoft®	—
FB304VE-CB	8CF20-197 x 1	Filtersoft®	—
FE006AAYE-CB	6CF08-026 x 1	Filtersoft®	—
FE006AOVE-CBM	10CF08-026 x 1	Filtersoft®	—
FE013AAYE-CB	6IF10-032 x 1	Filtersoft®	—
FE013AOVE-CBM	10IF10-032 x 1	Filtersoft®	—
FE025AAYE-CB	6IF10-046 x 1	Filtersoft®	—
FE025AOVE-CBM	10IF10-046 x 1	Filtersoft®	—
FE040AAYE-CB	6IF20-063 x 1	Filtersoft®	—
FE040AOVE-CBM	10IF20-063 x 1	Filtersoft®	—
FE085AAYE-CB	6IF20-102 x 1	Filtersoft®	—
FE085AOVE-CBM	10IF20-102 x 1	Filtersoft®	—
FE195AAYE-CB	6IF25-134 x 1	Filtersoft®	—
FE195AC-AB	AF25-134 x 1	Filtersoft®	—
FE195AOVE-CBM	10IF25-134 x 1	Filtersoft®	—
FE295AAYE-CB	6IF25-254 x 1	Filtersoft®	—
FE295AC-AB	AF25-254 x 1	Filtersoft®	—
FE295AOVE-CBM	10IF25-254 x 1	Filtersoft®	—
FE400AAYE-CB	6CF35-165 x 1	Filtersoft®	—
FE400AC-AB	AF35-165 x 1	Filtersoft®	—
FE400AOVE-CBM	10CF35-165 x 1	Filtersoft®	—
FE500AAYE-CB	6CF43-252 x 1	Filtersoft®	—
FE500AC-AB	AF43-252 x 1	Filtersoft®	—
FE500AOVE-CBM	10CF43-252 x 1	Filtersoft®	—

Competitor Part No.	Parker Finite Part No.	Competitor	Kit Req.
FF 02/05	10HJN08-024 x 1	Ultrafilter/ Donaldson®	—
FF 03/05	10HJN08-030 x 1		—
FF 03/10	10CJN10-030 x 1		—
FF 04/10	10CJN10-040 x 1		—
FF 04/20	10CJN13-040 x 1		—
FF 05/20	10CJN13-050 x 1		—
FF 05/25	10IJN15-050 x 1		—
FF 07/25	10IJN15-070 x 1		—
FF 07/30	10IJN25-070 x 1		—
FF 10/3	10IJ25-100 x 1		—
FF 10/30	10IJN25-100 x 1		—
FF 15/3	10IG25-150 x 1		—
FF 15/30	10IGN25-150 x 1		—
FF 20/3	10IG25-200 x 1		—
FF 20/30	10IGN25-200 x 1		—
FF 3/1	10CJ10-030 x 1		—
FF 3/1,5	10CJ13-030 x 1		—
FF 30/3	10IG25-300 x 1		—
FF 30/30	10IGN25-300 x 1		—
FF 30/5	10QG43-300 x 1		—
FF 30/50	10QGN43-300 x 1		—
FF 4/1,5	10CJ13-044 x 1		—
FF 4/2,5	10IJ15-040 x 1		—
FF 5/2,5	10IJN15-050 x 1		—
FF 5/3	10IJ25-050 x 1		—
FH71311YE-CB	6CH25-260 x 1	Filtersoft®	—
FH7132YE-CB	6CM10-025 x 8	Filtersoft® (Elements that require kits)	KX- 21
FH7133YE-CB	6CM10-050 x 4	Filtersoft® (Elements that require kits)	KX- 22
FH7134YE-CB	6CM15-060 x 4	Filtersoft® (Elements that require kits)	KX- 23
FH7135YE-CB	6CM15-095 x 2	Filtersoft® (Elements that require kits)	KX- 24
FH7136YE-CB	6CM15-185 x 2	Filtersoft® (Elements that require kits)	KX- 25
FH7137YE-CB	6CU25-187 x 1	Filtersoft® (Elements that require kits)	KX-2
FH7138YE-CB	6CU25-187 x 1	Filtersoft (Elements that require kits)	KX-2
FH7139YE-CB	6CH25-260 x 1	Filtersoft®	—

Competitor Part No.	Parker Finite Part No.	Competitor	Kit Req.
FH71511-AB	AH25-260 x 1	Filtersoft®	—
FH7152-AB	AM10-025 x 8	Filtersoft® (Elements that require kits)	KX- 21
FH7153-AB	AM10-050 x 4	Filtersoft® (Elements that require kits)	KX- 22
FH7154-AB	AM15-060 x 4	Filtersoft (Elements that require kits)	KX- 23
FH7155-AB	AM15-095 x 2	Filtersoft® (Elements that require kits)	KX- 24
FH7156-AB	AM15-185 x 2	Filtersoft® (Elements that require kits)	KX- 25
FH7157-AB	AU25-187 x 1	Filtersoft® (Elements that require kits)	KX-2
FH7158-AB	AU25-187 x 1	Filtersoft® (Elements that require kits)	KX-2
FH7159-AB	AH25-260 x 1	Filtersoft®	—
FH7313VE-CB	10CM10-025 x 8	Filtersoft® (Elements that require kits)	KX- 21
FH7314VE-CB	10CM10-050 x 4	Filtersoft® (Elements that require kits)	KX- 22
FH7315VE-CB	10CM15-060 x 4	Filtersoft® (Elements that require kits)	KX- 23
FH7316VE-CB	10CM15-095 x 2	Filtersoft® (Elements that require kits)	KX- 24
FH7317VE-CB	10CM15-185 x 2	Filtersoft® (Elements that require kits)	KX- 25
FH7318VE-CB	10CU25-187 x 1	Filtersoft® (Elements that require kits)	KX-2
FH7319VE-CB	10CH25-260 x 1	Filtersoft®	—
FI1306XE-C	6C85-250 x 1	Filtersoft®	—
FI1355XE-C	6C85-250 x 1	Filtersoft®	—
FI1645XE-C	6C85-360 x 1	Filtersoft®	—
FI1777XE-C	6C85-360 x 1	Filtersoft®	—
FP14051J-PB	3PP14-051 x 4	Filtersoft®	—
FP14051XE-CB	6QP14-051 x 4	Filtersoft®	—
FP19098J-PU	3PP19-098 x 2	Filtersoft®	—
FP19098VH-RS	10DP19-098 x 2	Filtersoft®	—
FP19098VH-RSI	10DPS19-098 x 2	Filtersoft®	—
FP19098XE-CU	6QP19-098 x 2	Filtersoft®	—

Competitor Part No.	Parker Finite Part No.	Competitor	Kit Req.
FP19098XE-DB	6QP19-098 x 2	Filtersoft®	—
FP19098XK-CB	6QP19-098 x 2	Filtersoft®	—
FP19198J-PU	3PP19-198 x 2	Filtersoft®	—
FP19198VH-RS	10DP19-198 x 2	Filtersoft®	—
FP19198VH-RSI	10DPS19-198 x 2	Filtersoft®	—
FP19198XE-CU	6QP19-198 x 2	Filtersoft®	—
FP19198XE-DB	6QP19-198 x 2	Filtersoft®	—
FP19298XE-CU	6QP19-298 x 1	Filtersoft®	—
FP19298XE-DB	6QP19-298 x 1	Filtersoft®	—
FP26132J-PU	3PP26-132 x 2	Filtersoft®	—
FP26132VH-RS	10DP26-132 x 2	Filtersoft®	—
FP26132XK-CBI	6QP28-132 x 2	Filtersoft®	—
FP26132XK-CU	6QP28-132 x 2	Filtersoft®	—
FP26132XK-CUI	6QPS28-132 x 2	Filtersoft®	—
FP26265J-PU	3PP26-265 x 1	Filtersoft®	—
FP26265VH-RS	10DP26-265 x 1	Filtersoft®	—
FP26265XK-CU	6QP28-265 x 1	Filtersoft®	—
FP30142J-PB	3PP30-143 x 1	Filtersoft®	—
FP30142J-PBI	3PP30-143 x 1	Filtersoft®	—
FP30142VH-RV	10DP30-143 x 1	Filtersoft®	—
FP30142VH-RVI	10DPS30-143 x 1	Filtersoft®	—
FP30142XE-CB	6QP30-143 x 1	Filtersoft®	—
FP30142XE-CBI	6QPS30-143 x 1	Filtersoft®	—
FP30295J-PB	3PP30-295 x 1	Filtersoft®	—
FP30295J-PBI	3PP30-295 x 1	Filtersoft®	—
FP30295VH-RV	10DP30-295 x 1	Filtersoft®	—
FP30295VH-RVI	10DPS30-295 x 1	Filtersoft®	—
FP30295XE-CB	6QP30-295 x 1	Filtersoft®	—
FP30295XE-CBI	6QPS30-295 x 1	Filtersoft®	—
FS1357YE-CB	6CJ25-120 x 2	Filtersoft®	—
FS1358YE-CB	6CJ25-120 x 2	Filtersoft®	—
FS1359YE-CB	6CJ25-240 x 1	Filtersoft®	—
FS1360YE-CB	6CJ25-240 x 1	Filtersoft®	—
FS1361YE-CB	6CJ25-240 x 1	Filtersoft®	—
FS1362YE-CB	6CJ25-240 x 1	Filtersoft®	—
FS1367YE-CB	6CJ25-240 x 1	Filtersoft®	—
FS1368YE-CB	6CJ25-240 x 1	Filtersoft®	—
FS1370-AB	AJ25-240 x 1	Filtersoft®	—
FS1372-AB	AJ25-120 x 2	Filtersoft®	—
FS1373-AB	AJ25-120 x 2	Filtersoft®	—
FS1375-AB	AJ25-240 x 1	Filtersoft®	—
FS1377-AB	AJ25-240 x 1	Filtersoft®	—
FS1378-AB	AJ25-240 x 1	Filtersoft®	—

Competitor Part No.	Parker Finite Part No.	Competitor	Kit Req.
FS1379-AB	AJ25-240 x 1	Filtersoft®	—
FS1407YE-CB	6CJ25-120 x 2	Filtersoft®	—
FS1408YE-CB	6CJ25-240 x 1	Filtersoft®	—
FS1412-AB	AJ25-120 x 2	Filtersoft®	—
FS1413-AB	AJ25-240 x 1	Filtersoft®	—
FS1413YE-CB	6CJ25-240 x 1	Filtersoft®	—
FS1418-AB	AJ25-240 x 1	Filtersoft®	—
FS5025-AB	AJ25-240 x 1	Filtersoft®	—
FS5027-AB	AJ25-240 x 1	Filtersoft®	—
FUF-0205WE-CB	10HJN08-024 x 1	Filtersoft®	—
FUF-0305WE-CB	10HJN08-030 x 1	Filtersoft®	—
FUF-0310WE-CB	10CJN10-030 x 1	Filtersoft®	—
FUF-0410WE-CB	10CJN10-040 x 1	Filtersoft®	—
FUF-0420WE-CB	10CJN13-040 x 1	Filtersoft®	—
FUF-0520WE-CB	10CJN13-050 x 1	Filtersoft®	—
FUF-0525WE-CB	10IJN15-050 x 1	Filtersoft®	—
FUF-0725WE-CB	10IJN15-070 x 1	Filtersoft®	—
FUF-0730WE-CB	10IJN25-070 x 1	Filtersoft®	—
FUF-1030WE-CB	10IJN25-100 x 1	Filtersoft®	—
FUF103WE-CB	10IJ25-100 x 1	Filtersoft®	—
FUF-1530WE-CB	10IGN25-150 x 1	Filtersoft®	—
FUF153WE-CB	10IG25-150 x 1	Filtersoft®	—
FUF-2030WE-CB	10IGN25-200 x 1	Filtersoft®	—
FUF203WE-CB	10IG25-200 x 1	Filtersoft®	—
FUF-3030WE-CB	10IGN25-300 x 1	Filtersoft®	—
FUF303WE-CB	10IG25-300 x 1	Filtersoft®	—
FUF-3050WE-CB	10QGN43-300 x 1	Filtersoft®	—
FUF305WE-CB	10QG43-300 x 1	Filtersoft®	—
FUF315WE-CB	10CJ13-030 x 1	Filtersoft®	—
FUF31WE-CB	10CJ10-030 x 1	Filtersoft®	—
FUF415WE-CB	10CJ13-044 x 1	Filtersoft®	—
FUF425WE-CB	10IJ15-040 x 1	Filtersoft®	—
FUF525WE-CB	10IJN15-050 x 1	Filtersoft®	—
FUF53WE-CB	10IJ25-050 x 1	Filtersoft®	—
FUK0205-AB	AJN08-024 x 1	Filtersoft®	—

Competitor Part No.	Parker Finite Part No.	Competitor	Kit Req.
FUK0305-AB	AJN08-030 x 1	Filtersoft®	—
FUK0310-AB	AJN10-030 x 1	Filtersoft®	—
FUK0410-AB	AJN10-040 x 1	Filtersoft®	—
FUK0420-AB	AJN13-040 x 1	Filtersoft®	—
FUK0520-AB	AJN13-050 x 1	Filtersoft®	—
FUK0525-AB	AJN15-050 x 1	Filtersoft®	—
FUK0725-AB	AJN15-070 x 1	Filtersoft®	—
FUK0730-AB	AJN25-070 x 1	Filtersoft®	—
FUK1030-AB	AJN25-100 x 1	Filtersoft®	—
FUK103-AB	AJ25-100 x 1	Filtersoft®	—
FUK1530-AB	AGN25-150 x 1	Filtersoft®	—
FUK153-AB	AG25-150 x 1	Filtersoft®	—
FUK2030-AB	AGN25-200 x 1	Filtersoft®	—
FUK203-AB	AG25-200 x 1	Filtersoft®	—
FUK3030-AB	AGN25-300 x 1	Filtersoft®	—
FUK303-AB	AG25-300 x 1	Filtersoft®	—
FUK3050-AB	AGN43-300 x 1	Filtersoft®	—
FUK305-AB	AG43-300 x 1	Filtersoft®	—
FUK315-AB	AJ13-030 x 1	Filtersoft®	—
FUK31-AB	AJ10-030 x 1	Filtersoft®	—
FUK415-AB	AJ13-044 x 1	Filtersoft®	—
FUK425-AB	AJ15-040 x 1	Filtersoft®	—
FUK525-AB	AJN15-050 x 1	Filtersoft®	—
FUK53-AB	AJ25-050 x 1	Filtersoft®	—
FUM0205XE-CB	6HJN08-024 x 1	Filtersoft®	—
FUM0305XE-CB	6HJN08-030 x 1	Filtersoft®	—
FUM0310XE-CB	6CJN10-030 x 1	Filtersoft®	—
FUM0410XE-CB	6CJN10-040 x 1	Filtersoft®	—
FUM0420XE-CB	6CJN13-040 x 1	Filtersoft®	—
FUM0520XE-CB	6CJN13-050 x 1	Filtersoft®	—
FUM0525XE-CB	6IJN15-050 x 1	Filtersoft®	—
FUM0725XE-CB	6IJN15-070 x 1	Filtersoft®	—
FUM0730XE-CB	6IJN25-070 x 1	Filtersoft®	—
FUM1030XE-CB	6IJN25-100 x 1	Filtersoft®	—
FUM103XE-CB	6IJ25-100 x 1	Filtersoft®	—
FUM1530XE-CB	6IGN25-150 x 1	Filtersoft®	—
FUM153XE-CB	6IG25-150 x 1	Filtersoft®	—

Competitor Part No.	Parker Finite Part No.	Competitor	Kit Req.
FUM2030XE-CB	6IGN25-200 x 1	Filtersoft®	—
FUM203XE-CB	6IG25-200 x 1	Filtersoft®	—
FUM3030XE-CB	6IGN25-300 x 1	Filtersoft®	—
FUM303XE-CB	6IG25-300 x 1	Filtersoft®	—
FUM3050XE-CB	6QGN43-300 x 1	Filtersoft®	—
FUM3050XE-CB	6QGN43-300 x 1	Filtersoft®	—
FUM305XE-CB	6QG43-300 x 1	Filtersoft®	—
FUM315XE-CB	6CJ13-030 x 1	Filtersoft®	—
FUM31XE-CB	6CJ10-030 x 1	Filtersoft®	—
FUM415XE-CB	6CJ13-044 x 1	Filtersoft®	—
FUM425XE-CB	6IJ15-040 x 1	Filtersoft®	—
FUM525XE-CB	6IJN15-050 x 1	Filtersoft®	—
FUM53XE-CB	6IJ25-050 x 1	Filtersoft®	—
FUS0205YE-CB	4HJN08-024 x 1	Filtersoft®	—
FUS0305YE-CB	4HJN08-030 x 1	Filtersoft®	—
FUS0310YE-CB	4CJN10-030 x 1	Filtersoft®	—
FUS0410YE-CB	4CJN10-040 x 1	Filtersoft®	—
FUS0420YE-CB	4CJN13-040 x 1	Filtersoft®	—
FUS0520YE-CB	4CJN13-050 x 1	Filtersoft®	—
FUS0525YE-CB	4IJN15-050 x 1	Filtersoft®	—
FUS0725YE-CB	4IJN15-070 x 1	Filtersoft®	—
FUS0730YE-CB	4IJN25-070 x 1	Filtersoft®	—
FUS1030YE-CB	4IJN25-100 x 1	Filtersoft®	—
FUS103YE-CB	4IJ25-100 x 1	Filtersoft®	—
FUS1530YE-CB	4IGN25-150 x 1	Filtersoft®	—
FUS153YE-CB	4IG25-150 x 1	Filtersoft®	—
FUS2030YE-CB	4IGN25-200 x 1	Filtersoft®	—
FUS203YE-CB	4IG25-200 x 1	Filtersoft®	—
FUS3030YE-CB	4IGN25-300 x 1	Filtersoft®	—
FUS303YE-CB	4IG25-300 x 1	Filtersoft®	—
FUS3050YE-CB	4QGN43-300 x 1	Filtersoft®	—
FUS305YE-CB	4QG43-300 x 1	Filtersoft®	—
FUS315YE-CB	4CJ13-030 x 1	Filtersoft®	—
FUS31YE-CB	4CJ10-030 x 1	Filtersoft®	—
FUS415YE-CB	4CJ13-044 x 1	Filtersoft®	—
FUS425YE-CB	4IJ15-040 x 1	Filtersoft®	—
FUS525YE-CB	4IJN15-050 x 1	Filtersoft®	—
FUS53YE-CB	4IJ25-050 x 1	Filtersoft®	—
FV1500VE-CB	10ICC25-240 x 1	Filtersoft®	—
FV1500VE-SBM	10DC25-240 x 1	Filtersoft®	—
FV-1500VH-SBM	10DC25-240 x 1	Filtersoft®	—

Competitor Part No.	Parker Finite Part No.	Competitor	Kit Req.
FV1500XE-CB	8ICC25-240 x 1	Filtersoft®	—
FV1500XE-SBM	8DC25-240 x 1	Filtersoft®	—
FV1500ZE-CB	6ICC25-240 x 1	Filtersoft®	—
FV1500ZE-SBM	6DC25-240 x 1	Filtersoft®	—
FV15XE-CB2	6CC15-150 x 2	Filtersoft®	—
FV15ZE-CB2	4CC15-150 x 2	Filtersoft®	—
FV1625VE-CB	10ICC25-300 x 1	Filtersoft®	—
FV1625VE-SBM	10DC25-300 x 1	Filtersoft®	—
FV-1625VH-SBM	10DC25-300 x 1	Filtersoft®	—
FV1625XE-CB	8ICC25-300 x 1	Filtersoft®	—
FV1625XE-SBM	8DC25-300 x 1	Filtersoft®	—
FV1625ZE-CB	6ICC25-300 x 1	Filtersoft®	—
FV1625ZE-SBM	6DC25-300 x 1	Filtersoft®	—
FV22XE-CB	6ICC25-220 x 1	Filtersoft®	—
FV22ZE-CB	4ICC25-220 x 1	Filtersoft®	—
FV860XE-CB	6CC15-060 x 2	Filtersoft®	—
FV860ZE-CB	4CC15-060 x 2	Filtersoft®	—
FV8XE-CB	6CC15-080 x 2	Filtersoft®	—
FV8ZE-CB	4CC15-080 x 2	Filtersoft®	—
FVKE15H-RSA	10DC15-150 x 2	Filtersoft®	—
FVKE15J-PB	3PC15-150 x 2	Filtersoft®	—
FVKE22H-RSA	10DC25-220 x 1	Filtersoft®	—
FVKE22J-PB	3PCC25-220 x 1	Filtersoft®	—
FVKE6J-PB	3PC15-080 x 2	Filtersoft®	—
FVKEJ-PB	3PC15-060 x 2	Filtersoft®	—
FW532-AS	AK15-052 x 4	Filtersoft®	—
FW534-AB	AK25-238 x 1	Filtersoft®	—
FW535-AB	AL25-063 x 2	Filtersoft®	—
FW538-AB	AK35-074 x 2	Filtersoft®	—
FW540-AB	AL10-024 x 4	Filtersoft®	—
FW548YE-CB	6HL10-021 x 4	Filtersoft®	—
FW549YE-CB	6CL10-024 x 4	Filtersoft®	—
FW550YE-CB	6CU10-052 x 4	Filtersoft®	—
FW551YE-CS	6CK15-052 x 4	Filtersoft®	—
FW552YE-CB	6CL25-063 x 2	Filtersoft®	—
FW553YE-CB	6CK35-074 x 2	Filtersoft®	—
FW554YE-CB	6CK25-119 x 2	Filtersoft®	—
FW555YE-CB	6CK25-238 x 1	Filtersoft®	—
FW556WE-CB	8CK25-119 x 2	Filtersoft®	—
FW557WE-CB	8CK25-238 x 1	Filtersoft®	—
FW558-AB	AK25-080 x 2	Filtersoft®	—
FW559YE-CB	6CK25-080 x 2	Filtersoft®	—
FW560YE-CBA	6CK35-074 x 2	Filtersoft®	—
FW561YE-CBA	6CK35-106 x 1	Filtersoft®	—
FW562YE-CBA	6CK35-172 x 1	Filtersoft®	—

Competitor Part No.	Parker Finite Part No.	Competitor	Kit Req.
FW563-ABA	AK35-074 x 2	Filtersoft®	—
FW564-ABA	AK35-106 x 1	Filtersoft®	—
FW565-ABA	AK35-172 x 1	Filtersoft®	—
FW874WE-CBA	8CK35-074 x 2	Filtersoft®	—
FW875WE-CBA	8CK35-106 x 1	Filtersoft®	—
FW876WE-CBA	8CK35-172 x 1	Filtersoft®	—
FW988WE-CB	8HL10-021 x 4	Filtersoft®	—
FW989WE-CB	8CL10-024 x 4	Filtersoft®	—
FW992WE-CS	8CK15-052 x 4	Filtersoft®	—
G78A3 (9-3/4")	3PP15-098 x 2	Cuno® (AMF Cuno)	—
G78B2 (9-3/4")	3PP15-098 x 2	Cuno® (AMF Cuno)	—
G80A3 (10")	3PP15-100 x 2	Cuno® (AMF Cuno)	—
G80B2 (10")	3PP15-100 x 2	Cuno® (AMF Cuno)	—
GPC-125PF	6QP19-075 x 2	Pall/ Pneumatic Products Corp.	—
GPC-175AF	3PP19-075 x 2	Pall/ Pneumatic Products Corp.	—
GPC-400PF	6QP25-127 x 1	Pall/ Pneumatic Products Corp.	—
H130	10DZ15-060	Zeks®	—
H230	10DZ15-095	Zeks®	—
H300	10DZ19-095	Zeks®	—
H450	10DZ19-193	Zeks®	—
H600	10DZ19-193	Zeks®	—
HK71311C	6CH25-260 x 1	Flair	—
HK71312C	6CU25-187 x 1	Flair (elements that require kits)	KX-2
HK7132C	6CM10-025 x 8	Flair (elements that require kits)	KX-21
HK7133C	6CM10-050 x 4	Flair (elements that require kits)	KX-22
HK7134C	6CM15-060 x 4	Flair (elements that require kits)	KX-23
HK7135C	6CM15-095 x 2	Flair (elements that require kits)	KX-24
HK7136C	6CM15-185 x 2	Flair (elements that require kits)	KX-25

Competitor Part No.	Parker Finite Part No.	Competitor	Kit Req.	Competitor Part No.	Parker Finite Part No.	Competitor	Kit Req.
HK7137C	6CU25-187 x 1	Flair (elements that require kits)	KX-2	MCC-1201SU	6QP28-132 x 2	Pall/ Pneumatic Products Corp.	—
HK7313P	10CM10-025 x 8	Flair (elements that require kits)	KX-21	MCC-1202HT	10DP26-265 x 1	Pall/ Pneumatic Products Corp.	—
HK7314P	10CM10-050 x 4	Flair (elements that require kits)	KX-22	MCC-1202SU	6QP28-265 x 1	Pall/ Pneumatic Products Corp.	—
HK7315P	10CM15-060 x 4	Flair (elements that require kits)	KX-23	MCC-4463SU	6QP14-051 x 4	Pall/ Pneumatic Products Corp.	—
HK7316P	10CM15-095 x 2	Flair (elements that require kits)	KX-24	MCS-1001CE	AP19-098 x 2	Pall/ Pneumatic Products Corp.	—
HK7317P	10CM15-185 x 2	Flair (elements that require kits)	KX-25	MCS-1001HT	10DPS19-098 x 2	Pall/ Pneumatic Products Corp.	—
HK7318P	10CU25-187 x 1	Flair (elements that require kits)	KX-2	MCS-1001SU	6QP19-098 x 2	Pall/ Pneumatic Products Corp.	—
HK7319P	10CH25-260 x 1	Flair	—	MCS-1002HT	10DPS19-198 x 2	Pall/ Pneumatic Products Corp.	—
KE-15	3PC15-150 x 2	Van Air®	—	MCS-4463AF	3PP14-051 x 4	Pall/ Pneumatic Products Corp.	—
KE-15HT	10DC15-150 x 2	Van Air®	—	MCS-4463EC	3PP14-051 x 4	Pall/ Pneumatic Products Corp.	—
KE-22	3PCC25-220 x 1	Van Air®	—	MCS-4463SU	6QP14-051 x 4	Pall/ Pneumatic Products Corp.	—
KE-22HT	10DC25-220 x 1	Van Air®	—	MDC-1001AF	3PP19-098 x 2	Pall/ Pneumatic Products Corp.	—
KE-6/100	3PC15-080 x 2	Van Air®	—	MDC-1001CE	AP19-098 x 2	Pall/ Pneumatic Products Corp.	—
KE-6/60	3PC15-060 x 2	Van Air®	—	MDC-1001CV	AP19-098 x 2	Pall/ Pneumatic Products Corp.	—
L100	6CZ15-060	Zeks®	—	MDC-1001HT	10DP19-098 x 2	Pall/ Pneumatic Products Corp.	—
L140	6CZ15-095	Zeks®	—	MDC-1001SAU	AP19-098 x 2	Pall/ Pneumatic Products Corp.	—
L18	6CZ10-025	Zeks®	—	MDC-1001SU	6QP19-098 x 2	Pall/ Pneumatic Products Corp.	—
L200	6CZ19-095	Zeks®	—	MDC-1002AF	3PP19-198 x 2	Pall/ Pneumatic Products Corp.	—
L300	6CZ19-193	Zeks®	—				
L400	6CZ19-193	Zeks®	—				
L50	6CZ10-050	Zeks®	—				
L80	6CZ15-060	Zeks®	—				
MCC-1001HT	10DP19-098 x 2	Pall/ Pneumatic Products Corp.	—				
MCC-1001SU	6QP19-098 x 2	Pall/ Pneumatic Products Corp.	—				
MCC-1002HT	10DP19-198 x 2	Pall/ Pneumatic Products Corp.	—				
MCC-1002SU	6QP19-198 x 2	Pall/ Pneumatic Products Corp.	—				
MCC-1201HT	10DP26-132 x 2	Pall/ Pneumatic Products Corp.	—				

Competitor Part No.	Parker Finite Part No.	Competitor	Kit Req.
MDC-1002HT	10DP19-198 x 2	Pall/ Pneumatic Products Corp.	—
MDC-1002SAU	AP19-198 x 2	Pall/ Pneumatic Products Corp.	—
MDC-1201AF	3PP26-132 x 2	Pall/ Pneumatic Products Corp.	—
MDC-1201HT	10DP26-132 x 2	Pall/ Pneumatic Products Corp.	—
MDC-1201SAU	AP26-132 x 2	Pall/ Pneumatic Products Corp.	—
MDC-1201SU	6QP28-132 x 2	Pall/ Pneumatic Products Corp.	—
MDC-1202EC	3PP26-265 x 1	Pall/ Pneumatic Products Corp.	—
MDC-1202HT	10DP26-265 x 1	Pall/ Pneumatic Products Corp.	—
MDC-1202SAU	AP26-265 x 1	Pall/ Pneumatic Products Corp.	—
MDC-1202SU	6QP28-265 x 1	Pall/ Pneumatic Products Corp.	—
MDC-4463AF	3PP14-051 x 4	Pall/ Pneumatic Products Corp.	—
MDC-4463SAU	AP14-051 x 4	Pall/ Pneumatic Products Corp.	—
MDC-4463SU	6QP14-051 x 4	Pall/ Pneumatic Products Corp.	—
MDS-1001HT	10DPS19-098 x 2	Pall/ Pneumatic Products Corp.	—
MDS-1001SU	6QP19-098 x 2	Pall/ Pneumatic Products Corp.	—
MDS-1002HT	10DPS19-198 x 2	Pall/ Pneumatic Products Corp.	—
MDS-1201SU	6QPS28-132 x 2	Pall/ Pneumatic Products Corp.	—
MDS-4463SU	6QP14-051 x 4	Pall/ Pneumatic Products Corp.	—

Competitor Part No.	Parker Finite Part No.	Competitor	Kit Req.
MF 02/05	6HJN08-024 x 1	Ultrafilter/ Donaldson®	—
MF 03/05	6HJN08-030 x 1	Ultrafilter/ Donaldson®	—
MF 03/10	6CJN10-030 x 1	Ultrafilter/ Donaldson®	—
MF 04/10	6CJN10-040 x 1	Ultrafilter/ Donaldson®	—
MF 04/20	6CJN13-040 x 1	Ultrafilter/ Donaldson®	—
MF 05/20	6CJN13-050 x 1	Ultrafilter/ Donaldson®	—
MF 05/25	6IJN15-050 x 1	Ultrafilter/ Donaldson®	—
MF 07/25	6IJN15-070 x 1	Ultrafilter/ Donaldson®	—
MF 07/30	6IJN25-070 x 1	Ultrafilter/ Donaldson®	—
MF 10/3	6IJ25-100 x 1	Ultrafilter/ Donaldson®	—
MF 10/30	6IJN25-100 x 1	Ultrafilter/ Donaldson®	—
MF 15/3	6IG25-150 x 1	Ultrafilter/ Donaldson®	—
MF 15/30	6IGN25-150 x 1	Ultrafilter/ Donaldson®	—
MF 20/3	6IG25-200 x 1	Ultrafilter/ Donaldson®	—
MF 20/30	6IGN25-200 x 1	Ultrafilter/ Donaldson®	—
MF 3/1	6CJ10-030 x 1	Ultrafilter/ Donaldson®	—
MF 3/1,5	6CJ13-030 x 1	Ultrafilter/ Donaldson®	—
MF 30/3	6IG25-300 x 1	Ultrafilter/ Donaldson®	—
MF 30/30	6IGN25-300 x 1	Ultrafilter/ Donaldson®	—
MF 30/5	6QG43-300 x 1	Ultrafilter/ Donaldson®	—
MF 30/50	6QGN43-300 x 1	Ultrafilter/ Donaldson®	—
MF 4/1,5	6CJ13-044 x 1	Ultrafilter/ Donaldson®	—
MF 4/2,5	6IJ15-040 x 1	Ultrafilter/ Donaldson®	—
MF 5/2,5	6IJN15-050 x 1	Ultrafilter/ Donaldson®	—
MF 5/3	6IJ25-050 x 1	Ultrafilter/ Donaldson®	—
OL-5C	6QP14-051 x 4	Pall/ Pneumat- ic Products Corp.	—

Competitor Part No.	Parker Finite Part No.	Competitor	Kit Req.
OL-9C	6QP19-098 x 2	Pall/ Pneumatic Products Corp.	—
P-025-10	3PU10-025 X 8	Pneumatech/ Atlas Copco	—
P-050-10	3PU10-050 X 4	Pneumatech/ Atlas Copco	—
P-060-15	3PU15-060 X 4	Pneumatech/ Atlas Copco	—
P-095-15	3PU15-095 X 2	Pneumatech/ Atlas Copco	—
P-130-25	3PU25-130 X 1	Pneumatech/ Atlas Copco	—
P150	3PZ15-060	Zeks®	—
P-187-25	3PU25-187 X 1	Pneumatech/ Atlas Copco	—
P-235-25	3PU25-235 X 1	Pneumatech/ Atlas Copco	—
P-250-85	3PU85-250 X 1	Pneumatech/ Atlas Copco	—
P275	3PZ15-095	Zeks®	—
P-280-35	3PU35-280 X 1	Pneumatech/ Atlas Copco	—
P-280-51	3PU51-280 X 1	Pneumatech/ Atlas Copco	—
P30	3PZ10-025	Zeks®	—
P3-280-51	3PU51-280 X 1 (3 req'd)	Pneumatech/ Atlas Copco	—
P330	3PZ19-095	Zeks®	—
P-360-85	3PU85-360 X 1	Pneumatech/ Atlas Copco	—
P500	3PZ19-193	Zeks®	—
P670	3PZ19-193	Zeks®	—
P75	3PZ10-050	Zeks®	—
P-AK 07/30	AGN25-070 X 1	Ultrafilter/ Donaldson®	—
P-AK 10-30	AGN25-100 X 1	Ultrafilter/ Donaldson®	—
PCC-060AF	3PP14-051 x 4	Pall/ Pneumatic Products Corp.	—
PCC-1001AF	3PP19-098 x 2	Pall/ Pneumatic Products Corp.	—
PCC-1001HT	10DP19-098 x 2	Pall/ Pneumatic Products Corp.	—
PCC-1001SU	6QP19-098 x 2	Pall/ Pneumatic Products Corp.	—

Competitor Part No.	Parker Finite Part No.	Competitor	Kit Req.
PCC-1002AF	3PP19-198 x 2	Pall/ Pneumatic Products Corp.	—
PCC-1002HT	10DP19-198 x 2	Pall/ Pneumatic Products Corp.	—
PCC-1002SU	6QP19-198 x 2	Pall/ Pneumatic Products Corp.	—
PCC-1003AF	3PP19-298 x 1	Pall/ Pneumatic Products Corp.	—
PCC-1003HT	10DP19-298 x 1	Pall/ Pneumatic Products Corp.	—
PCC-1003SU	6QP19-298 x 1	Pall/ Pneumatic Products Corp.	—
PCC-1200AF	3PP30-295 x 1	Pall/ Pneumatic Products Corp.	—
PCC-1200HT	10DP30-295 x 1	Pall/ Pneumatic Products Corp.	—
PCC-1200SU	6QP30-295 x 1	Pall/ Pneumatic Products Corp.	—
PCC-1201AF	3PP26-132 x 2	Pall/ Pneumatic Products Corp.	—
PCC-1201HT	10DP26-132 x 2	Pall/ Pneumatic Products Corp.	—
PCC-1201SU	6QP28-132 x 2	Pall/ Pneumatic Products Corp.	—
PCC-1202EC	3PP26-265 x 1	Pall/ Pneumatic Products Corp.	—
PCC-1202HT	10DP26-265 x 1	Pall/ Pneumatic Products Corp.	—
PCC-1202SU	6QP28-265 x 1	Pall/ Pneumatic Products Corp.	—
PCC-350AF	3PP30-143 x 1	Pall/ Pneumatic Products Corp.	—
PCC-350HT	10DP30-143 x 1	Pall/ Pneumatic Products Corp.	—
PCC-350SU	6QP30-143 x 1	Pall/ Pneumatic Products Corp.	—

Competitor Part No.	Parker Finite Part No.	Competitor	Kit Req.	Competitor Part No.	Parker Finite Part No.	Competitor	Kit Req.
PCC-4463AF	3PP14-051 x 4	Pall/ Pneumatic Products Corp.	—	PCS-350HT	10DPS30-143 x 1	Pall/ Pneumatic Products Corp.	—
PCC-4463SU	6QP14-051 x 4	Pall/ Pneumatic Products Corp.	—	PCS-350SU	6QPS30-143 x 1	Pall/ Pneumatic Products Corp.	—
PCC-600AF	3PP30-140 x 1	Pall/ Pneumatic Products Corp.	—	PCS-4463AF	3PP14-051 x 4	Pall/ Pneumatic Products Corp.	—
PCC-600HT	10DP30-140 x 1	Pall/ Pneumatic Products Corp.	—	PCS-4463SU	6QP14-051 x 4	Pall/ Pneumatic Products Corp.	—
PCC-600SU	6QP30-140 x 1	Pall/ Pneumatic Products Corp.	—	PCS-700AF	3PPS30-295 x 1	Pall/ Pneumatic Products Corp.	—
PCC-700AF	3PP30-295 x 1	Pall/ Pneumatic Products Corp.	—	PCS-700HT	10DPS30-295 x 1	Pall/ Pneumatic Products Corp.	—
PCC-700HT	10DP30-295 x 1	Pall/ Pneumatic Products Corp.	—	PCS-700SU	6QPS30-295 x 1	Pall/ Pneumatic Products Corp.	—
PCC-700SU	6QP30-295 x 1	Pall/ Pneumatic Products Corp.	—	PE 02/05	12GJN08-024 x 1	Pall/ Pneumatic Products Corp.	—
PCS-060AF	3PP14-051 x 4	Pall/ Pneumatic Products Corp.	—	PE 03/05	12GJN08-030 x 1	Pall/ Pneumatic Products Corp.	—
PCS-1001AF	3PP19-098 x 2	Pall/ Pneumatic Products Corp.	—	PE 03/10	3PJN10-030 x 1	Pall/ Pneumatic Products Corp.	—
PCS-1001HT	10DPS19-098 x 2	Pall/ Pneumatic Products Corp.	—	PE 04/10	3PJN10-040 x 1	Pall/ Pneumatic Products Corp.	—
PCS-1001SU	6QP19-098 x 2	Pall/ Pneumatic Products Corp.	—	PE 04/20	3PJN13-040 x 1	Pall/ Pneumatic Products Corp.	—
PCS-1002AF	3PP19-198 x 2	Pall/ Pneumatic Products Corp.	—	PE 05/20	3PJN13-050 x 1	Pall/ Pneumatic Products Corp.	—
PCS-1002HT	10DPS19-198 x 2	Pall/ Pneumatic Products Corp.	—	PE 05/25	3PJN15-050 x 1	Ultrafilter/ Donaldson®	—
PCS-1002SU	6QP19-198 x 2	Pall/ Pneumatic Products Corp.	—	PE 07/25	3PJN15-070 x 1	Ultrafilter/ Don- aldson®	—
PCS-1200AF	3PPS30-295 x 1	Pall/ Pneumatic Products Corp.	—	PE 07/30	3PJN25-070 x 1	Ultrafilter/ Donaldson®	—
PCS-1200HT	10DPS30-295 x 1	Pall/ Pneumatic Products Corp.	—	PE 10/30	3PJN25-100 x 1	Ultrafilter/ Donaldson®	—
PCS-350AF	3PPS30-143 x 1	Pall/ Pneumatic Products Corp.	—	PE 15/30	3PGN25-150 x 1	Ultrafilter/ Donaldson®	—
				PE 20/30	3PGN25-200 x 1	Ultrafilter/ Donaldson®	—
				PE 30/30	3PGN25-300 x 1	Ultrafilter/ Donaldson®	—

Competitor Part No.	Parker Finite Part No.	Competitor	Kit Req.
PE 30/50	3PGN43-300 x 1	Ultrafilter/ Donaldson®	—
P-FF 07/30	10IJN25-070 X 1	Ultrafilter/ Donaldson®	—
P-FF 10/30	10IJN25-100 X 1	Ultrafilter/ Donaldson®	—
P-MF 07/30	6IGN25-070 X 1	Ultrafilter/ Donaldson®	—
P-MF 10/30	6IGN25-100 X 1	Ultrafilter/ Donaldson®	—
POC-035SU	6QP14-051 x 4	Pall/ Pneumatic Products Corp.	—
POC-060SU	6QP14-051 x 4	Pall/ Pneumatic Products Corp.	—
POC-1001SU	6QP19-098 x 2	Pall/ Pneumatic Products Corp.	—
POC-1200SU	6QP30-295 x 1	Pall/ Pneumatic Products Corp.	—
POC-1201SU	6QP28-132 x 2	Pall/ Pneumatic Products Corp.	—
POC-600SU	6QP30-140 x 1	Pall/ Pneumatic Products Corp.	—
POS-1001SU	6QPS19-098 x 2	Pall/ Pneumatic Products Corp.	—
POS-1201SU	6QPS28-132 x 2	Pall/ Pneumatic Products Corp.	—
POS-600SU	6QPS30-140 x 1	Pall/ Pneumatic Products Corp.	—
POS-700SU	6QPS30-295 x 1	Pall/ Pneumatic Products Corp.	—
PPC-1200SU	6QP30-295 x 1	Pall/ Pneumatic Products Corp.	—
PPC-1201SU	6QP28-132 x 2	Pall/ Pneumatic Products Corp.	—
PPC-1202SU	6QP28-265 x 1	Pall/ Pneumatic Products Corp.	—
PPC-350SU	6QP30-143 x 1	Pall/ Pneumatic Products Corp.	—
PPC-700SU	6QP30-295 x 1	Pall/ Pneumatic Products Corp.	—

Competitor Part No.	Parker Finite Part No.	Competitor	Kit Req.
P-PE 07/30	3PGN25-070 X 1	Pall/ Pneumatic Products Corp.	—
P-PE 10/30	3PGN25-100 X 1	Pall/ Pneumatic Products Corp.	—
PPY-1001SU	6QP19-098 x 2	Pall/ Pneumatic Products Corp.	—
PPY-1002SU	6QP19-198 x 2	Pall/ Pneumatic Products Corp.	—
PPY-1003SU	6QP19-298 x 1	Pall/ Pneumatic Products Corp.	—
P-SMF 07/30	4IGN25-070 X 1	Ultrafilter/ Don- aldson®	—
P-SMF 10/30	4IGN25-100 X 1	Ultrafilter/ Don- aldson®	—
Q-025-10	6QU10-025 X 8	Pneumatech/ Atlas Copco	—
Q-050-10	6QU10-050 X 4	Pneumatech/ Atlas Copco	—
Q-060-15	6QU15-060 X 4	Pneumatech/ Atlas Copco	—
Q-095-15	6QU15-095 X 2	Pneumatech/ Atlas Copco	—
Q-130-25	6QU25-130 X 1	Pneumatech/ Atlas Copco	—
Q-187-25	6QU25-187 X 1	Pneumatech/ Atlas Copco	—
Q-235-25	6QU25-235 X 1	Pneumatech/ Atlas Copco	—
Q-280-35	6QU35-280 X 1	Pneumatech/ Atlas Copco	—
R130	10CZ15-060	Zeks®	—
R230	10CZ15-095	Zeks®	—
R25	10CZ10-025	Zeks®	—
R300	10CZ19-095	Zeks®	—
R450	10CZ19-193	Zeks®	—
R60	10CZ10-050	Zeks®	—
R600	10CZ19-193	Zeks®	—
R80	10CZ10-050	Zeks®	—
SB12	3PU19-050 x 2	Henderson	KX- 12
SB4	3PN10-038 x 4	Henderson	KX- 11
SMF 02/05	4HJN08-024 x 1	Ultrafilter/ Donaldson®	—
SMF 03/05	4HJN08-030 x 1	Ultrafilter/ Donaldson®	—

Competitor Part No.	Parker Finite Part No.	Competitor	Kit Req.
SMF 03/10	4CJN10-030 x 1	Ultrafilter/ Donaldson®	—
SMF 04/10	4CJN10-040 x 1	Ultrafilter/ Donaldson®	—
SMF 04/20	4CJN13-040 x 1	Ultrafilter/ Donaldson®	—
SMF 05/20	4CJN13-050 x 1	Ultrafilter/ Donaldson®	—
SMF 05/25	4IJN15-050 x 1	Ultrafilter/ Donaldson®	—
SMF 07/25	4IJN15-070 x 1	Ultrafilter/ Donaldson®	—
SMF 07/30	4IJN25-070 x 1	Ultrafilter/ Donaldson®	—
SMF 10/3	4IJ25-100 x 1	Ultrafilter/ Donaldson®	—
SMF 10/30	4IJN25-100 x 1	Ultrafilter/ Donaldson®	—
SMF 15/3	4IG25-150 x 1	Ultrafilter/ Donaldson®	—
SMF 15/30	4IGN25-150 x 1	Ultrafilter/ Donaldson®	—
SMF 20/3	4IG25-200 x 1	Ultrafilter/ Donaldson®	—
SMF 20/30	4IGN25-200 x 1	Ultrafilter/ Donaldson®	—
SMF 3/1	4CJ10-030 x 1	Ultrafilter/ Donaldson®	—
SMF 3/1,5	4CJ13-030 x 1	Ultrafilter/ Donaldson®	—
SMF 30/3	4IG25-300 x 1	Ultrafilter/ Donaldson®	—
SMF 30/30	4IGN25-300 x 1	Ultrafilter/ Donaldson®	—
SMF 30/5	4QG43-300 x 1	Ultrafilter/ Donaldson®	—
SMF 30/50	4QGN43-300 x 1	Ultrafilter/ Donaldson®	—
SMF 4/1,5	4CJ13-044 x 1	Ultrafilter/ Donaldson®	—
SMF 4/2,5	4IJ15-040 x 1	Ultrafilter/ Donaldson®	—
SMF 5/2,5	4IJN15-050 x 1	Ultrafilter/ Donaldson®	—
SMF 5/3	4IJ25-050 x 1	Ultrafilter/ Donaldson®	—
U78A3 (9-3/4")	3PP15-098 x 2	Cuno® (AMF Cuno)	—
U78B2 (9-3/4")	3PP15-098 x 2	Cuno® (AMF Cuno)	—
U80A3 (10")	3PP15-100 x 2	Cuno® (AMF Cuno)	—

Competitor Part No.	Parker Finite Part No.	Competitor	Kit Req.
U80B2 (10")	3PP15-100 x 2	Cuno® (AMF Cuno)	—
UFAK0205	AJN08-024 x 1	Flair	—
UFAK0305	AJN08-030 x 1	Flair	—
UFAK0310	AJN10-030 x 1	Flair	—
UFAK0410	AJN10-040 x 1	Flair	—
UFAK0420	AJN13-040 x 1	Flair	—
UFAK0520	AJN13-050 x 1	Flair	—
UFAK0525	AJN15-050 x 1	Flair	—
UFAK0725	AJN15-070 x 1	Flair	—
UFAK0730	AJN25-070 x 1	Flair	—
UFAK1030	AJN25-100 x 1	Flair	—
UFAK1530	AGN25-150 x 1	Flair	—
UFAK2030	AGN25-200 x1	Flair	—
UFAK3030	AGN25-300 x 1	Flair	—
UFAK3050	AGN43-300 x 1	Flair	—
UFFF0205	10HJN08-024 x 1	Flair	—
UFFF0305	10HJN08-030 x 1	Flair	—
UFFF0310	10CJN10-030 x 1	Flair	—
UFFF0410	10CJN10-040 x 1	Flair	—
UFFF0420	10CJN13-040 x 1	Flair	—
UFFF0520	10CJN13-050 x 1	Flair	—
UFFF0525	10IJN15-050 x 1	Flair	—
UFFF0725	10IJN15-070 x 1	Flair	—
UFFF0730	10IJN25-070 x 1	Flair	—
UFFF1030	10IJN25-100 x 1	Flair	—
UFFF1530	10IGN25-150 x 1	Flair	—
UFFF2030	10IGN25-200 x 1	Flair	—
UFFF3030	10IGN25-300 x 1	Flair	—
UFFF3050	10QGN43-300 x 1	Flair	—
UFMF0205	6HJN08-024 x 1	Flair	—
UFMF0305	6HJN08-030 x 1	Flair	—
UFMF0310	6CJN10-030 x 1	Flair	—
UFMF0410	6CJN10-040 x 1	Flair	—
UFMF0420	6CJN13-040 x 1	Flair	—
UFMF0520	6CJN13-050 x 1	Flair	—
UFMF0525	6IJN15-050 x 1	Flair	—
UFMF0725	6IJN15-070 x 1	Flair	—
UFMF0730	6IJN25-070 x 1	Flair	—
UFMF1030	6IJN25-100 x 1	Flair	—
UFMF1530	6IGN25-150 x 1	Flair	—
UFMF2030	6IGN25-200 x 1	Flair	—
UFMF3030	6IGN25-300 x 1	Flair	—
UFMF3050	6QGN43-300 x 1	Flair	—
UFPE0205	12GJN08-024 x 1	Flair	—

Competitor Part No.	Parker Finite Part No.	Competitor	Kit Req.
UFPE0305	12GJN08-030 x 1	Flair	—
UFPE0310	3PJN10-030 x 1	Flair	—
UFPE0410	3PJN10-040 x 1	Flair	—
UFPE0420	3PJN13-040 x 1	Flair	—
UFPE0520	3PJN13-050 x 1	Flair	—
UFPE0525	3PJN15-050 x 1	Flair	—
UFPE0725	3PJN15-070 x 1	Flair	—
UFPE0730	3PJN25-070 x 1	Flair	—
UFPE1030	3PJN25-100 x 1	Flair	—
UFPE1530	3PGN25-150 x 1	Flair	—
UFPE2030	3PGN25-200 x 1	Flair	—
UFPE3030	3PGN25-300 x 1	Flair	—
UFPE3050	3PGN43-300 x 1	Flair	—
UFSMF0205	4HJN08-024 x 1	Flair	—
UFSMF0305	4HJN08-030 x 1	Flair	—
UFSMF0310	4CJN10-030 x1	Flair	—
UFSMF0410	4CJN10-040 x 1	Flair	—
UFSMF0420	4CJN13-040 x 1	Flair	—
UFSMF0520	4CJN13-050 x 1	Flair	—
UFSMF0525	4IJN15-050 x 1	Flair	—
UFSMF0725	4IJN15-070 x 1	Flair	—
UFSMF0730	4IJN25-070 x 1	Flair	—
UFSMF1030	4IJN25-100 x 1	Flair	—
UFSMF1530	4IGN25-150 x 1	Flair	—
UFSMF2030	4IGN25-200 x 1	Flair	—
UFSMF3030	4IGN25-300 x 1	Flair	—
UFSMF3050	4QGN43-300 x 1	Flair	—
VCE15	6CC15-150 x 2	Flair	—
VCE22	6ICC25-220 x 1	Flair	—
VCE8100	6CC15-080 x 2	Flair	—
VCE860	6CC15-060 x 2	Flair	—
VCXE15	4CC15-150 x 2	Flair	—
VCXE22	4ICC25-220 x 1	Flair	—
VCXE8100	4CC15-080 x 2	Flair	—
VCXE860	4CC15-060 x 2	Flair	—
VE111250B	8ICC25-240 x 1	Flair	—
VE11125RB	8DC25-240 x 1	Flair	—
VE111265B	8ICC25-300 x 1	Flair	—
VE111265RB	8DC25-300 x 1	Flair	—
VKE15	3PC15-150 x 2	Flair	—
VKE15HT	10DC15-150 x 2	Flair	—
VKE22	3PCC25-220 x 1	Flair	—
VKE22HT	10DC25-220 x 1	Flair	—
VKE6100	3PC15-080 x 2	Flair	—
VKE660	3PC15-060 x 2	Flair	—

Competitor Part No.	Parker Finite Part No.	Competitor	Kit Req.
V-PE 10/3	3PJ25-100 x 1	Ultrafilter/ Donaldson®	—
V-PE 15/3	3PG25-150 x 1	Ultrafilter/ Donaldson®	—
V-PE 20/3	3PG25-200 x 1	Ultrafilter/ Donaldson®	—
V-PE 3/1	3PJ10-030 x 1	Ultrafilter/ Donaldson®	—
V-PE 3/1,5	3PJ13-030 x 1	Ultrafilter/ Donaldson®	—
V-PE 30/3	3PG25-300 x 1	Ultrafilter/ Donaldson®	—
V-PE 30/5	3PG43-300 x 1	Ultrafilter/ Donaldson®	—
V-PE 4/1,5	3PJ13-044 x 1	Ultrafilter/ Donaldson®	—
V-PE 4/2,5	3PJ15-040 x 1	Ultrafilter/ Donaldson®	—
V-PE 5/2,5	3PJN15-050 x 1	Ultrafilter/ Donaldson®	—
V-PE 5/3	3PJ25-050 x 1	Ultrafilter/ Donaldson®	—
Z1050A	AZ12-023 x 1	Flair	—
Z1050V	3PZ12-023 x 1	Flair	—
Z1050X	6CZ12-023 x 1	Flair	—
Z1050Y	8CZ12-023 x 1	Flair	—
Z1050Z	10CZ12-023 x 1	Flair	—
Z1070A	AZ12-029 x 1	Flair	—
Z1070V	3PZ12-029 x 1	Flair	—
Z1070X	6CZ12-029 x 1	Flair	—
Z1070Y	8CZ12-029 x 1	Flair	—
Z1070Z	10CZ12-029 x 1	Flair	—
Z1140A	AZ12-056 x 1	Flair	—
Z1140V	3PZ12-056 x 1	Flair	—
Z1140X	6CZ12-056 x 1	Flair	—
Z1140Y	8CZ12-056 x 1	Flair	—
Z1140Z	10CZ12-056 x 1	Flair	—
Z2010A	AZ20-046 x 1	Flair	—
Z2010V	3PZ20-046 x 1	Flair	—
Z2010X	6CZ20-046 x 1	Flair	—
Z2010Y	8CZ20-046 x 1	Flair	—
Z2010Y	8CZ20-046 x 1	Flair	—
Z2010Z	10CZ20-046 x 1	Flair	—
Z2010Z	10CZ20-046 x 1	Flair	—
Z2020A	AZ20-086 x 1	Flair	—
Z2020A	AZ20-086 x 1	Flair	—
Z2020V	3PZ20-086 x 1	Flair	—
Z2020V	3PZ20-086 x 1	Flair	—

Competitor Part No.	Parker Finite Part No.	Competitor	Kit Req.
Z2020X	6CZ20-086 x 1	Flair	—
Z2020Y	8CZ20-086 x 1	Flair	—
Z2020Z	10CZ20-086 x 1	Flair	—
Z2030A	AZ20-126 x 1	Flair	—
Z2030V	3PZ20-126 x 1	Flair	—
Z2030X	6CZ20-126 x 1	Flair	—
Z2030Y	8CZ20-126 x 1	Flair	—
Z2030Z	10CZ20-126 x 1	Flair	—
Z2050A	AZ20-200 x 1	Flair	—
Z2050V	3PZ20-200 x 1	Flair	—
Z2050X	6CZ20-200 x 1	Flair	—
Z2050Y	8CZ20-200 x 1	Flair	—
Z2050Z	10CZ20-200 x 1	Flair	—
Z3050A	AZ27-200 x 1	Flair	—
Z3050V	3PZ27-200 x 1	Flair	—
Z3050X	6CZ27-200 x 1	Flair	—
Z3050Y	8CZ27-200 x 1	Flair	—
Z3050Z	10CZ27-200 x 1	Flair	—
Z3075A	AZ27-298 x 1	Flair	—
Z3075V	3PZ27-298 x 1	Flair	—
Z3075X	6CZ27-298 x 1	Flair	—
Z3075Y	8CZ27-298 x 1	Flair	—
Z3075Z	10CZ27-298 x 1	Flair	—
Z5075A	AZ50-298 x 1	Flair	—
Z5075V	3PZ50-298 x 1	Flair	—
Z5075X	6CZ50-298 x 1	Flair	—
Z5075Y	8CZ50-298 x 1	Flair	—
Z5075Z	10CZ50-298 x 1	Flair	—



Finite Accessories

Bulletin 1300 - 155/USA Rev A



ENGINEERING YOUR SUCCESS.

Finite's Featured Air Line Filtration Accessories

For a comprehensive list and to find out where these accessories are used, please see pages 164-165.

 <p>DPG-15HP Differential Pressure Gauge Temp: 200°F (93°C) Pressure: 800 PSIG (55 bar)</p>	 <p>DPI-25 Differential Pressure Gauge Temp: 200°F (88°C) Pressure: 5000 PSIG (340 bar) 1/4" NPT Connections</p>
 <p>DPI-13 Differential Pressure Indicator Temp: 175°F (79°C) Pressure: 250 PSIG (17 bar) 1/8" NPT Connections</p>	 <p>KBDPI-25 Differential Pressure Gauge Temp: 200°F (88°C) Pressure: 250 PSIG (17 bar) (Kit includes 1/8" and 1/4" NPT brass fittings, flexible nylon tubing and mounting bracket)</p>
 <p>DPG-15 Differential Pressure Gauge Temp: 175°F (79°C) Pressure: 500 PSIG (34 bar) (Fits on pre-drilled H-Series housings only)</p>	 <p>MBS-1 Stainless Steel Mounting Bracket MBS-2 2222 FFC</p>
 <p>KBDPG-15 Differential Pressure Gauge Kit Temp: 200°F (93°C) Pressure: 250 PSIG (17 bar) (Kit includes 1/8" and 1/4" NPT brass fittings, flexible nylon tubing and mounting bracket)</p>	 <p>Mounting Brackets BK-M (1/4" to 1/2" NPT) BK-3 (3/4" to 1" NPT)</p>
 <p>K4520N14060, K4520N14160 Pressure Gauges Temp: 125°F (52°C) Pressure: 0-60 PSIG (0-4 bar), 0-160 PSIG (0-11 bar)</p>	 <p>KV-2A, KV-5A, KV-6A Element Frame Kits (Internally mounted in all ASME housings)</p>

 <p>VS-50 Visual Sump Drain Temp: 125°F (52°C) Pressure: 150 PSIG (10 bar) 1/2" NPT Inlet Connection 1/8" NPT Drain Connection</p>	 <p>MS-50 Metal Sump Drain (External) Temp: 175°F (79°C) Pressure: 10-250 PSIG (17 bar) 1/2" NPT Inlet Connection 1/8" NPT Drain Connection</p>
 <p>TD-50 Adjustable Timed Drain Valve Temp: 150°F (66°C) Pressure: 600 PSIG (42 bar) 1/2" NPT Inlet and Outlet Connections</p>	 <p>ADT-50 Float Actuated Drain Trap Temp: 450°F (232°C) Pressure: 289 PSIG (20 bar) 1/2" NPT Inlet Connection 1/4" NPT Outlet Connection</p>
 <p>ZLD Zero Loss Drains Temp: 35°-140°F (2°-60°C) Pressure: 2-232 PSI (.2-16 bar)</p> <p>ZLD-006 ZLD-013 ZLD-023</p>	 <p>ADS-50 Stainless Steel (304) Automatic Drain Trap Temp: 450°F (232°C) Pressure: 400 PSI (27 bar) 1/2" NPT Inlet and Outlet Connections</p>
 <p>TV-25 Timed Drain Valve Temp: 230°F (110°C) Pressure: 300 PSIG (20 bar) 1/4" NPT</p> <p>TV-25-700 Timed Drain Valve Temp: 210°F (99°C) Pressure: 700 PSIG (48 bar) 1/4" NPT</p>	<p>TV-50 Timed Drain Valve Temp: 210°F (99°C) Pressure: 300 PSIG (20 bar) 1/2" NPT</p>
 <p>AD-12 Automatic Drain Valve (Internal) Temp: 175°F (79°C) Pressure: 10-250 PSIG (17 bar) 1/8" NPT Drain Connection</p>	

Where Used Chart

Use the chart below to find out what accessory can be used on what Finite® product. If you have any questions regarding accessories, please call our technical assistance department at 1-800-521-4357.

Model Number	Port (NPT)	Max Press. (PSIG)	Max Temp. (F)	Description	Where Used
Gauges					
BDPG-15	****	500	175	DPG-15 with mounting bracket.	H-Series
BDPI-13	1/8"	250	175	Differential pressure indicator with base and bracket.	H-Series
BDPI-25	****	5000	200	DPI-25 with mounting bracket.	ASME
BDPS-25	****	5000	200	DPS-25 with mounting bracket.	ASME
DPG-15	****	500	175	Differential pressure gauge.	H-Series
DPG-15HP	****	800	175	Differential pressure gauge.	M-Series
DPI-13	1/8"	250	175	Differential pressure indicator with base, 10 PSID - visual only.	H-Series
DPI-25	****	5000	200	2-1/2" dial, differential pressure gauge, range 0-10 PSID.	ASME
DPS-25	****	5000	200	DPI-25 above with SPST reed switch, 0.25 amp Maximum current.	ASME
KBDPG-15	****	250	200	DPG-15 Kit includes all fittings, tubing, and mounting bracket necessary for wall mounting, or to install gauge on ASME housing.	H-Series; ASME
KBDPI-13	1/8"	250	200	DPI-13 Kit w / fittings and tubing.	H-Series
KBDPI-25	****	250	200	DPI-25 Kit includes all fittings, tubing, and mounting bracket necessary for wall mounting, or to install gauge on ASME housing.	ASME
KBDPS-25	****	250	200	Kit includes all fittings, tubing, and mounting bracket necessary to install gauge on ASME housing.	ASME
KDPS	****	****	****	Reed Switch for DPG-15HP and KBDPG-15.	M-Series
2003	****	****	****	DPI-13 spare parts (cap screws, bracket, shell, spring, piston, diaphragm)	H-Series
2095	****	****	****	DPI hole block off kit. Blocks off DPI sensing port air flow if DPI is no longer desired.	H-Series
Drains					
AD-12	1/8" Fe- male Pipe- Away	250	175	Float actuated automatic drain valve; point of use; non-emulsion liquids.	H-Series
ADS-50	1/2"	250	450	All stainless steel automatic drain trap rated at 120 gallons per hour with 0.10 orifice.	H-Series; ASME
ADT-50	1/2"	150	450	Float actuated automatic drain trap with S.S. internals.	H-Series; ASME
DL1-ADT50	1/4"	150	450	Float actuated automatic drain trap with S.S. internals.	W/ H-Series
DL1-TV25	1/4"	300	230	Timed solenoid drain valve; 6 ft. grounded power cord; Open Time: 1.2 sec - 2 min; Closed Time: 30 sec-45 min.	W/ H-Series
DL1-VS50	1/4"	150	125	Float actuated visual sump drain.	W/ H-Series
DL1-ZLD013	1/4"	232	140	Zero Loss Drain - 3600 scfm.	W/ H-Series
DL2-ADT50	1/2"	150	450	Float actuated automatic drain trap with S.S. internals.	W/ H-Series
DL2-TV50	1/2"	300	210	Timed solenoid drain valve; 6 ft. grounded power cord; Open Time: 1.2 sec - 2 min; Closed Time: 30 sec-45 min.	W/ H-Series
DL2-VS50	1/2"	150	125	Float actuated visual sump drain.	W/ H-Series
DL2-ZLD013	1/2"	250	140	Zero Loss Drain - 3600 scfm.	W/ H-Series
MS-50	1/2"	250	175	Metal sump with AD-12 installed.	H-Series; ASME
	****	****	****	Timer; Open Time: 1-10 sec; Closed Time: 1-60 min; includes manual override auto/off switch.	H-Series; ASME
TD-50	1/2"	600	150	Timed drain valve; motorized S.S. ball valve; 8 ft. grounded power cord; bronze body; 120V AC; 60Hz; Open Time: 5 seconds; Closed Time: 1-50 minutes.	H-Series; ASME

Model Number	Port (NPT)	Max Press. (PSIG)	Max Temp. (F)	Description	Where Used
TV-25	1/4"	300	230	Timed solenoid drain valve; 6 ft. grounded power cord; Open Time: 0.5 sec - 10 sec; Closed Time: 30 sec-45 min.	H-Series; ASME
TV-25-700	1/4"	700	210	High Pressure Timed solenoid drain valve; 6 ft. grounded power cord; brass body; ruby plunger seal; Open Time: 0.5 sec - 10 sec; Closed Time: 30 sec-45 min.	H-Series; ASME
	1/4"	200	185	Timed solenoid drain valve; 6 ft. grounded power cord; stainless steel body; Open Time: 0.5 sec - 10 sec; Closed Time: 30 sec-45 min.	H-Series; ASME
TV-50	1/2"	300	210	Timed solenoid drain valve; 6 ft. grounded power cord; Open Time: 0.5 sec - 10 sec; Closed Time: 30 sec-45 min.	H-Series
	1/2"	300	210	Timed solenoid drain valve with strainer; 6 ft. grounded power cord; Open Time: 0.5 sec - 10 sec; Closed Time: 30 sec - 45 min.	H-Series; ASME
VS-50	1/2"	150	125	Float actuated visual sump drain.	H-Series
	****	****	****	240 V Coil Kit and Cord Set for TV-25/TV-50	TV-25/TV-50
2161	****	****	****	Coil only for TV-25/TV-50	TV-25/TV-510
	****	****	****	1/2" NPT Ball Valve w/plate (Replacement valve for old TD-50)	TD-50
23105	****	****	****	1/4" NPT STRAINER FOR TV-25	TV-25
23106	****	****	****	1/2" NPT STRAINER FOR TV-50	TV-50
	1/2"	250	140	Zero Loss Drain - 3600 scfm.	H-Series; ASME
ZLD-006	3/8"	232	140	Zero Loss Drain - 424 scfm	H-Series; ASME
ZLD-013	1/2"	232	140	Zero Loss Drain - 1413 scfm	H-Series; ASME
ZLD-013-230V	1/2"	232	140	Zero Loss Drain - 230 VAC - 1413 scfm	H-Series; ASME
ZLD-023	1/2"	232	140	Zero Loss Drain - 2472 scfm	H-Series; ASME
ZLD-100	1/2"	232	140	Zero Loss Drain - 10594 scfm	H-Series; ASME
ZLD-330	1/2"	232	140	Zero Loss Drain - 35315 scfm	H-Series; ASME
ZLD-AV	1/2"	250	140	Vent adaptor for old ZLD-10 and ZLD-20.	H-Series; ASME
ZLD-RK	****	****	****	Service kit for old ZLD-10 and ZLD-20.	H-Series; ASME
2158	****	****	****	Drain Kit for QN*N	QN*N
Mounting Brackets/Adaptor Kits					
BK-3	****	****	****	Mounting bracket for 3/4" and 1" H-Series & M-Series housings.	H-Series; M-Series
BK-M	****	****	****	Mounting bracket for H-Series housings up to 1/2" NPT; FFC-110 and QN_N	H-Series; instrumentation
DF-1	1/8"-1/2"	****	****	Drain Fitting Adaptor for MS-50, ZLD-10, and ZLD-20.	H-Series
EBD-12	1/8"	****	****	Brass drain bushing kit--Fits all H-Series and older models.	H-Series
ESD-12	1/8"	****	****	Stainless Steel drain bushing kit; Fits all H-Series and older models.	H-Series
KV-2A	****	****	****	Element frame kit (Element: 51-280).	ASME
KV-2SA	****	****	****	Element frame kit (Element: 51-280), stainless steel	ASME
KV-5A	****	****	****	Element frame kit (Element: 85-250).	ASME
KV-5SA	****	****	****	Element frame kit (Element: 85-250), stainless steel	ASME
KV-6A	****	****	****	Element frame kit (Element: 85-360).	ASME
KV-6SA	****	****	****	Element frame kit (Element: 85-360), stainless steel	ASME
MB-2	****	****	****	Steel Mounting Bracket for P1N Housing & M-Series (1/4"-1/2" NPT)	Instrumentation; M-Series
MBS-1	****	****	****	A5R/A1R, S5R/S1R, FFC-116	Instrumentation
MBS-2	****	****	****	Steel Mounting Bracket for FFC-112 Housing	Instrumentation
2222FFC	****	****	****	SS Mounting Bracket for FFC-110 & FFC-110L, FFC-113, FFC-213, LPGR	Instrumentation; FFC

Finite Accessories - Drip Leg Kit

This contamination can cause components such as valves, cylinders, and air motors to fail prematurely. In addition, water can carry rust and pipe scale into critical components causing them to plug. While air dryers are the best solution for ridding a system of water, they may be too costly or difficult to install for some point-of-use applications. A very reliable alternative to an air dryer is the combination of our new Drip Leg Kits and coalescing filters. This combination efficiently removes both free water and water aerosols, providing you with an economical solution for all of your point-of-use applications.

Every compressed air system is faced with the problem of free water, water aerosols and water vapor.

Product Features:

- Connection sizes: 1/4" - 1/2" NPT
- Maximum Pressure: 250 PSIG
- Maximum Temperature: 450° F
- Drain Port: 1/8" NPT with standard
- 4 different types of drains available
- Compact and lightweight

Typical Applications:

- Compressor/Dryer Installations
- Water Removal
- Air Blow-offs
- Point-of-use Pneumatic Applications
- All Air Drops
- New Equipment Installations

Common Point-of-use Application:

Drip Leg Kit Typical Installation
Fully assembled kit includes:

- Fittings
- Ball Valve
- Drain

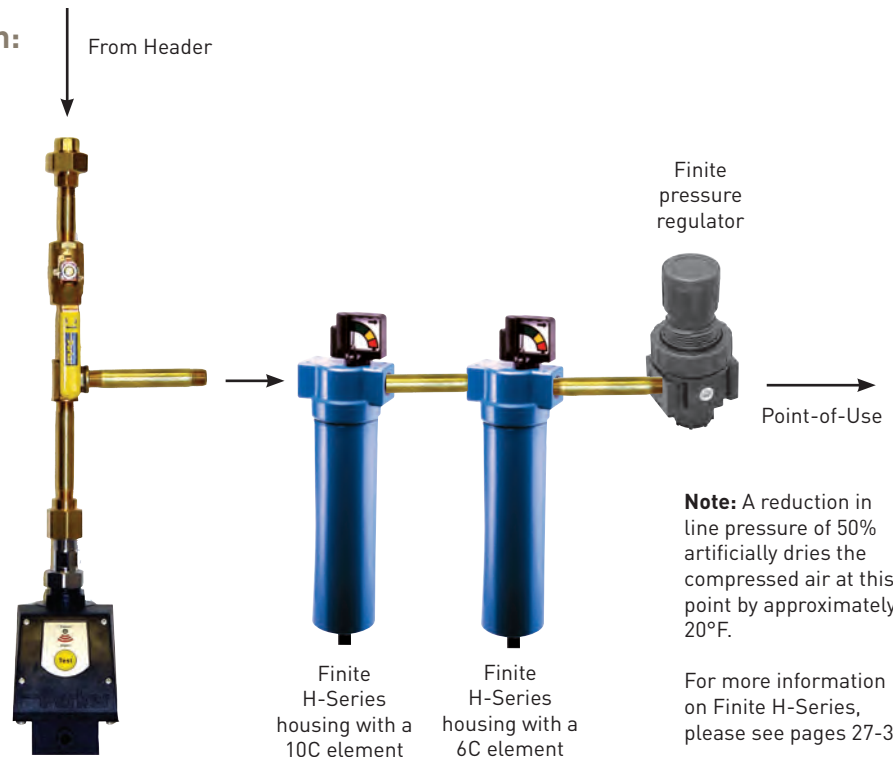

Finite Accessories - Drip Leg Kit Specifications

Automatic Drain Trap

DL1-ADT50 (1/4" NPT)
DL2-ADT50 (1/2" NPT)

This automatic drain trap is ideal for highly contaminated systems.

- Pressure to 150 PSIG
- Temperature to 450°F
- 1/4" or 1/2" NPT Connections
- Kit includes fittings, ball valve, and ADT-50 drain



Timed Solenoid Drain Valve

DL1-TV25 (1/4" NPT)
DL2-TV50 (1/2" NPT)

This timed solenoid drain valve is ideal when you want to vary the drain frequency.

- Pressure to 250 PSIG
- Temperature to 230°F (TV-25)
210°F (TV-50)
- 1/4" or 1/2" NPT Connections
- Kit includes fittings, ball valve, and timed solenoid drain



Visual Sump Drain

DL1-VS50 (1/4" NPT)
DL2-VS50 (1/2" NPT)

This visual sump drain is ideal when visual inspection is required.

- Pressure to 150 PSIG
- Temperature to 125°F
- 1/4" or 1/2" NPT Connections
- Kit includes fittings, ball valve, and VS-50 drain



Zero Loss Drain

DL1-ZLD013 (1/4" NPT)
DL2-ZLD013 (1/2" NPT)

This zero loss drain is ideal for conserving compressed air energy.

- Pressure to 232 PSIG
- Temperature to 140°F
- 1/4" or 1/2" NPT Connections
- Kit includes fittings, ball valve, and ZLD drain

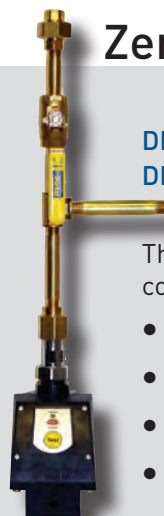

Technical Data

	Model				
	ZLD-006	ZLD-013	ZLD-023	ZLD-100	ZLD-330
Flow rate					
Compressor aftercooler (SCFM)	—	141	247	1059	3531
Refrigeration dryer (SCFM)	—	282	494	2118	7062
Filter² (SCFM)	424	1410	2470	10590	35310
Nominal flow rate (ft³/h)	0.035	0.074	0.13	0.57	1.87
Operating pressure range	3-232 psig				
Temperature range	35-140°F				
Supply voltage³ (selectable)	115 V—60 Hz 50-60 Hz, 24 Vac/50-60 HZ 50-60 Hz/24 V DC (available on request)				
Potential-free contact⁴	—		110 V DV, 250 V AV 1A 30 W DC, 250 VA AC		
Power Consumption:	Standby	1 VA		1.8 VA	
	Valve operation	6 VA		6.8 VA	
Protection class	IP 65				

- 1 at 14.5 psi and 68°F, operating pressure 100 psi, suction: compressor or 77°F at 60% relative humidity, compressed air outlet temperature at aftercooler 95°F; refrigeration dryer dewpoint 37.4°F.
- 2 Main condensate already drained from aftercooler or refrigeration dryer; only for residual oil or low condensate volumes arising from condensation.
- 3 Magnetic valve connector type B industrial standard (0.43 in) 2+PE.
- 4 Magnetic valve connector type C industrial standard (0.37 in) 3+PE.



Dimension Drawings

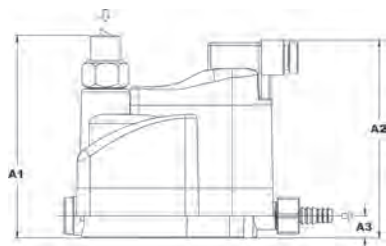

ZLD-006

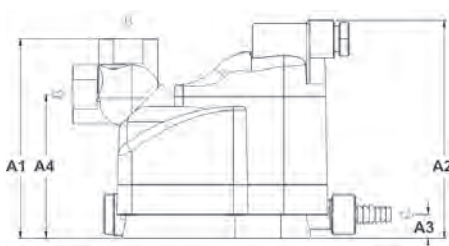

ZLD-013

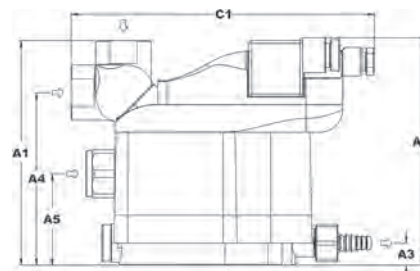

ZLD-023, -100, -330

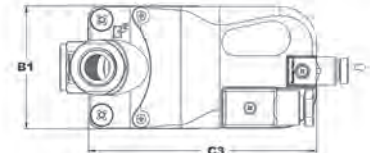
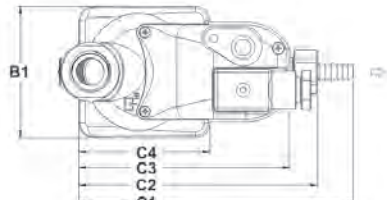
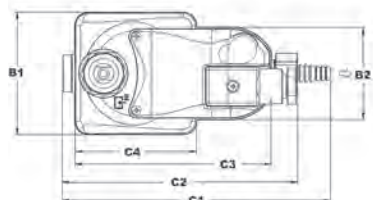

	Model				
	ZLD-006	ZLD-013	ZLD-023	ZLD-100	ZLD-330
Dimensions (in)					
A1	4.33	3.97	4.80	5.39	7.75
A2	4.21	4.37	4.84	5.39	7.79
A3	0.47	0.47	0.47	0.47	0.47
A4	—	2.87	3.66	4.25	6.61
A5	—	—	1.94	1.94	1.94
B1	2.63	2.63	2.63	2.63	2.63
B2	1.96	—	—	—	—
C1	5.74	5.47	6.45	6.45	6.45
C2	5.03	4.76	—	—	—
C3	4.17	4.21	4.88	4.88	4.88
C4	1.73	2.63	—	—	—
Weight (lbs.)	1.10	1.32	2.20	2.42	3.30

NPT connections at condensate inlet				
Top inlet	3/8"		1/2"	
Vent	Integrated in connection		1/8"	
Bottom vent	—	—	1/2"	
Connection at condensate outlet				
3/8" BSP or 0.3–0.4 in hose tail				

Zero Air Loss Condensate Drains by Finite®





What is a zero air loss condensate drain?

Finite's zero air loss condensate drains are designed for economical removal of unwanted water, oil emulsions, and other liquids. These drains will only open when liquid is present and will not allow any compressed air to escape from the system.

Why are they needed?

- Condensate is always present in a compressed air system.
- If condensate is not removed from a compressed air system, it will adversely affect product quality and production efficiency and will eventually lead to costly downtime.

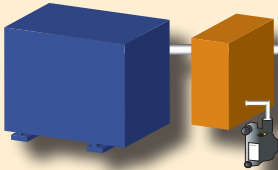
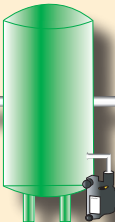
Where are condensate drains used?

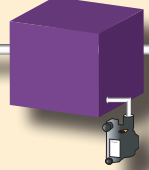
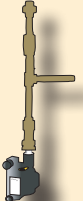
				
Compressor with Aftercooler	Receiver Tank	Filter	Air Dryer	Drip Leg
Removes the condensate that is collected after the air cools in the aftercooler	Removes the condensate that is collected when the air cools inside of the receiver tank	Removes the condensate that is collected in the filter bowl	Removes the condensate that is collected in the air dryer	Point-of-use applications: removes the condensate from compressed air pipes in a plant

How does the Finite Zero Air Loss Condensate drain compare to other drains?

Condensate Removal Method	Disadvantages of Other Drains	Advantages of Finite's ZLD
Manual Drain (operators must manually open valves to discharge condensate)	<ul style="list-style-type: none"> • Requires constant attention • Always leads to excess air loss because air escapes when the valve is left open to drain the condensate 	<ul style="list-style-type: none"> • Automatically drains condensate • When a minimum level of condensate is reached, the valve closes in time before compressed air can escape
	<ul style="list-style-type: none"> • Float is susceptible to blockage from particulate contamination in condensate • Often sticks in open (leaks excess air) or closed position (no condensate is drained) 	<ul style="list-style-type: none"> • Includes an integrated dirt screen between the level measurement and drain valve to protect the diaphragm valve • Particulate contamination is removed by the integrated dirt screen before fouling the moving parts
Solenoid Operated Drain Valves (uses a timer which allows user to open and close valve at specified intervals)	<ul style="list-style-type: none"> • The period for which the valve is open might not be long enough for adequate drainage of accumulated condensate • The valve will operate even if little or no condensate is present, resulting in air loss • Often requires a strainer to remove particulate contamination which can block the inlet and outlet ports 	<ul style="list-style-type: none"> • Drain will remove condensate when liquid reaches the high level sensor • The drain will not operate until the liquid level reaches the high level sensor • Particulate contamination is removed by the integrated dirt screen before fouling the outlet port

How does this drain work?

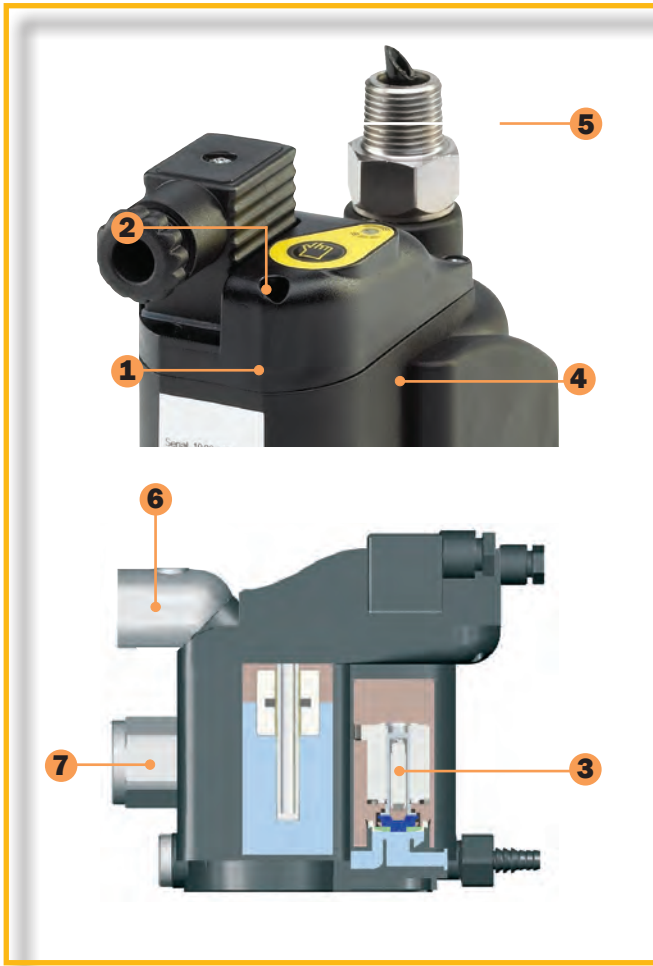

- 1 This collection vessel stores condensate until it is drained away.
- 2 This electronic level controller continuously monitors the liquid level inside the drain.
- 3 This depicts the electric drain valve. As soon as the electronic level controller detects a buildup of liquid, the valve opens and condensate is drained. When a minimum liquid level is reached, the valve closes before compressed air can escape.
- 4 The diaphragm valve ensures that contaminants are flushed out and that the condensate is prevented from forming an emulsion that would need expensive condensate treatment.
- 5 If an error has occurred (i.e. if the condensate cannot be discharged), the electronic control board (5) of the condensate drain generates an alarm signal. This allows timely detection of a problem and helps avoid excessive costs associated with condensate carryover to downstream components.
- 6 Unique swivel inlet connection for easy adaptability on ZLD-013 and ZLD-023. This allows the condensate line to be connected from the top or the rear. The ZLD-006 has a fixed inlet port with dynamic seal which allows the filter bowl to be removed while the drain is attached (not shown).
- 7 An additional liquid inlet on the ZLD-023 allows for the connection of a balance or vent line. This provides new connections so that condensate can no longer back up into the feed lines.

The cost of compressed air when using a timed drain valve

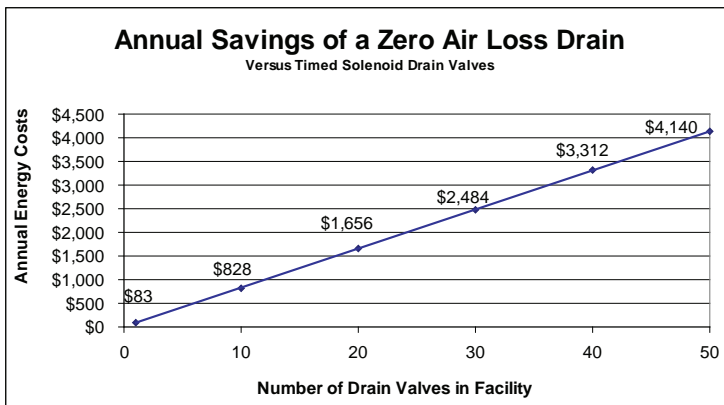

The annual cost of compressed air was calculated using data from the U.S. Department of Energy and several compressed air consultants. The average annual energy cost to maintain a compressed air system is \$0.23 per 1000 ft³. If a timed solenoid drain valve opens 3-4 times per hour, the cost of the wasted air will be \$80 per valve, per year.

Finite's Zero Loss Drains don't waste any compressed air and have a payback of approximately 6 months - 1 year.

Easy installation and servicing!

Oil and Water Indicators



Find out if you have oil or water in your compressed air lines!

Finite's new disposable indicators are an easy way to detect the presence of liquid (water or oil) in a compressed air system. The indicators will change from white to red when the respective liquid is present and provides peace-of-mind for critical applications throughout a facility.

KSDS-W: Detects liquid water.

KSDS-O: Detects liquid oil.

Specifications:

Part Number	Connection Size	Max. Pressure	Max. Temp.	Exhaust Flow @ 100 PSIG	Length	Replacement Element
KSDS-W	1/8" NPT	100 PSIG	125° F	0.16 SCFM	4.37 in.	SDN-W
KSDS-O	1/8" NPT	100 PSIG	125° F	0.16 SCFM	4.37 in.	SDN-O

Installation:

Liquid (water or oil) indicators should be installed throughout a facility at all critical point-of-use applications. They should be connected to the main compressed air line via an 1/8" NPT port, in an area with adequate visibility. Indicators should be located downstream of a coalescing filter and upstream of a point-of-use piece of equipment.

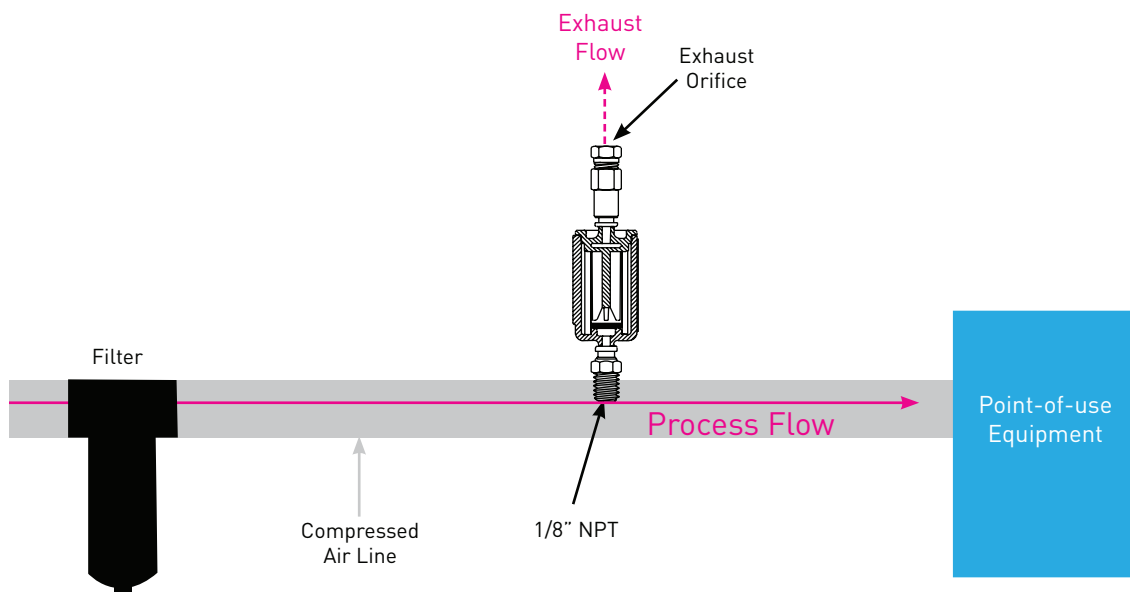

Offer of Sale

1. Definitions. As used herein, the following terms have the meanings indicated.

Buyer: means any customer receiving a Quote for Products from Seller.

Goods: means any tangible part, system or component to be supplied by the Seller.

Products: means the Goods, Services and/or Software as described in a Quote provided by the Seller.

Quote: means the offer or proposal made by Seller to Buyer for the supply of Products.

Seller: means Parker-Hannifin Corporation, including all divisions and businesses thereof.

Services: means any services to be supplied by the Seller.

Software: means any software related to the Products, whether embedded or separately downloaded.

Terms: means the terms and conditions of this Offer of Sale or any newer version of the same as published by Seller electronically at www.parker.com/saleterms.

2. Terms. All sales of Products by Seller are contingent upon, and will be governed by, these Terms and, these Terms are incorporated into any Quote provided by Seller to any Buyer. Buyer's order for any Products whether communicated to Seller verbally, in writing, by electronic data interface or other electronic commerce, shall constitute acceptance of these Terms. Seller objects to any contrary or additional terms or conditions of Buyer. Reference in Seller's order acknowledgement to Buyer's purchase order or purchase order number shall in no way constitute an acceptance of any of Buyer's terms of purchase. No modification to these Terms will be binding on Seller unless agreed to in writing and signed by an authorized representative of Seller.

3. Price; Payment. The Products set forth in Seller's Quote are offered for sale at the prices indicated in Seller's Quote. Unless otherwise specifically stated in Seller's Quote, prices are valid for thirty (30) days and do not include any sales, use, or other taxes or duties. Seller reserves the right to modify prices at any time to adjust for any raw material price fluctuations. Unless otherwise specified by Seller, all prices are F.C.A. Seller's facility (INCOTERMS 2010). All sales are contingent upon credit approval and payment for all purchases is due thirty (30) days from the date of invoice (or such date as may be specified in the Quote). Unpaid invoices beyond the specified payment date incur interest at the rate of 1.5% per month or the maximum allowable rate under applicable law.

4. Shipment; Delivery; Title and Risk of Loss. All delivery dates are approximate. Seller is not responsible for damages resulting from any delay. Regardless of the manner of shipment, delivery occurs and title and risk of loss or damage pass to Buyer, upon placement of the Products with the shipment carrier at Seller's facility. Unless otherwise agreed, Seller may exercise its judgment in choosing the carrier and means of delivery. No deferral of shipment at Buyers' request beyond the respective indicated shipping date will be made except on terms that will indemnify, defend and hold Seller harmless against all loss and additional expense. Buyer shall be responsible for any additional shipping charges incurred by Seller due to Buyer's acts or omissions.

5. Warranty. The warranty related to the Products is as follows: (i) Goods are warranted against defects in material or workmanship for a period of twelve (12) months from the date of shipment; (ii) Services shall be performed in accordance with generally accepted practices and using the degree of care and skill that is ordinarily exercised and customary in the field to which the Services pertain and are warranted for a period of six (6) months from the completion of the Services by Seller; and (iii) Software is only warranted to perform in accordance with applicable specifications provided by Seller to Buyer for ninety (90) days from the date of delivery or, when downloaded by a Buyer or end-user, from the date of the initial download. All prices are based upon the exclusive limited warranty stated above, and upon the following disclaimer:

DISCLAIMER OF WARRANTY: THIS WARRANTY IS THE SOLE AND ENTIRE WARRANTY PERTAINING TO PRODUCTS. SELLER DISCLAIMS ALL OTHER WARRANTIES, EXPRESS AND IMPLIED, INCLUDING DESIGN, NONINFRINGEMENT, MERCHANTABILITY, AND FITNESS FOR A PARTICULAR PURPOSE. SELLER DOES NOT WARRANT THAT THE SOFTWARE IS ERROR-FREE OR FAULT-TOLERANT, OR THAT BUYER'S USE THEREOF

WILL BE SECURE OR UNINTERRUPTED. BUYER AGREES AND ACKNOWLEDGES THAT UNLESS OTHERWISE AUTHORIZED IN WRITING BY SELLER THE SOFTWARE SHALL NOT BE USED IN CONNECTION WITH HAZARDOUS OR HIGH RISK ACTIVITIES OR ENVIRONMENTS. EXCEPT AS EXPRESSLY STATED HEREIN, ALL PRODUCTS ARE PROVIDED "AS IS".

6. Claims; Commencement of Actions. Buyer shall promptly inspect all Products upon receipt. No claims for shortages will be allowed unless reported to the Seller within ten (10) days of delivery. Buyer shall notify Seller of any alleged breach of warranty within thirty (30) days after the date the non-conformance is or should have been discovered by Buyer. Any claim or action against Seller based upon breach of contract or any other theory, including tort, negligence, or otherwise must be commenced within twelve (12) months from the date of the alleged breach or other alleged event, without regard to the date of discovery. *If product is returned for a refund, a 30% restock fee may apply.*

7. LIMITATION OF LIABILITY. IN THE EVENT OF A BREACH OF WARRANTY, SELLER WILL, AT ITS OPTION, REPAIR OR REPLACE THE NON-CONFORMING PRODUCT, RE-PERFORM THE SERVICES, OR REFUND THE PURCHASE PRICE PAID WITHIN A REASONABLE PERIOD OF TIME. **IN NO EVENT IS SELLER LIABLE FOR ANY SPECIAL, INDIRECT, INCIDENTAL OR CONSEQUENTIAL DAMAGES ARISING OUT OF, OR AS THE RESULT OF, THE SALE, DELIVERY, NON-DELIVERY, SERVICING, NON-COMPLETION OF SERVICES, USE, LOSS OF USE OF, OR INABILITY TO USE THE PRODUCTS OR ANY PART THEREOF, LOSS OF DATA, IDENTITY, PRIVACY, OR CONFIDENTIALITY, OR FOR ANY CHARGES OR EXPENSES OF ANY NATURE INCURRED WITHOUT SELLER'S WRITTEN CONSENT, WHETHER BASED IN CONTRACT, TORT OR OTHER LEGAL THEORY. IN NO EVENT SHALL SELLER'S LIABILITY UNDER ANY CLAIM MADE BY BUYER EXCEED THE PURCHASE PRICE PAID FOR THE PRODUCTS.**

8. Loss to Buyer's Property. Any designs, tools, patterns, materials, drawings, confidential information or equipment furnished by Buyer or any other items which are or become Buyer's property, will be considered obsolete and may be destroyed by Seller after two (2) consecutive years have elapsed without Buyer ordering the Products manufactured using such property. Seller shall not be responsible for any loss or damage to such property while it is in Seller's possession or control.

9. Special Tooling. Special Tooling includes but is not limited to tooling, jigs, fixtures and associated manufacturing equipment acquired or necessary to manufacture Products. A tooling charge may be imposed for any Special Tooling. Such Special Tooling shall be and remain Seller's property notwithstanding payment of any charges by Buyer. In no event will Buyer acquire any interest in Special Tooling belonging to Seller that is utilized in the manufacture of the Products, even if such Special Tooling has been specially converted or adapted for such manufacture and notwithstanding any charges paid by Buyer. Unless otherwise agreed, Seller has the right to alter, discard or otherwise dispose of any Special Tooling or other property in its sole discretion at any time.

10. Security Interest. To secure payment of all sums due, Seller retains a security interest in all Products delivered to Buyer and, Buyer's acceptance of these Terms is deemed to be a Security Agreement under the Uniform Commercial Code. Buyer authorizes Seller as its attorney to execute and file on Buyer's behalf all documents Seller deems necessary to perfect its security interest.

11. User Responsibility. The Buyer through its own analysis and testing, is solely responsible for making the final selection of the Products and assuring that all performance, endurance, maintenance, safety and warning requirements of the application of the Products are met. The Buyer must analyze all aspects of the application and follow applicable industry standards, specifications, and other technical information provided with the Product. If Seller provides Product options based upon data or specifications provided by the Buyer, the Buyer is responsible for determining that such data and specifications are suitable and sufficient for all applications and reasonably foreseeable uses of the Products. In the event the Buyer is not the end-user, Buyer will ensure such end-user complies with this paragraph.

12. Use of Products, Indemnity by Buyer. Buyer shall comply with all instructions, guides and specifications provided by Seller with the Products. Unauthorized Uses. If Buyer uses or resells the Products for any uses prohibited in Seller's instructions, guides or specifications, or Buyer otherwise fails to comply with Seller's instructions, guides and specifications,

Offer of Sale (continued)

Buyer acknowledges that any such use, resale, or non-compliance is at Buyer's sole risk. Buyer shall indemnify, defend, and hold Seller harmless from any losses, claims, liabilities, damages, lawsuits, judgments and costs (including attorney fees and defense costs), whether for personal injury, property damage, intellectual property infringement or any other claim, brought by or incurred by Buyer, Buyer's employees, or any other person, arising out of: (a) improper selection, application, design, specification or other misuse of Products provided by Seller; (b) any act or omission, negligent or otherwise, of Buyer; (c) Seller's use of patterns, tooling, equipment, plans, drawings, designs or specifications or other information or things furnished by Buyer; (d) damage to the Products from an external cause, repair or attempted repair by anyone other than Seller, failure to follow instructions, guides and specifications provided by Seller, use with goods not provided by Seller, or opening, modifying, deconstructing or tampering with the Products for any reason; or (e) Buyer's failure to comply with these Terms. Seller shall not indemnify Buyer under any circumstance except as otherwise provided in these Terms.

13. Cancellations and Changes. Buyer may not cancel or modify any order for any reason, except with Seller's written consent and upon terms that will indemnify, defend and hold Seller harmless against all direct, incidental and consequential loss or damage. Seller, at any time, may change Product features, specifications, designs and availability. *Order cancellation fee of 15% may apply.*

14. Limitation on Assignment. Buyer may not assign its rights or obligations without the prior written consent of Seller.

15. Force Majeure. Seller does not assume the risk and is not liable for delay or failure to perform any of Seller's obligations by reason of events or circumstances beyond its reasonable control ("Events of Force Majeure"). Events of Force Majeure shall include without limitation: accidents, strikes or labor disputes, acts of any government or government agency, acts of nature, delays or failures in delivery from carriers or suppliers, shortages of materials, or any other cause beyond Seller's reasonable control.

16. Waiver and Severability. Failure to enforce any provision of these Terms will not invalidate that provision; nor will any such failure prejudice Seller's right to enforce that provision in the future. Invalidation of any provision of these Terms by legislation or other rule of law shall not invalidate any other provision herein and, the remaining provisions will remain in full force and effect.

17. Termination. Seller may terminate any agreement governed by or arising from these Terms for any reason and at any time by giving Buyer thirty (30) days prior written notice. Seller may immediately terminate, in writing, if Buyer: (a) breaches any provision of these Terms (b) appoints a trustee, receiver or custodian for all or any part of Buyer's property (c) files a petition for relief in bankruptcy on its own behalf, or one if filed by a third party (d) makes an assignment for the benefit of creditors; or (e) dissolves its business or liquidates all or a majority of its assets.

18. Ownership of Software. Seller retains ownership of all Software supplied to Buyer hereunder. In no event shall Buyer obtain any greater right in and to the Software than a right in the nature of a license limited to the use thereof and subject to compliance with any other terms provided with the Software.

19. Indemnity for Infringement of Intellectual Property Rights. Seller is not liable for infringement of any patents, trademarks, copyrights, trade dress, trade secrets or similar rights ("Intellectual Property Rights") except as provided in this Section. Seller will defend at its expense and will pay the cost of any settlement or damages awarded in an action brought against Buyer based on a third party claim that one or more of the Products sold hereunder infringes the Intellectual Property Rights of a third party in the country of delivery of the Products by the Seller to the Buyer. Seller's obligation to defend and indemnify Buyer is contingent on Buyer notifying Seller within ten (10) days after Buyer becomes aware of any such claim, and Seller having sole control over the defense of the claim including all negotiations for settlement or compromise. If one or more Products sold hereunder is subject to such a claim, Seller may, at its sole expense and option, procure for Buyer the right to continue using the Products, replace or modify the Products so as to render them non-infringing, or offer to accept return of the Products and refund the purchase price less a reasonable allowance for depreciation. Seller has no obligation or liability for any claim of infringement: (i) arising from information provided by Buyer; or (ii) directed to any Products provided hereunder for which the designs are specified in whole or part by Buyer; or (iii) resulting from the modification,

combination or use in a system of any Products provided hereunder. The foregoing provisions of this Section constitute Seller's sole and exclusive liability and Buyer's sole and exclusive remedy for such claims of infringement of Intellectual Property Rights.

20. Governing Law. These Terms and the sale and delivery of all Products are deemed to have taken place in, and shall be governed and construed in accordance with, the laws of the State of Ohio, as applicable to contracts executed and wholly performed therein and without regard to conflicts of laws principles. Buyer irrevocably agrees and consents to the exclusive jurisdiction and venue of the courts of Cuyahoga County, Ohio with respect to any dispute, controversy or claim arising out of or relating to the sale and delivery of the Products.

21. Entire Agreement. These Terms, along with the terms set forth in the main body of any Quote, forms the entire agreement between the Buyer and Seller and constitutes the final, complete and exclusive expression of the terms of sale. In the event of a conflict between any term set forth in the main body of a Quote and these Terms, the terms set forth in the main body of the Quote shall prevail. All prior or contemporaneous written or oral agreements or negotiations with respect to the subject matter shall have no effect. These Terms may not be modified unless in writing and signed by an authorized representative of Seller.

22. Compliance with Laws. Buyer agrees to comply with all applicable laws, regulations, and industry and professional standards, including those of the United States of America, and the country or countries in which Buyer may operate, including without limitation the U.S. Foreign Corrupt Practices Act ("FCPA"), the U.S. Anti-Kickback Act ("Anti-Kickback Act"), U.S. and E.U. export control and sanctions laws ("Export Laws"), the U.S. Food Drug and Cosmetic Act ("FDCA"), and the rules and regulations promulgated by the U.S. Food and Drug Administration ("FDA"), each as currently amended. Buyer agrees to indemnify, defend, and hold harmless Seller from the consequences of any violation of such laws, regulations and standards by Buyer, its employees or agents. Buyer acknowledges that it is familiar with all applicable provisions of the FCPA, the Anti-Kickback Act, Export Laws, the FDCA and the FDA and certifies that Buyer will adhere to the requirements thereof and not take any action that would make Seller violate such requirements. Buyer represents and agrees that Buyer will not make any payment or give anything of value, directly or indirectly, to any governmental official, foreign political party or official thereof, candidate for foreign political office, or commercial entity or person, for any improper purpose, including the purpose of influencing such person to purchase Products or otherwise benefit the business of Seller. Buyer further represents and agrees that it will not receive, use, service, transfer or ship any Product from Seller in a manner or for a purpose that violates Export Laws or would cause Seller to be in violation of Export Laws.

Notes

Notes



The Hope Group Branch Locations

Your complete source for quality tube fittings, hose & hose fittings, brass & composite fittings, quick-disconnect couplings, valves and assembly tools, locally available from a worldwide network of authorized distributors.

Fittings:

Available in inch and metric sizes covering SAE, BSP, DIN, GAZ, JIS and ISO thread configurations, manufactured from steel, stainless steel, brass, aluminum, nylon and thermoplastic.

Hose, Tubing and Bundles:

Available in a wide variety of sizes and materials including rubber, wire-reinforced, thermoplastic, hybrid and custom compounds.

Worldwide Availability:

Parker operates Fluid Connectors manufacturing locations and sales offices throughout North America, South America, Europe and Asia-Pacific.

For information, call

508-393-7660

Massachusetts

Fitchburg

Parker Store
58 Crawford Street
Tel: 978-342-6817
Fax: 978-345-7604

Woburn

Parker Store
134B New Boston Street
Tel: 781-404-5858
Fax: 351-351-2777

Weymouth

Parker Store
50 Finnell Drive, Unit 12-14
Tel: 781-803-2572
Fax: 781-812-2641

Rhode Island

Cranston

Parker Store
215 Niantic Avenue
Tel: 401-943-1577
Fax: 401-943-8808

Connecticut

North Haven

The Hope Group - No. Haven
350 Sackett Point Road
Tel: 203-269-1299
Fax: 203-891-7649

Maine

Bangor

Parker Store
257 Perry Road
Tel: 207-942-7475
Fax: 207-941-9875

Lewiston

Parker Store
14 Enterprise Street
Tel: 207-783-9108
Fax: 207-782-8634

South Portland

Parker Store
5 Wallace Avenue
Tel: 207-774-6266
Fax: 207-774-4735

New Hampshire

Manchester

Parker Store
880 Candia Road
Tel: 603-622-4998
Fax: 603-622-4667



The Hope Group
70 Bearfoot Road
Northborough, MA 01532

www.thehopegroup.com

Email: sales@thehopegroup.com
Phone: 508-393-7660

ISO 9001/AS9100/AS9120 Certified
ITAR Registered